

CANopen

Cabling and Connector Pin Assignment

CiA Draft Recommendation DR-303-1

Version 1.0

Date: 10 October 1999

Table of Contents

1	Scope	3
2	References	3
2.1	Normative references	3
2.2	Informative references	3
3	Abbreviations and definitions	4
3.1	Abbreviations	4
3.2	Definitions	4
4	Naming convention	5
5	AC and DC parameters	6
5.1	Bus cable and termination resistors	6
5.2	Unterminated stub cable	7
5.3	CAN ground and galvanic isolation	8
6	General purpose connectors	9
6.1	9-pin D-Sub connector	9
6.2	Multipole connector	10
6.3	RJ10 connector	11
6.4	RJ45 connector	12
7	Industrial connectors	13
7.1	5-pin “mini” style connector	13
7.2	5-pin “micro” style connector	14
7.3	Open style connector	15
8	Special purpose connectors	16
8.1	7-pin round connector	16
8.2	8-pin round connector	17
8.3	9-pin round connector	18
8.4	12-pin round flange connector	19
8.5	9-pin flange round T-connector with ID-switch	20

1 Scope

This document recommends cabling and pin assignment of bus connectors for CANopen-based systems. It specifies also the naming conventions for the bus lines, ground lines, and shield connections.

2 References

2.1 Normative references

- ISO 11898 (1993-11): Road vehicles - Interchange of digital information – Controller area network (CAN) for high-speed communication
- DIN 41652: Steckverbinder für die Einschubtechnik
- IEC 60130-9 (1989-9): Connectors for frequencies below 3 MHz – Part 9: Circular connectors for radio and associated sound equipment
- IEC 60947-5-2 (1997-10): Low-voltage switchgear and controlgear – Part 5-2: Control circuit devices and switching elements – Proximity switch
- ANSI/B.93.55M-1981 (R1988): Hydraulic fluid power solenoid piloted industrial valves – Interface dimensions for electrical connectors

2.2 Informative references

- Robert Bosch GmbH: CAN specification 2.0 Part A+B (1991)
- CiA Draft Standard 301 (1999-6): CANopen application layer and communication profile, Version 4.0,
- CiA DS-102 (1994), CAN physical layer for industrial applications

3 Abbreviations and definitions

3.1 Abbreviations

- AC – Alternating Current
- CAN – Controller Area Network
- DC – Direct Current
- EMI – Electromagnetic Interference
- GND – Ground
- SJW – Resynchronization Jump Width
- SHLD – Shield

3.2 Definitions

Bus cable

The bus cable is terminated at both ends by termination resistors.

Stub cable

The stub cable is an un-terminated cable, and should be as short as possible.

Female connector

The female connector may be powered.

Male connectors

The male connector should be not powered. That is the reason why most devices are equipped with male connectors.

4 Naming convention

If connectors are used that are not mentioned in this document, the pins shall be named (either in the accompanying manual or directly on the device) using the following terminology:

Signal description	notation
CAN_L bus line (dominant low)	CAN_L or CAN _{low} or CAN-
CAN_H bus line (dominant high)	CAN_H or CAN _{high} or CAN+
CAN Ground	CAN_GND or CAN _{GND} or Ground or GND
Optional CAN Shield	CAN_SHLD or CAN _{SHIELD} or Shield or SHLD
Optional CAN external positive supply	CAN_V+ or CAN _{V+} or V+ or UC or U _{CAN}
Optional Ground	OPT_GND or GND _{opt} or V- or 0V

5 AC and DC parameters

5.1 Bus cable and termination resistors

The cables, connectors, and termination resistors used in CANopen networks shall meet the requirements defined in ISO 11898. In addition, here are given some guidelines for selecting cables and connectors.

The table below shows some standard values for DC parameters for CANopen networks with less than 64 nodes:

Bus length [m]	Bus cable (1)		Termination resistance [Ω]	Baudrate [Kbit/s]
	Length-related resistance [m Ω /m]	Cross-section [mm ²]		
0 ... 40	70	0.25 ... 0.34	124	1000 at 40 m
40 ... 300	<60	0.34 ... 0.6	150 ... 300	>500 at 100 m
300 ... 600	<40	0.5 ... 0.6	150 ... 300	>100 at 500 m
600 ... 1000	<26	0.75 ... 0.8	150 ... 300	>50 at 1 km

(1) Recommended cable AC parameters: 120- Ω impedance and 5-ns/m specific line delay

For drop cables a wire cross-section of 0.25 to 0.34 mm² would be an appropriate choice in many cases.

Besides the cable resistance, there should also be considered the real resistance of the connectors, if calculating the voltage drop. The transmission resistance of one connector should be in the range of 2.5 to 10 m Ω .

With the assumed values for

minimum dominant value	$V_{\text{diff.out.min}}$	= 1.5 V
minimum differential input resistance	$R_{\text{diff.min}}$	= 20 k Ω
requested differential input voltage	$V_{\text{th.max}}$	= 1.0 V
minimum termination resistance	$R_{\text{T.min}}$	= 118 Ω

The maximum wiring length is given for different bus cables and different number of connected bus nodes in the following table.

Wire cross-section [mm ²]	Maximum length [m] (1)			Maximum length [m] (2)		
	n = 32	n = 64	n = 100	n = 32	n = 64	n = 100
0.25	200	170	150	230	200	170
0.5	360	310	270	420	360	320
0.75	550	470	410	640	550	480

(1) safety margin of 0.2 (2) safety margin of 0.1

Note: If driving more than 64 nodes and/or more than 250 m bus length the accuracy of the V_{CC} supply voltage for the ISO 11898 transceiver is recommended to be 5% or better. You also have to consider the minimum supply voltage of at least 4.75V when driving 50 Ω load, i.e. 64 bus nodes, and at least 4.9V when driving 45 Ω load, i.e. 100 bus nodes.

5.2 Un-terminated stub cable

As a rule of thumb, the following relation can be considered for a single stub cable length:

$$L_u < \frac{t_{\text{PROPSEG}}}{50 \times t_p} \text{ with } t_p = 5 \text{ ns/m and } t_{\text{PROPSEG}} = \text{time segment 1 minus length of SJW}$$

But also the cumulative drop length should be considered, which is given by the following relation:

$$\sum_{i=1}^n L_{ui} < \frac{t_{\text{PROPSEG}}}{10 \times t_p}$$

This effectively leads to a reduction of the maximum trunk cable length by the sum of the actual cumulative drop cable length at a given bit rate. If the above recommendations are met, then the probability of reflection problems is considered to be fairly low.

5.3 CAN ground and galvanic isolation

In general, CAN ground should be connected. However, in complete galvanically isolated CANopen networks CAN ground may be not connected. The user is responsible to guarantee that the common mode rejection of the transceivers has still reached the upper limit.

5.4 External power supply

The recommended output voltage at the optional power supply is $+18\text{VDC} < V+ < +30\text{VDC}$ in order to enable the use of standard power supplies (24VDC).

6 General purpose connectors

6.1 9-pin D-Sub connector

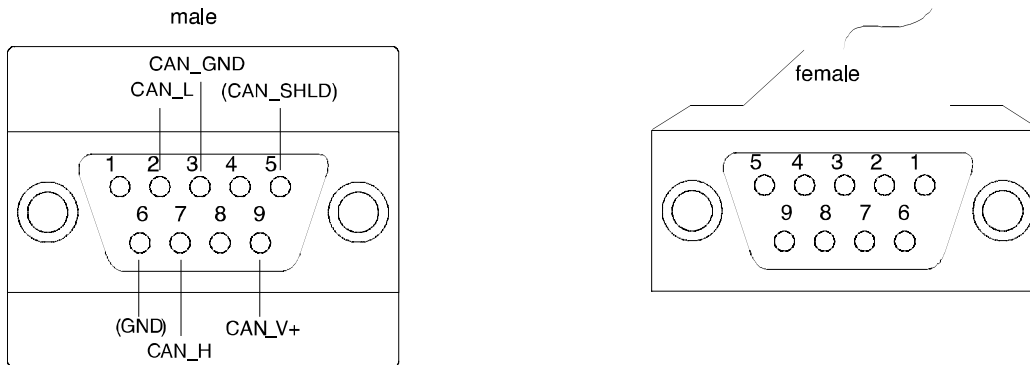

It is recommended to use a 9-pin D-Sub connector (DIN 41652 or corresponding international standard) with the pinning according to CiA DS-102, Version 2.0. For convenience the pinning is repeated here:

Pin	Signal	Description
1	-	Reserved
2	CAN_L	CAN_L bus line (dominant low)
3	CAN_GND	CAN Ground
4	-	Reserved
5	(CAN_SHLD)	Optional CAN Shield
6	(GND)	Optional Ground
7	CAN_H	CAN_H bus line (dominant high)
8	-	Reserved
9	(CAN_V+)	Optional CAN external positive supply (dedicated for supply of transceiver and opto-couplers, if galvanic isolation of the bus node applies)

If 9-pin D-Sub connector is supported, a male connector meeting the above specification shall be provided by the bus node. Within the modules, pin 3 and pin 6 shall be interconnected. Inside of such modules providing two bus connections, and inside the T-connectors, all the pins (including the reserved ones) shall be connected. The intention is that there shall be no interruption of any of the wires in the bus cable, assuming a future specification of the use of the reserved pins.

By using the pin V+ for supplying transceivers in case of galvanic isolation, the necessity of extra local power isolation (e.g. DC/DC-converter) is avoided.

If an error line is needed within a system, then pin 8 shall be used for this purpose.

6.2 Multipole connector

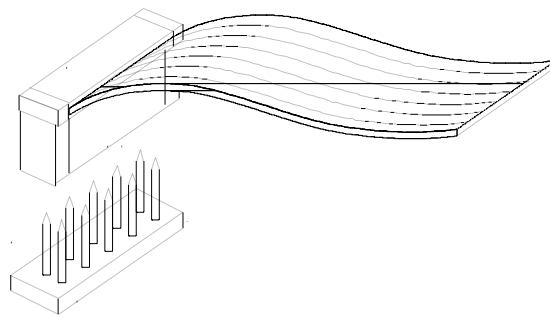

If (5 x 2) multipole connectors are used (e.g. inside EMI protected housings) the following pinning is recommended, as it supports direct connection of the flat cables to 9-pin D-sub connectors:

Pin	Signal	Description
1	-	Reserved
2	(GND)	Optional Ground
3	CAN_L	CAN_L bus line (dominant low)
4	CAN_H	CAN_H bus line (dominant high)
5	CAN_GND	CAN Ground
6	-	Reserved
7	-	Reserved
8	(CAN_V+)	Optional CAN external positive supply
9	-	Reserved
10	-	Reserved

6.3 RJ10 connector

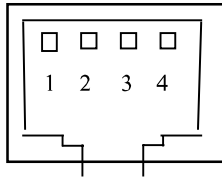

Female

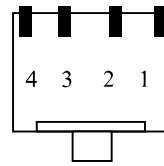

Male

Pin	Signal	Description
1	(CAN_V+)	Optional CAN external positive supply (dedicated for supply of transceiver and optocouplers, if galvanic isolation of the bus node applies)
2	CAN_H	CAN_H bus line (dominant high)
3	CAN_L	CAN_L bus line (dominant low)
4	CAN_GND	Ground / 0 V / V-

6.4 RJ45 connector

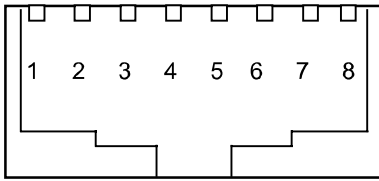

Female

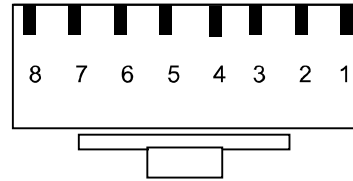

Male

Pin	Signal	Description
1	CAN_H	CAN_H bus line (dominant high)
2	CAN_L	CAN_L bus line (dominant low)
3	CAN_GND	Ground / 0 V / V-
4	-	Reserved
5	-	Reserved
6	(CAN_SHLD)	Optional CAN Shield
7	CAN_GND	Ground / 0 V / V-
8	(CAN_V+)	Optional CAN external positive supply (dedicated for supply of transceiver and opto-couplers, if galvanic isolation of the bus node applies)

The bus node provides the female pins of the connector. Often used with 4 and 8 twisted pair cabling. By using this cables pin 3-6 and 1-2 are twisted pairs.

7 Industrial connectors

7.1 5-pin “mini” style connector

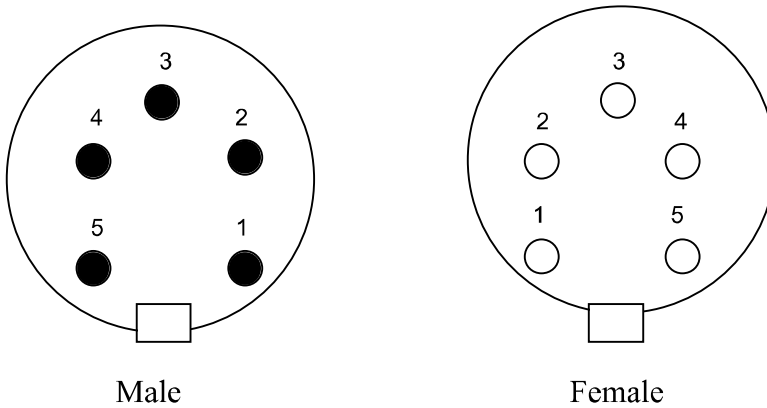

So-called 5-pin mini style connectors (ANSI/B.93.55M-1981) connector using the following pinning applies:

Pin	Signal	Description
1	(CAN_SHLD)	Optional CAN Shield
2	(CAN_V+)	Optional CAN external positive supply (dedicated for supply of transceiver and opto couplers, if galvanic isolation of the bus node applies)
3	CAN_GND	Ground / 0V / V-
4	CAN_H	CAN_H bus line (dominant high)
5	CAN_L	CAN_L bus line (dominant low)

The bus node provides the male pins of the connector. The male contacts shall meet 7/8-16 UN2A connection thread. The female contacts shall meet 7/8-16 UN2B connection thread.

7.2 5-pin “micro” style connector

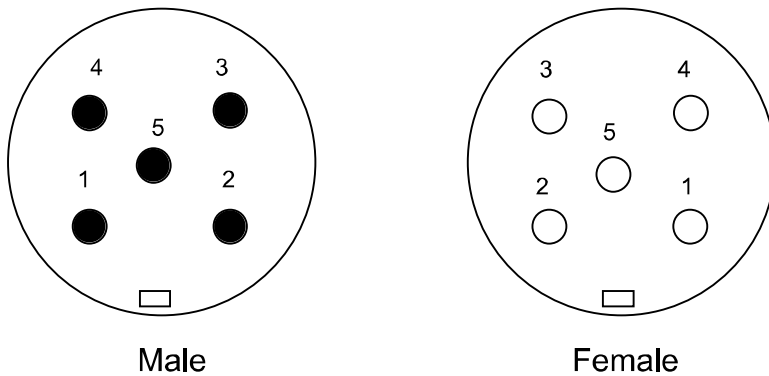

So-called 5-pin micro style connector (M12) shall use the following pinning applies:

Pin	Signal	Description
1	(CAN_SHLD)	Optional CAN Shield
2	(CAN_V+)	Optional CAN external positive supply (dedicated for supply of transceiver and optocouplers, if galvanic isolation of the bus node applies)
3	CAN_GND	Ground / 0V / V-
4	CAN_H	CAN_H bus line (dominant high)
5	CAN_L	CAN_L bus line (dominant low)

The bus node provides the male pins of the connector (IEC 60947-5-2).

7.3 Open style connector

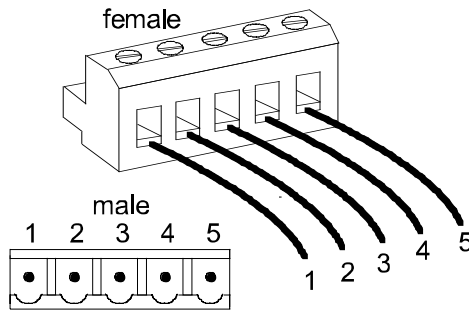

If Open Style Connectors are used the following pinning is recommended:

Pin	Signal	Description
1	CAN_GND	Ground / 0 V / V-
2	CAN_L	CAN_L bus line (dominant low)
3	(CAN_SHLD)	Optional CAN Shield
4	CAN_H	CAN_H bus line (dominant high)
5	(CAN_V+)	Optional CAN external positive supply (dedicated for supply of transceiver and opto-couplers, if galvanic isolation of the bus node applies)

4-pin Open Style Connectors either use pins 1-4 (Version A) or pins 2-5 (Version B). 3-pin Open Style Connectors use pins 2-4. The bus node provides the male pins of the connector.

8 Special purpose connectors

8.1 7-pin round connector

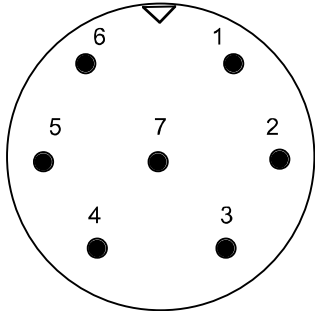

Male

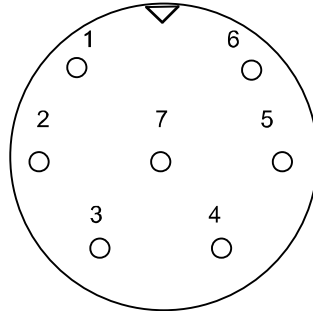

Female

Pin	Signal	Description
1	(CAN_V+)	Optional CAN external positive supply (dedicated for supply of transceiver and opto-couplers, if galvanic isolation of the bus node applies)
2	CAN_GND	Ground / 0 V / V-
3	CAN_H	CAN_H bus line (dominant high)
4	CAN_L	CAN_L bus line (dominant low)
5	DIL-1	DIP switch 1 connected with CAN_V+
6	DIL-2	DIP switch 2 connected with CAN_V+
7	DIL-3	DIP switch 3 connected with CAN_V+

The bus node provides the female pins of the connector.

8.2 8-pin round connector

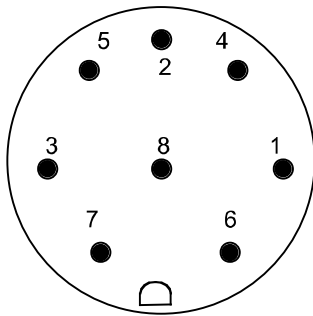

Male

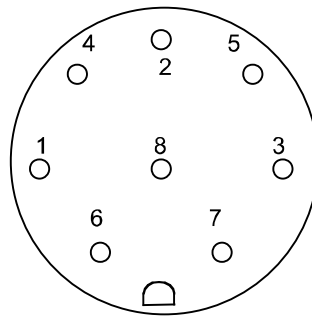

Female

Pin	Signal	Description
1	CAN_V+	24V CAN external positive supply (dedicated for supply of transceiver and opto-couplers, if galvanic isolation of the bus node applies)
2	GND	0 V
3	CAN_H	CAN_H bus line (dominant high)
4	CAN_L	CAN_L bus line (dominant low)
5	CAN_GND	Ground
6	-	Reserved
7	-	Reserved
8	-	Reserved

The bus node provides the female pins of the connector. This type corresponds with IEC 60130-9.

8.3 9-pin round connector

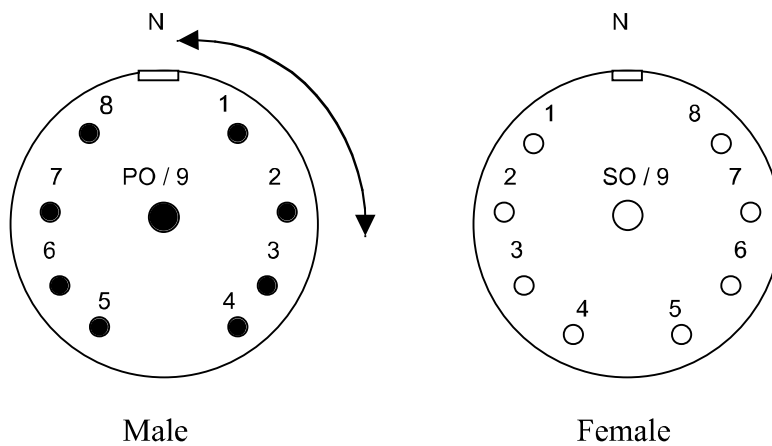

Pin	Signal	Description
1	CAN_H	CAN_H bus line (dominant high)
2	CAN_L	CAN_L bus line (dominant low)
3	CAN_GND	Ground / 0 V / V-
4	-	Reserved
5	-	Reserved
6	-	Reserved
7	(CAN_V+)	Optional CAN external positive supply (dedicated for supply of transceiver and opto-couplers, if galvanic isolation of the bus node applies)
8	(GND)	Optional Ground
9	-	Reserved

The female connector type is RC-09S1N and the male connector type is RC-09P1N manufactured from Coninvers, Herrenberg or equivalent.

8.4 12-pin round flange connector

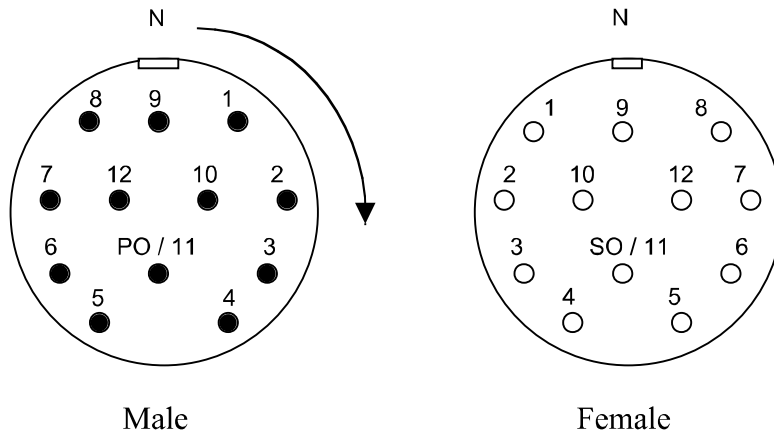

Pin	Signal	Description
1	-	Reserved
2	CAN_L	CAN_L bus line (dominant low)
3	CAN_GND	Ground / 0 V / V-
4	-	Reserved
5	-	Reserved
6	-	Reserved
7	CAN_H	CAN_H bus line (dominant high)
8		not used
9	-	Reserved
10	(GND)	Optional Ground
11	-	Reserved
12	(CAN_V+)	Optional CAN external positive supply (dedicated for supply of transceiver and opto-couplers, if galvanic isolation of the bus node applies)

The female connector type is RC12S1N121 and the male connector type is RC-12P1N121 manufactured from Coninvers, Herrenberg or equivalent.

8.5 9-pin flange round T-connector with ID-switch

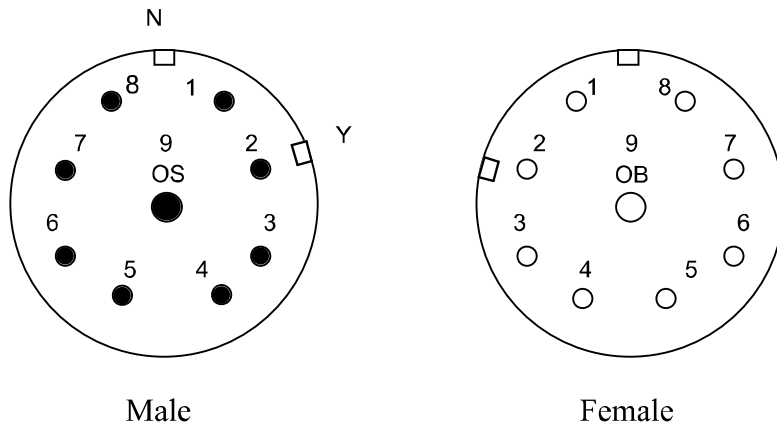

Pin	Signal	Description
1	(CAN_V+)	Optional CAN external positive supply (dedicated for supply of transceiver and opto-couplers, if galvanic isolation of the bus node applies)
2	CAN_H	CAN_H bus line (dominant high)
3	DIL-1	DIP switch 1 connected with CAN_V+
4	DIL-2	DIP switch 2 connected with CAN_V+
5	DIL-3	DIP switch 3 connected with CAN_V+
6	DIL-4	DIP switch 4 connected with CAN_V+
7	CAN_L	CAN_L bus line (dominant low)
8	CAN_GND	Ground / 0 V / V-
9	-	Reserved

These type named “Zylin series R2.5” is manufactured by LAPP Kabel / Contact Connectors. The hardware setting of up to 16 Node-ID is overwritable by normal CANopen services. This T-connector is designed for using a 4-wire bus cabling. The diameter of this T-connector is about 25 mm.