

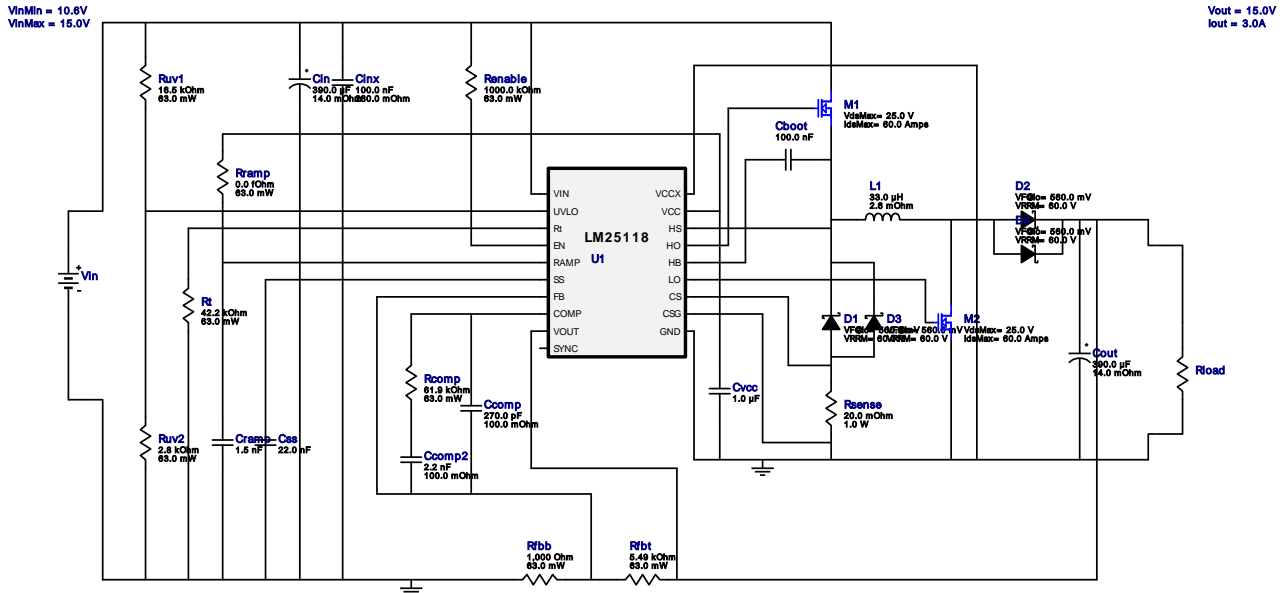

WEBENCH® Design Report

 Design : 1175773/529 LM25118MH/NOPB
 LM25118MH/NOPB 10.6V-15.0V to 15.0V @ 3.0A

Electrical BOM

#	Name	Manufacturer	Part Number	Properties	Qty	Price	Footprint
1.	Cboot	Yageo America	CC0805KRX7R9BB104 Series= X7R	Cap= 100.0 nF VDC= 50.0 V IRMS= 0.0 A	1	\$0.01	0805 7mm2
2.	Ccomp	CUSTOM	CUSTOM Series= CUSTOM	Cap= 270.0 pF ESR= 100.0 mOhm VDC= 50.0 V IRMS= 1.0 A	1	\$0.10	CUSTOM 3mm2
3.	Ccomp2	CUSTOM	CUSTOM Series= CUSTOM	Cap= 2.2 nF ESR= 100.0 mOhm VDC= 50.0 V IRMS= 1.0 A	1	\$0.10	CUSTOM 3mm2
4.	Cin	Panasonic	20SVPF390M Series= 1273	Cap= 390.0 uF ESR= 14.0 mOhm VDC= 20.0 V IRMS= 4.95 A	1	\$0.63	 CAPSMT_62_E12 106mm2
5.	Cinx	AVX	08053C104KAT2A Series= X7R	Cap= 100.0 nF ESR= 280.0 mOhm VDC= 25.0 V IRMS= 0.0 A	1	\$0.01	0805 7mm2
6.	Cout	Panasonic	20SVPF390M Series= 1273	Cap= 390.0 uF ESR= 14.0 mOhm VDC= 20.0 V IRMS= 4.95 A	1	\$0.63	 CAPSMT_62_E12 106mm2
7.	Cramp	Yageo America	CC0805KRX7R9BB152 Series= X7R	Cap= 1.5 nF VDC= 50.0 V IRMS= 0.0 A	1	\$0.01	0805 7mm2
8.	Css	Yageo America	CC0805KRX7R9BB223 Series= X7R	Cap= 22.0 nF VDC= 50.0 V IRMS= 0.0 A	1	\$0.01	0805 7mm2

#	Name	Manufacturer	Part Number	Properties	Qty	Price	Footprint
9.	Cvcc	MuRata	GRM155R61A105KE15D Series= X5R	Cap= 1.0 μ F VDC= 10.0 V IRMS= 0.0 A	1	\$0.01	 0402 3mm2
10.	D1	Diodes Inc.	PDS760-13	VF@Io= 560.0 mV VRRM= 60.0 V	1	\$0.60	 PowerDI5 50mm2
11.	D2	Diodes Inc.	PDS760-13	VF@Io= 560.0 mV VRRM= 60.0 V	1	\$0.60	 PowerDI5 50mm2
12.	D3	Diodes Inc.	PDS760-13	VF@Io= 560.0 mV VRRM= 60.0 V	1	\$0.60	 PowerDI5 50mm2
13.	D4	Diodes Inc.	PDS760-13	VF@Io= 560.0 mV VRRM= 60.0 V	1	\$0.60	 PowerDI5 50mm2
14.	L1	Coilcraft	SER2918H-333KL	L= 33.0 μ H DCR= 2.6 mOhm	1	\$2.40	 SER2918 895mm2
15.	M1	Texas Instruments	CSD16327Q3	VdsMax= 25.0 V IdsMax= 60.0 Amps	1	\$0.44	 TRANS_NexFET_Q3 19mm2
16.	M2	Texas Instruments	CSD16327Q3	VdsMax= 25.0 V IdsMax= 60.0 Amps	1	\$0.44	 TRANS_NexFET_Q3 19mm2
17.	Rcomp	CUSTOM	CUSTOM Series= CUSTOM	Res= 61.9 kOhm Power= 63.0 mW Tolerance= 1.0%	1	\$0.10	CUSTOM 1mm2
18.	Renable	Vishay-Dale	CRCW04021M00FKED Series= CRCW..e3	Res= 1000.0 kOhm Power= 63.0 mW Tolerance= 1.0%	1	\$0.01	 0402 3mm2
19.	Rfbb	Vishay-Dale	CRCW04021K00FKED Series= CRCW..e3	Res= 1,000 Ohm Power= 63.0 mW Tolerance= 1.0%	1	\$0.01	 0402 3mm2
20.	Rfbt	CUSTOM	CUSTOM Series= CUSTOM	Res= 5.49 kOhm Power= 63.0 mW Tolerance= 1.0%	1	\$0.10	CUSTOM 1mm2
21.	Rramp	CUSTOM	CUSTOM Series= CUSTOM	Res= 0.0 fOhm Power= 63.0 mW Tolerance= 1.0%	1	\$0.10	CUSTOM 1mm2
22.	Rsense	CUSTOM	CUSTOM Series= CUSTOM	Res= 20.0 mOhm Power= 1.0 W Tolerance= 1.0%	1	\$0.10	CUSTOM 20mm2
23.	Rt	Vishay-Dale	CRCW040242K2FKED Series= CRCW..e3	Res= 42.2 kOhm Power= 63.0 mW Tolerance= 1.0%	1	\$0.01	 0402 3mm2
24.	Ruv1	Vishay-Dale	CRCW040216K5FKED Series= CRCW..e3	Res= 16.5 kOhm Power= 63.0 mW Tolerance= 1.0%	1	\$0.01	 0402 3mm2
25.	Ruv2	Vishay-Dale	CRCW04022K80FKED Series= CRCW..e3	Res= 2.8 kOhm Power= 63.0 mW Tolerance= 1.0%	1	\$0.01	 0402 3mm2

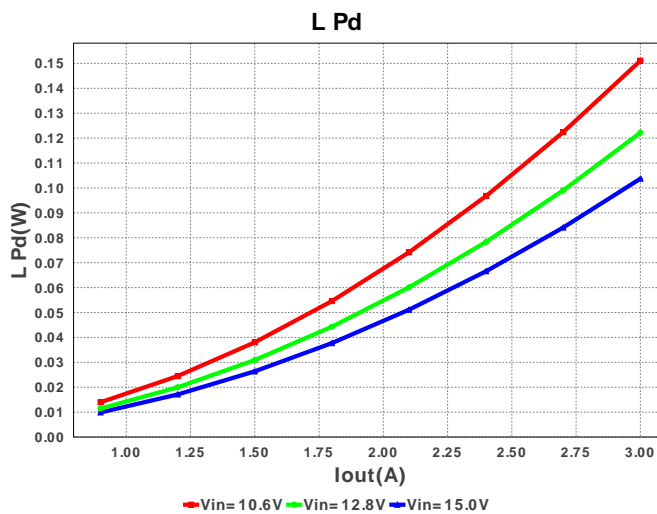
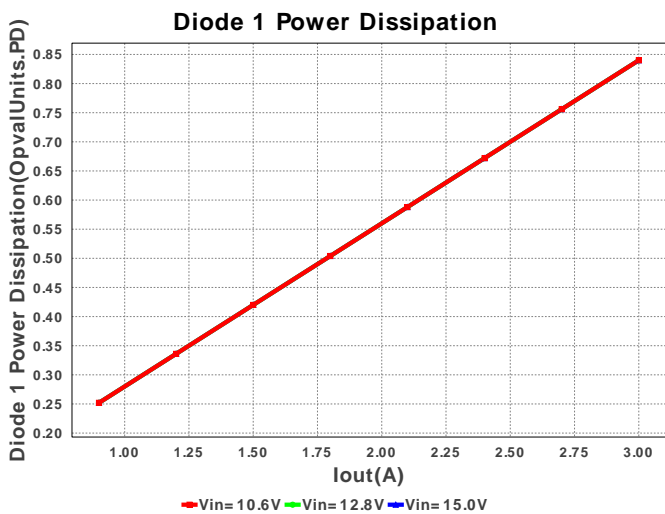
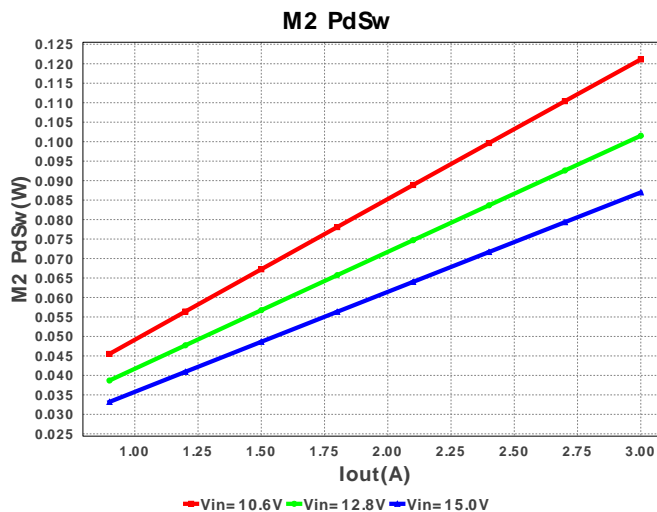
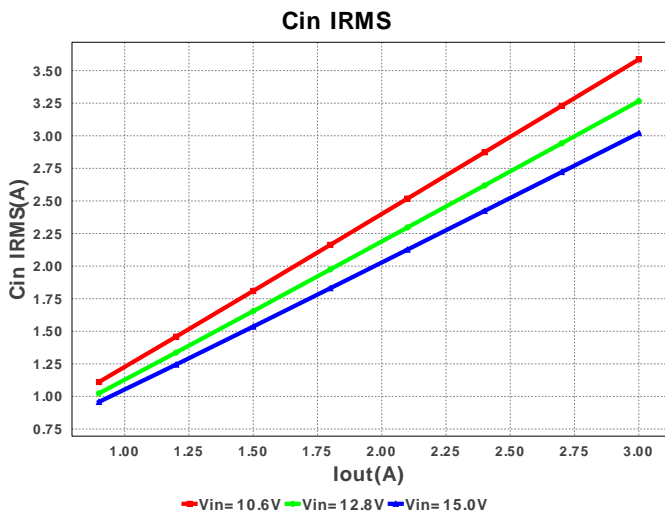
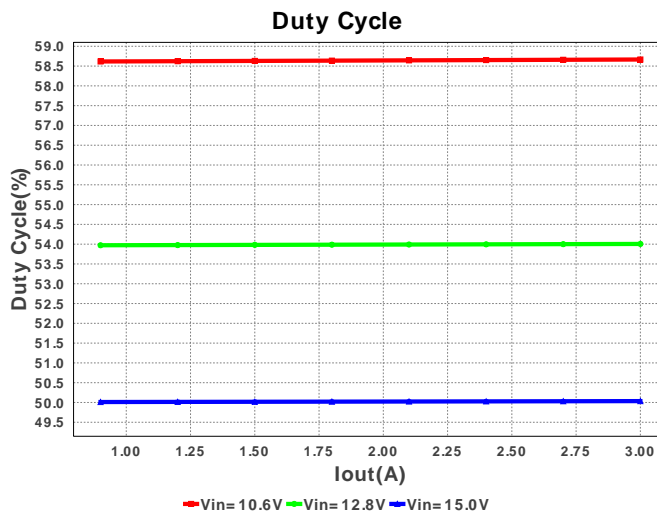
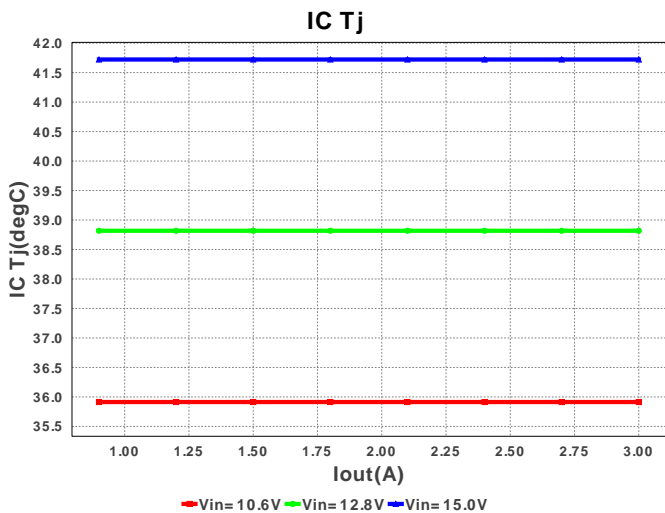
#	Name	Manufacturer	Part Number	Properties	Qty	Price	Footprint
26.	U1	Texas Instruments	LM25118MH/NOPB	Switcher	1	\$2.40	 MXA20A 71mm2

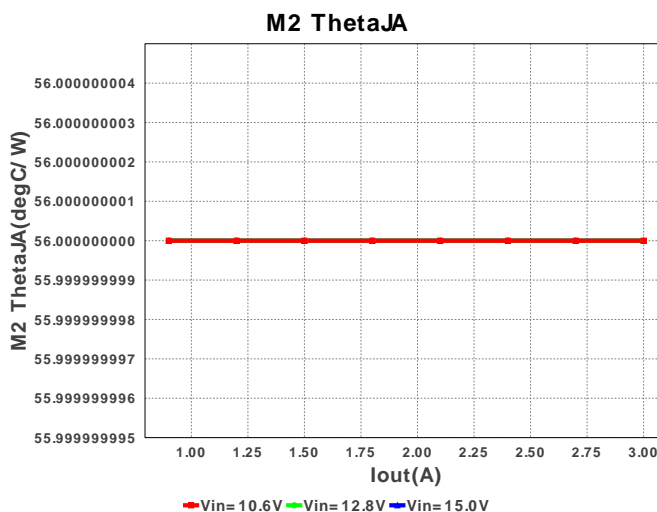
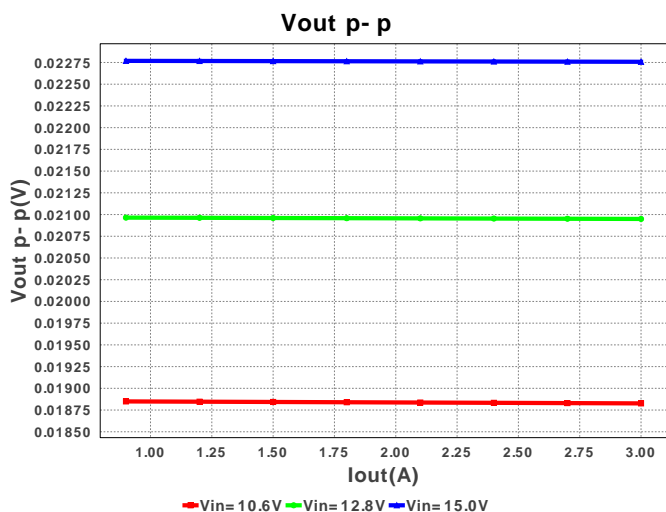
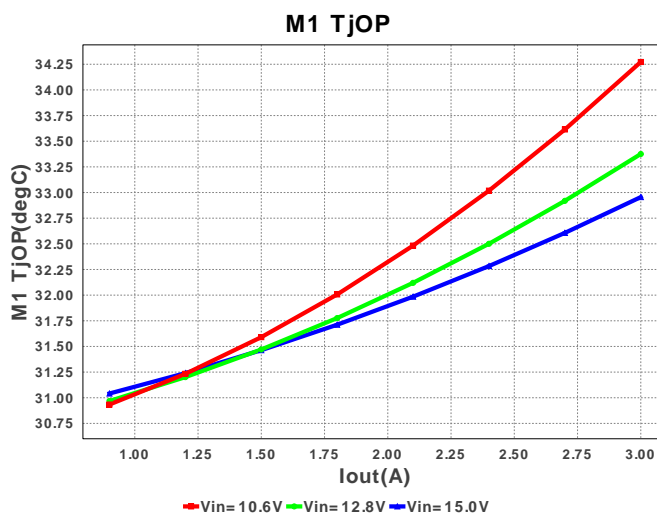
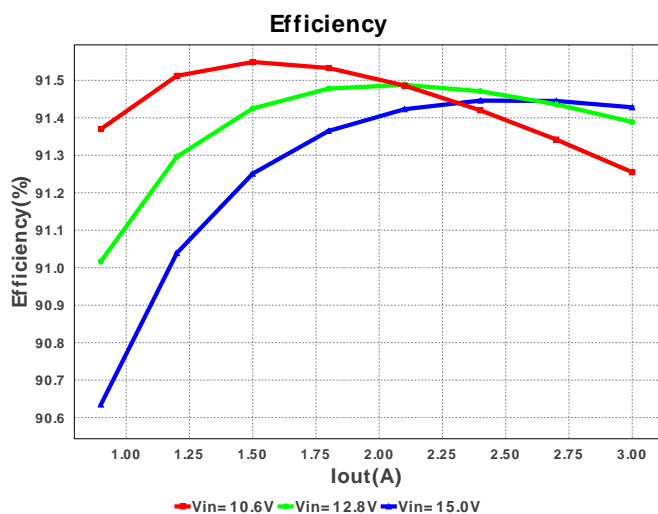
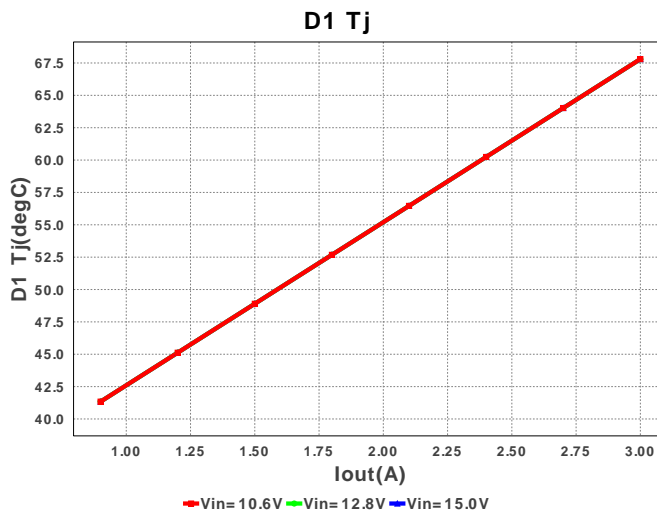
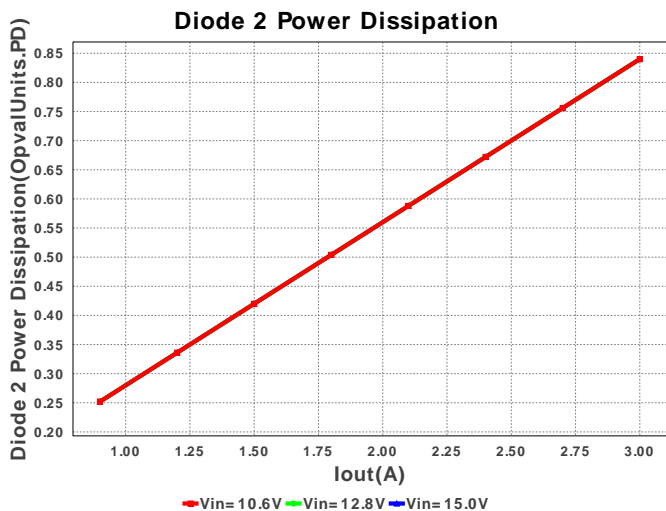



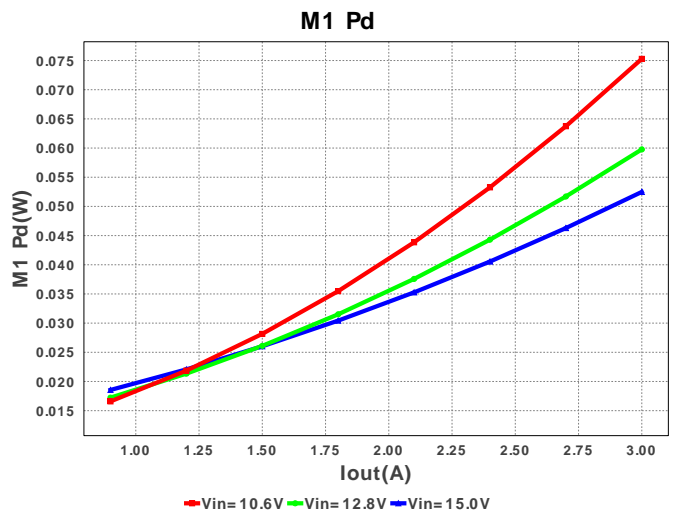
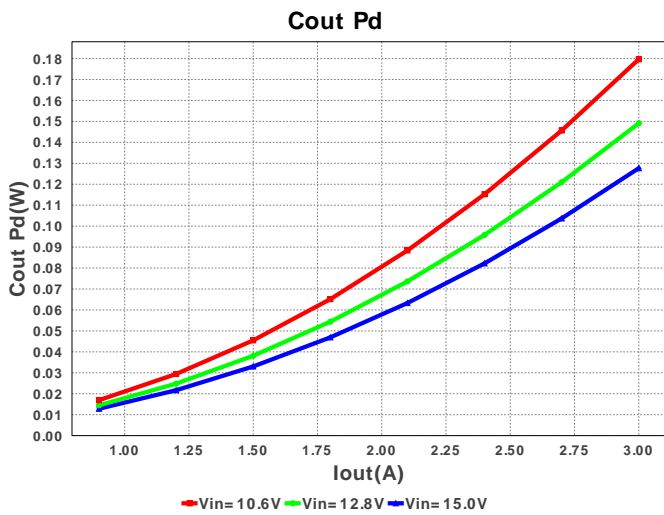
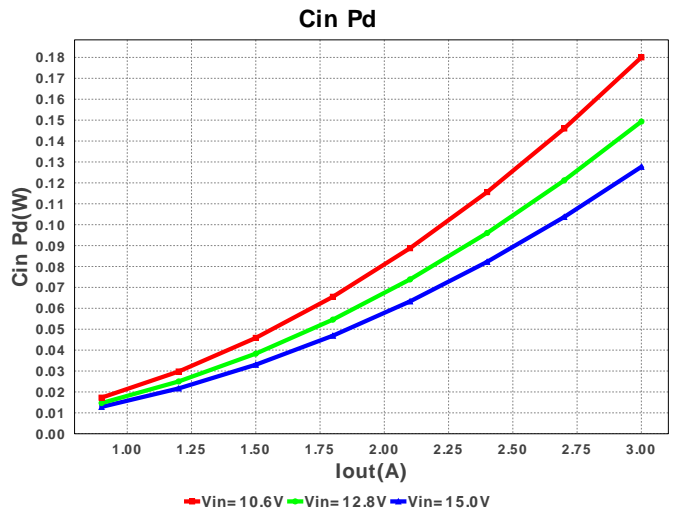
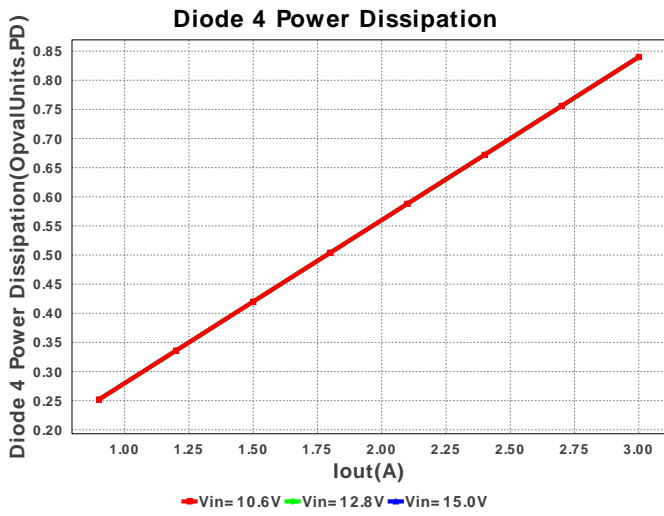
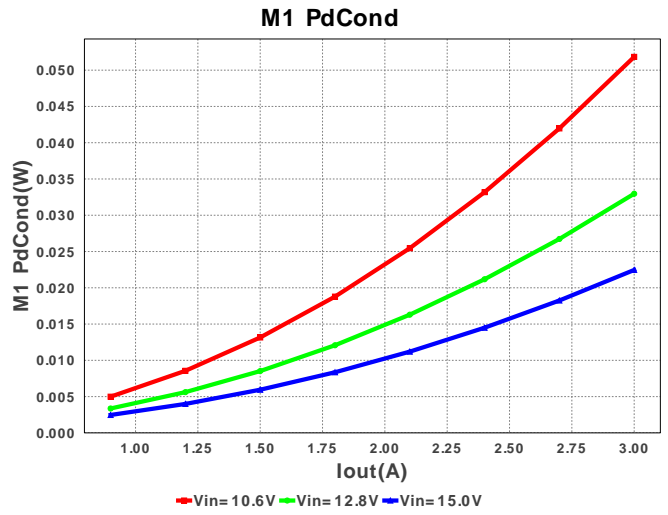
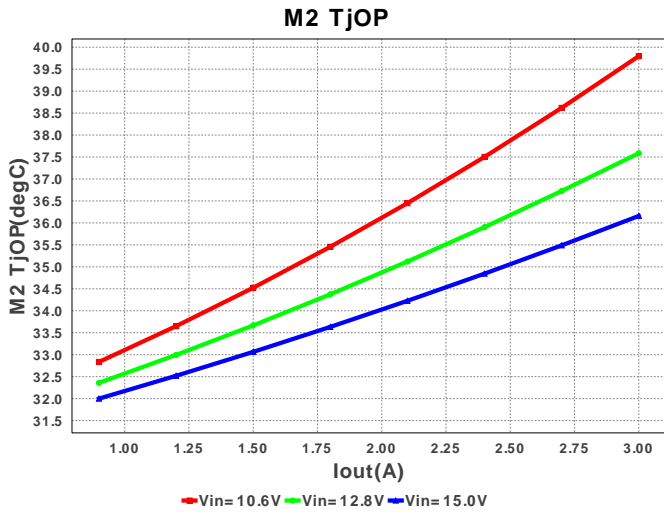

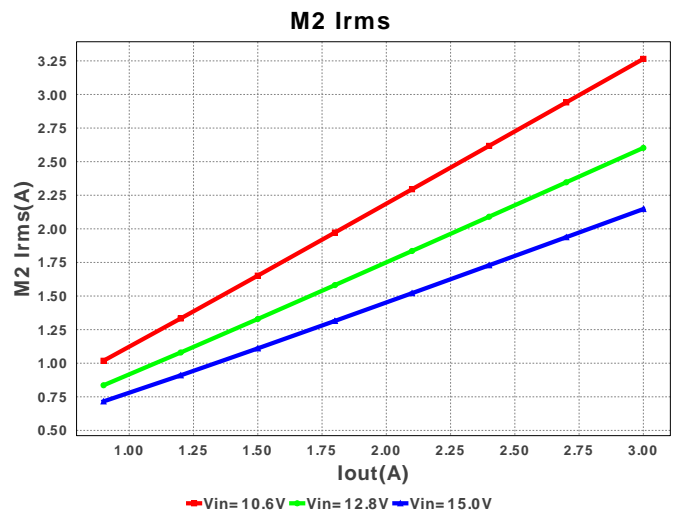
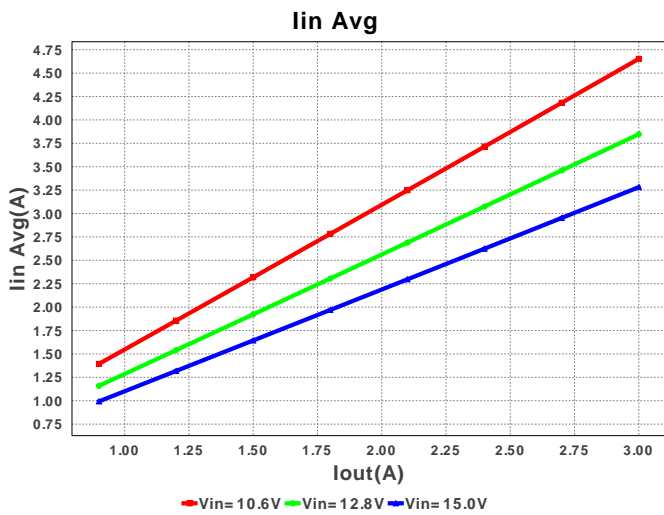
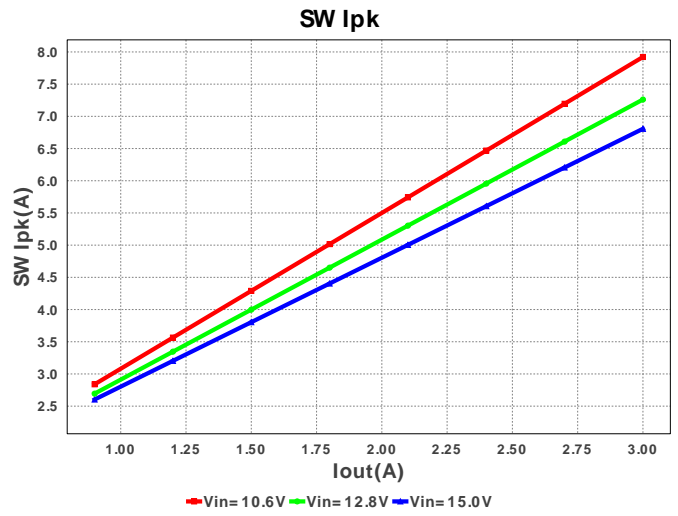
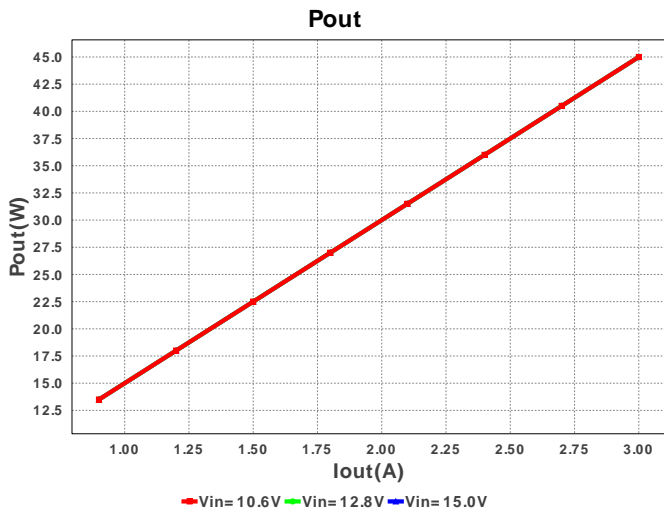
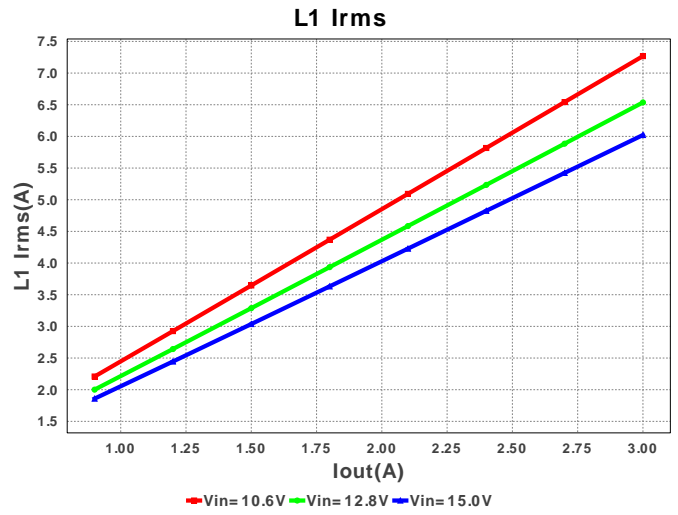
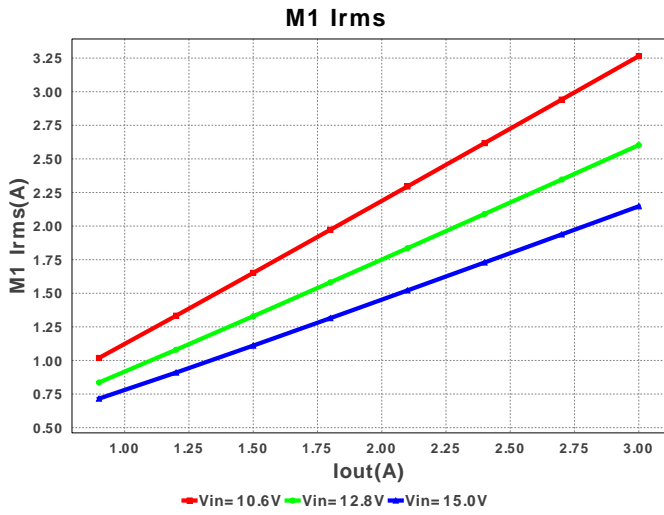

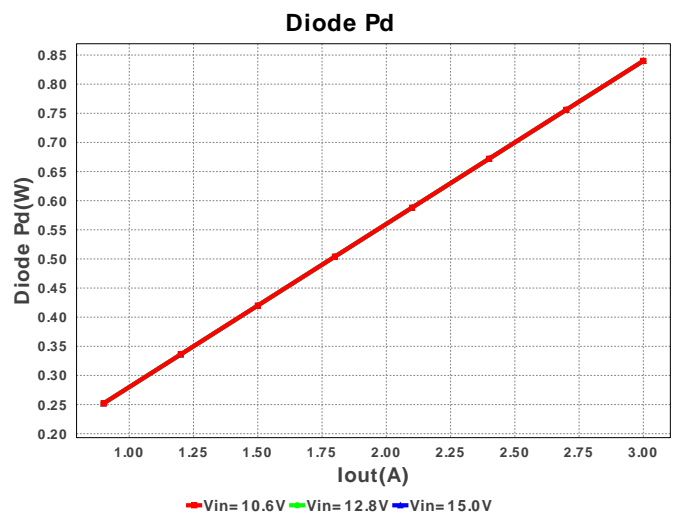
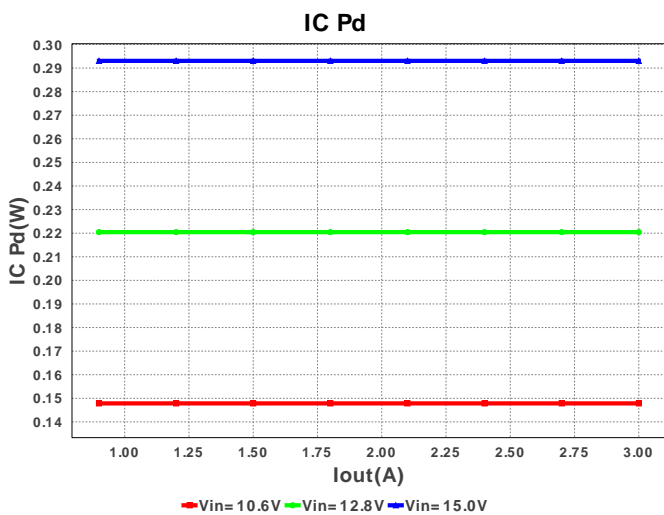
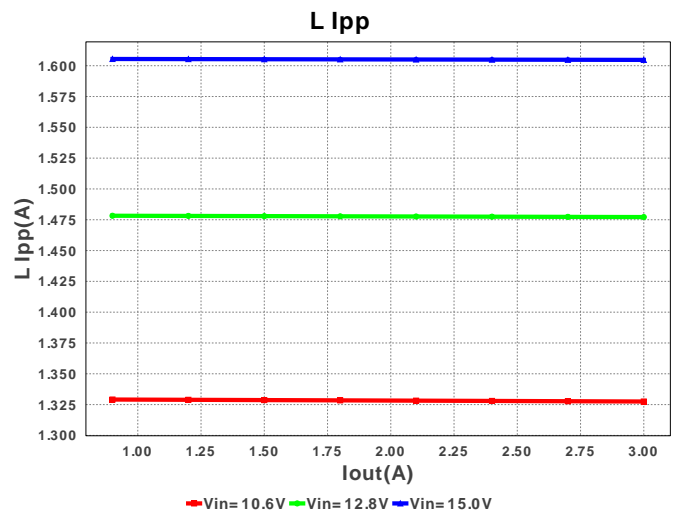
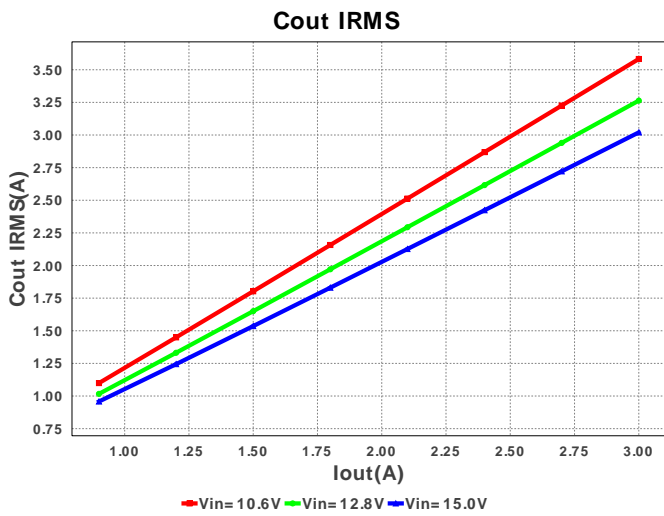
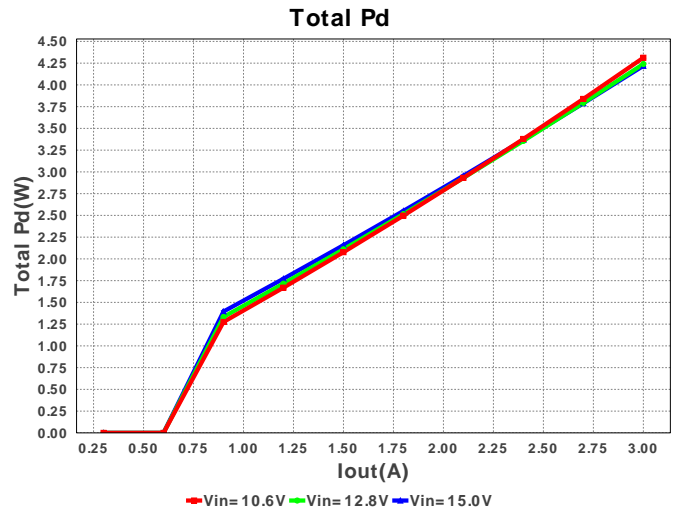
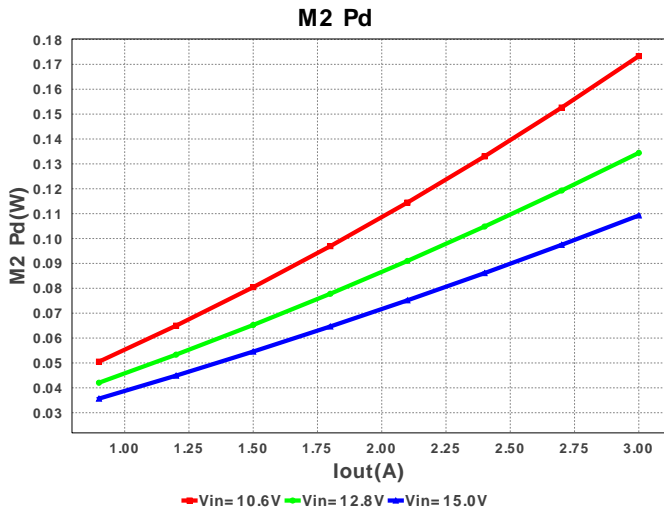

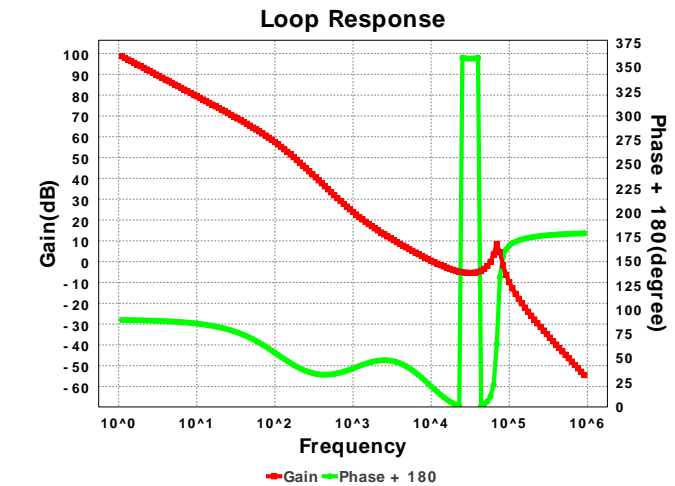
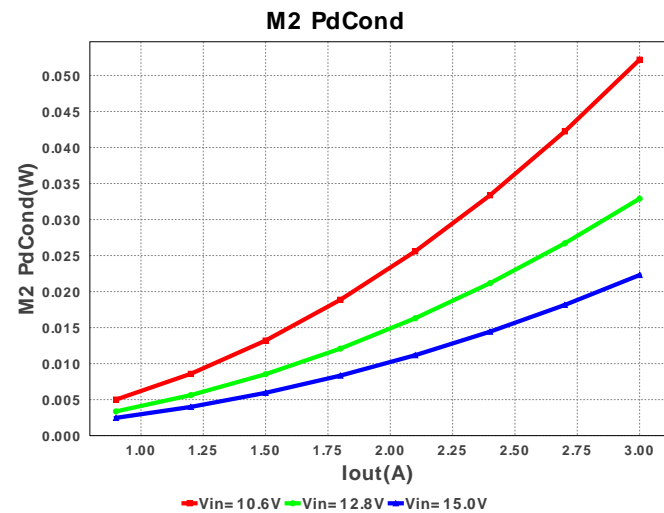
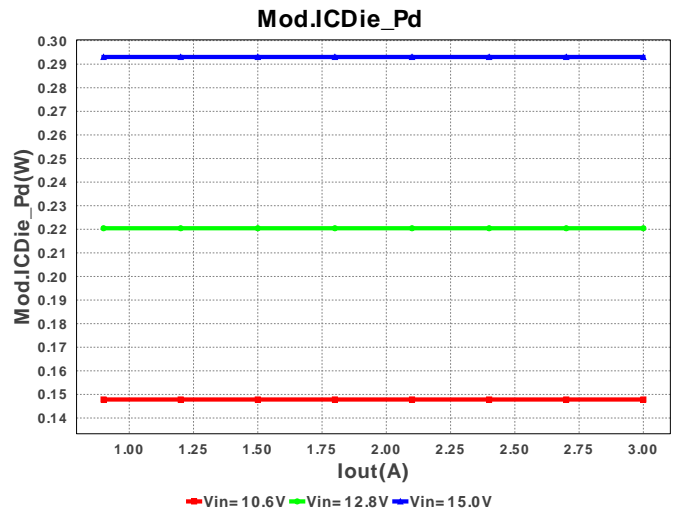
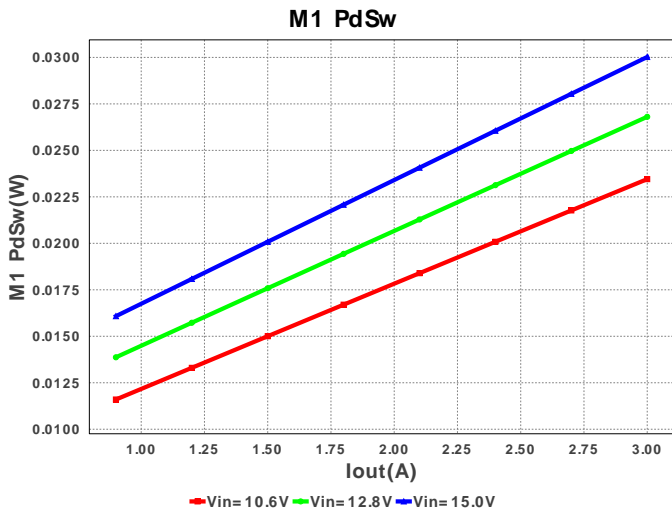
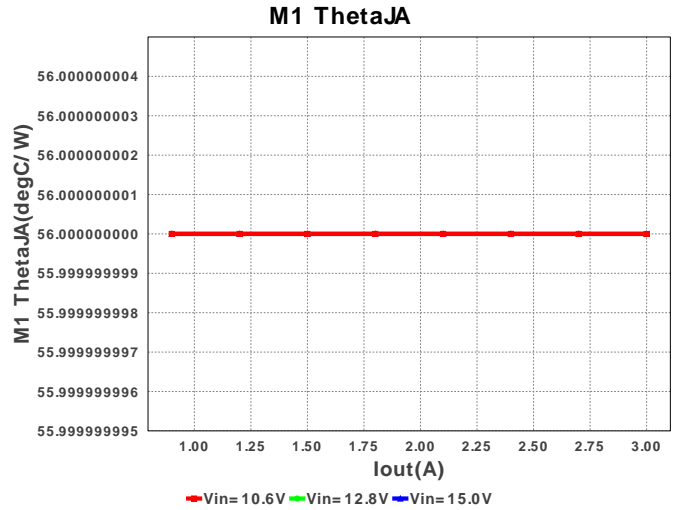
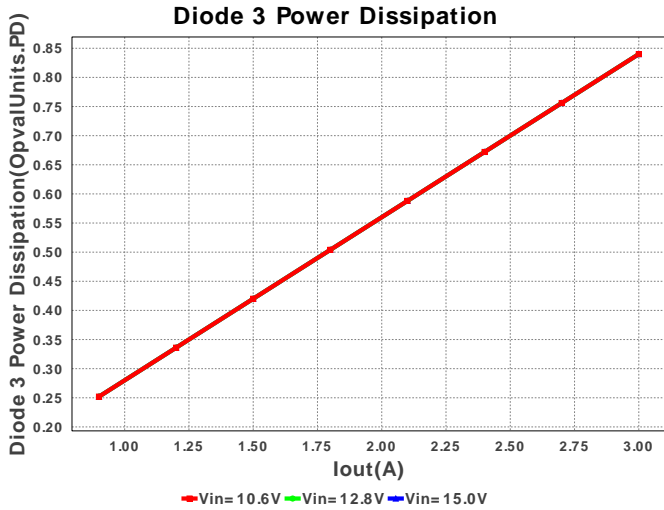

Operating Values

#	Name	Value	Category	Description
1.	Total BOM	\$10.04		Total BOM Cost
2.	Cin IRMS	3.586 A	Current	Input capacitor RMS ripple current
3.	Cout IRMS	3.583 A	Current	Output capacitor RMS ripple current
4.	Iin Avg	3.297 A	Current	Average input current
5.	L Ipp	1.327 A	Current	Peak-to-peak inductor ripple current
6.	L1 Irms	7.268 A	Current	Inductor ripple current
7.	M1 Irms	3.265 A	Current	MOSFET RMS ripple current
8.	M2 Irms	3.265 A	Current	MOSFET RMS ripple current
9.	SW Ipk	7.922 A	Current	Peak switch current
10.	BOM Count	2	General	Total Design BOM count
11.	FootPrint	1.552 kmm2	General	Total Foot Print Area of BOM components

#	Name	Value	Category	Description
12.	Frequency	141.53 kHz	General	Switching frequency
13.	IC Tolerance	18.0 mV	General	IC Feedback Tolerance
14.	M1 ThetaJA	56.0 degC/W	General	MOSFET junction-to-ambient thermal resistance
15.	M2 ThetaJA	56.0 degC/W	General	MOSFET junction-to-ambient thermal resistance
16.	Pout	45.0 W	General	Total output power
17.	D1 Tj	67.8 degC	Op_Point	D1 junction temperature
18.	Vout OP	15.0 V	Op_Point	Operational Output Voltage
19.	Cross Freq	12.764 kHz	Op_point	Bode plot crossover frequency
20.	Duty Cycle	58.666 %	Op_point	Duty cycle
21.	Efficiency	90.987 %	Op_point	Steady state efficiency
22.	IC Tj	41.722 degC	Op_point	IC junction temperature
23.	ICThetaJA	40.0 degC/W	Op_point	IC junction-to-ambient thermal resistance
24.	IOUT_OP	3.0 A	Op_point	Iout operating point
25.	M1 TjOP	34.272 degC	Op_point	MOSFET junction temperature
26.	M2 TjOP	39.797 degC	Op_point	MOSFET junction temperature
27.	Phase Marg	-277.259 mdeg	Op_point	Bode Plot Phase Margin
28.	VIN_OP	10.6 V	Op_point	Vin operating point
29.	Vout p-p	18.827 mV	Op_point	Peak-to-peak output ripple voltage
30.	Cin Pd	180.041 mW	Power	Input capacitor power dissipation
31.	Cout Pd	179.684 mW	Power	Output capacitor power dissipation
32.	Diode Pd	840.0 mW	Power	Diode power dissipation
33.	IC Pd	293.044 mW	Power	IC power dissipation
34.	L Pd	151.079 mW	Power	Inductor power dissipation
35.	M1 Pd	75.375 mW	Power	MOSFET power dissipation
36.	M1 PdCond	51.923 mW	Power	M1 MOSFET conduction losses
37.	M1 PdSw	23.452 mW	Power	M1 MOSFET switching losses
38.	M2 Pd	173.315 mW	Power	MOSFET power dissipation
39.	M2 PdCond	52.194 mW	Power	M2 MOSFET conduction losses
40.	M2 PdSw	121.121 mW	Power	M2 MOSFET switching losses
41.	Total Pd	3.15 W	Power	Total Power Dissipation
42.	Diode 1 Power Dissipation	840.0 mOpvalUnits.PD	Unknown	Power dissipation in the diode
43.	Diode 2 Power Dissipation	840.0 mOpvalUnits.PD	Unknown	Power dissipation in the diode
44.	Diode 3 Power Dissipation	840.0 mOpvalUnits.PD	Unknown	Power dissipation in the diode
45.	Diode 4 Power Dissipation	840.0 mOpvalUnits.PD	Unknown	Power dissipation in the diode

Design Inputs

#	Name	Value	Description
1.	Iout	3.0 A	Maximum Output Current
2.	Iout1	3.0 Amps	Output Current #1
3.	VinMax	15.0 V	Maximum input voltage
4.	VinMin	10.6 V	Minimum input voltage
5.	Vout	15.0 V	Output Voltage
6.	Vout1	15.0 Volt	Output Voltage #1
7.	base_pn	LM25118	Base Product Number
8.	source	DC	Input Source Type
9.	Ta	30.0 degC	Ambient temperature
10.	UserFsw	141.667 kHz	Customer Selected Frequency

Design Assistance

1. The LM5118 is a wide range buck-boost controller which is operable in an ultra wide input range of 3 to 75V. A buck-boost regulator can maintain regulation for input voltages either higher or lower than the output voltage. The challenge is that buck-boost power converters are not as efficient as buck regulators. The LM5118 has been designed as a dual mode controller whereby the power converter acts as a buck regulator while the input voltage is above the output. As the input voltage approaches the output voltage, a gradual transition to the buck-boost mode occurs. This gradual transition between modes eliminates disturbances at the output during transitions.

2. **LM25118** Product Folder : <http://www.ti.com/product/lm25118> : contains the data sheet and other resources.

Texas Instruments' WEBENCH simulation tools attempt to recreate the performance of a substantially equivalent physical implementation of the design. Simulations are created using Texas Instruments' published specifications as well as the published specifications of other device manufacturers. While Texas Instruments does update this information periodically, this information may not be current at the time the simulation is built. Texas Instruments does not warrant the accuracy or completeness of the specifications or any information contained therein. Texas Instruments does not warrant that any designs or recommended parts will meet the specifications you entered, will be suitable for your application or fit for any particular purpose, or will operate as shown in the simulation in a physical implementation. Texas Instruments does not warrant that the designs are production worthy.

You should completely validate and test your design implementation to confirm the system functionality for your application prior to production.

Use of Texas Instruments' WEBENCH simulation tools is subject to [Texas Instruments' Site Terms and Conditions of Use](#). Prototype boards based on WEBENCH created designs are provided AS IS without warranty of any kind for evaluation and testing purposes and are subject to the terms of the [Evaluation License Agreement](#).