

LMK048xx Evaluation Board

User's Guide



August 2011

SNAU076B
Revised August 2014



Low-Noise Clock Jitter Cleaner with Dual Loop PLLs Evaluation Board Operating Instructions

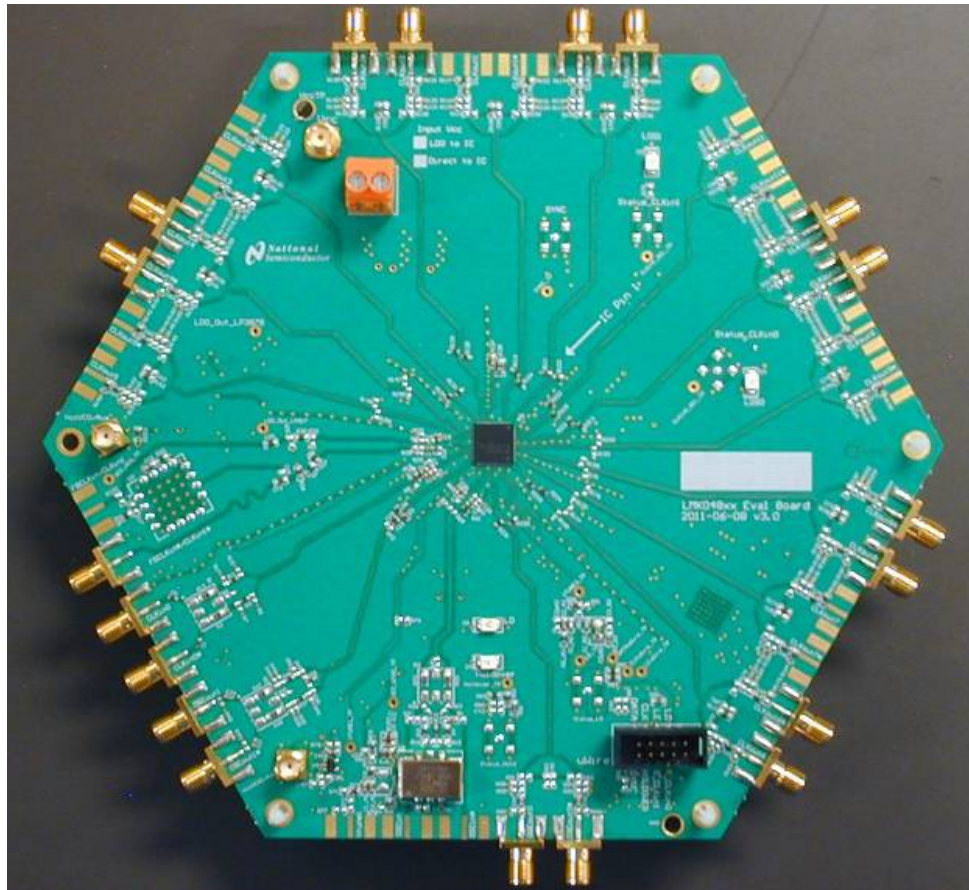

Table of Contents

TABLE OF CONTENTS	3
GENERAL DESCRIPTION	5
EVALUATION BOARD KIT CONTENTS	5
AVAILABLE LMK048XX EVALUATION BOARDS	5
AVAILABLE LMK04800 FAMILY DEVICES	5
QUICK START	6
DEFAULT CODELOADER MODES FOR EVALUATION BOARDS	7
EXAMPLE: USING CODELOADER TO PROGRAM THE LMK04808B	8
1. START CODELOADER 4 APPLICATION	8
2. SELECT DEVICE	8
3. PROGRAM/LOAD DEVICE	8
4. RESTORING A DEFAULT MODE	9
5. VISUAL CONFIRMATION OF FREQUENCY LOCK	10
6. ENABLE CLOCK OUTPUTS	10
PLL LOOP FILTERS AND LOOP PARAMETERS	12
PLL 1 LOOP FILTER	12
122.88 MHz VCXO PLL	12
PLL2 LOOP FILTER	13
Integrated VCO PLL	13
EVALUATION BOARD INPUTS AND OUTPUTS	14
RECOMMENDED TEST EQUIPMENT	22
PROGRAMMING 0-DELAY MODE IN CODELOADER	23
OVERVIEW	23
DUAL LOOP 0-DELAY MODE EXAMPLES	23
Programming Steps	23
Details	23
SINGLE LOOP 0-DELAY MODE EXAMPLES	25
Programming Steps	25
Details	25
APPENDIX A: CODELOADER USAGE	27
PORT SETUP TAB	27
CLOCK OUTPUTS TAB	28
PLL1 TAB	30
Setting the PLL1 VCO Frequency and PLL2 Reference Frequency	31
PLL2 TAB	32
BITS/PINS TAB	33
REGISTERS TAB	38
APPENDIX B: TYPICAL PHASE NOISE PERFORMANCE PLOTS	39
PLL1	39
122.88 MHz VCXO Phase Noise	39
Clock Output Measurement Technique	40
Buffered OSCout Phase Noise	40

CLOCK OUTPUTS (CLKOUT)	41
<i>LMK04808B CLKout Phase Noise</i>	41
<i>LMK04808B OSCout Phase Noise</i>	43
<i>LMK04806B CLKout Phase Noise</i>	44
<i>LMK04806B OSCout Phase Noise</i>	46
<i>LMK04803B CLKout Phase Noise</i>	47
<i>LMK04803B OSCout Phase Noise</i>	49
APPENDIX C: SCHEMATICS	50
POWER SUPPLIES	50
LMK048xxB DEVICE WITH LOOP FILTER AND CRYSTAL CIRCUITS	51
REFERENCE INPUTS (CLKIN0 & CLKIN1), EXTERNAL VCXO (OSCIN) & VCO CIRCUITS, AND OSCOUT1 OUTPUT	52
CLOCK OUTPUTS (OSCOUT0, CLKOUT0 TO CLKOUT3)	53
CLOCK OUTPUTS (CLKOUT4 TO CLKOUT7)	54
CLOCK OUTPUTS (CLKOUT8 TO CLKOUT11)	55
UWIRE HEADER, LOGIC I/O PORTS AND STATUS LEDs	56
USB INTERFACE	57
APPENDIX D: BILL OF MATERIALS	58
APPENDIX E: PCB LAYERS STACKUP	68
APPENDIX F: PCB LAYOUT	69
LAYER #1 – TOP	69
LAYER #2 – RF GROUND PLANE (INVERTED)	70
LAYER #3 – VCC PLANES	71
LAYER #4 – GROUND PLANE (INVERTED)	72
LAYER #5 – VCC PLANES 2	73
LAYER #6 – BOTTOM	74
LAYERS #1 AND 6 – TOP AND BOTTOM (COMPOSITE)	75
APPENDIX G: EVM SOFTWARE AND COMMUNICATION: INTERFACING UWIRE	76
APPENDIX H: TROUBLESHOOTING INFORMATION	78
1) CONFIRM COMMUNICATIONS	78
2) CONFIRM PLL1 OPERATION/LOCKING	78
3) CONFIRM PLL2 OPERATION/LOCKING	79

General Description

The LMK048xx Evaluation Board simplifies evaluation of the LMK048xxB Low-Noise Clock Jitter Cleaner with Dual Loop PLLs. Texas Instruments Incorporated’s *CodeLoader* software can be used to program the internal registers of the LMK048xxB device through the USB2ANY-uWire interface. The *CodeLoader* software will run on a Windows 7 or Windows XP PC and can be downloaded from <http://www.ti.com/tool/codeloader/>.

Evaluation Board Kit Contents

The evaluation board kit includes:

- (1) LMK048xx Evaluation Board from Table 1
- (1) LMK04800 Family Quick Start Guide
 - Evaluation board instructions can be downloaded from www.ti.com.
- (1) LPT Cable or USB2ANY-uWire (HPA665-001) + adapter (Please see “EVM Software and Communication” for more information)

Available LMK048xx Evaluation Boards

The LMK048xx Evaluation Board supports any of the four devices offered in the LMK04800 Family. All evaluation boards use the same PCB layout and bill-of-materials, except for the corresponding LMK0480xxB device affixed to the board. A commercial-quality VCXO is also mounted to the board to provide a known reference point for evaluating device performance and functionality.

Table 1: Available Evaluation Board Configurations

Evaluation Board ID	Device	PLL1 VCXO
LMK04803BEVAL	LMK04803B	122.88 MHz Crystek VCXO Model CVHD-950-122.880
LMK04805BEVAL	LMK04805B	
LMK04806BEVAL	LMK04806B	
LMK04808BEVAL	LMK04808B	

Available LMK04800 Family Devices

Table 2: LMK048xxB Devices

Device	Reference Inputs	Buffered/ Divided OSCin Outputs	Programmable LVDS/LVPECL/ LVC MOS Outputs	VCO Frequency
LMK04803B	2	2	12	1840 to 2030 MHz
LMK04805B				2148 to 2370 MHz
LMK04806B				2370 to 2600 MHz
LMK04808B				2750 to 3072 MHz

Quick Start

Full evaluation board instructions are downloadable from the LMK048xxB device product folder at www.ti.com.

1. Connect a power supply voltage of **5 V** to the Vcc SMA connector. The onboard LP3878-ADJ LDO regulator will output a low-noise 3.3 V supply to operate the device.
2. Connect a reference clock from a signal source to the CLKin1 SMA port. Use **122.88 MHz** for default. The reference frequency depends on the device programming.
3. Please see Appendix G for quick start on interfacing the board
4. Program the device with a default mode using CodeLoader. Ctrl+L must be pressed at least once to load all registers. Alternatively click menu “Keyboard Controls” → “Load Device”. CodeLoader can be downloaded from <http://www.ti.com/tool/codeloader>.
5. Measurements may be made on an active output clock port via its SMA connector.

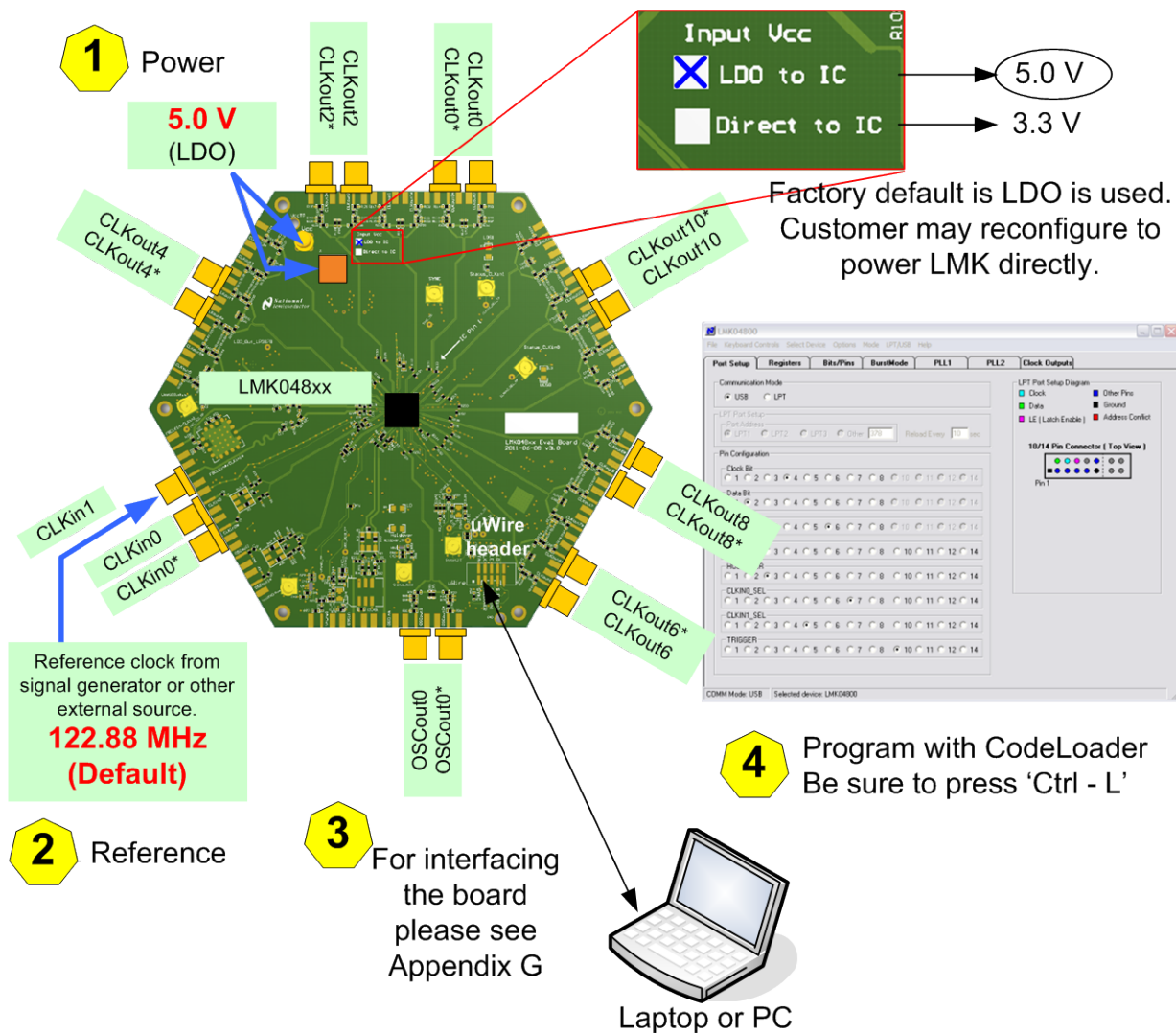

1: Quick Start Diagram

Figure

Default CodeLoader Modes for Evaluation Boards

CodeLoader saves the state of the selected LMK048xxB device when exiting the software. To ensure a common starting point, the following modes listed in Table 3 may be restored by clicking “Mode” and selecting the appropriate device configuration, as shown in Figure 2 in the case of the LMK04808B device. Similar default modes are available for each LMK048xxB device in CodeLoader. Choose a mode with CLKin0 for differential clock signal or CLKin1 for a single ended signal.

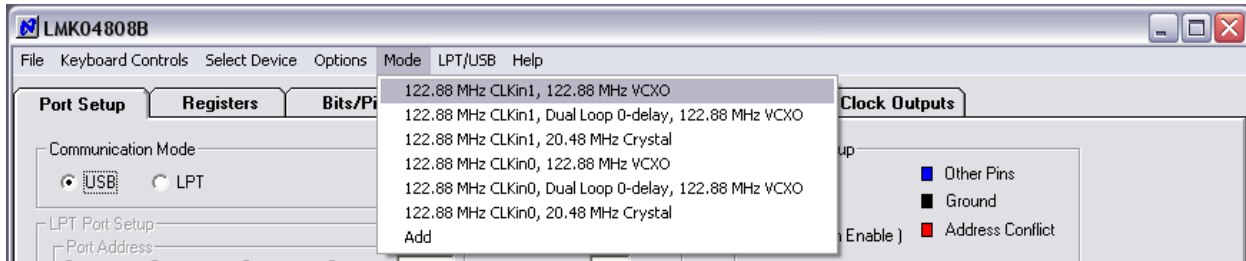

Figure 2: Selecting a Default Mode for the LMK04808 Device

After restoring a default mode, press Ctrl+L to program the device. The default modes also disable certain outputs, so make sure to enable the output under test to make measurements.

Table 3: Default CodeLoader Modes for LMK04808

Default CodeLoader Mode	Device Mode	CLKin Frequency	OSCin Frequency
122.88 MHz CLKin1, 122.88 MHz VCXO	Dual PLL, Internal VCO	122.88 MHz	122.88 MHz
122.88 MHz CLKin1, Dual Loop 0-delay, 122.88 MHz VCXO	Dual PLL, Internal VCO, 0-Delay with Internal Feedback	122.88 MHz	122.88 MHz
122.88 MHz CLKin1, 122.88 MHz VCXO	Dual PLL, Internal VCO, PLL2 Crystal Oscillator Enabled	122.88 MHz	20.48 MHz
122.88 MHz CLKin1, 122.88 MHz VCXO	Dual PLL, Internal VCO	122.88 MHz	122.88 MHz
122.88 MHz CLKin1, Dual Loop 0-delay, 122.88 MHz VCXO	Dual PLL, Internal VCO, 0-Delay with Internal Feedback	122.88 MHz	122.88 MHz
122.88 MHz CLKin1, 122.88 MHz VCXO	Dual PLL, Internal VCO, PLL2 Crystal Oscillator Enabled	122.88 MHz	20.48 MHz

The next section outlines step-by-step procedures for using the evaluation board with the LMK04808B. For boards with another part number, make sure to select the corresponding part number under the “Device” menu.

Example: Using CodeLoader to Program the LMK04808B

The purpose of this section is to walk the user through using CodeLoader 4 to make some measurements with the LMK04808B device as an example. For more information on CodeLoader refer to Appendix A: CodeLoader Usage or the CodeLoader 4 instructions located at <http://www.ti.com/tool/codeloader>.

Before proceeding, be sure to follow the Quick Start section above to ensure proper connections.

1. Start CodeLoader 4 Application

Click “Start” → “Programs” → “CodeLoader 4” → “CodeLoader 4”

The CodeLoader 4 program is installed by default to the CodeLoader 4 application group.

2. Select Device

Click “Select Device” → “Clock Conditioners” → “LMK04808B”

Once started CodeLoader 4 will load the last used device. To load a new device click “Select Device” from the menu bar, then select the subgroup and finally device to load. For this example, the LMK04808B is chosen. Selecting the device does not cause the device to be programmed.

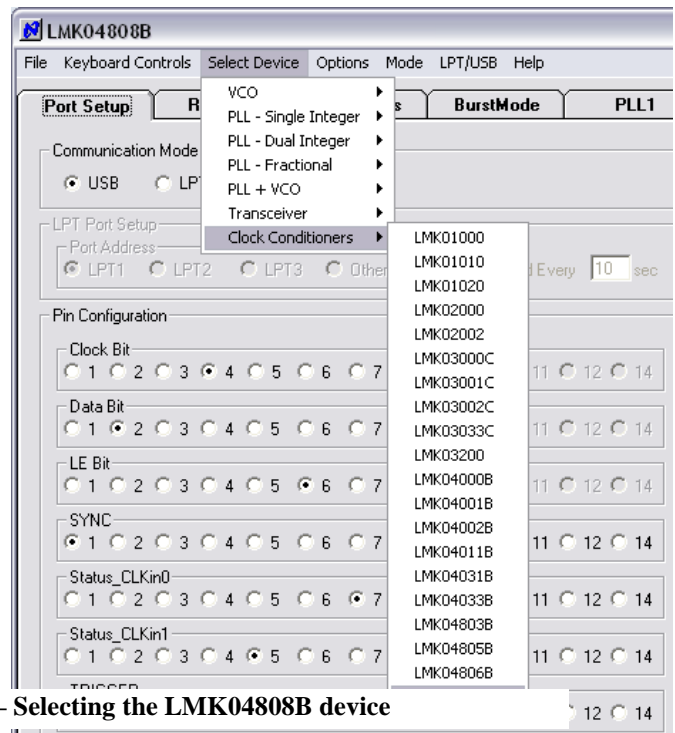

Figure 3 – Selecting the LMK04808B device

3. Program/Load Device

Assuming the Port Setup settings are correct, press the “Ctrl+L” shortcut or click “Keyboard Controls” → “Load Device” from the menu to program the device to the current state of the newly loaded LMK04800 file.

Once the device has been initially loaded, CodeLoader automatically program changed registers so it is not necessary to re-load the device upon subsequent changes in the device configuration. It is possible to disable this functionality by ensuring there is no checkmark by the “Options” → “AutoReload with Changes.”

Because a default mode will be restored in the next step, this step isn’t really needed but included to emphasize the importance of pressing “Ctrl+L” to load the device at least once after starting CodeLoader, restoring a mode, or restoring a saved setup using the File menu.

See Appendix A: CodeLoader Usage or the CodeLoader 4 instructions located at <http://www.ti.com/tool/codeloader> for more information on Port Setup. Appendix H: Troubleshooting Information contains information on troubleshooting communications.

4. Restoring a Default Mode

Click “Mode” → “LMK04808B, 122.88 MHz VCXO, 122.88 MHz CLKin1”; then press Ctrl+L.

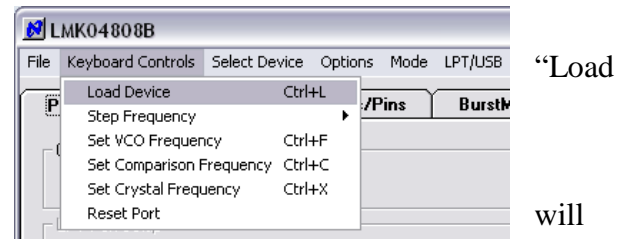

Figure 4 – Loading the Device

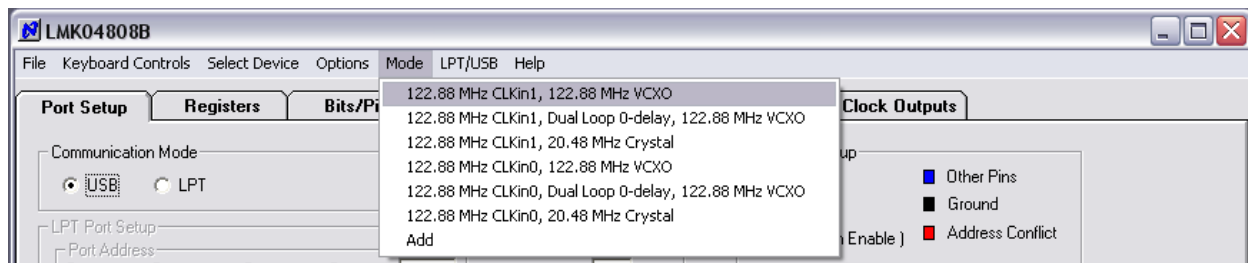

Figure 5: Setting the Default mode for LMK04808

For the purpose of this walkthrough, a default mode will be loaded to ensure a common starting point. This is important because when CodeLoader is closed, it remembers the last settings used for a particular device. Again, remember to press Ctrl+L as the first step after loading a default mode.

5. Visual Confirmation of Frequency Lock

After a default mode is restored and loaded, LED D5 should illuminate when PLL1 and PLL2 are locked to the reference clock applied to CLKin1. This assumes LD_MUX = PLL1/2 DLD and LD_TYPE = Active High, which are the default settings.

6. Enable Clock Outputs

While the LMK048xxB offers programmable clock output buffer formats, the evaluation board is shipped with preconfigured output terminations to match the default buffer type for each output. Refer to the CLKout port description in the Evaluation Board Inputs and Outputs section.

To measure phase noise at one of the clock outputs, for example, CLKout0:

1. Click on the **Clock Outputs** tab,
2. Uncheck “Powerdown” in the Digital Delay box to enable the channel,
3. Set the following settings as needed:
 - a. Digital Delay value
 - b. Clock Divider value
 - c. Analog Delay select and Analog Delay value (if not “Bypassed”)
 - d. Clock Output type.

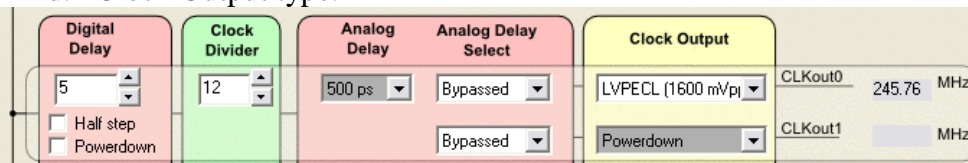

Figure 6: Setting Digital Delay, Clock Divider, Analog Delay, and Output Format for CLKout0

4. Depending on the configured output type, the clock output SMAs can be interfaced to a test instrument with a single-ended 50-ohm input as follows.
 - a. For LVDS:
 - i. A balun (like ADT2-1T) is recommended for differential-to-single-ended conversion.
 - b. For LVPECL:
 - i. A balun can be used, or
 - ii. One side of the LVPECL signal can be terminated with a 50-ohm load and the other side can be run single-ended to the instrument.
 - c. For LVCMOS:
 - i. There are two single-ended outputs, CLKoutX and CLKoutX*, and each can be set to Normal, Inverted, or Off. are nine (9) combinations of LVCMOS in the Clock Output list.
 - ii. One side of the LVCMOS signal can be terminated with a 50-ohm load and the side can be run single-ended to the instrument.
 - iii. A balun may also be used. Ensure CLKoutX and CLKoutX* states are

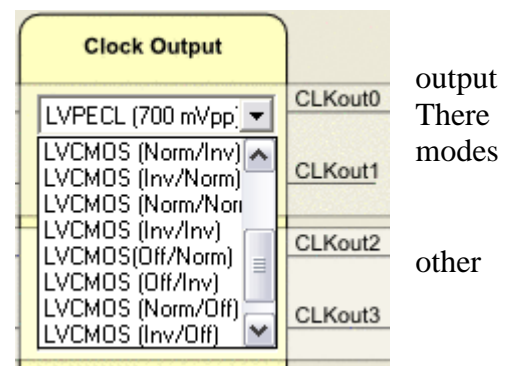

Figure 7: Setting LVCMOS modes

complementary to each other, i.e.: Norm/Inv or Inv/Norm.

5. The phase noise may be measured with a spectrum analyzer or signal source analyzer.

See Appendix B: Typical Phase Noise Performance Plots for phase noise plots of the clock outputs.

Texas Instruments Incorporated's Clock Design Tool can be used to calculate divider values to achieve desired clock output frequencies. See: <http://www.ti.com/tool/clockdesigntool>.

PLL Loop Filters and Loop Parameters

In jitter cleaning applications that use a cascaded or dual PLL architecture, the first PLL's purpose is to substitute the phase noise of a low-noise oscillator (VCXO or crystal resonator) for the phase noise of a "dirty" reference clock. The first PLL is typically configured with a narrow loop bandwidth in order to minimize the impact of the reference clock phase noise. The reference clock consequently serves only as a frequency reference rather than a phase reference.

The loop filters on the LMK048xx evaluation board are setup using the approach above. The loop filter for PLL1 has been configured for a narrow loop bandwidth (< 100 Hz), while the loop filter of PLL2 has been configured for a wide loop bandwidth (> 100 kHz). The specific loop bandwidth values depend on the phase noise performance of the oscillator mounted on the board. The following tables contain the parameters for PLL1 and PLL2 for each oscillator option.

Texas Instruments Incorporated's Clock Design Tool can be used to optimize PLL phase noise/jitter for given specifications. See: <http://www.ti.com/tool/clockdesigntool/>.

PLL 1 Loop Filter

Table 4: PLL1 Loop Filter Parameters for Crystek 122.88 MHz VCXO

122.88 MHz VCXO PLL			
Phase Margin	49°	Kϕ (Charge Pump)	100 μ A
Loop Bandwidth	12 Hz	Phase Detector Freq	1.024 MHz
		VCO Gain	2.5 kHz/Volt
Reference Clock Frequency	122.88 MHz	Output Frequency	122.88 MHz (To PLL 2)
Loop Filter Components	C1_A1 = 100 nF	C2_A1 = 680 nF	R2_A1 = 39 k Ω

Note: PLL Loop Bandwidth is a function of K ϕ , K_{vco}, N as well as loop components. Changing K ϕ and N will change the loop bandwidth.

PLL2 Loop Filter

Table 5: PLL2 Loop Filter Parameters for LMK048xxB

Integrated VCO PLL					
	LMK04803B	LMK04805B	LMK04806B	LMK04808B	
C1_A2	0.047				nF
C2_A2	3.9				nF
C3 (internal)	0				nF
C4 (internal)	0				nF
R2_A2	0.62				k Ω
R3 (internal)	0.2				k Ω
R4 (internal)	0.2				k Ω
Charge Pump Current, $K\phi$	3.2				mA
Phase Detector Frequency	122.88				MHz
Frequency	1966.08	2211.84	2457.6	2949.12	MHz
Kvco	17.9	16.5	18.8	32.3	MHz/V
N	16	18	20	24	
Phase Margin	75	75	75	76	degrees
Loop Bandwidth	355	320	321	424	kHz

Note: PLL Loop Bandwidth is a function of $K\phi$, Kvco, N as well as loop components. Changing $K\phi$ and N will change the loop bandwidth.

Evaluation Board Inputs and Outputs

The following table contains descriptions of the inputs and outputs for the evaluation board. Unless otherwise noted, the connectors described can be assumed to be populated by default. Additionally, some applicable CodeLoader programming controls are noted for convenience. Refer to the [LMK04800 Family Datasheet](#) for complete register programming information.

Table 6: Evaluation Board Inputs and Outputs

Connector Name	Signal Type, Input/Output	Description																										
<p><u>Populated:</u> CLKout0, CLKout0*, CLKout2, CLKout2*, CLKout4, CLKout4*, CLKout6, CLKout6*, CLKout8, CLKout8*, CLKout10, CLKout10*</p> <p><u>Not Populated:</u> CLKout1, CLKout1*, CLKout3, CLKout3*, CLKout5, CLKout5*, CLKout7, CLKout7*, CLKout9, CLKout9*, CLKout11, CLKout11*</p>	<p>Analog, Output</p>	<p>Clock outputs with programmable output buffers.</p> <p>The output terminations by default on the evaluation board are shown below, and the output type selected by default in CodeLoader is indicated by an asterisk (*):</p> <table border="1" data-bbox="721 793 1378 1325"> <thead> <tr> <th data-bbox="721 793 1003 865">Clock output pair</th> <th data-bbox="1003 793 1378 865">Default Board Termination</th> </tr> </thead> <tbody> <tr> <td data-bbox="721 865 1003 903">CLKout0</td> <td data-bbox="1003 865 1378 903">LVPECL*</td> </tr> <tr> <td data-bbox="721 903 1003 940">CLKout1</td> <td data-bbox="1003 903 1378 940">LVPECL</td> </tr> <tr> <td data-bbox="721 940 1003 978">CLKout2</td> <td data-bbox="1003 940 1378 978">LVPECL*</td> </tr> <tr> <td data-bbox="721 978 1003 1016">CLKout3</td> <td data-bbox="1003 978 1378 1016">LVPECL</td> </tr> <tr> <td data-bbox="721 1016 1003 1054">CLKout4</td> <td data-bbox="1003 1016 1378 1054">LVDS* / LVCMOS</td> </tr> <tr> <td data-bbox="721 1054 1003 1092">CLKout5</td> <td data-bbox="1003 1054 1378 1092">LVDS / LVCMOS</td> </tr> <tr> <td data-bbox="721 1092 1003 1129">CLKout6</td> <td data-bbox="1003 1092 1378 1129">LVDS* / LVCMOS</td> </tr> <tr> <td data-bbox="721 1129 1003 1167">CLKout7</td> <td data-bbox="1003 1129 1378 1167">LVDS / LVCMOS</td> </tr> <tr> <td data-bbox="721 1167 1003 1205">CLKout8</td> <td data-bbox="1003 1167 1378 1205">LVDS* / LVCMOS</td> </tr> <tr> <td data-bbox="721 1205 1003 1243">CLKout9</td> <td data-bbox="1003 1205 1378 1243">LVDS / LVCMOS</td> </tr> <tr> <td data-bbox="721 1243 1003 1281">CLKout10</td> <td data-bbox="1003 1243 1378 1281">LVPECL*</td> </tr> <tr> <td data-bbox="721 1281 1003 1325">CLKout11</td> <td data-bbox="1003 1281 1378 1325">LVPECL</td> </tr> </tbody> </table> <p>Each CLKout pair has a programmable LVDS, LVPECL, or LVCMOS buffer. The output buffer type can be selected in CodeLoader in the Clock Outputs tab via the CLKoutX_TYPE control.</p> <p>All clock outputs are AC-coupled to allow safe testing with RF test equipment.</p> <p>All LVPECL clock outputs are source-terminated using 240-ohm resistors.</p> <p>If an output pair is programmed to LVCMOS, each output can be independently configured (normal, inverted, or off/tri-state).</p>	Clock output pair	Default Board Termination	CLKout0	LVPECL*	CLKout1	LVPECL	CLKout2	LVPECL*	CLKout3	LVPECL	CLKout4	LVDS* / LVCMOS	CLKout5	LVDS / LVCMOS	CLKout6	LVDS* / LVCMOS	CLKout7	LVDS / LVCMOS	CLKout8	LVDS* / LVCMOS	CLKout9	LVDS / LVCMOS	CLKout10	LVPECL*	CLKout11	LVPECL
Clock output pair	Default Board Termination																											
CLKout0	LVPECL*																											
CLKout1	LVPECL																											
CLKout2	LVPECL*																											
CLKout3	LVPECL																											
CLKout4	LVDS* / LVCMOS																											
CLKout5	LVDS / LVCMOS																											
CLKout6	LVDS* / LVCMOS																											
CLKout7	LVDS / LVCMOS																											
CLKout8	LVDS* / LVCMOS																											
CLKout9	LVDS / LVCMOS																											
CLKout10	LVPECL*																											
CLKout11	LVPECL																											

Connector Name	Signal Type, Input/Output	Description						
<p style="text-align: center;"><u>Populated:</u> OSCout0, OSCout0*, OSCout1, OSCout1*</p>	<p>Analog, Output</p>	<p>Buffered outputs of OSCin port.</p> <p>The output terminations on the evaluation board are shown below, the output type selected by default in CodeLoader is indicated by an asterisk (*):</p> <table border="1" data-bbox="722 468 1377 619"> <thead> <tr> <th data-bbox="722 468 1003 539">OSC output pair</th> <th data-bbox="1003 468 1377 539">Default Board Termination</th> </tr> </thead> <tbody> <tr> <td data-bbox="722 539 1003 577">OSCout0</td> <td data-bbox="1003 539 1377 577">LVDS* / LVCMOS</td> </tr> <tr> <td data-bbox="722 577 1003 619">OSCout1</td> <td data-bbox="1003 577 1377 619">LVPECL* (fixed)</td> </tr> </tbody> </table> <p>Only OSCout0 has a programmable LVDS, LVPECL, or LVCMOS output buffer. The OSCout0 buffer type can be selected in CodeLoader on the Clock Outputs tab via the OSCout0_TYPE control. OSCout1 has LVPECL buffer only but has programmable swing amplitude.</p> <p>Both OSCout pairs are AC-coupled to allow safe testing with RF test equipment.</p> <p>The OSCout1 output is source-terminated using 240-ohm resistors.</p> <p>If OSCout0 is programmed as LVCMOS, each output can be independently configured (normal, inverted, inverted, and off/tri-state).</p>	OSC output pair	Default Board Termination	OSCout0	LVDS* / LVCMOS	OSCout1	LVPECL* (fixed)
OSC output pair	Default Board Termination							
OSCout0	LVDS* / LVCMOS							
OSCout1	LVPECL* (fixed)							
<p>Vcc</p>	<p>Power, Input</p>	<p>Main power supply input for the evaluation board.</p> <p>A 3.9 V DC power source applied to this SMA will, by default, source the onboard LDO regulators that power the inner layer planes that supply the LMK048xxB and its auxiliary circuits (e.g. VCXO).</p> <p>The LMK048xxB contains internal voltage regulators for the VCO, PLL and other internal blocks. The clock outputs do not have an internal regulator, so a clean power supply with sufficient output current capability is required for optimal performance.</p> <p>On-board LDO regulators and 0 Ω resistor options provide flexibility to supply and route power to various devices. See schematics for more details.</p>						

Connector Name	Signal Type, Input/Output	Description
<u>Populated:</u> J1	Power, Input	Alternative power supply input for the evaluation board using two unshielded wires (Vcc and GND). Apply power to either Vcc SMA or J1, but not both.
<u>Populated:</u> VccVCO/Aux	Power, Input	Optional Vcc input to power the VCO circuit if separated voltage rails are needed. The VccVCO/Aux input can power these circuits directly or supply the on-board LDO regulators. 0 Ω resistor options provide flexibility to route power.
<u>Populated:</u> VccVCXO/Aux	Power, Input	Optional Vcc input to power the VCXO circuit if separated voltage rails are needed. The VccVCXO/Aux input can power these circuits directly or supply the on-board LDO regulators. 0 Ω resistor options provide flexibility to route power.

Connector Name	Signal Type, Input/Output	Description															
<p>Populated: CLKin0, CLKin0*, FBCLKin*/CLKin1*</p> <p>Not Populated: FBCLKin/CLKin1</p>	<p>Analog, Input</p>	<p>Reference Clock Inputs for PLL1 (CLKin0, 1). CLKin1 can alternatively be used as an External Feedback Clock Input (FBCLKin) in 0-delay mode or an RF Input (Fin) in External VCO mode.</p> <p>Reference Clock Inputs for PLL1 (CLKin0, 1) FBCLKin/CLKin1* is configured by default for a single-ended reference clock input from a 50-ohm source. The non-driven input pin (FBCLKin/CLKin1) is connected to GND with a 0.1 uF. CLKin0/CLKin0* is configured by default for a differential reference clock input from a 50-ohm source.</p> <p>CLKin1* is the default reference clock input selected in CodeLoader. The clock input selection mode can be programmed on the Bits/Pins tab via the CLKin_Select_MODE control. Refer to the LMK04800 Family Datasheet section “Input Clock Switching” for more information.</p> <p>AC coupled Input Clock Swing Levels</p> <table border="1" data-bbox="708 1052 1391 1165"> <thead> <tr> <th>Input</th> <th>Mode</th> <th>Min</th> <th>Max</th> <th>Units</th> </tr> </thead> <tbody> <tr> <td>Differential</td> <td>Bipolar or</td> <td>0.5</td> <td>3.1</td> <td>Vpp</td> </tr> <tr> <td>Single Ended</td> <td>CMOS</td> <td>0.25</td> <td>2.4</td> <td>Vpp</td> </tr> </tbody> </table> <p>External Feedback Input (FBCLKin) for 0-Delay CLKin1 is shared for use with FBCLKin as an external feedback clock input to PLL1 for 0-delay mode. See section, Programming 0-Delay Mode in CodeLoader below, for more details on using 0-delay mode with the evaluation board and the evaluation board software.</p> <p>RF Input (Fin) for External VCO CLKin1 is also shared for use with Fin as an RF input for external VCO mode using the onboard VCO footprint (U3) or add-on VCO board. To enable Dual PLL mode with External VCO, the following registers must be properly configured in CodeLoader:</p> <ul style="list-style-type: none"> MODE = (3) Dual PLL, Ext VCO (Fin), (5) Dual PLL, Ext VCO, 0-Delay, (11) PLL2, Ext VCO (Fin) 	Input	Mode	Min	Max	Units	Differential	Bipolar or	0.5	3.1	Vpp	Single Ended	CMOS	0.25	2.4	Vpp
Input	Mode	Min	Max	Units													
Differential	Bipolar or	0.5	3.1	Vpp													
Single Ended	CMOS	0.25	2.4	Vpp													

Connector Name	Signal Type, Input/Output	Description
<p><u>Not populated:</u> OSCin, OSCin*</p>	<p>Analog, Input</p>	<p>Feedback VCXO clock input to PLL1 and Reference clock input to PLL2.</p> <p>By default, these SMAs are not connected to the traces going to the OSCin/OSCin* pins of the LMK048xxB. Instead, the single-ended output of the onboard VCXO (U2) drives the OSCin* input of the device and the OSCin input of the device is connected to GND with 0.1 uF.</p> <p>A VCXO add-on board may be optionally attached via these SMA connectors with minor modification to the components going to the OSCin/OSCin* pins of device. This is useful if the VCXO footprint does not accommodate the desired VCXO device.</p> <p>A single-ended or differential signal may be used to drive the OSCin/OSCin* pins and must be AC coupled. If operated in single-ended mode, the unused input must be connected to GND with 0.1 uF.</p> <p>Refer to the LMK04800 Family Datasheet section “Electrical Characteristics” for PLL2 Reference Input (OSCin) specifications.</p>
<p><u>Test point:</u> VTUNE1_TP</p> <p><u>Not populated:</u> Vtune1</p>	<p>Analog, Output</p>	<p>Tuning voltage output from the loop filter for PLL1.</p> <p>If a VCXO add-on board is used, this tuning voltage can be connected to the voltage control pin of the external VCXO when this SMA connector is installed and connected through R72 by the user.</p>
<p><u>Test point:</u> VTUNE2_TP</p>	<p>Analog, Output</p>	<p>Tuning voltage output from the loop filter for PLL2.</p>
<p><u>Populated:</u> uWire</p> <p><u>Test points:</u> DATAuWire_TP CLKuWIRE_TP LEuWIRE_TP</p>	<p>CMOS, Input/Output</p>	<p>10-pin header for uWire programming interface and programmable logic I/O pins for the LMK048xxB.</p> <p>The uWire interface includes CLKuWire, DATAuWire, and LEuWire signals.</p> <p>The programmable logic I/O signals accessible through this header include: SYNC, Status_Holdover, Status_LD, Status_CLKin0, and Status_CLKin1. These logic I/O signals also have dedicated SMAs and test points.</p>

Connector Name	Signal Type, Input/Output	Description
<p><u>Test point:</u> LD_TP</p> <p><u>Not populated:</u> Status_LD</p>	<p>CMOS, Output</p>	<p>Programmable status output pin. By default, set to output the digital lock detect status signal for PLL1 and PLL2 combined.</p> <p>In the default CodeLoader modes, LED D5 will illuminate green when PLL lock is detected by the LMK048xxB (output is high) and turn off when lock is lost (output is low).</p> <p>The status output signal for the Status_LD pin can be selected on the Bits/Pins tab via the LD_MUX control.</p> <p>Refer to the LMK04800 Family Datasheet section “Status Pins” and “Digital Lock Detect” for more information.</p> <p>Note: Before a high-frequency internal signal (e.g. PLL divider output signal) is selected by LD_MUX, it is suggested to first remove the 270 ohm resistor to prevent the LED from loading the output.</p>
<p><u>Test point:</u> Holdover_TP</p> <p><u>Not populated:</u> Status_Hold</p>	<p>CMOS, Output</p>	<p>Programmable status output pin. By default, set to the output holdover mode status signal.</p> <p>In the default CodeLoader mode, LED D8 will illuminate red when holdover mode is active (output is high) and turn off when holdover mode is not active (output is low).</p> <p>The status output signal for the Status_Holdover pin can be selected on the Bits/Pins tab via the HOLDOVER_MUX control.</p> <p>Refer to the LMK04800 Family Datasheet section “Status Pins” and “Holdover Mode” for more information.</p> <p>Note: Before a high-frequency internal signal (e.g. PLL divider output signal) is selected by HOLDOVER_MUX, it is suggested to first remove the 270 ohm resistor to prevent the LED from loading the output.</p>

Connector Name	Signal Type, Input/Output	Description																											
<p>Test point: CLKin0_SEL_TP CLKin1_SEL_TP</p> <p>Not populated: Status_CLKin0, Status_CLKin1</p>	<p>CMOS, Input/Output</p>	<p>Programmable status I/O pins. By default, set as input pins for controlling input clock switching of CLKin0 and CLKin1.</p> <p>These inputs will not be functional because CLKin_Select_MODE is set to 0 (CLKin0 Manual) by default in the Bits/Pins tab in CodeLoader. To enable input clock switching, CLKin_Select_MODE must be 3 or 6 and Status_CLKinX_TYPE must be 0 to 3 (pin enabled as an input).</p> <p>Input Clock Switching – Pin Select Mode When CLKin_SELECT_MODE is 3, the Status_CLKinX pins select which clock input is active as follows:</p> <table border="1" data-bbox="695 835 1404 1029"> <thead> <tr> <th>Status_CLKin1</th> <th>Status_CLKin0</th> <th>Active Clock</th> </tr> </thead> <tbody> <tr> <td>0</td> <td>0</td> <td>CLKin0</td> </tr> <tr> <td>0</td> <td>1</td> <td>CLKin1</td> </tr> <tr> <td>1</td> <td>0</td> <td>Reserved</td> </tr> <tr> <td>1</td> <td>1</td> <td>Holdover</td> </tr> </tbody> </table> <p>Input Clock Switching – Auto with Pin Select When CLKin_SELECT_MODE is 6, the active clock is selected using the Status_CLKinX pins upon an input clock switch event as follows:</p> <table border="1" data-bbox="708 1209 1391 1402"> <thead> <tr> <th>Status_CLKin1</th> <th>Status_CLKin0</th> <th>Active Clock</th> </tr> </thead> <tbody> <tr> <td>X</td> <td>0</td> <td>CLKin0</td> </tr> <tr> <td>1</td> <td>0</td> <td>CLKin1</td> </tr> <tr> <td>0</td> <td>0</td> <td>Reserved</td> </tr> </tbody> </table> <p>Refer to the LMK04800 Family Datasheet section “Input Clock Switching” for more information.</p> <p>Status Outputs When Status_CLKinX_TYPE is 3 to 6 (pin enabled as an output), the status output signal for the corresponding Status_CLKinX pin can be programmed on the Bits/Pins tab via the Status_CLKinX_MUX control.</p> <p>Refer to the LMK04800 Family Datasheet section “Status Pins” for more information.</p>	Status_CLKin1	Status_CLKin0	Active Clock	0	0	CLKin0	0	1	CLKin1	1	0	Reserved	1	1	Holdover	Status_CLKin1	Status_CLKin0	Active Clock	X	0	CLKin0	1	0	CLKin1	0	0	Reserved
Status_CLKin1	Status_CLKin0	Active Clock																											
0	0	CLKin0																											
0	1	CLKin1																											
1	0	Reserved																											
1	1	Holdover																											
Status_CLKin1	Status_CLKin0	Active Clock																											
X	0	CLKin0																											
1	0	CLKin1																											
0	0	Reserved																											

Connector Name	Signal Type, Input/Output	Description
<p style="text-align: center;"> <u>Test point:</u> SYNC_TP <u>Not populated:</u> SYNC </p>	<p style="text-align: center;"> CMOS, Input/Output </p>	<p>Programmable status I/O pin. By default, set as an input pin for synchronize the clock outputs with a fixed and known phase relationship between each clock output selected for SYNC. A SYNC event also causes the digital delay values to take effect.</p> <p>In the default CodeLoader mode, SYNC will asserted when the SYNC pin is low and the outputs to be synchronized will be held in a logic low state. When SYNC is unasserted, the clock outputs to be synchronized are activated and will be initially phase aligned with each other except for outputs programmed with different digital delay values.</p> <p>A SYNC event can also be programmed by toggling the SYNC_POL_INV bit in the Bits/Pins tab in CodeLoader.</p> <p>Refer to the LMK04800 Family Datasheet section “Clock Output Synchronization” for more information.</p> <p>Status Output When SYNC_MUX is 3 to 6 (pin enabled as output), a status signal for the SYNC pin can be selected on the Bits/Pins tab via the SYNC_MUX control.</p>

Recommended Test Equipment

Power Supply

The Power Supply should be a low noise power supply, particularly when the devices on the board are being directly powered (onboard LDO regulators bypassed).

Phase Noise / Spectrum Analyzer

To measure phase noise and RMS jitter, an Agilent E5052 Signal Source Analyzer is recommended. An Agilent E4445A PSA Spectrum Analyzer with the Phase Noise option is also usable although the architecture of the E5052 is superior for phase noise measurements. At frequencies less than 100 MHz the local oscillator noise of the E4445A is too high and measurements will reflect the E4445A's internal local oscillator performance, not the device under test.

Oscilloscope

To measure the output clocks for AC performance, such as rise time or fall time, propagation delay, or skew, it is suggested to use a real-time oscilloscope with at least 1 GHz analog input bandwidth (2.5+ GHz recommended) with 50 ohm inputs and 10+ Gsps sample rate. To evaluate clock synchronization or phase alignment between multiple clock outputs, it's recommended to use phase-matched, 50-ohm cables to minimize external sources of skew or other errors/distortion that may be introduced if using oscilloscope probes.

Programming 0-Delay Mode in CodeLoader

Overview

When enabling the 0-Delay mode the feedback path of the VCO is altered to include a clock output. See the datasheet for more details on 0-Delay functionality.

The current version of the CodeLoader software does not include this extra divider in the frequency calculations when in holdover mode. To successfully lock the LMK04800 device in a 0-Delay mode the user must program the device “manually” account for this divider. Programming “manually” means that the VCO frequency and therefore the clock output frequencies displayed by the CodeLoader software may be incorrect. For the LMK04800 device to lock properly the **divider values** must be programmed correctly. The frequencies displayed in the application are only for the benefit of the user and for proper automatic programming of the OSCin_FREQ register which will not be affected by 0-Delay.

When using the device in Dual Loop mode vs. Single Loop mode different procedures are used to cause the device to lock when using the CodeLoader software. The following two sections describe the process for when the LMK04800 device is programmed for a Dual Loop mode and Single Loop mode respectively. Each section contains a brief introduction, the programming steps to execute to make the device lock, and finally a detailed section discussing the workaround and some example cases.

Dual Loop 0-Delay Mode Examples

In Dual Loop 0-Delay Modes, MODE = 2 or MODE = 5, the feedback from the VCXO of PLL1 to the PLL1 N divider is broken and a clock output will drive the PLL1 N divider. This permits phase alignment between the clock output and the clock input (0-Delay). As such, the PLL1_N and PLL1_R divide values may need to be adjusted to permit the LMK04800 to lock.

Programming Steps

1. Program a Dual Loop 0-Delay mode.
2. Enable the feedback mux. EN_FEEDBACK_MUX = 1.
3. Select clock output for feedback with the feedback mux. FEEDBACK_MUX = User value.
4. Program the VCXO (VCO) frequency of PLL1 tab to the clock output frequency selected by the feedback mux.

If for any reason the CLKout frequency is less than the phase detector frequency, the PLL1 R divider must be increased so that the phase detector is at the same or lower value than the CLKout frequency.

Details

When using the CodeLoader software in Dual Loop 0-Delay mode, programming the VCXO (VCO) frequency of the PLL1 tab to the frequency of the feedback output clock will re-program the PLL1 N divider to allow the LMK04800 will be able to lock. The PLL1 loop has been altered and actual VCXO no longer directly feeds into PLL1 N divider. The VCXO is only used by the reference input of PLL2 now. The PLL2 reference frequency will remain at the VCXO frequency.

When the PLL1 VCXO frequency is different from the PLL2 reference frequency, a warning will be displayed on the clock outputs tab informing the user that PLL1 VCO and PLL2 reference frequency are mismatched and the one or more of the PLLs are out of lock. While there still could be an error in the

divider values which may cause a non-locked PLL, this warning by itself may no longer be assumed true. It is up to the user to ensure the PLL dividers are programmed correctly.

To illustrate the proper programming of the LMK04800 device in dual loop 0-delay mode the following case examples are provided. Note that in one of the cases, the feedback frequency from the clock output matches the VCXO frequency and CodeLoader will display the proper frequency values.

Dual Loop 0-Delay (MODE=2 or 5) Case 1: For example the default configuration, 122.88 MHz CLKIn, 122.88 MHz VCXO, of the LMK04808 has the following register programming.

	Case 1: Default Mode No 0-Delay	Case2: Default 0-Delay Mode (CLKout8 = 122.88 MHz)	Case 3: Default 0-Delay Mode (Updated CLKout8 = 245.76 MHz)	Case 4: Default 0-Delay Mode (Updated CLKout8 = 61.44 MHz)
Actual PLL1 VCXO Frequency	122.88	122.88	122.88	122.88
Reported PLL1 VCXO Frequency	122.88	122.88	61.44	245.76
PLL1 N	120	120	60	240
Actual PLL2 VCO Frequency	2949.12 MHz	2949.12 MHz	2949.12 MHz	2949.12 MHz
Reported PLL2 VCO Frequency	2949.12 MHz	2949.12 MHz	2949.12 MHz	2949.12 MHz
PLL2_N	12	12	12	12
PLL2_P (Pre-N)	2	2	2	2
PLL2 VCO Divider	Bypassed	Bypassed	Bypassed	Bypassed
CLKout8 Divide	12	24	12	48
Actual CLKout8 Output Frequency	245.76 MHz	122.88 MHz	245.76 MHz	61.44 MHz
Reported CLKout8 Output Frequency	245.76 MHz	122.88 MHz	245.76 MHz	61.44 MHz

Single Loop 0-Delay Mode Examples

In Single Loop 0-Delay Mode, $MODE = 8$, the feedback from the VCO of PLL2 to the PLL2_P/PLL2_N divider is broken and a feedback clock output will drive the PLL2_N divider directly. This permits phase alignment between the clock output and the OSCin input (0-Delay). As such, the PLL2_N, PLL2_R, and PLL2_N_CAL divide values may need to be adjusted to permit the LMK04800 to lock.

Programming Steps

1. Program the Single Loop 0-Delay mode.
2. Enable the feedback mux. $EN_FEEDBACK_MUX = 1$.
3. Select clock output for feedback with the feedback mux. $FEEDBACK_MUX = \text{User value}$.
4. Program the VCO frequency of PLL2 tab to: The actual VCO frequency * PLL2_P (which is PLL2 PreN) / CLKout Divider.
 - Entered CodeLoader 4 VCO Frequency = Actual VCO Frequency * PLL2_P / CLKout Divider.
5. Updated the PLL2_N_CAL register on the Bits/Pins tab to the N value when in non-0-Delay mode.
6. Press Ctrl-L to cause all registers to be programmed.
 - The reason is to cause the programming of register R30 to start the VCO calibration routine now that the proper PLL2_N_CAL value is programmed.
 - PLL2_N_CAL value is automatically updated when a new VCO frequency is entered and the PLL2_N value is calculated. In this case the VCO frequency entered is wrong and the PLL2_N_CAL value will be incorrect.

If for any reason the CLKout frequency is less than the phase detector frequency, the PLL2 R divider must be increased so that the phase detector is at the same or lower value than the CLKout frequency.

Details

The 0-Delay mode for Single Loop mode is more complicated to program than for Dual Loop mode in part because of the PLL2_N_CAL register. When performing the VCO calibration the device uses PLL2_N_CAL for in non-0-Delay mode. Once the VCO is calibrated the device enters 0-Delay mode. For more information on the PLL programming equations, refer to PLL PROGRAMMING in the applications section of the datasheet.

In Table 7 case 1 illustrates the register programming when not using 0-Delay.

Case 2 shows 0-Delay with a clock out divider of 2. Since $PLL2_P = 2$, this substitution of which circuit is performing the divide by two results in no impact on the software. All the values display correctly.

Case 3 shows 0-Delay mode with a CLKout divider not equal to the PLL2_P value. So the proper frequency to program in the VCO to lock the VCO to 2949.12 MHz will be 491.52 MHz. This is calculated by Actual VCO Frequency * PLL2_P / CLKoutX_Y_DIV.

Case 4 shows 0-Delay mode with CLKout divider not equal to the PLL2_P value; however the CLKout frequency will be less than the current phase detector frequency. This requires PLL2_R to be increased from a value of 1 to 2 to reduce the PLL2 phase detector frequency from 122.88 MHz to 61.44 MHz. Now the adjusted VCO frequency can be programmed to allow PLL2 to lock.

In any case where the actual VCO frequency and the display VCO frequency are not equal the user is required to manually update the PLL2_N_CAL register with the PLL2_N value to be used as if the device were operating in the non-0-Delay mode. Once this update has been performed, Ctrl-L will reload the part and cause the VCO calibration to occur with the proper PLL2_N_CAL value.

Table 7 - Single PLL 0-Delay Operation Examples

	Case 1: Default Mode No 0-Delay	Case 2: Default 0-Delay Mode (CLKout8 = 1474.56 MHz)	Case 3: Default 0-Delay Mode (Updated CLKout8 = 245.76 MHz)	Case 4: Default 0-Delay Mode (Updated CLKout8 = 61.44 MHz)
Actual PLL2 VCO Frequency	2949.12 MHz	2949.12 MHz	2949.12 MHz	2949.12 MHz
Reported PLL2 VCO Frequency	2949.12 MHz	2949.12 MHz	491.52 MHz	122.88 MHz
PLL2_R	1	1	1	2
PLL2_N	12	12	2	1
PLL2_N_CAL	12	12	12	24
PLL2_P (Pre-N)	2	2	2	2
PLL2 VCO Divider	Bypassed	Bypassed	Bypassed	Bypassed
CLKout8 Divide	12	2	12	48
Actual CLKout8 Output Frequency	245.76	1474.56 MHz	245.76 MHz	61.44 MHz
Reported CLKout8 Output Frequency	245.76	1474.56 MHz	40.96 MHz	2.56 MHz

Appendix A: CodeLoader Usage

Code Loader is used to program the evaluation board with LPT or USB2ANY-uWire interface available from www.ti.com.

Port Setup Tab

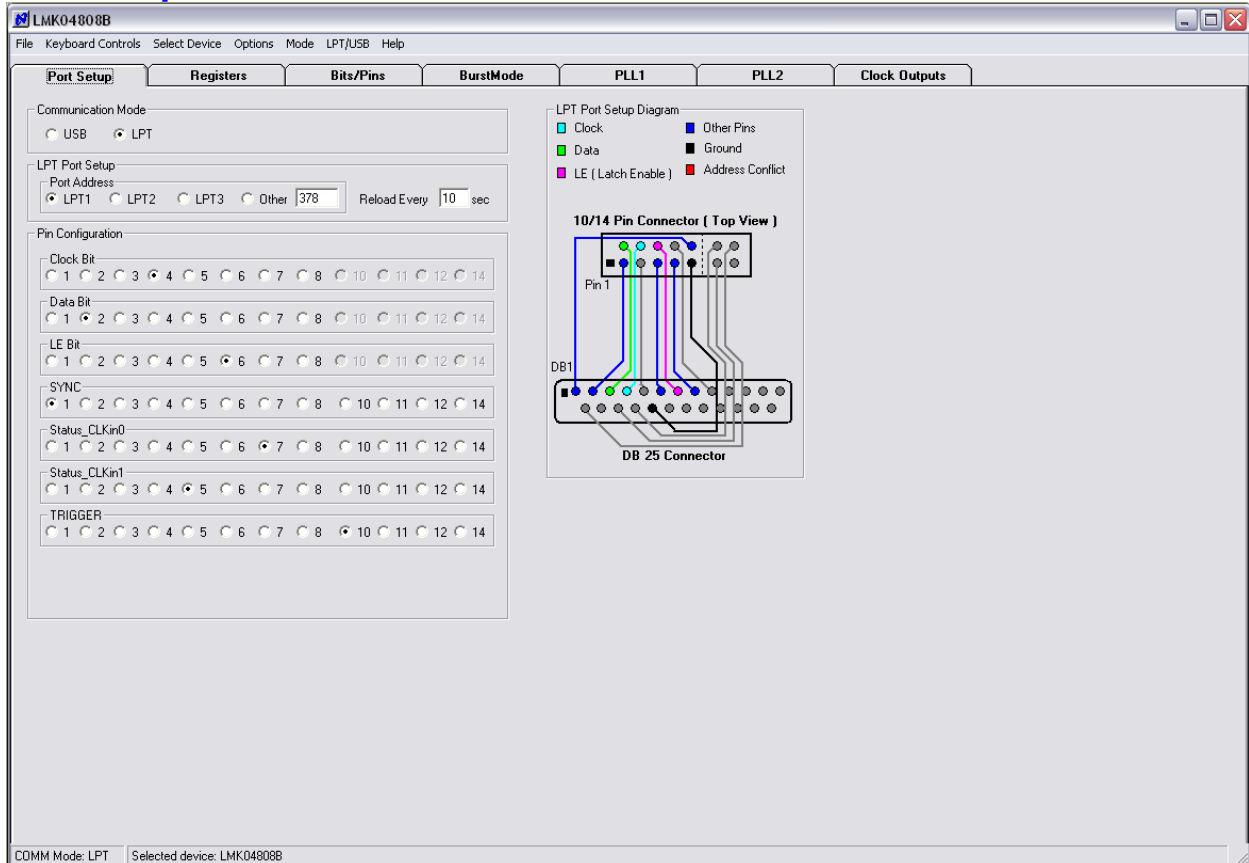

Figure 8: Port Setup tab

On the Port Setup tab, the user may select the type of communication port (LPT or USB) that will be used to program the device on the evaluation board.

The Pin Configuration field is hardware dependent and normally **does not** need to be changed by the user. Figure 8 shows the default settings.

Clock Outputs Tab

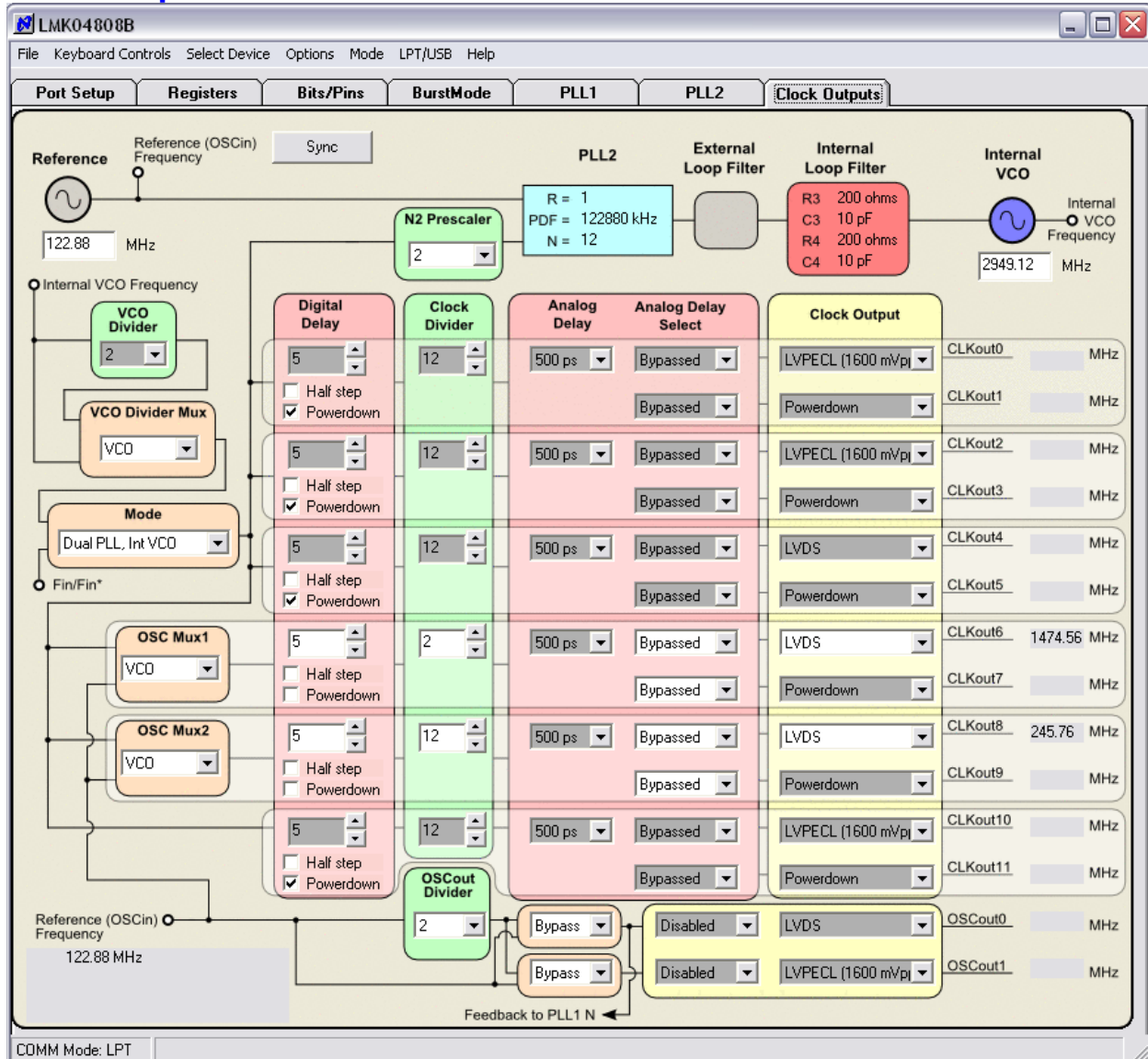

Figure 9: Clock Outputs tab

The **Clock Outputs** tab allows the user to control the output channel blocks, including:

- Clock Group Source from either VCO or OSCin (via OSC Mux1 and OSC Mux2)
- Channel Powerdown (affects digital and analog delay, clock divider, and buffer blocks)
- Digital Delay value and Half Step
- Clock Divide value
- Analog Delay value and Delay bypass/enable (per output)
- Clock Output format (per output)

This tab also allows the user to select the VCO Divider value (2 to 8). Note that the *total* PLL2 N divider value is the product of the VCO Divider value and the PLL N Prescaler and N Counter

values (shown in the **PLL2** tab), and is given by:

$$\text{PLL2 N Total} = \text{VCO Divider} * \text{PLL2 N Prescaler} * \text{PLL2 N Counter}$$

Clicking on the cyan-colored PLL2 block that contains R, PDF and N values will bring the **PLL2** tab into focus where these values may be modified, if needed.

Clicking on the values in the box containing the Internal Loop Filter component (R3, C3, R4, C4) allow one to step through the possible values. Left click to increase the component value, and right click to decrease the value. These values can also be changed in the **Bits/Pins** tab.

The Reference Oscillator value field may be changed in either the **Clock Outputs** tab or the **PLL2** tab. The PLL2 Reference frequency should match the frequency of the onboard VCXO or Crystal (i.e. VCO frequency in the **PLL1** tab); if not, a warning message will appear to indicate that the PLL(s) may be out of lock, as highlighted by the red box in Figure 10.

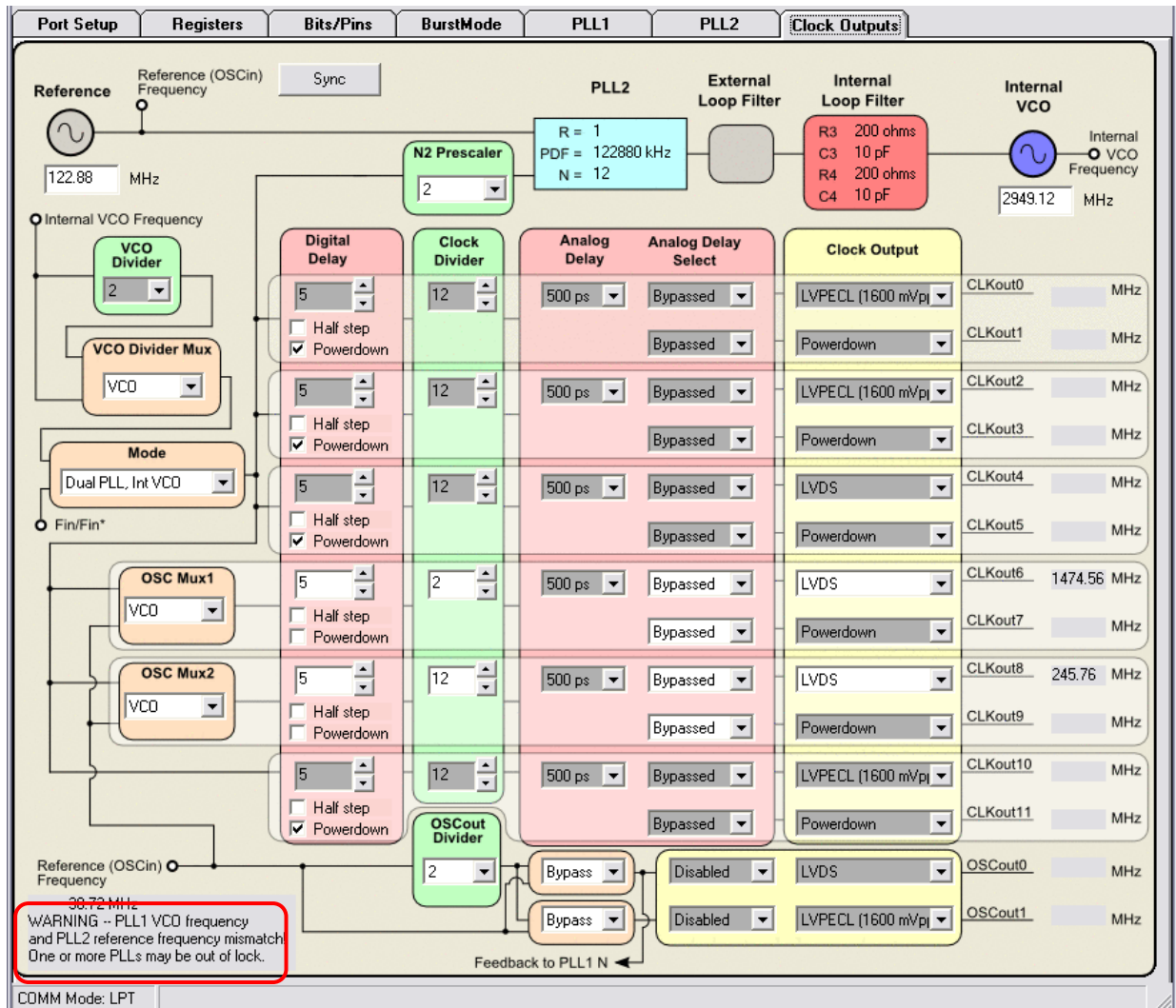

Figure 10: Warning message indicating mismatch between PLL1 VCO frequency (30.72MHz) and PLL2 reference frequency (122.88 MHz)

PLL1 Tab

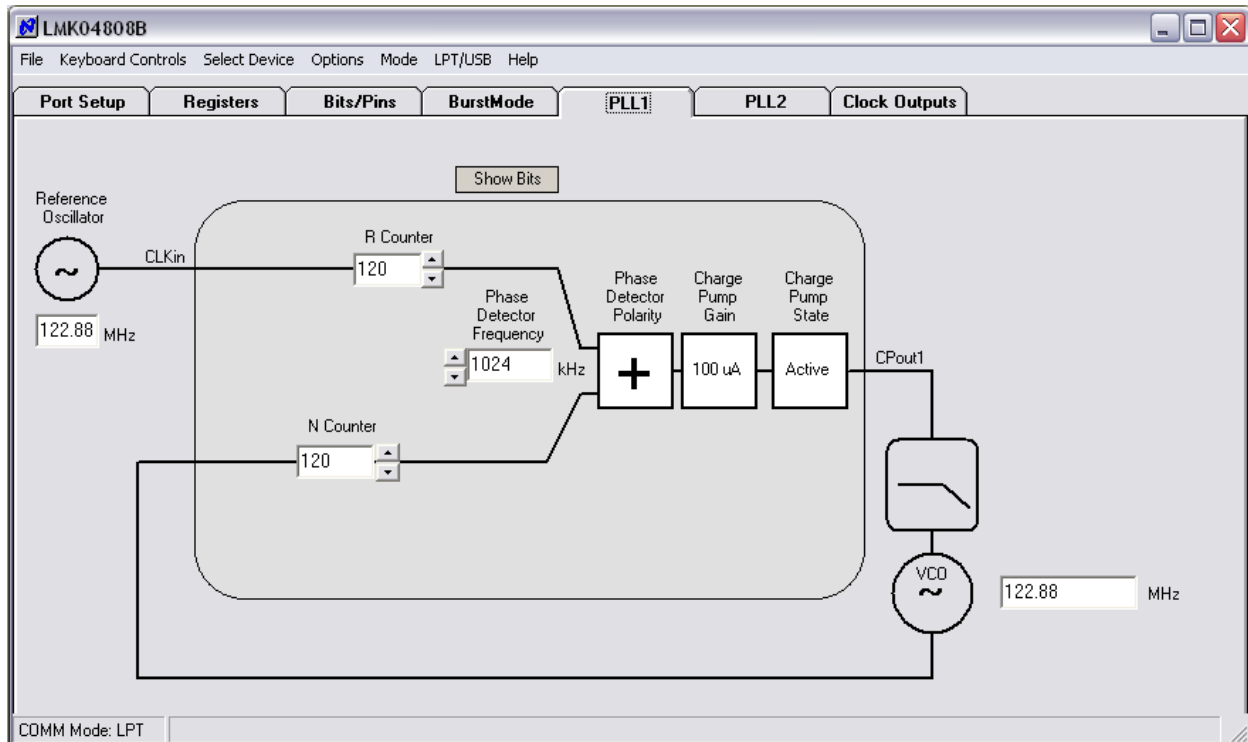

Figure 11: PLL1 tab

The PLL1 tab allows the user to change the following parameters in Table 8.

Table 8: Registers Controls and Descriptions in PLL1 tab

Control Name	Register Name	Description
Reference Oscillator Frequency (MHz)	n/a	CLKin frequency of the selected reference clock.
Phase Detector Frequency (MHz)	n/a	PLL1 Phase Detector Frequency (PDF). This value is calculated as: $\text{PLL1 PDF} = \text{CLKin Frequency} / (\text{PLL1_R} * \text{CLKinX_PreR_DIV})$ where CLKinX_PreR_DIV is the predivider value of the selected input clock.

VCO Frequency (MHz)	n/a	The VCO Frequency should be the OSCin frequency, except when operating in Dual PLL with 0-delay feedback. This value is calculated as: VCO Freq (OSCin freq) = PLL1 PDF * PLL1_N. In Dual PLL mode with 0-delay feedback, the VCO frequency should be set to the feedback clock input frequency. See the section Setting the PLL1 VCO Frequency and PLL2 Reference Frequency for details.
R Counter	PLL1_R	PLL1 R Counter value (1 to 16383).
N Counter	PLL1_N	PLL1 N Counter value (1 to 16383).
Phase Detector Polarity	PLL1_CP_POL	PLL1 Phase Detector Polarity. Click on the polarity sign to toggle polarity “+” or “-”.
Charge Pump Gain	PLL1_CP_GAIN	PLL1 Charge Pump Gain. Left-click/right-click to increase/decrease charge pump gain (100, 200, 400, 1600 uA).
Charge Pump State	PLL1_CP_TRI	PLL1 Charge Pump State. Click to toggle between Active and Tri-State.

Setting the PLL1 VCO Frequency and PLL2 Reference Frequency

When operating in Dual PLL mode without 0-delay feedback, the VCO frequency value on the **PLL1** tab must match the Reference Oscillator (OSCin) frequency value on the **PLL2** tab; otherwise, the one or both PLLs may be out of lock. Updating the Reference Oscillator frequency on the **PLL2** tab will automatically update the value of OSCin_FREQ on the **Bits/Pins** tab.

However, when operating in Dual PLL mode with 0-delay feedback, it may be valid for the VCO frequency value on the **PLL1** tab to be different from the Reference Oscillator (OSCin) frequency value on the **PLL2** tab. This is because in 0-delay mode, the PLL1 feedback clock is taken from an output clock instead of the OSCin clock. For example, if the CLKin frequency (to PLL1_R) is 30.72 MHz, the 0-delay feedback clock frequency (to PLL1_N) is 30.72 MHz, and the VCXO frequency is 122.88 MHz, then the VCO frequency value on the **PLL1** tab should be 30.72 MHz (0-delay feedback frequency) and the Reference Oscillator frequency value on the **PLL2** tab should be 122.88 MHz (VCXO frequency). Because of the mismatched frequencies, a warning message will indicate this condition on the **Clock Outputs** tab but may be disregarded in a case like this.

PLL2 Tab

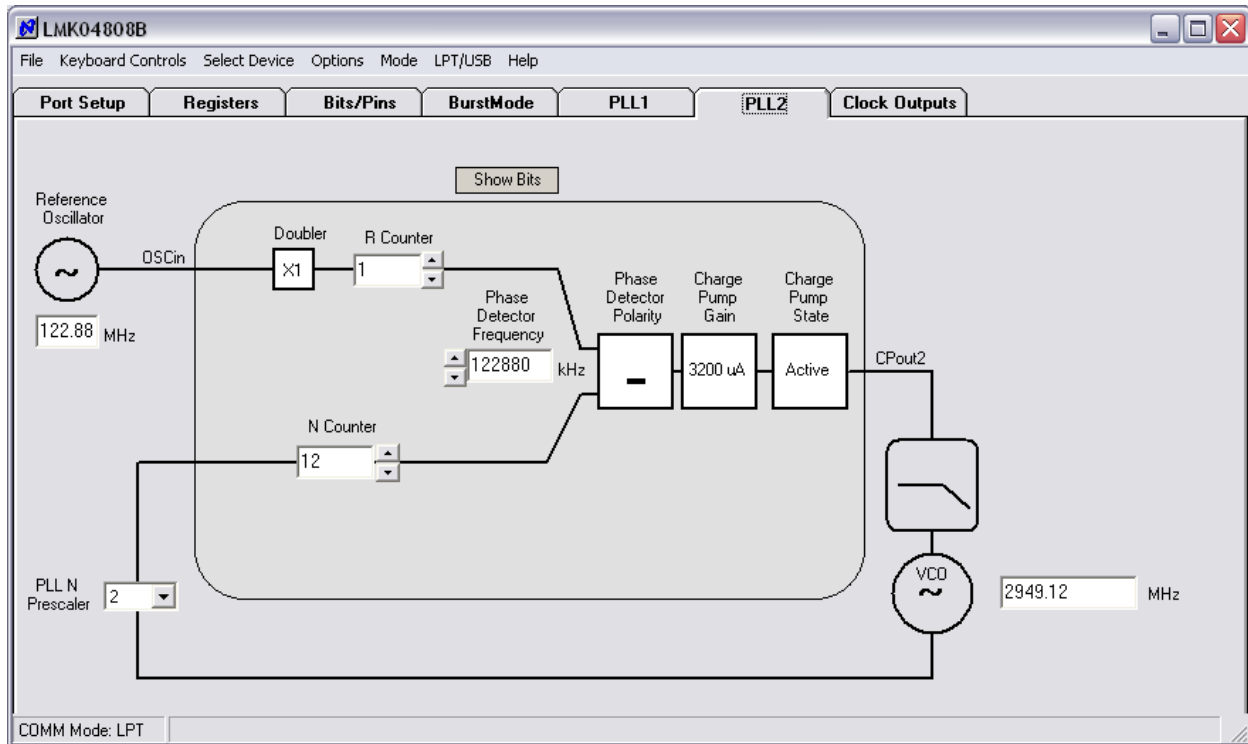

Figure 12: PLL2 tab

The PLL2 tab allows the user to change the following parameters in Table 9.

Table 9: Registers Controls and Descriptions in PLL2 tab

Control Name	Register Name	Description
Reference Oscillator Frequency (MHz)	OSCin_FREQ	OSCin frequency from the External VCXO or Crystal.
Phase Detector Frequency (MHz)	n/s	PLL2 Phase Detector Frequency (PDF). This value is calculated as: $\text{PLL2 PDF} = \text{OSCin Frequency} * (2^{\text{EN_PLL2_REF_2X}}) / \text{PLL2_R}.$
VCO Frequency (MHz)	n/a	Internal VCO Frequency should be within the allowable range of the LMK048xxB device. This value is calculated as: $\text{VCO Frequency} = \text{PLL2 PDF} * (\text{PLL2_N} * \text{PLL2_P} * \text{VCO divider value}).$
Doubler	EN_PLL2_REF_2X	PLL2 Doubler. 0 = Bypass Doubler 1 = Enable Doubler
R Counter	PLL2_R	PLL2 R Counter value (1 to 4095).
N Counter	PLL2_N	PLL2 N Counter value (1 to 262143).
PLLN Prescaler	PLL2_P	PLL2 N Prescaler value (2 to 8).

Phase Detector Polarity	PLL2_CP_POL	PLL2 Phase Detector Polarity. Click on the polarity sign to toggle polarity “+” or “-”.
Charge Pump Gain	PLL2_CP_GAIN	PLL2 Charge Pump Gain. Left-click/right-click to increase/decrease charge pump gain (100, 400, 1600, 3200 uA).
Charge Pump State	PLL2_CP_TRI	PLL2 Charge Pump State. Click to toggle between Active and Tri-State.

Changes made on this tab will be reflected in the **Clock Outputs** tab. The VCO Frequency should conform to the specified internal VCO frequency range for the LMK048xxB device (per Table 2).

Bits/Pins Tab

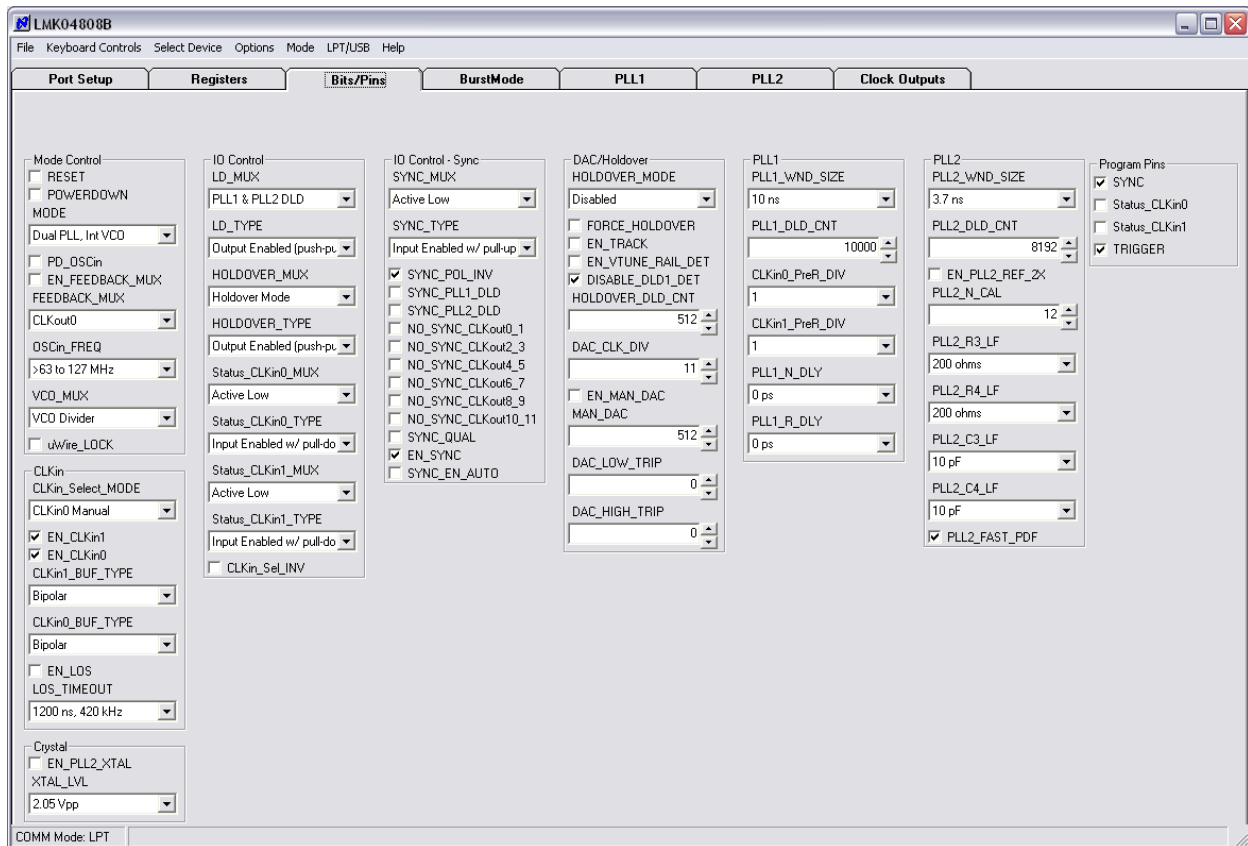

Figure 13: Bits/Pins tab

The **Bits/Pins** tab allows the user to program bits directly, many of which are not available on other tabs. Brief descriptions for the controls on this tab are provided in Table 10 to supplement the datasheet. Refer to the [LMK04800 Family Datasheet](#) for more information.

TIP: Right-clicking any register name in the **Bits/Pins** tab will display a Help prompt with the register address, data bit location/length, and a brief register description.

Table 10: Register Controls and Descriptions on Bits/Pins tab

Group	Register Name	Description
Mode Control	RESET	Resets the device to default register values. RESET must be cleared for normal operation to prevent an unintended reset every time R0 is programmed.
	POWERDOWN	Places the device in powerdown mode.
	MODE	Selects the operating mode (topology) for the LMK048xx device.
	PD_OSCin	Powers down the OSCin buffer. For use in Clock Distribution mode if OSCin path is not used.
	FEEDBACK_MUX	Selects the feedback source for 0-delay mode.
	OSCin_FREQ	Must be set to the OSCin frequency range for PLL2. Used for proper operation of the internal VCO calibration routine. Entering a reference oscillator frequency on PLL2 tab will automatically update OSCin_FREQ to the proper frequency range.
	VCO_MUX	Selects between VCO and VCO divider to drive the clock distribution path. The VCO divider is only valid if MODE is selecting the Internal VCO.
	uWire_LOCK	When checked, no other uWire programming will have effect. Must be unchecked to enable uWire programming of registers R0 to R30.
CLKin	CLKin_Select_MODE	Selects operational mode for how the device selects the reference clock for PLL1.
	EN_CLKin1	Enables CLKin1 as a usable reference input during auto switching mode.
	EN_CLKin0	Enables CLKin0 as a usable reference input during auto switching mode.
	CLKinX_BUF_TYPE	Selects the CLKinX input buffer to Bipolar (internal 0 mV offset) or MOS (internal 55 mV offset).
	EN_LOS	Enable the Loss-Of-Signal (LOS) detect circuitry.
	LOS_TIMEOUT	Sets the timeout value for the LOS detect circuitry to assert a loss of signal state on a clock input.
Crystal	EN_PLL2_XTAL	Enables Crystal Oscillator
	XTAL_LVL	Sets peak amplitude on the tunable crystal. Values listed are for a 20.48 MHz crystal.
IO Control	LD_MUX	Sets the selected signal on the Status_LD pin.
	LD_TYPE	Sets I/O pin type on the Status_LD pin.
	HOLDOVER_MUX	Sets the selected signal on the Status_HOLDOVER pin.

	HOLDOVER_TYPE	Sets I/O pin type on the Status_Holdover pin.
	Status_CLKin0_MUX	Sets the selected signal on the Status_CLKin0 pin.
	Status_CLKin0_TYPE	Sets I/O pin type on the Status_CLKin0 pin.
	Status_CLKin1_MUX	Sets the selected signal on the Status_CLKin1 pin.
	Status_CLKin1_TYPE	Sets I/O pin type on the Status_CLKin1 pin.
	CLKin_Sel_INV	Inverts the Status_CLKin0/1 pin polarity when set to an input type. Significant when CLKin_SELECT_MODE is 3 or 6.
IO Control – Sync	SYNC_MUX	Sets the selected signal on the SYNC pin.
	SYNC_TYPE	Sets I/O pin type on the SYNC pin.
	SYNC_POL_INV	Sets polarity on SYNC input to active low when checked. Toggling this bit will initiate a SYNC event.
	SYNC_PLL1_DLD	Engage SYNC mode until PLL1 DLD is true
	SYNC_PLL2_DLD	Engage SYNC mode until PLL2 DLD is true
	NO_SYNC_CLKoutX_Y	Synchronization will not affect selected clock outputs, where X = even-numbered output and Y = odd-numbered output.
	SYNC_QUAL	Sets the SYNC to qualify mode for dynamic digital delay.
	EN_SYNC	<p>Must be set when using SYNC, but may be cleared after the SYNC event. When using dynamic digital delay (SYNC_QUAL = 1), EN_SYNC must always be set.</p> <p>Changing this value from 0 to 1 can cause a SYNC event, so clocks which should not be SYNCed when setting this bit should have the NO_SYNC_CLKoutX_Y bit set.</p> <p>NOTE: This bit is not a valid method of generating a SYNC event. Use one of the other SYNC generation methods to ensure a proper SYNC occurs.</p>
SYNC_EN_AUTO	Enable auto SYNC when R0 to R5 is written.	
DAC/Holdover	HOLDOVER_MODE	Sets holdover mode to be disabled or enabled.
	FORCE_HOLDOVER	Engages holdover when checked regardless of HOLDOVER_MODE value. Turns the DAC on.
	EN_TRACK	Enables DAC tracking. DAC tracks the PLL1 Vtune to provide for an accurate HOLDOVER mode. DAC_CLK_DIV should also be set so that DAC update rate is <= 100 kHz.
	EN_VTUNE_RAIL_DET	Allows rail-to-rail operation of VCXO with default of 0. Allows use of DAC_LOW_TRIP, DAC_HIGH_TRIP. Must be used with EN_MAC_DAC = 1. CLKin_SELECT_MODE must be 4 or 6 (auto mode) to use.

	HOLD_DLD_CNT	In HOLDOVER mode, wait for this many clocks of PLL1 PDF within the tolerances of PLL1_WND_SIZE before exiting holdover mode.
	DAC_CLK_DIV	DAC update clock is the PLL1 phase detector divided by this divisor. For proper operation, DAC update clock rate should be ≤ 100 kHz. DAC update rate = PLL1 phase detector frequency / DAC_CLK_DIV
	EN_MAN_DAC	Enables manual DAC mode and set DAC voltage when in holdover.
	MAN_DAC	Sets the value for the DAC when EN_MAN_DAC is 1 and holdover is engaged. Readback from this register is the current DAC value whether in manual DAC mode or DAC tracking mode
	DAC_LOW_TRIP	Value from GND in ~ 50 mV steps at which a clock switch event is generated. If Holdover mode is enabled, it will be engaged upon the clock switch event. NOTE: EN_VTUNE_RAIL_DET must be enabled for this to be valid.
	DAC_HIGH_TRIP	Value from VCC (3.3V) in ~ 50 mV steps at which clock switch event is generated. If Holdover mode is enabled, it will be engaged upon the clock switch event. NOTE: EN_VTUNE_RAIL_DET must be enabled for this to be valid.
PLL1	PLL1_WND_SIZE	If the phase error between the PLL1 reference and feedback clocks is less than specified time, then the PLL1 lock counter increments. NOTE: Final lock detect valid signal is determined when the PLL1 lock counter meets or exceeds the PLL1_DLD_CNT value.
	PLL1_DLD_CNT	The reference and feedback of PLL1 must be within the window of phase error as specified by PLL1_WND_SIZE for this many cycles before PLL1 digital lock detect is asserted.
	CLKinX_PreR_DIV	The PreR dividers divide the CLKinX reference before the PLL1_R divider. Unique divides on individual CLKinX signals allows switchover from one clock input to another clock input without needing to reprogram the PLL1_R divider to keep the device in lock.

	PLL1_N_DLY	N delay causes clock outputs to lead clock input when in a 0-delay mode. Increasing the N delay value increases the output phase lead relative to the input.
	PLL1_R_DLY	R delay causes clock outputs to lag clock input when in a 0-delay mode. Increasing the R delay value increases the output phase lag relative to the input.
PLL2	PLL2_WND_SIZE	If the phase error between the PLL2 reference and feedback clock is less than specified time, then the PLL2 lock counter increments.
	PLL2_DLD_CNT	The reference and feedback of PLL2 must be within the window of phase error as specified by PLL2_WND_SIZE for this many cycles before PLL2 digital lock detect is asserted.
	EN_PLL2_REF_2X	Enables the doubler block to double the reference frequency into the PLL2 R counter. This can allow for frequency of 2/3, 2/5, etc. of OSCin to be used at the phase detector of PLL2.
	PLL2_N_CAL	The PLL2_N_CAL register contains the N value used for the VCO calibration routine. Except during 0-delay modes, the PLL2_N and PLL2_N_CAL registers will be exactly the same.
	PLL2_R3_LF	Set the corresponding integrated PLL2 loop filter values: R3, R4, C3, and C4.
	PLL2_R4_LF	
	PLL2_C3_LF	It is also possible to set these values by clicking on the loop filter values on the Clock Outputs tab.
	PLL2_C4_LF	
		PLL2_FAST_PDF
Program Pins	SYNC	Sets these pins on the uWire header to logic high (checked) or logic low (unchecked).
	Status_CLKin0	
	Status_CLKin1	

Registers Tab

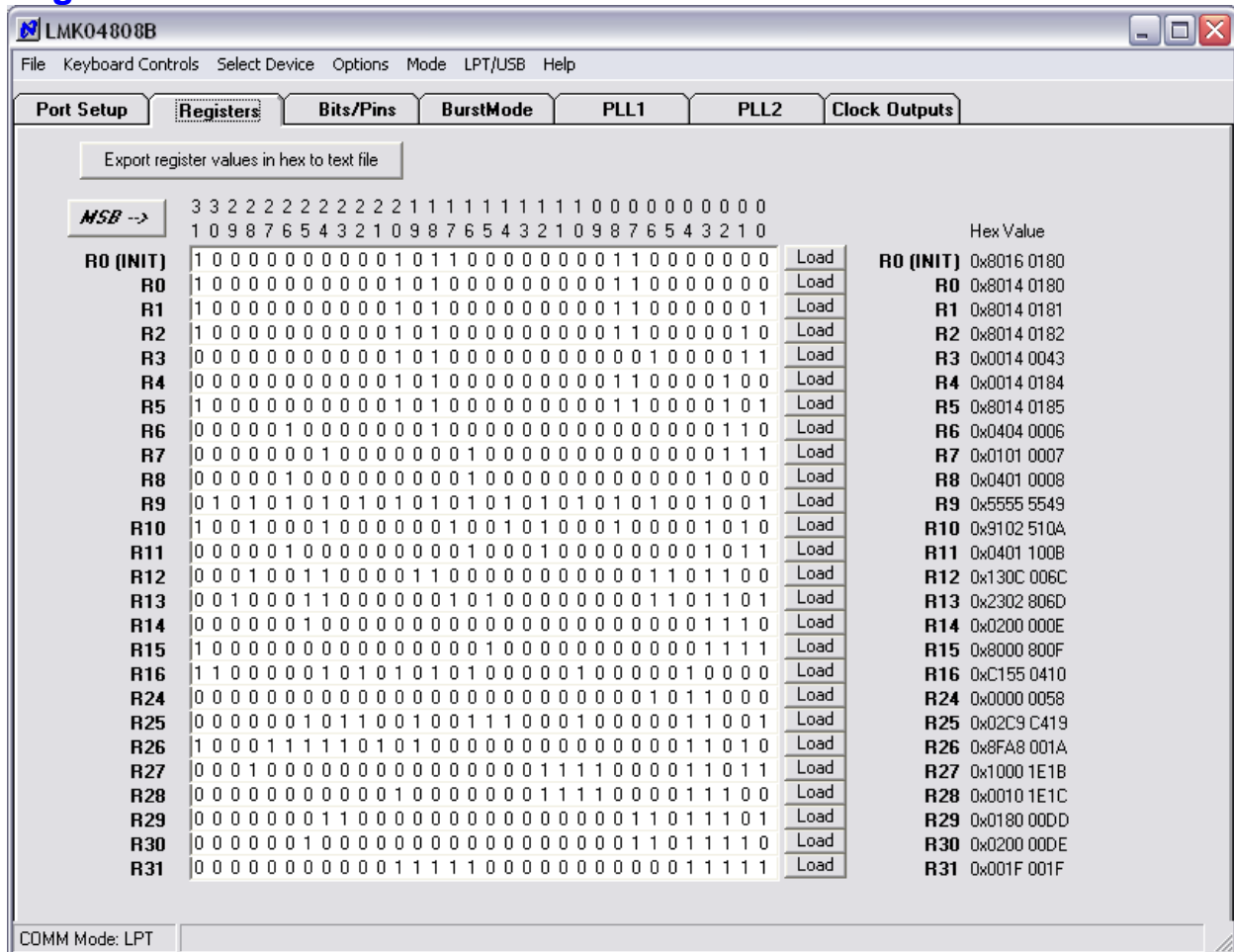

Figure 14: Registers Tab

The Registers tab shows the value of each register. This is convenient for programming the device to the desired settings, then exporting to a text file the register values in hexadecimal for use in your own application.

By clicking in the “bit field” it is possible to manually change the value of registers by typing ‘1’ and ‘0.’

Appendix B: Typical Phase Noise Performance Plots

PLL1

The LMK048xxB's dual PLL architecture achieves ultra low jitter and phase noise by allowing the external VCXO or Crystal's phase noise to dominate the final output phase noise at low offset frequencies and the internal VCO's phase noise to dominate the final output phase noise at high offset frequencies. This results in the best overall noise and jitter performance.

Table 11 lists the test conditions used for output clock phase noise measurements with the Crystek 122.88 MHz VCXO.

Table 11: LMK048xxB Test Conditions

Parameter	Value
PLL1 Reference clock input	CLKin0 single-ended input, CLKin0* AC-coupled to GND
PLL1 Reference Clock frequency	122.88 MHz
PLL1 Phase detector frequency	122.88 MHz
PLL1 Charge Pump Gain	100 uA
VCXO frequency	122.88 MHz
PLL2 phase detector frequency	122.88 MHz
PLL2 Charge Pump Gain	3200 uA
PLL2 REF2X mode	Disabled

122.88 MHz VCXO Phase Noise

The phase noise of the reference is masked by the phase noise of this VCXO by using a narrow loop bandwidth for PLL1 while retaining the frequency accuracy of the reference clock input. This VCXO sets the reference noise to PLL2. Figure 15 shows the open loop typical phase noise performance of the CVHD-950-122.88 Crystek VCXO.

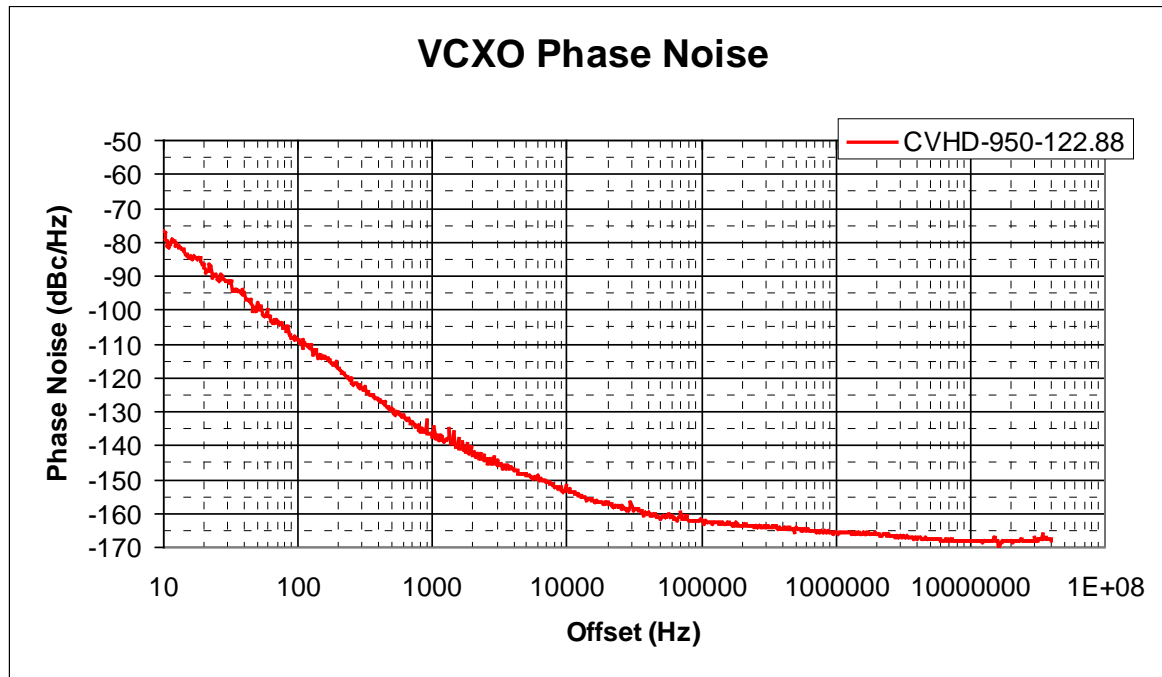

Figure 15: Crystek CVHD-950-122.88 MHz VCXO Phase Noise at 122.88 MHz

Table 12: VCXO Phase Noise at 122.88 MHz (dBc/Hz)

Offset	Phase Noise
10 Hz	-76.6
100 Hz	-108.9
1 kHz	-137.4
10 kHz	-153.3
100 kHz	-162.0
1 MHz	-165.7
10 MHz	-168.1
40 MHz	-168.1

Table 13: VCXO RMS Jitter to high offset of 20 MHz at 122.88 MHz (rms fs)

Low Offset	Jitter
10 Hz	515.4
100 Hz	60.5
1 kHz	36.2
10 kHz	35.0
100 kHz	34.5
1 MHz	32.9
10 MHz	22.7

Clock Output Measurement Technique

The same technique was used to measure phase noise for all three output types available on the programmable OSCout and CLKout buffers. This was achieved by terminating one side of the LVPECL, LVDS, or LVC MOS output with a 50-ohm load, and measuring the other side single-ended using an Agilent E5052B Source Signal Analyzer.

Buffered OSCout Phase Noise

Both OSCout0 and OSCout1 frequencies are 122.88 MHz since the OSCout Divider is bypassed. OSCout0 is programmed to LVC MOS mode and OSCout1 is fixed as LVPECL.

Clock Outputs (CLKout)

The LMK04800 Family features programmable LVDS, LVPECL, and LVCMOS buffer modes for the CLKoutX and OSCout0 output pairs. The OSCout1 output pair has a LVPECL buffer. Included below are various phase noise measurements for each output format.

LMK04808B CLKout Phase Noise

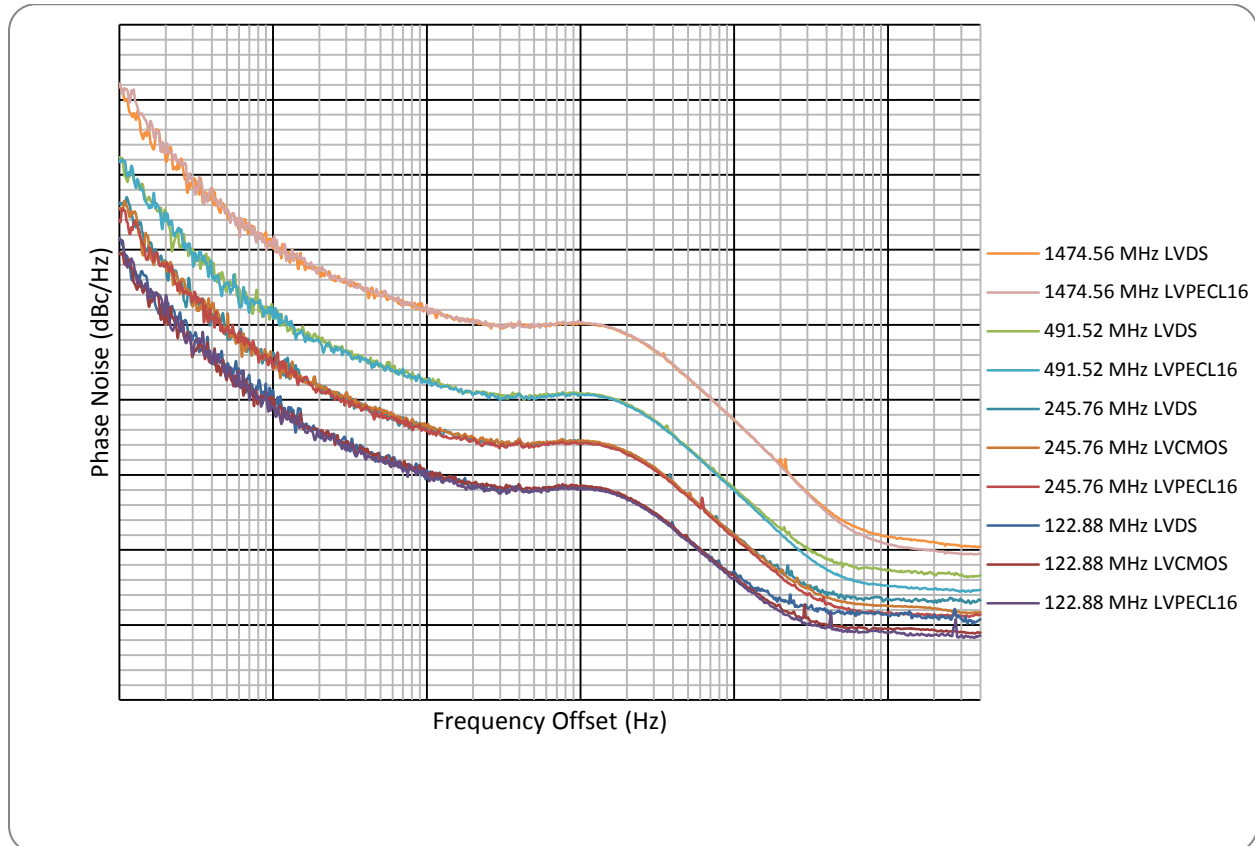

Figure 16: LMK04808B CLKout Phase Noise

Table 14: LMK04808B Phase Noise (dBc/Hz) Phase Noise and RMS Jitter (fs)

Offset	1474.56 MHz LVDS	1474.56 MHz LVPECL	491.52 MHz LVDS	491.52 MHz LVPECL
100 Hz	-88.2	-87.8	-97.7	-99.7
1 kHz	-109.8	-108.9	-118.9	-119.3
10 kHz	-118.0	-117.4	-127.3	-127.4
100 kHz	-119.8	-119.7	-129.1	-129.4
800 kHz	-130.9	-130.8	-140.1	-140.3
1 MHz	-132.7	-132.6	-141.7	-142.1
10 MHz	-148.2	-149.2	-152.7	-154.9
20 MHz	-148.9	-150.1	-153.2	-155.3
RMS Jitter (fs) 10 kHz to 20 MHz	99.3	99.4	109.1	103.3
RMS Jitter (fs) 100 Hz to 20 MHz	111.4	113.5	121.3	116.1

For the LMK04808B, the internal VCO frequency is 2949.12 MHz. The divide-by-12 CLKout frequency is 245.76 MHz, and the divide-by-24 CLKout frequency is 122.88 MHz.

Table 15: LMK04808B Phase Noise and RMS Jitter for Different CLKout Output Formats and Frequencies

Offset	245.76 LVDS	245.76 LVCMOS	245.76 LVPECL	122.88 LVDS	122.88 LVCMOS	122.88 LVPECL
100 Hz	-103.7	-104.4	-106.1	-108.4	-110.4	-108.5
1 kHz	-123.7	-125.9	-125.7	-128.7	-129.7	-130.9
10 kHz	-133.8	-133.5	-134.0	-139.3	-139.8	-140.0
100 kHz	-135.5	-135.4	-135.8	-141.7	-141.4	-141.8
800 kHz	-146.4	-146.3	-146.7	-151.7	-152.1	-152.4
1 MHz	-147.9	-148.0	-148.3	-152.9	-153.4	-153.8
10 MHz	-156.5	-157.5	-158.3	-158.7	-160.5	-161.0
20 MHz	-156.9	-157.8	-158.6	-158.8	-160.7	-161.3
RMS Jitter (fs) 10 kHz to 20 MHz	111.8	109.6	103.9	133.4	122.1	116.1
RMS Jitter (fs) 100 Hz to 20 MHz	124.3	122.1	115.4	144.4	132.3	127.9

LMK04808B OSCout Phase Noise

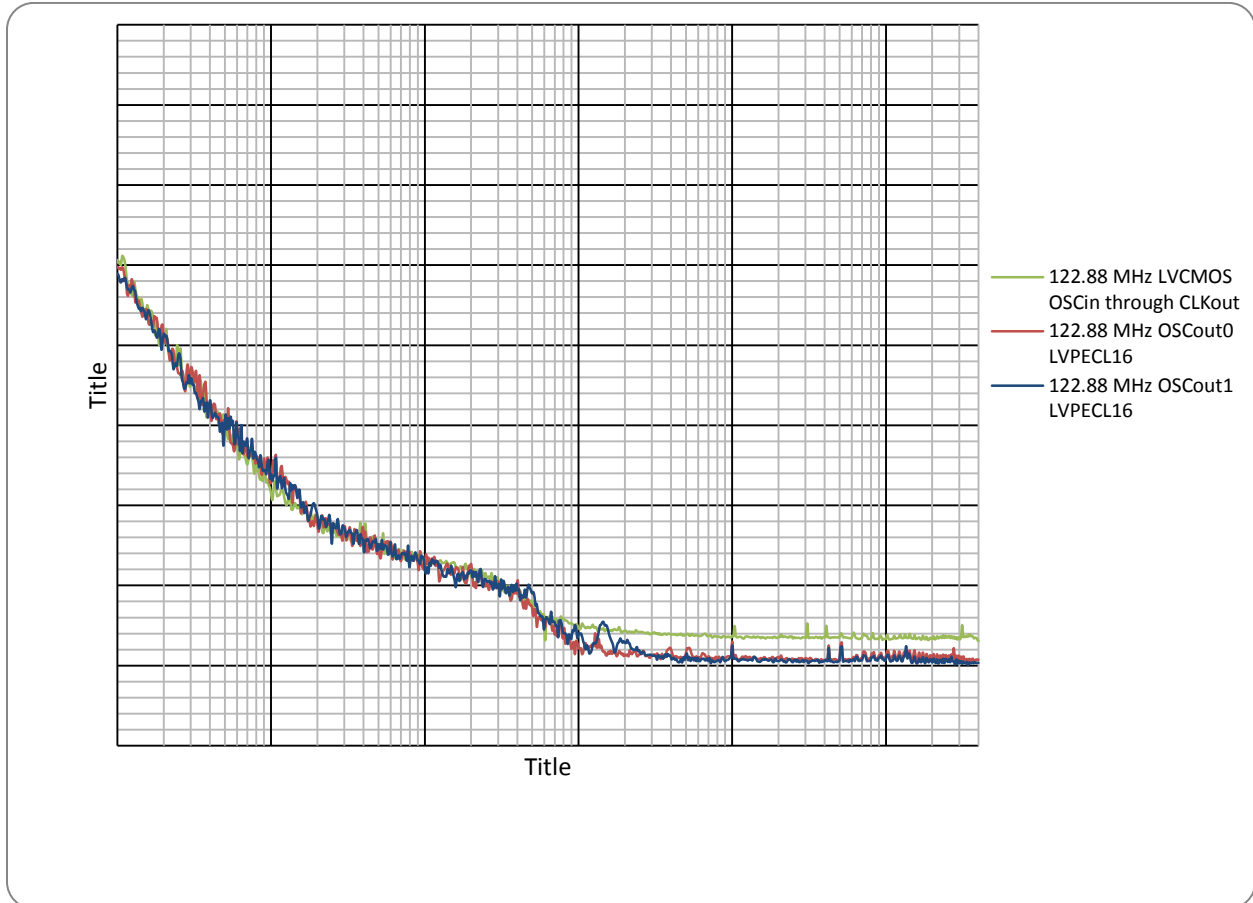

Figure 17: LMK04808B OSCout Phase Noise

Table 16: LMK04808B OSCout Phase Noise and RMS Jitter (fs)

Offset	OSCout0 LVPECL	OSCout1 LVPECL	OSCin thru CLKout
100 Hz	-110.2	-111.1	-109.4
1 kHz	-137.2	-136.1	-138.6
10 kHz	-148.0	-148.0	-146.7
100 kHz	-157.8	-156.0	-155.3
800 kHz	-159.1	-159.4	-156.4
1 MHz	-157.0	-157.5	-156.3
10 MHz	-158.8	-159.2	-156.7
20 MHz	-159.2	-159.5	-156.7
RMS Jitter (fs) 10 kHz to 20 MHz	94.1	91.0	123.7
RMS Jitter (fs) 100 Hz to 20 MHz	103.2	99.6	131.3

LMK04806B CLKout Phase Noise

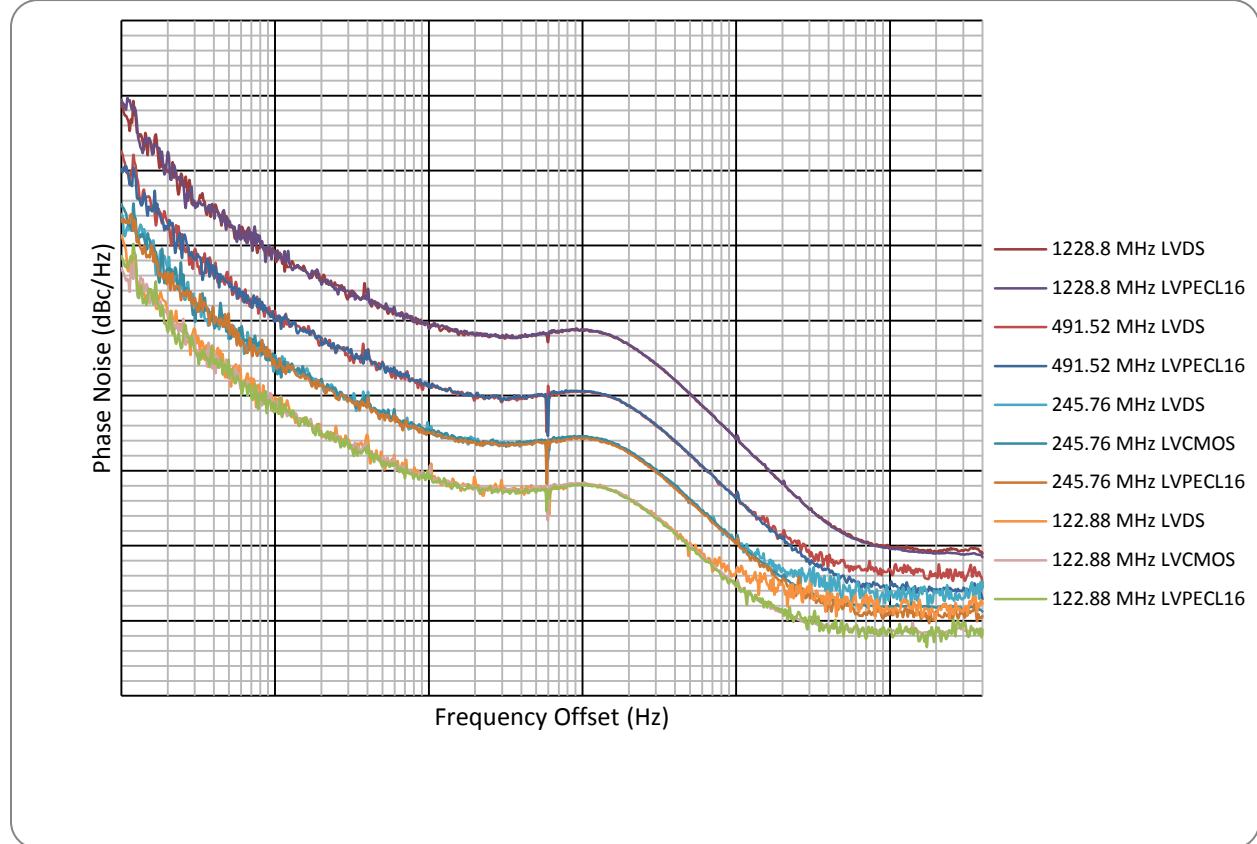

Figure 18: LMK04806B CLKout Phase Noise

Table 17: LMK04806B Phase Noise (dBc/Hz) Phase Noise and RMS Jitter (fs)

Offset	1228.80 MHz LVDS	1228.80 MHz LVPECL	491.52 MHz LVDS	491.52 MHz LVPECL
100 Hz	-91.2	-90.5	-97.5	-98.2
1 kHz	-111.2	-110.8	-118.7	-119.4
10 kHz	-121.0	-121.1	-128.5	-128.6
100 kHz	-121.3	-121.2	-129.5	-129.5
800 kHz	-133.8	-133.7	-141.9	-141.9
1 MHz	-135.8	-135.7	-143.4	-143.8
10 MHz	-150.2	-150.4	-153.1	-155.7
20 MHz	-150.8	-151.0	-153.8	-155.7
RMS Jitter (fs) 10 kHz to 20 MHz	92.9	93.4	97.5	94.5
RMS Jitter (fs) 100 Hz to 20 MHz	104.0	105.3	109.0	105.4

For the LMK04806B, the internal VCO frequency is 2457.60 MHz. The divide-by-10 CLKout frequency is 245.76 MHz, and the divide-by-20 CLKout frequency is 122.88 MHz.

Table 18: LMK04806B Phase Noise and RMS Jitter for Different CLKout Output Formats and Frequencies

Offset	245.76 LVDS	245.76 LVCMOS	245.76 LVPECL	122.88 LVDS	122.88 LVCMOS	122.88 LVPECL
100 Hz	-105.8	-104.5	-106.5	-108.6	-113.0	-111.4
1 kHz	-124.7	-124.9	-125.4	-130.2	-132.1	-131.0
10 kHz	-134.8	-134.4	-134.9	-140.7	-140.7	-141.0
100 kHz	-135.5	-135.4	-135.8	-141.7	-141.7	-141.9
800 kHz	-147.8	-147.7	-148.0	-152.6	-153.5	-154.1
1 MHz	-149.6	-149.4	-149.7	-153.3	-155.2	-155.5
10 MHz	-156.1	-158.1	-158.4	-158.4	-161.5	-161.1
20 MHz	-156.3	-158.2	-158.9	-159.5	-161.6	-161.3
RMS Jitter (fs) 10 kHz to 20 MHz	106.9	101.5	96.4	134.2	109.7	108.2
RMS Jitter (fs) 100 Hz to 20 MHz	116.8	112.4	106.4	143.2	118.9	117.9

LMK04806B OSCout Phase Noise

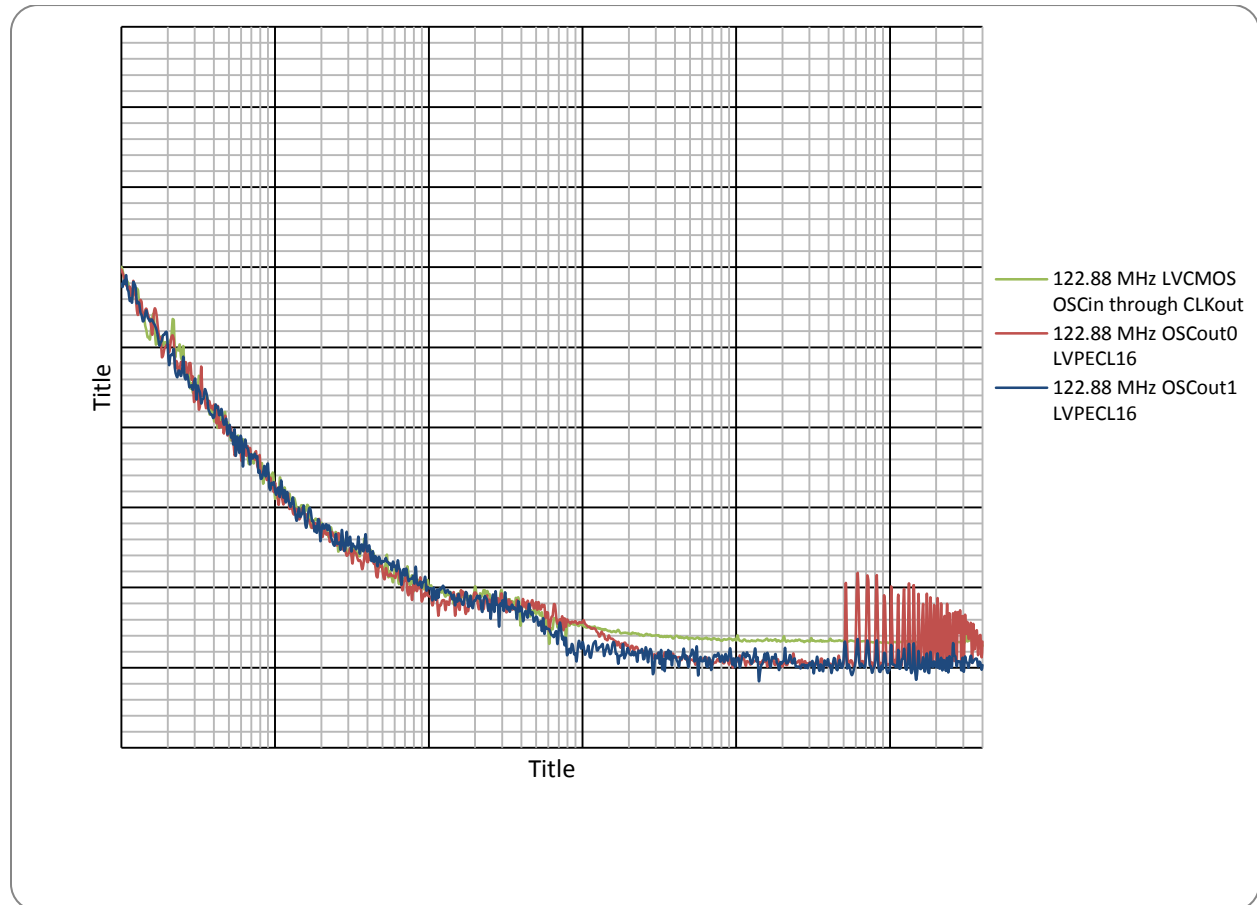

Figure 19: LMK04806B OSCout Phase Noise

Table 19: LMK04806B OSCout Phase Noise and RMS Jitter (fs)

Offset	OSCout0 LVPECL	OSCout1 LVPECL	OSCin thru CLKout
100 Hz	-110.3	-112.1	-110.0
1 kHz	-136.9	-137.9	-138.9
10 kHz	-151.1	-150.1	-150.0
100 kHz	-154.3	-156.8	-154.6
800 kHz	-158.9	-158.9	-156.6
1 MHz	-159.2	-159.1	-156.6
10 MHz	-159.4	-160.0	-156.8
20 MHz	-157.6	-159.9	-156.9
RMS Jitter (fs) 10 kHz to 20 MHz	138.4	89.7	120.0
RMS Jitter (fs) 100 Hz to 20 MHz	143.7	97.3	126.2

LMK04803B CLKout Phase Noise

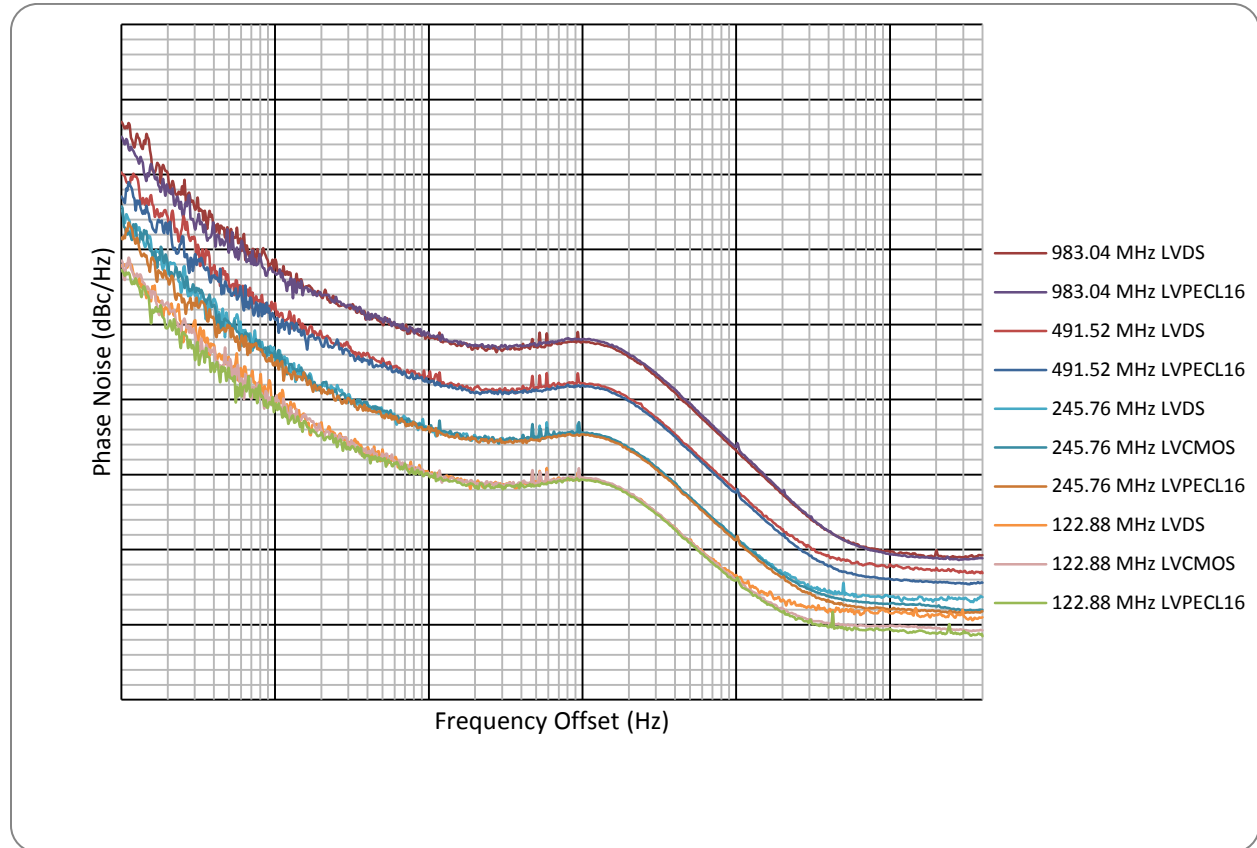

Figure 20: LMK04803B CLKout Phase Noise

Table 20: LMK04803B Phase Noise (dBc/Hz) Phase Noise and RMS Jitter (fs)

Offset	983.04 MHz LVDS	983.04 MHz LVPECL	491.52 MHz LVDS	491.52 MHz LVPECL
100 Hz	-93.0	-95.0	-99.7	-99.5
1 kHz	-111.3	-113.1	-117.1	-118.3
10 kHz	-121.8	-121.1	-126.9	-127.4
100 kHz	-122.3	-121.9	-127.8	-128.3
800 kHz	-134.9	-134.5	-140.3	-140.8
1 MHz	-136.8	-136.3	-142.0	-142.7
10 MHz	-150.3	-150.6	-152.0	-154.2
20 MHz	-150.4	-151.1	-152.6	-154.6
RMS Jitter (fs) 10 kHz to 20 MHz	103.8	107.4	116.0	108.1
RMS Jitter (fs) 100 Hz to 20 MHz	116.1	116.2	127.4	116.8

For the LMK04803B, the internal VCO frequency is 1966.08 MHz. The divide-by-8 CLKout frequency is 245.76 MHz, and the divide-by-16 CLKout frequency is 122.88 MHz.

Table 21: LMK04803B Phase Noise and RMS Jitter for Different CLKout Output Formats and Frequencies

Offset	245.76 LVDS	245.76 LVCMOS	245.76 LVPECL	122.88 LVDS	122.88 LVCMOS	122.88 LVPECL
100 Hz	-104.8	-104.2	-108.4	-112.1	-111.5	-112.7
1 kHz	-124.8	-123.5	-125.0	-130.5	-130.2	-130.6
10 kHz	-133.7	-134.0	-133.6	-140.1	-139.8	-140.1
100 kHz	-134.4	-134.4	-134.6	-140.6	-140.4	-140.7
800 kHz	-146.7	-146.7	-147.1	-152.5	-152.4	-152.7
1 MHz	-148.5	-148.5	-148.7	-153.4	-154.0	-154.0
10 MHz	-156.2	-157.2	-158.0	-158.4	-160.1	-160.5
20 MHz	-156.6	-157.5	-158.2	-158.7	-160.4	-161.1
RMS Jitter (fs) 10 kHz to 20 MHz	115.1	113.1	107.9	137.5	126.1	120.5
RMS Jitter (fs) 100 Hz to 20 MHz	126.4	124.2	116.7	147.5	136.4	128.9

LMK04803B OSCout Phase Noise

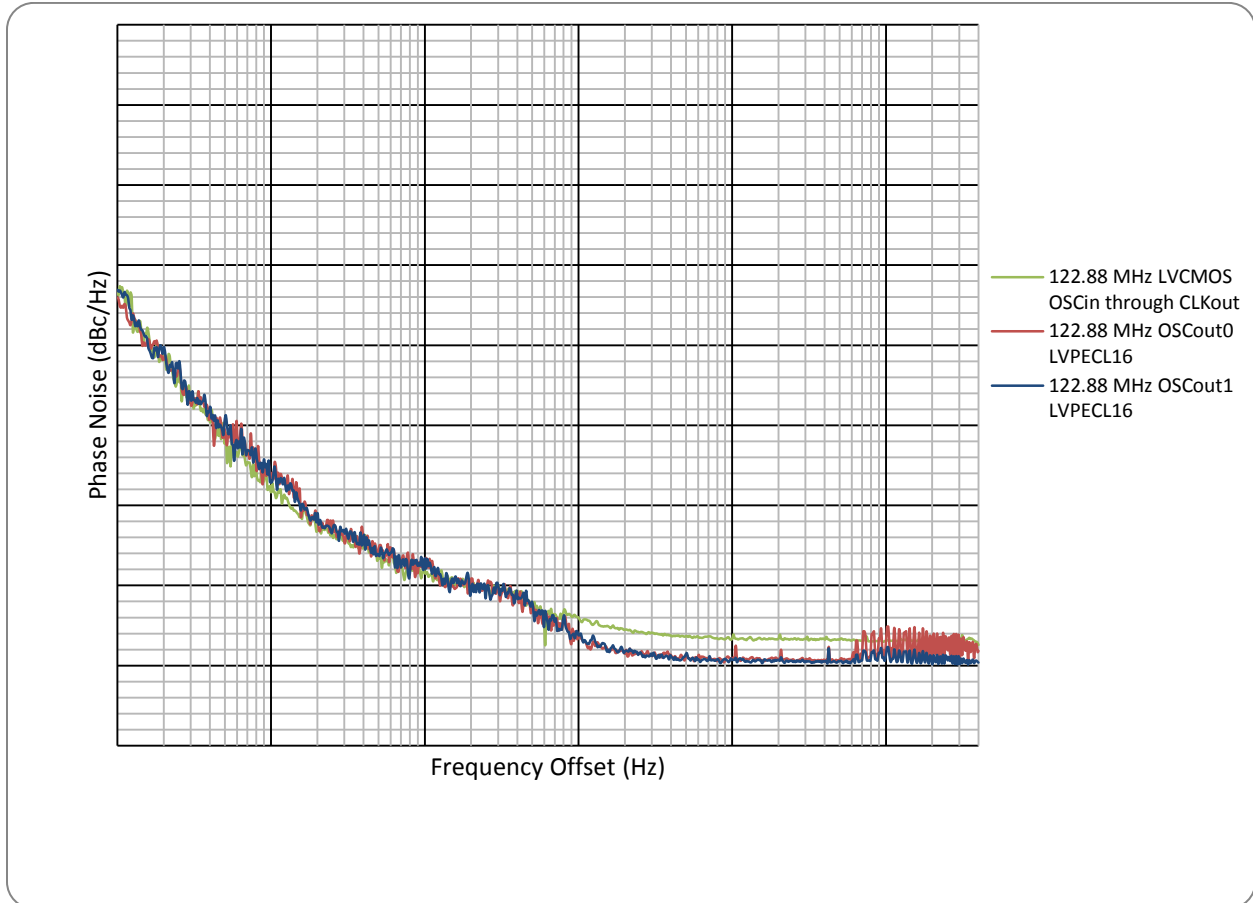

Figure 21: LMK04803B OSCout Phase Noise

Table 22: LMK04803B OSCout Phase Noise and RMS Jitter (fs)

Offset	OSCout0 LVPECL	OSCout1 LVPECL	OSCin thru CLKout
100 Hz	-114.0	-113.1	-113.3
1 kHz	-136.6	-137.2	-138.4
10 kHz	-147.6	-146.6	-148.5
100 kHz	-156.3	-156.2	-154.0
800 kHz	-159.4	-159.2	-156.6
1 MHz	-159.0	-159.3	-156.7
10 MHz	-157.2	-158.7	-156.9
20 MHz	-158.1	-159.4	-157.0
RMS Jitter (fs) 10 kHz to 20 MHz	107.1	92.4	119.1
RMS Jitter (fs) 100 Hz to 20 MHz	111.6	98.1	123.3

Appendix C: Schematics

Power Supplies

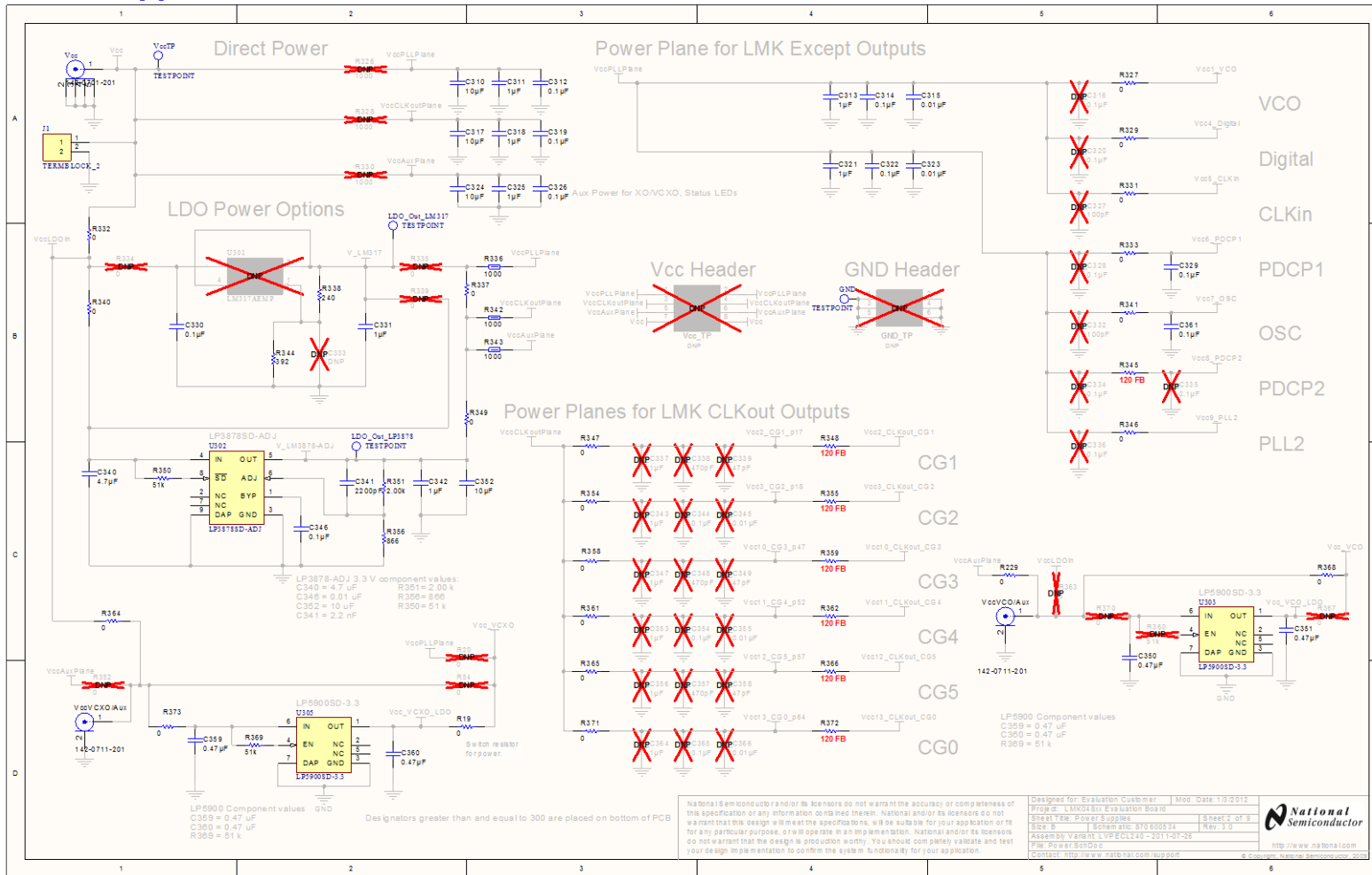

LMK048xxB Device with Loop Filter and Crystal Circuits

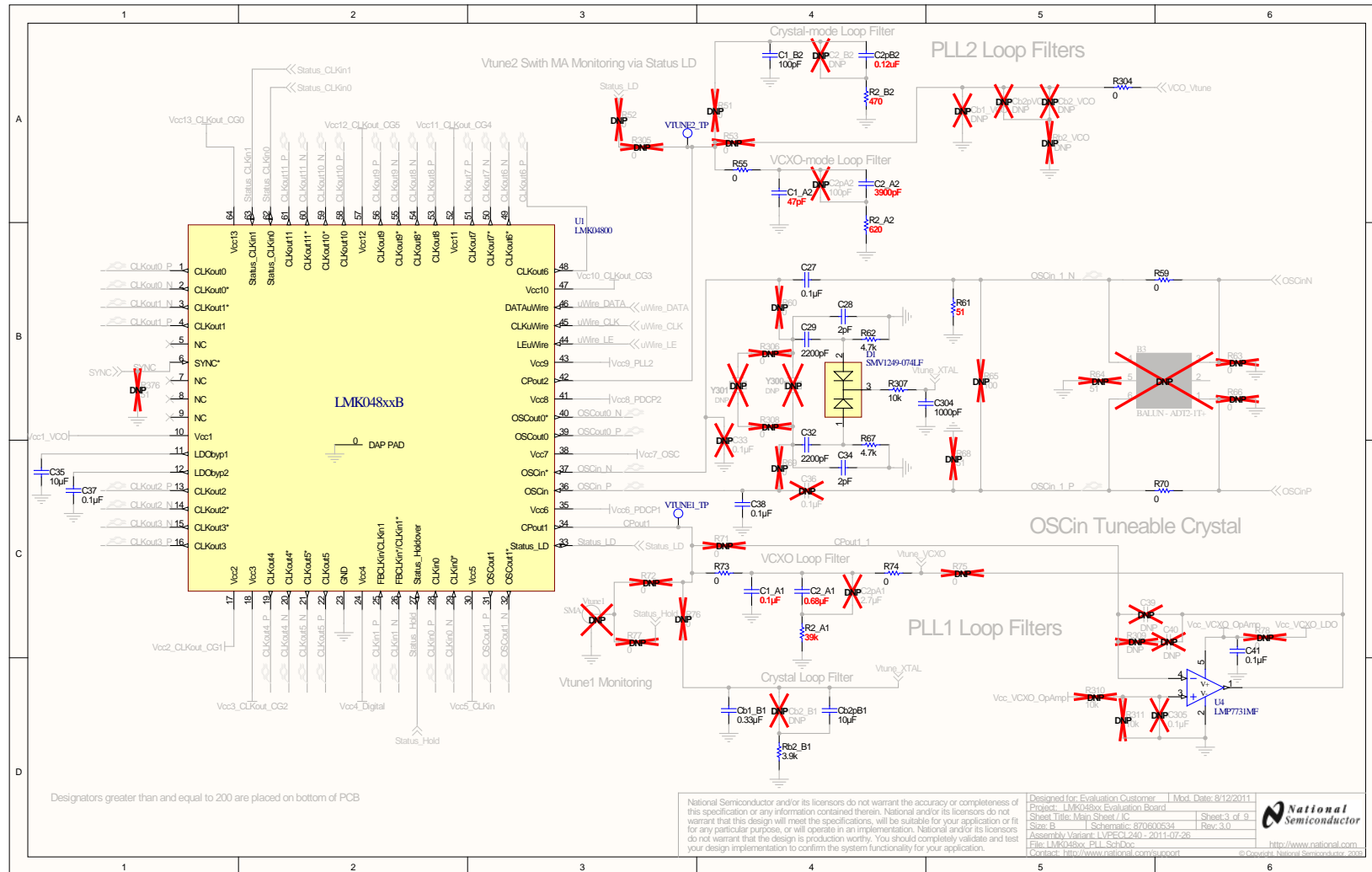

Reference Inputs (CLKin0 & CLKin1), External VCXO (OSCin) & VCO Circuits, and OSCout1 Output

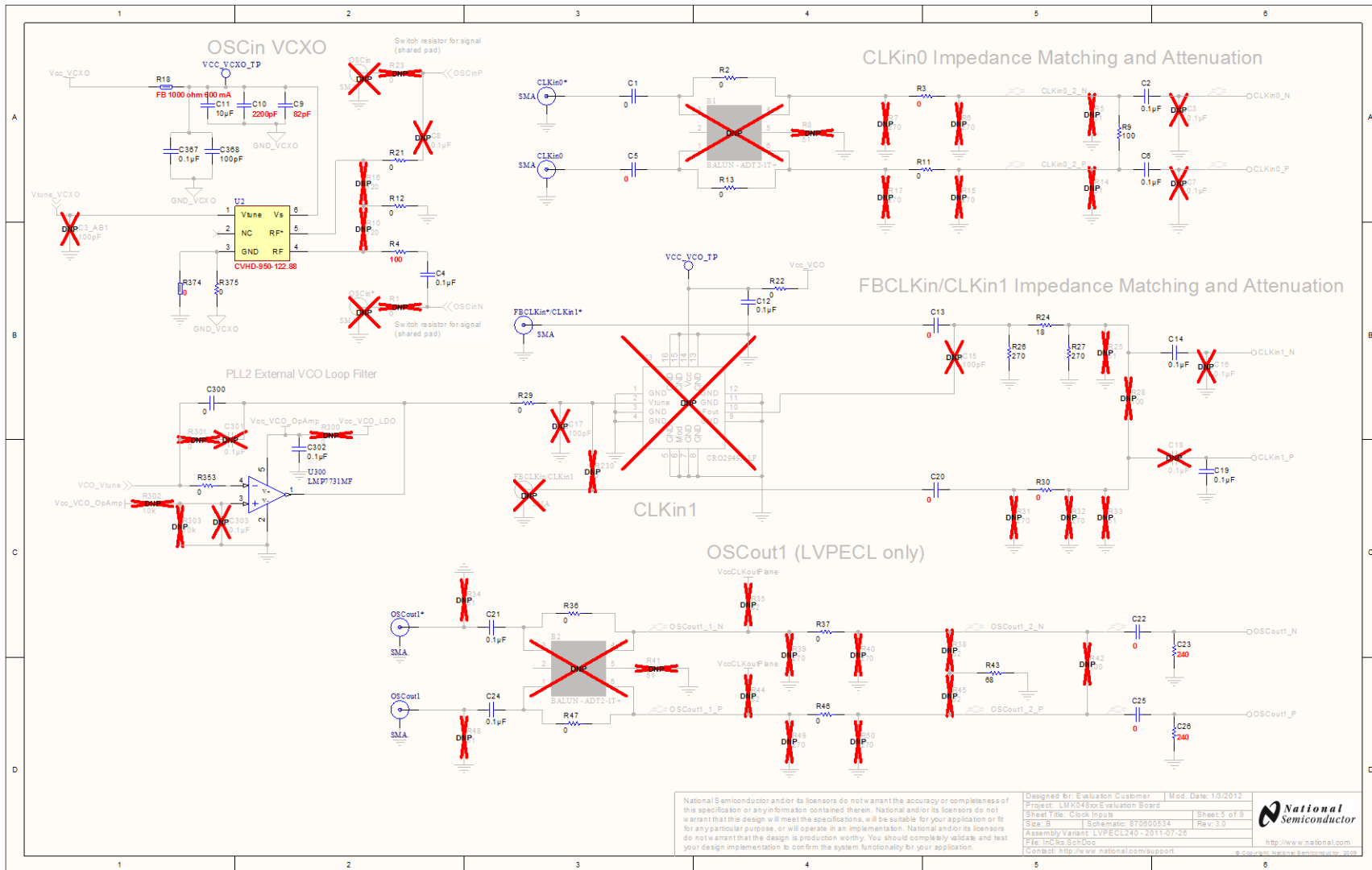

Clock Outputs (OSCout0, CLKout0 to CLKout3)

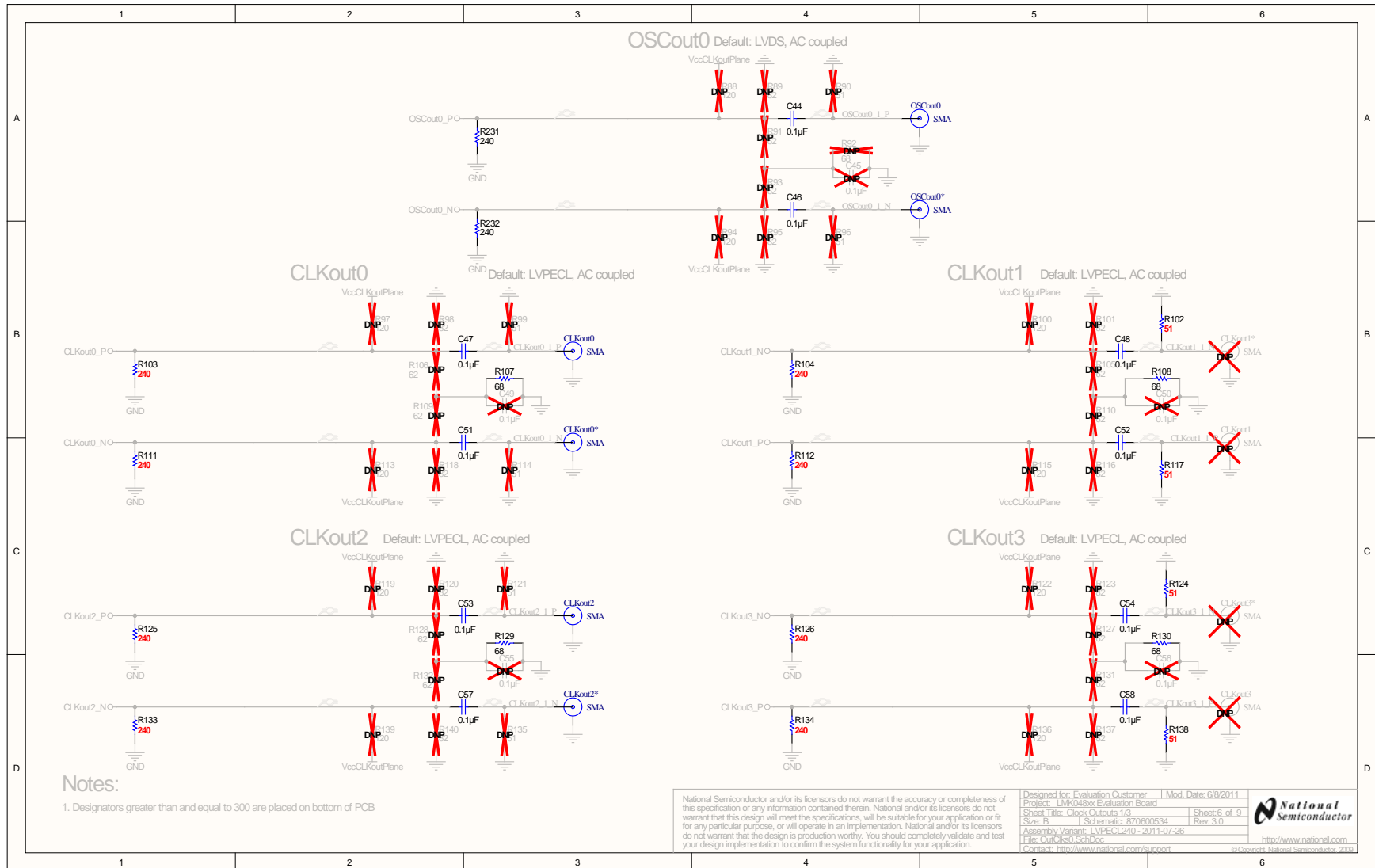

Clock Outputs (CLKout4 to CLKout7)

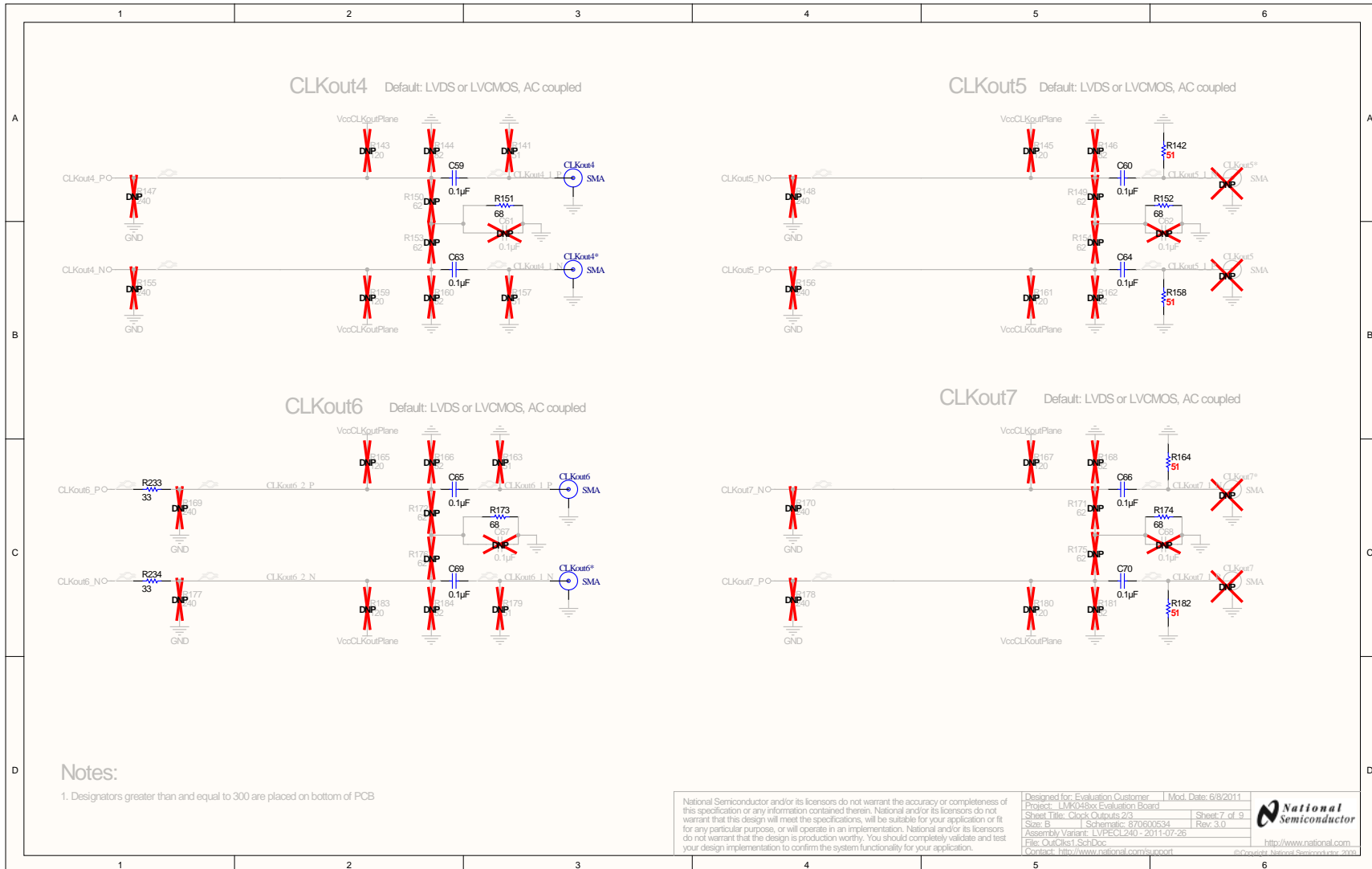

Clock Outputs (CLKout8 to CLKout11)

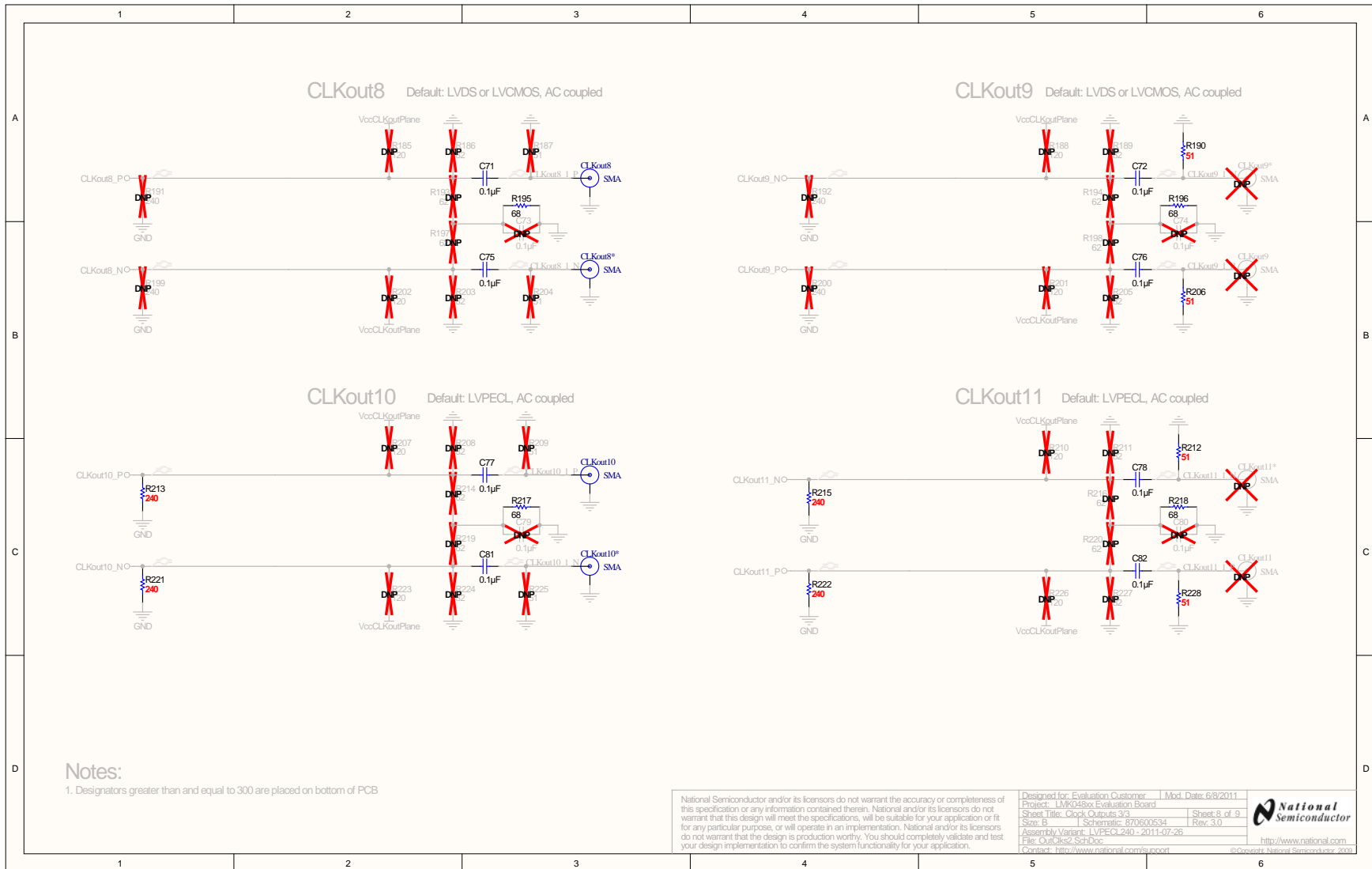

uWire Header, Logic I/O Ports and Status LEDs

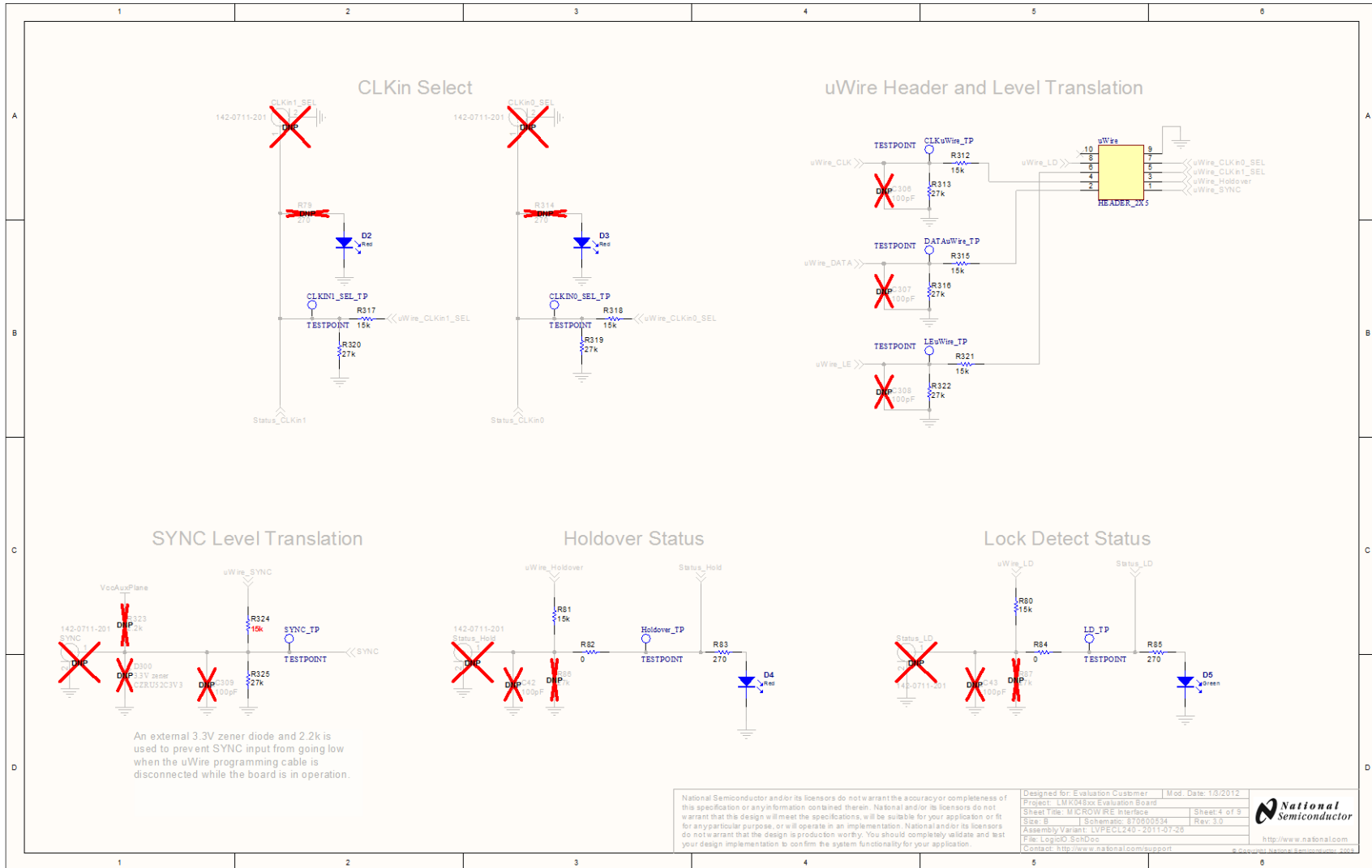

USB Interface

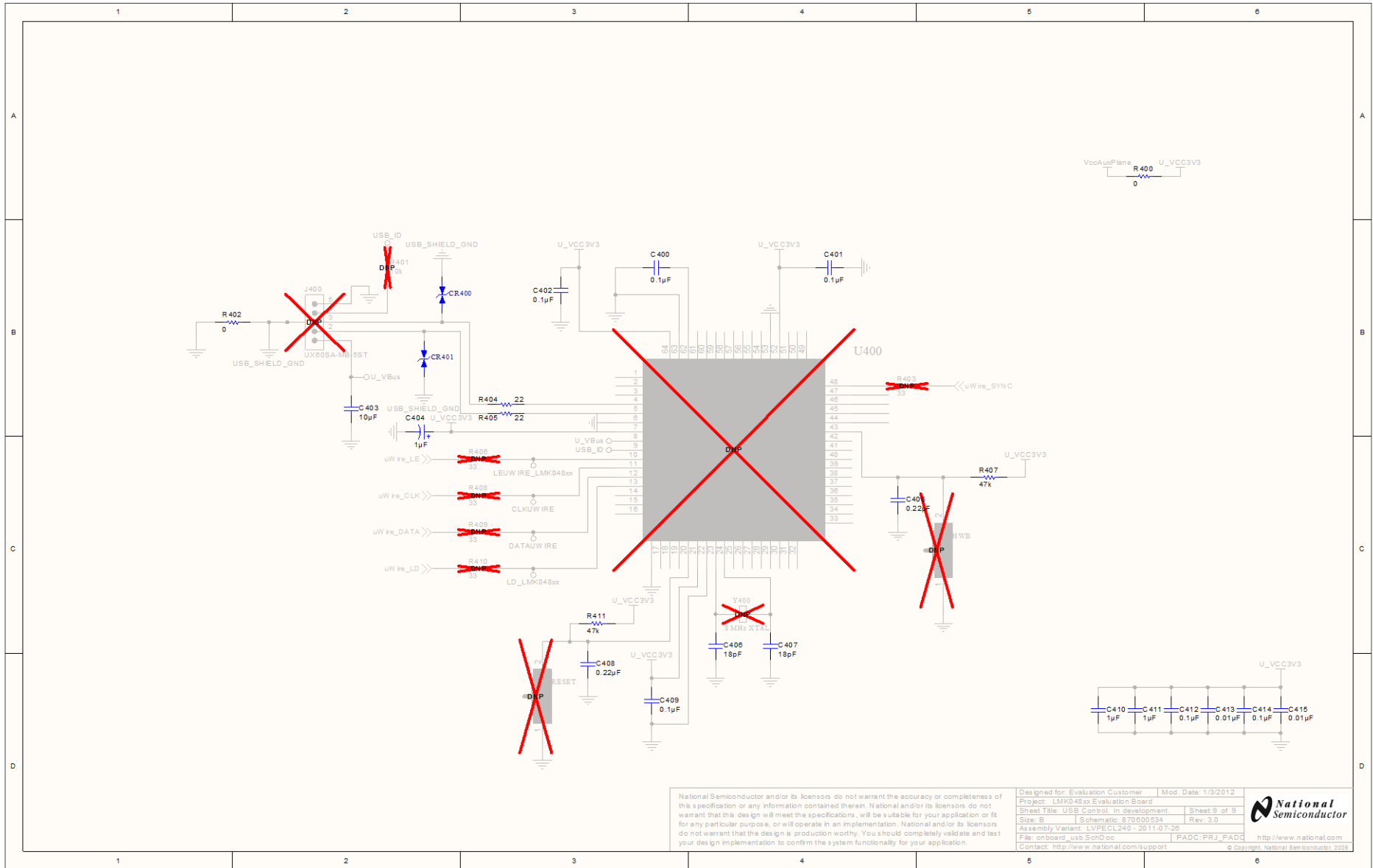

Appendix D: Bill of Materials

Table 23: Bill of Materials for LMK048xx Evaluation Boards

Item	Designator	Description	Manufacturer	PartNumber	Quantity
1	C1, C5, C13, C20, C22, C25, C300, R3, R11, R12, R19, R21, R22, R29, R30, R37, R46, R55, R73, R74, R82, R84, R229, R304, R327, R329, R331, R333, R337, R340, R341, R346, R347, R349, R353, R354, R358, R361, R364, R365, R368, R371, R373, R374, R375, R400, R402	FB, 120 ohm, 500 mA, 0603, RES, 0 ohm, 5%, 0.1W, 0603	Vishay-Dale, Vishey/Dale	CRCW06030000Z0EA	47

2	C1_A1, C6, C14, C19, C21, C24, C27, C37, C38, C44, C46, C47, C48, C51, C52, C53, C54, C57, C58, C59, C60, C63, C64, C65, C66, C70, C71, C72, C75, C76, C77, C78, C81, C82, C312, C319, C329, C361	CAP, CERM, 0.1uF, 25V, +/-5%, X7R, 0603	Kemet	C0603C104J3RACTU	38
3	C1_A2	CAP, CERM, 47pF, 50V, +/-5%, C0G/NP0, 0603	Kemet	C0603C470J5GACTU	1
4	C1_B2	CAP, CERM, 150pF, 50V, +/-5%, C0G/NP0, 0603	Kemet	C0603C151J5GACTU	1
5	C2, C12, C41, C302, C330, C346	CAP, CERM, 0.1uF, 16V, +/-10%, X7R, 0603	Kemet	C0603C104K4RACTU	6
6	C2pB2	CAP, CERM, 0.12uF, 50V, +/-10%, X7R, 0805	Kemet	C0805C124K5RACTU	1
7	C2_A1	CAP, CERM, 0.68uF, 10V, +/-10%, X5R, 0603	Kemet	C0603C684K8PAC	1
8	C2_A2	CAP, CERM, 3900pF, 50V, +/-10%, X7R, 0603	MuRata	GRM188R71H392KA01D	1
9	C4, C69, C314, C322, C326, C367, C400, C401, C402, C409, C412, C414	CAP, CERM, 0.1uF, 25V, +/-10%, X7R, 0603, CAP, CERM, 0.1uF, 25V, +/-10%, X7R, 0603	Kemet	C0603C104K3RACTU	12
10	C9	CAP, CERM, 82pF, 50V, +/-10%, C0G/NP0, 0603	Kemet	C0603C820K5GACTU	1
11	C10, C29, C32, C341	CAP, CERM, 2200pF, 50V, +/-10%, X7R, 0603	Kemet	C0603C222K5RACTU	4
12	C11	CAP, CERM, 10uF, 10V, +/-20%, X5R, 0805	Kemet	C0805C106M8PACTU	1

13	C23, C26, R103, R104, R111, R112, R125, R126, R133, R134, R213, R215, R221, R222, R231, R232, R338	RES, 240 ohm, 5%, 0.1W, 0603	Vishay-Dale	CRCW0603240RJNEA	17
14	C28, C34	CAP, CERM, 2pF, 50V, +/-12.5%, C0G/NP0, 0603	Kemet	C0603C209C5GACTU	2
15	C35, C310, C317, C324, C352, Cb2pB1	CAP, CERM, 10uF, 10V, +/-10%, X5R, 0805	Kemet	C0805C106K8PACTU	6
16	C304	CAP, CERM, 1000pF, 50V, +/-5%, C0G/NP0, 0603	Kemet	C0603C102J5GACTU	1
17	C311, C313, C318, C321, C325, C331, C342	CAP, CERM, 1uF, 10V, +/-10%, X5R, 0603	Kemet	C0603C105K8PACTU	7
18	C315, C323	CAP, CERM, 0.01uF, 100V, +/-10%, X7R, 0603	Kemet	C0603C103K1RACTU	2
19	C340	CAP, CERM, 4.7uF, 10V, +/-10%, X5R, 0603	Kemet	C0603C475K8PACTU	1
20	C350, C351, C359, C360	CAP, CERM, 0.47uF, 16V, +/-10%, X7R, 0603	Kemet	C0603C474K4RACTU	4
21	C368	CAP, CERM, 100pF, 50V, +/-5%, C0G/NP0, 0603	Kemet	C0603C101J5GACTU	1
22	C403	CAP, CERM, 10uF, 6.3V, +/-10%, X5R, 0805	Kemet	C0805C106K9PAC	1
23	C404	CAP, TANT, 1uF, 20V, +/-10%, 8.4 ohm, 3216-18 SMD	Vishay-Sprague	293D105X9020A2TE3	1
24	C405, C408	CAP, CERM, 0.22uF, 16V, +/-10%, X7R, 0603	Kemet	C0603C224K4RACTU	2
25	C406, C407	CAP, CERM, 18pF, 50V, +/-5%, C0G/NP0, 0603	Kemet	C0603C180J5GACTU	2
26	C410, C411	CAP, CERM, 1uF, 16V, +/-10%, X5R, 0603	Kemet	C0603C105K4PACTU	2
27	C413, C415	CAP, CERM, 0.01uF, 50V, +/-5%, X7R, 0603	Kemet	C0603C103J5RACTU	2
28	Cb1_B1	CAP, CERM, 0.33uF, 16V, +/-10%, X7R, 0603	Kemet	C0603C334K4RACTU	1

29	CLKin0, CLKin0*, CLKout0, CLKout0*, CLKout2, CLKout2*, CLKout4, CLKout4*, CLKout6, CLKout6*, CLKout8, CLKout8*, CLKout10, CLKout10*, FBCLKin*/CLKin1*, OScout0, OScout0*, OScout1, OScout1*	Connector, SMT, End launch SMA 50 Ohm	Emerson Network Power	142-0701-851	19
30	CR400, CR401	ESD suppressor	Littelfuse Inc	PGB1010603MR	2
31	D1	Common Cathode Tuning Varactor	Skyworks	SMV1249-074LF	1
32	D2, D3, D4	LED 2.8X3.2MM 565NM RED CLR SMD	Lumex Opto/Components Inc.	SML-LX2832IC	3
33	D5	LED 2.8X3.2MM 565NM GRN CLR SMD	Lumex Opto/Components Inc.	SML-LX2832GC	1
34	J1	CONN TERM BLK PCB 5.08MM 2POS OR	Weidmuller	1594540000	1
35	R2, R13, R36, R47, R59, R70, R332	RES, 0 ohm, 5%, 0.125W, 0805	Vishay-Dale	CRCW08050000Z0EA	7
36	R2_A1	RES, 39k ohm, 5%, 0.1W, 0603	Vishay-Dale	CRCW060339K0JNEA	1
37	R2_A2	RES, 620 ohm, 5%, 0.1W, 0603	Vishay-Dale	CRCW0603620RJNEA	1
38	R2_B2	RES, 470 ohm, 5%, 0.1W, 0603	Vishay-Dale	CRCW0603470RJNEA	1
39	R4, R9	RES, 100 ohm, 5%, 0.1W, 0603	Vishay-Dale	CRCW0603100RJNEA	2
40	R18, R336, R342, R343	FB, 1000 ohm, 600 mA, 0603, Ferrite	Murata	BLM18HE102SN1D	4
41	R24	RES, 18 ohm, 5%, 0.1W, 0603	Vishay-Dale	CRCW060318R0JNEA	1

42	R26, R27, R83, R85	RES, 270 ohm, 5%, 0.1W, 0603	Vishay-Dale	CRCW0603270RJNEA	4
43	R43, R107, R108, R129, R130, R151, R152, R173, R174, R195, R196, R217, R218	RES, 68 ohm, 5%, 0.1W, 0603	Vishay-Dale	CRCW060368R0JNEA	13
44	R61, R102, R117, R124, R138, R142, R158, R164, R182, R190, R206, R212, R228	RES, 51 ohm, 5%, 0.1W, 0603	Vishay-Dale	CRCW060351R0JNEA	13
45	R62, R67	RES, 4.7k ohm, 5%, 0.1W, 0603	Vishay-Dale	CRCW06034K70JNEA	2
46	R80, R81, R312, R315, R317, R318, R321, R324	RES, 15k ohm, 5%, 0.1W, 0603	Vishay-Dale	CRCW060315K0JNEA	8
47	R233, R234	RES, 33 ohm, 5%, 0.1W, 0603	Vishay-Dale	CRCW060333R0JNEA	2
48	R307	RES, 10k ohm, 5%, 0.1W, 0603	Vishay-Dale	CRCW060310K0JNEA	1
49	R313, R316, R319, R320, R322, R325	RES, 27k ohm, 5%, 0.1W, 0603	Vishay-Dale	CRCW060327K0JNEA	6
50	R344	RES, 392 ohm, 1%, 0.1W, 0603	Vishay-Dale	CRCW0603392RFKEA	1
51	R345, R348, R355, R359, R362, R366, R372	FB, 120 ohm, 500 mA, 0603	Murata	BLM18AG121SN1D	7
52	R350, R369	RES, 51k ohm, 5%, 0.1W, 0603	Vishay-Dale	CRCW060351K0JNEA	2
53	R351	RES, 2.00k ohm, 1%, 0.1W, 0603	Vishay-Dale	CRCW06032K00FKEA	1
54	R356	RES, 866 ohm, 1%, 0.1W, 0603	Vishay-Dale	CRCW0603866RFKEA	1
55	R404, R405	RES, 22 ohm, 5%, 0.125W, 0805	Vishay-Dale	CRCW080522R0JNEA	2
56	R407, R411	RES, 47k ohm, 5%, 0.1W, 0603	Vishay-Dale	CRCW060347K0JNEA	2
57	Rb2_B1	RES, 3.9k ohm, 5%, 0.1W, 0603	Vishay-Dale	CRCW06033K90JNEA	1
58	S1, S2, S3, S4, S5, S6	0.875" Standoff	VOLTRIX	SPCS-14	6
59	U1	LMK04800	Texas Instruments	LMK048xxBISQ	1

60	U2	122.88 MHz VCXO	Crystek	CVHD-950-122.88	1
61	U4, U300	Precision Single Low Noise, Low 1/F corner Op Amp	Texas Instruments	LMP7731MF	2
62	U302	Micropower 800mA Low Noise 'Ceramic Stable' Adjustable Voltage Regulator for 1V to 5V Applications	Texas Instruments	LP3878SD-ADJ	1
63	U303, U305	Ultra Low Noise, 150mA Linear Regulator for RF/Analog Circuits Requires No Bypass Capacitor	Texas Instruments	LP5900SD-3.3	2
64	uWire	Low Profile Vertical Header 2x5 0.100"	FCI	52601-G10-8LF	1
65	Vcc	Connector, TH, SMA	Emerson Network Power	142-0701-201	1
66	VccVCO/Aux, VccVCXO/Aux	Connector, SMA Jack, Vertical, Gold, SMD	Emerson Network Power Connectivity	142-0711-201	2
<u>Unpopulated Components</u>					
67	B1, B2, B3	ADT2-1T Balun	MiniCircuits	ADT2-1T+	0
68	C2pA1	CAP, CERM, 2.7uF, 10V, +/-10%, X5R, 0805	Kemet	C0805C275K8PACTU	0
69	C2pA2, C3_AB1, C15, C17, C42, C43, C306, C307, C308, C309	CAP, CERM, 100pF, 50V, +/-5%, C0G/NP0, 0603	Kemet	C0603C101J5GACTU	0
70	C2_B2	CAP, CERM, 6800pF, 100V, +/-10%, X7R, 0603	Kemet	C0603C682K1RACTU	0
71	C3, C36, C335	CAP, CERM, 0.1uF, 25V, +/-5%, X7R, 0603	Kemet	C0603C104J3RACTU	0
72	C7, C8, C16, C18, C33, C45, C49, C50, C55, C56, C61, C62, C67, C68, C73, C74, C79, C80, C301, C303, C305	CAP, CERM, 0.1uF, 16V, +/-10%, X7R, 0603	Kemet	C0603C104K4RACTU	0
73	C39, C40, C333, Cb1_VCO, Cb2_B1, Cb2_VCO, Cb2pVCO	Technology, Dielectric, xxV, xx%		DNP_CAP	0
74	C316, C320, C327, C328, C332, C334, C336	CAP, CERM, 0.1uF, 16V, +/-5%, X7R, 0603	Kemet	C0603C104J4RACTU	0

75	C337, C343, C347, C353, C356, C364	CAP, CERM, 1uF, 10V, +/-10%, X5R, 0603	Kemet	C0603C105K8PACTU	0
76	C338, C344, C348, C354, C357, C365	CAP, CERM, 0.1uF, 25V, +/-10%, X7R, 0603	Kemet	C0603C104K3RACTU	0
77	C339, C345, C349, C355, C358, C366	CAP, CERM, 0.01uF, 100V, +/-10%, X7R, 0603	Kemet	C0603C103K1RACTU	0
78	CLKin0_SEL, CLKin1_SEL, Status_Hold, Status_LD, SYNC	Connector, SMA Jack, Vertical, Gold, SMD	Emerson Network Power Connectivity	142-0711-201	0
79	CLKout1, CLKout1*, CLKout3, CLKout3*, CLKout5, CLKout5*, CLKout7, CLKout7*, CLKout9, CLKout9*, CLKout11, CLKout11*, FBCLKin/CLKin1, OScin, OSCin*, Vtune1	Connector, SMT, End launch SMA 50 Ohm	Emerson Network Power	142-0701-851	0
80	D300	Diode, Zener, 3.3V, 150mW, SOD-523F	Comchip Technology	CZRU52C3V3	0
81	GND_TP, Vcc_TP			DNP_TP	0
82	HWB, RESET		APEM Components, LLC	ADTSM31NV	0
83	J400	CONN RCPT MINI USB2.0 5POS SMD	Hirose Electric Co. Ltd.	UX60SA-MB-5ST	0

84	R1, R20, R23, R51, R52, R53, R54, R60, R63, R66, R69, R71, R72, R75, R76, R77, R78, R230, R300, R301, R305, R306, R308, R335, R339, R352, R363, R367, R370	RES, 0 ohm, 5%, 0.1W, 0603	Vishay-Dale	CRCW06030000Z0EA	0
85	R5, R8, R14, R25, R33, R34, R41, R48, R64, R68, R90, R96, R99, R114, R121, R135, R141, R157, R163, R179, R187, R204, R209, R225, R376	RES, 51 ohm, 5%, 0.1W, 0603	Vishay-Dale	CRCW060351R0JNEA	0
86	R6, R7, R15, R17, R31, R32, R39, R40, R49, R50, R79, R314	RES, 270 ohm, 5%, 0.1W, 0603	Vishay-Dale	CRCW0603270RJNEA	0

87	R10, R16, R88, R94, R97, R100, R113, R115, R119, R122, R136, R139, R143, R145, R159, R161, R165, R167, R180, R183, R185, R188, R201, R202, R207, R210, R223, R226	RES, 120 ohm, 5%, 0.1W, 0603	Vishay-Dale	CRCW0603120RJNEA	0
88	R28, R42, R65	RES, 100 ohm, 5%, 0.1W, 0603	Vishay-Dale	CRCW0603100RJNEA	0
89	R35, R44, R89, R95, R98, R101, R116, R118, R120, R123, R137, R140, R144, R146, R160, R162, R166, R168, R181, R184, R186, R189, R203, R205, R208, R211, R224, R227	RES, 82 ohm, 5%, 0.1W, 0603	Vishay-Dale	CRCW060382R0JNEA	0

90	R38, R45, R91, R93, R105, R106, R109, R110, R127, R128, R131, R132, R149, R150, R153, R154, R171, R172, R175, R176, R193, R194, R197, R198, R214, R216, R219, R220	RES, 62 ohm, 5%, 0.1W, 0603	Vishay-Dale	CRCW060362R0JNEA	0
91	R86, R87	RES, 27k ohm, 5%, 0.1W, 0603	Vishay-Dale	CRCW060327K0JNEA	0
92	R92	RES, 68 ohm, 5%, 0.1W, 0603	Vishay-Dale	CRCW060368R0JNEA	0
93	R147, R148, R155, R156, R169, R170, R177, R178, R191, R192, R199, R200	RES, 240 ohm, 5%, 0.1W, 0603	Vishay-Dale	CRCW0603240RJNEA	0
94	R302, R303, R310, R311, R401	RES, 10k ohm, 5%, 0.1W, 0603	Vishay-Dale	CRCW060310K0JNEA	0
95	R309, Rb2_VCO	x%, x.xxxW		DNP_RES	0
96	R323	RES, 2.2k ohm, 5%, 0.1W, 0603	Vishay-Dale	CRCW06032K20JNEA	0
97	R326, R328, R330	FB, 1000 ohm, 600 mA, 0603	Murata	BLM18HE102SN1D	0
98	R334	RES, 0 ohm, 5%, 0.125W, 0805	Vishay-Dale	CRCW08050000Z0EA	0
99	R360	RES, 51k ohm, 5%, 0.1W, 0603	Vishay-Dale	CRCW060351K0JNEA	0
100	R403, R406, R408, R409, R410	RES, 33 ohm, 5%, 0.1W, 0603	Vishay-Dale	CRCW060333R0JNEA	0
101	U3	VCO		CRO2949A-LF	0
102	U301	3-Terminal Adjustable Regulator	Texas Instruments	LM317AEMP	0
103	U400, Y400				0
104	Y300, Y301			DNP_XTAL	0

Appendix E: PCB Layers Stackup

6-layer PCB Stackup includes:

- Top Layer for high-priority high-frequency signals (2 oz.)
- RO4003 Dielectric, 16 mils
- RF Ground plane (1 oz.)
- FR4, 4 mils
- Power plane #1 (1 oz.)
- FR4, 12.6 mils
- Ground plane (1 oz.)
- FR4, 8 mils
- Power Plane #2 (1 oz.)
- FR4, 12 mils
- Bottom Layer copper clad for thermal relief (2 oz.)

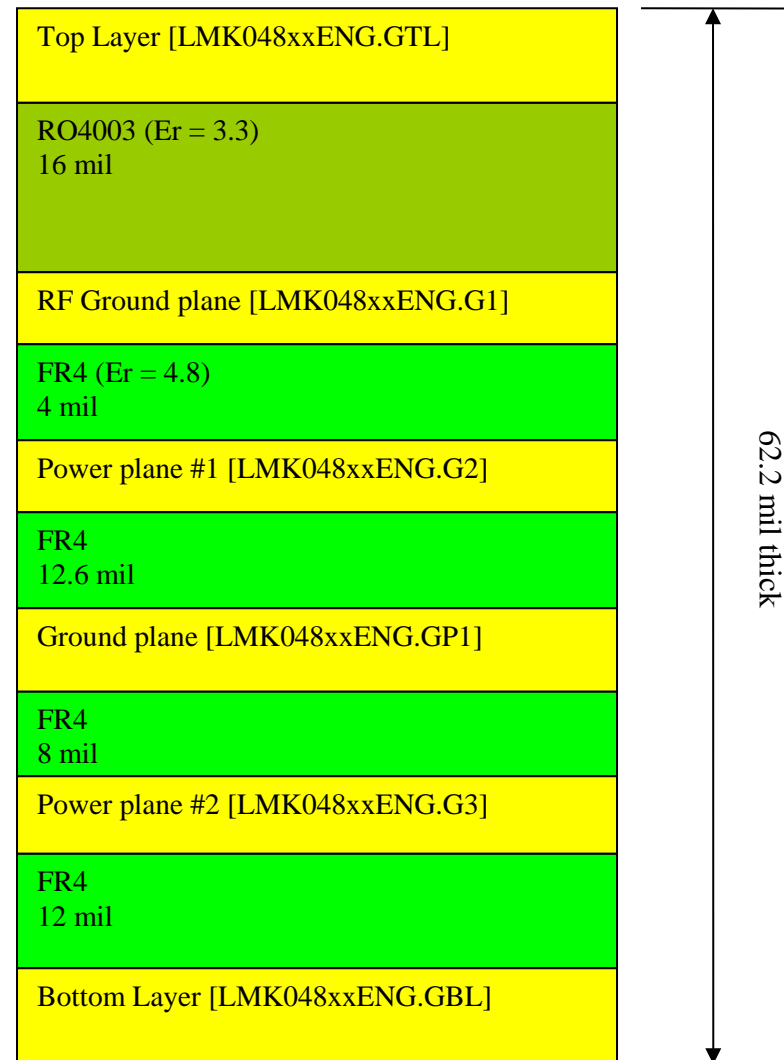

Appendix F: PCB Layout

Layer #1 – Top

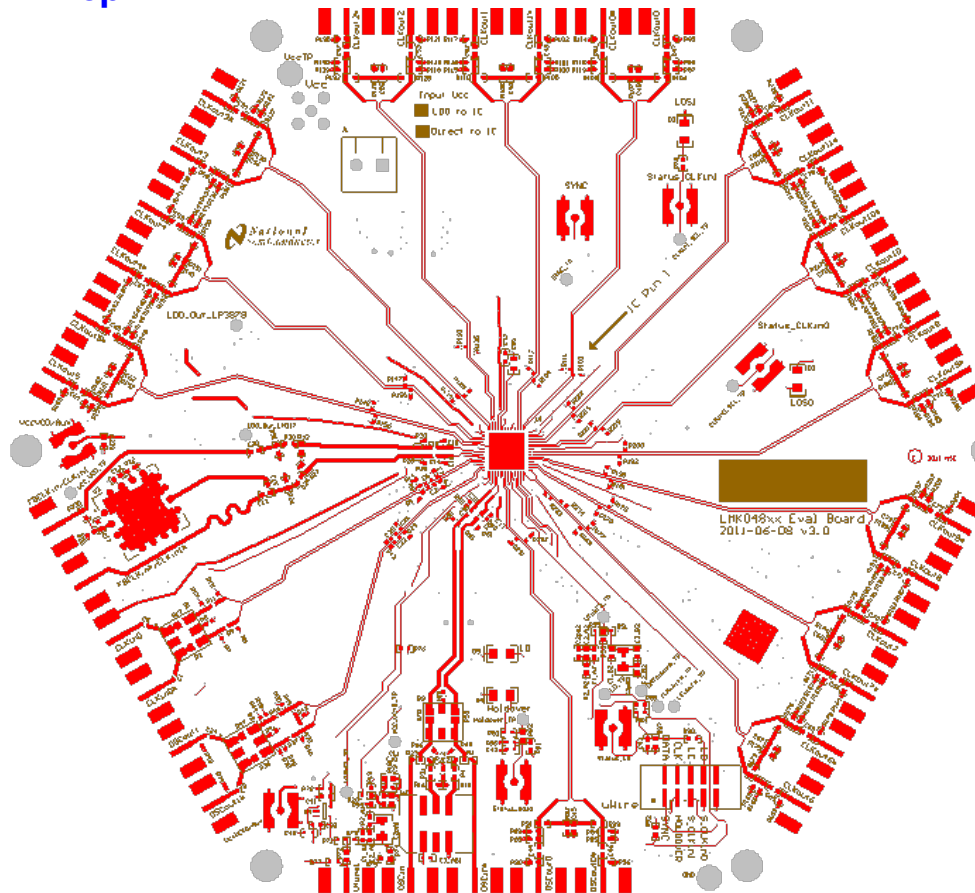

Layer #2 – RF Ground Plane (Inverted)

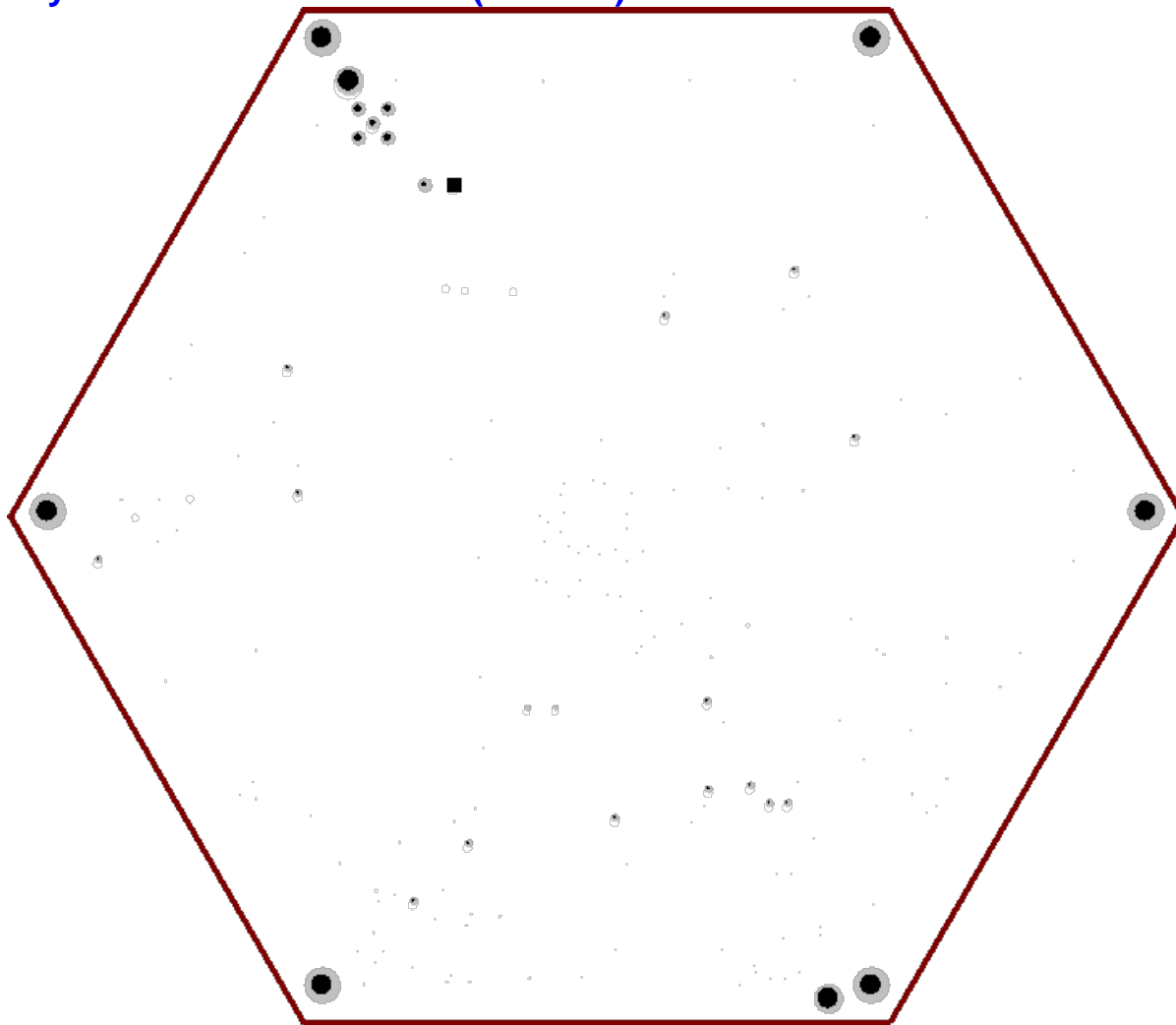

Layer #3 – Vcc Planes

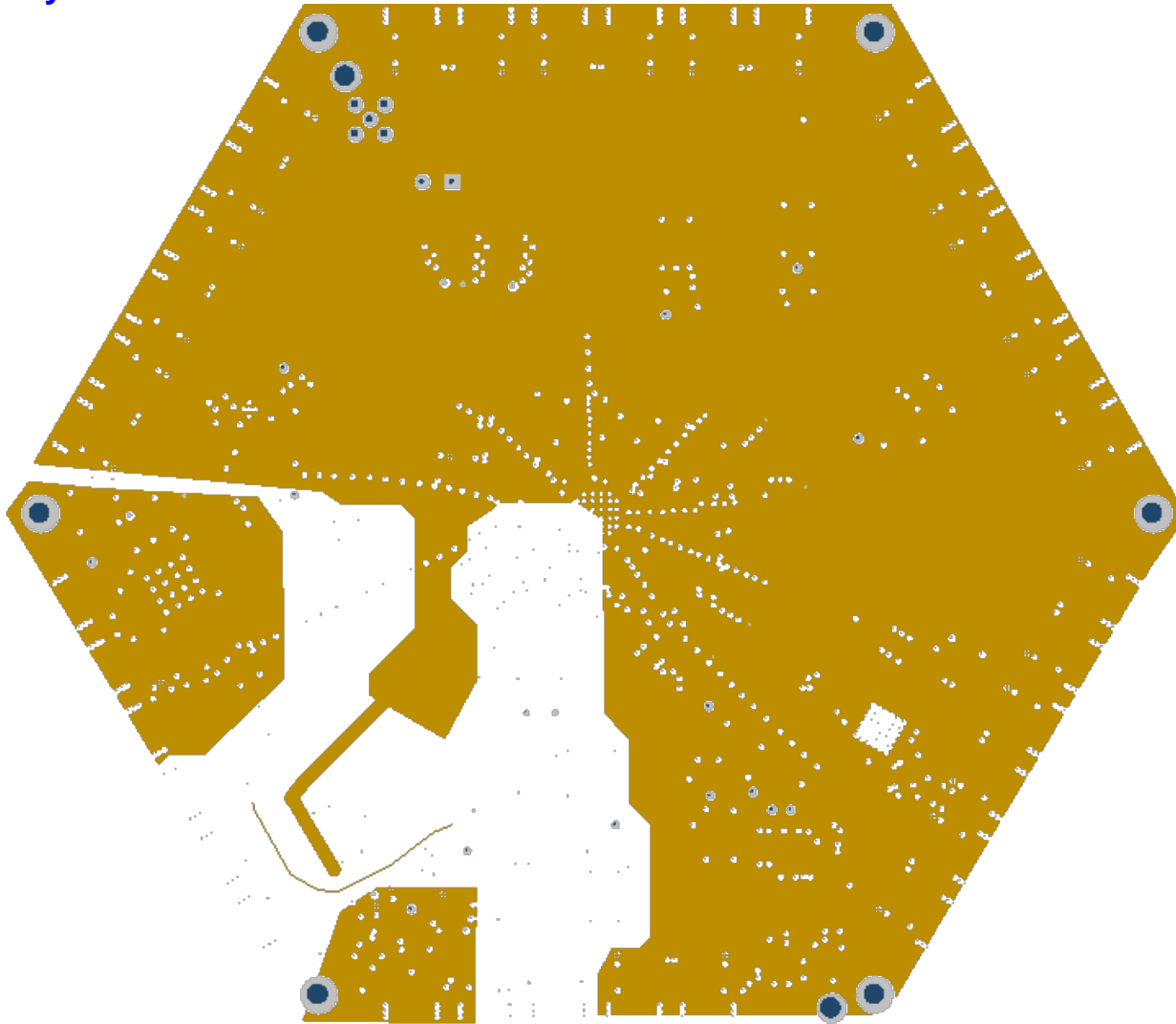

Layer #4 – Ground Plane (Inverted)

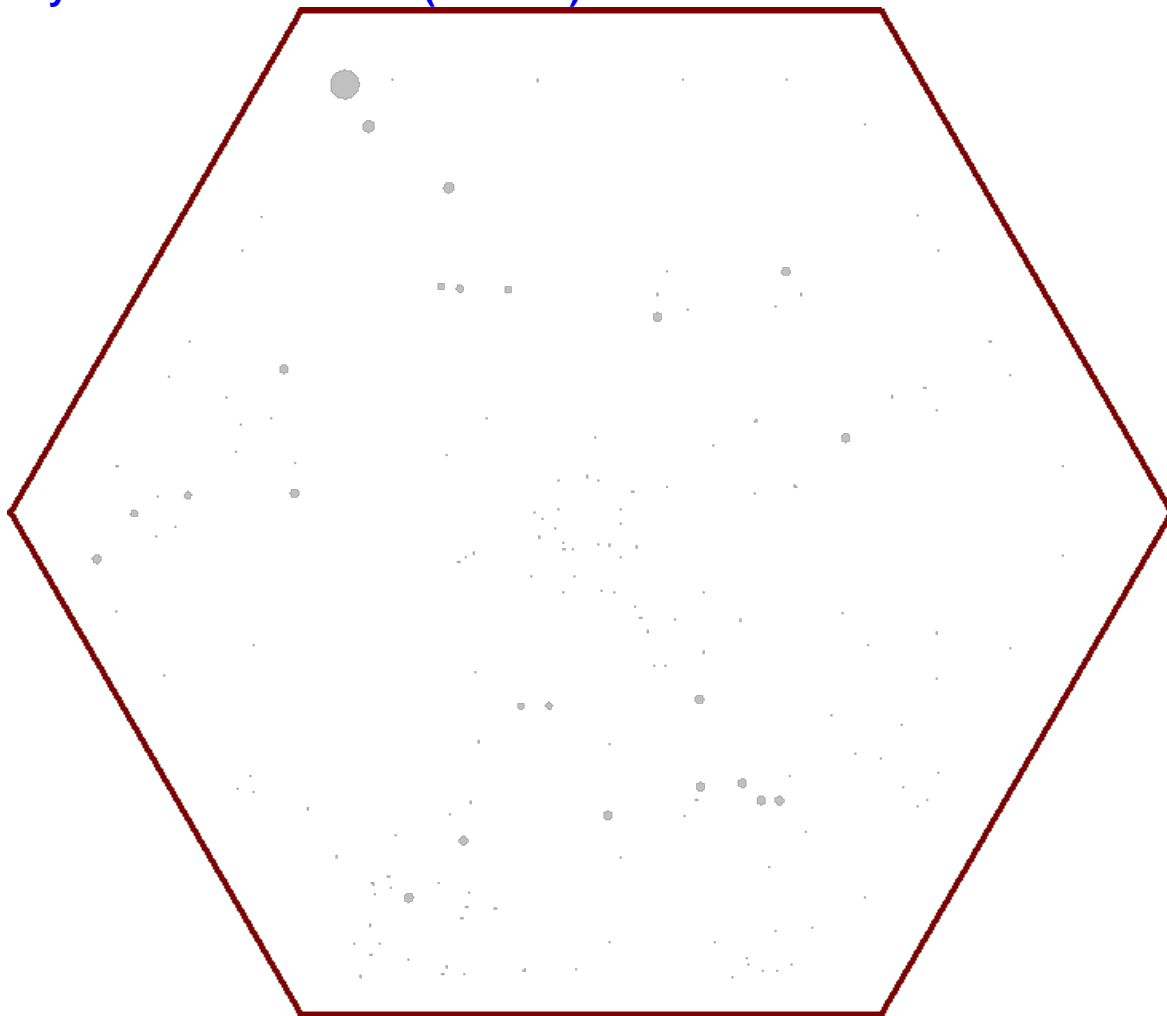

Layer # 5 – Vcc Planes 2



Layer #6 – Bottom

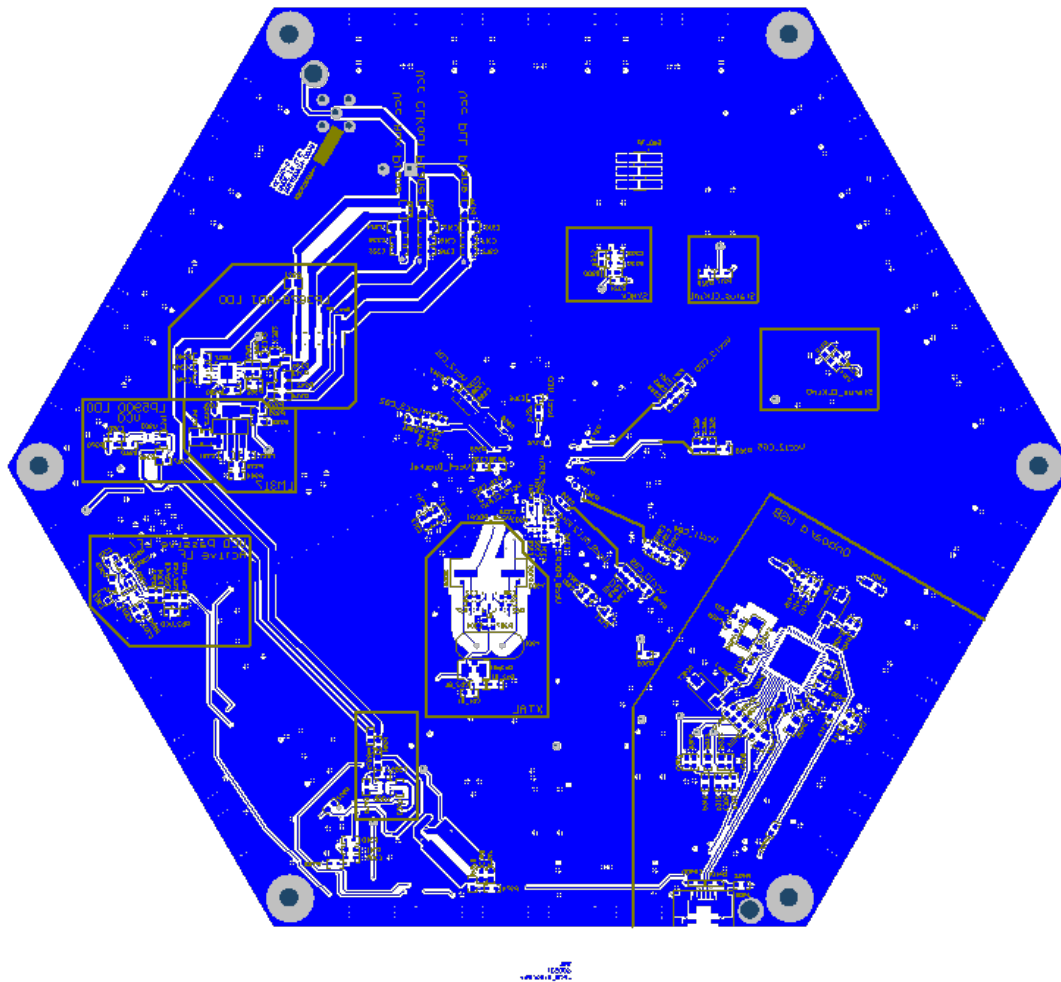

Bottom Page 64

860

Layers #1 and 6 – Top and Bottom (Composite)

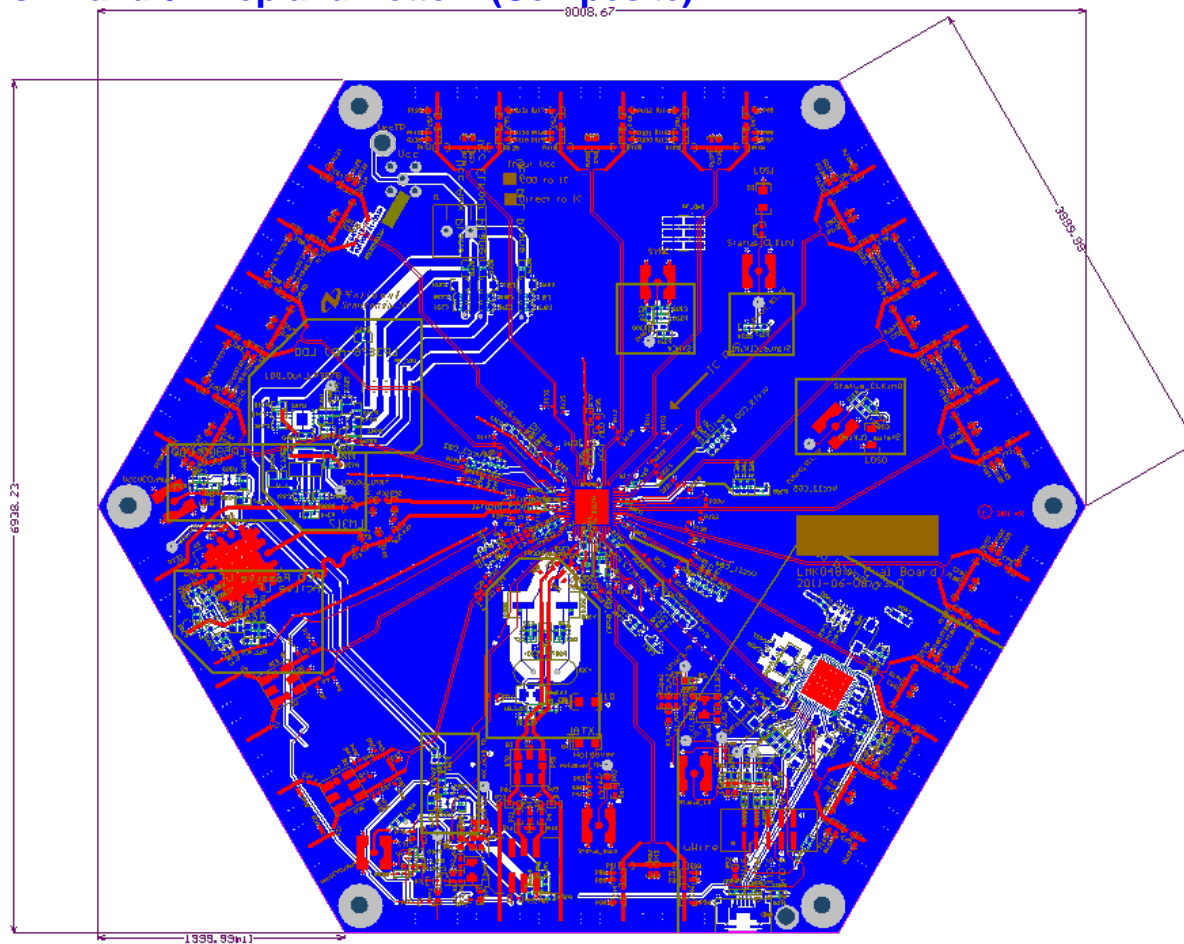

8008.67

6926.23

Appendix G: EVM Software and Communication: Interfacing uWire

Codeloader is the software used to communicate with the EVM (Please download the latest version from TI.com - <http://www.ti.com/tool/codeloader>). This EVM can be controlled through the uWire interface on board. There are two options in communicating with the uWire interface from the computer.

OPTION 1

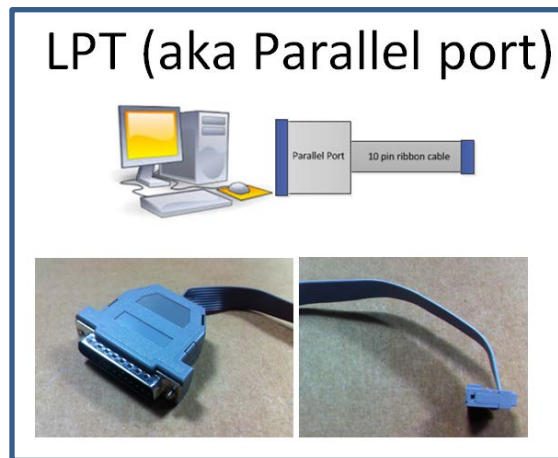

Open Codeloader.exe → Click “Select Device” → Click “Port Setup” tab → Click “LPT” (in Communication Mode)

OPTION 2

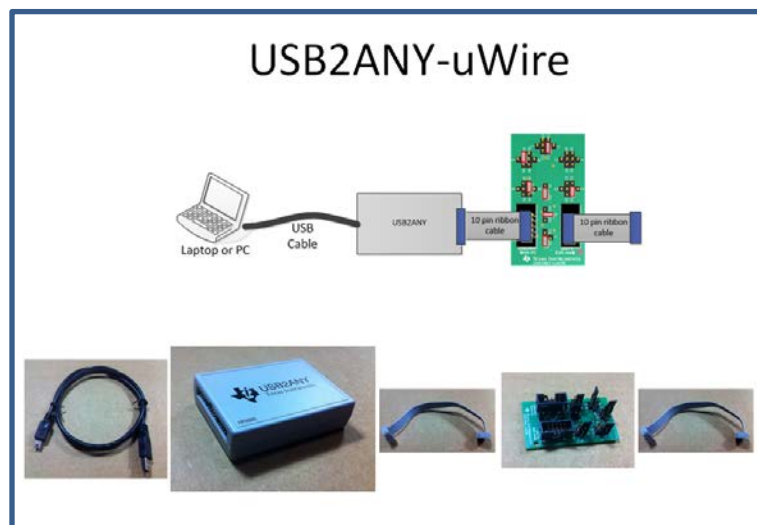

The Adapter Board

This table describes the pins configuration on the adapter board for each EVM board (See examples below table)

EVM	Jumper Bank								Code Loader Configuration
	A	B	C	D	E	F	G	H	
LMX2581	A4	B1	C2		E5	F1	G1	H1	BUFEN (pin 1), Trigger (pin 7)
LMX2541	A4		C3		E4	F1	G1	H1	CE (pin 1), Trigger (pin 10)
LMK0400x	A0		C3		E5	F1	G1	H1	GOE (pin 7)
LMK01000	A0		C1		E5	F1	G1	H1	GOE (pin 7)
LMK030xx	A0		C1		E5	F1	G1	H1	SYNC (pin 7)
LMK02000	A0		C1		E5	F1	G1	H1	SYNC (pin 7)
LMK0480x	A0	B2	C3		E5	F0	G0	H1	Status_CLKin1 (pin 3)
LMK04816/4906	A0	B2	C3		E5	F0	G0	H1	Status_CLKin1 (pin 3)
LMK01801	A0	B4	C5		E2	F0	G0	H1	Test (pin 3), SYNC0 (pin 10)
LMK0482x (prelease)	A0	B5	C3	D2	E4	F0	G0	H1	CLKin1_SEL (pin 6), Reset (pin 10)
LMX2531	A0				E5	F2	G1	H2	Trigger (pin 1)
LMX2485/7	A0		C1		E5	F2	G1	H0	ENOSC (pin 7), CE (pin 10)
LMK03200	A0				E5	F0	G0	H1	SYNC (pin 7)
LMK03806	A0		C1		E5	F0	G0	H1	
LMK04100	A0		C1		E5	F1	G1	H1	

Example adapter configuration (LMK01801)

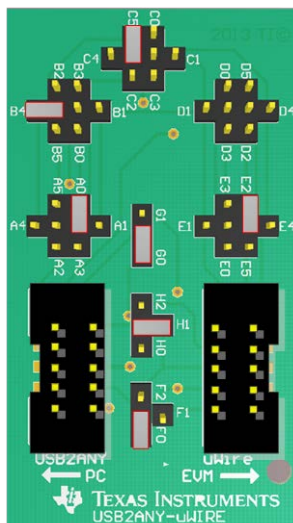

Open Codeloader.exe → Click “Select Device” → Click “Port Setup” Tab → Click “USB” (in Communication Mode)

*Remember to also make modifications in “Pin Configuration” Section according to Table above.

Appendix H: Troubleshooting Information

If the evaluation board is not behaving as expected, the most likely issues are...

- 1) Board communication issue
- 2) Incorrect Programming of the device
- 3) Setup Error

Refer to this checklist for a practical guide on identifying/exposing possible issues.

1) Confirm Communications

2) Confirm PLL1 operation/locking

- 1) Program LD_MUX = "PLL1_R/2"
- 2) Confirm that LD pin output is half the expected phase detector frequency of PLL1.
 - i. If not, examine CLKin_SEL programming.
 - ii. If not, examine CLKin0_BUFTYPE / CLKin1_BUFTYPE.
 - iii. If not, examine PLL1 register R programming.
 - iv. If not, examine physical CLKin input.
- 3) Program LD_MUX = "PLL1_N /2"
- 4) Confirm that LD pin output is half the expected phase detector frequency of PLL1.
 - i. If not, examine PLL1 register N programming.
 - ii. If not, examine physical OSCin input.

Naturally, the output frequency of the above two items, PLL 1 R Divider/2 and PLL 1 N Divider /2, on LD pin should be the same frequency.

- 5) Program LD_MUX = "PLL1_DLD"
- 6) Confirm the LD pin output is high.
 - i. If high, then PLL1 is locked, continue to PLL2 operation/locking.
- 7) If LD pin output is low, but the frequencies are the same, it is possible that excessive leakage on Vtune pin is causing the digital lock detect to not activate. By default PLL2 waits for the digital lock detect to go high before allowing PLL2 and the integrated VCO to lock. Different VCXO models have different input leakage specifications. High leakage, low PLL1 phase detector frequencies, and low PLL1 charge pump current settings can cause the PLL1 charge pump to operate longer than the digital lock detect timeout which allows the device to lock, but prevents the digital lock detect from activating.
 - i. Redesign PLL1 loop filter with higher phase detector frequency
 - ii. Redesign PLL1 loop filter with higher charge pump current
 - iii. Isolate VCXO tuning input from PLL1 charge pump with an op amp.

3) Confirm PLL2 operation/locking

- 1) Program LD_MUX = "PLL2_R/2"
- 2) Confirm that LD pin output is half the expected phase detector frequency of PLL2.
 - i. If not, examine PLL2_R programming.
 - ii. If not, examine physical OSCin input.
- 3) Program LD_MUX = "PLL2_N/2"
- 4) Confirm that LD pin output is half the expected phase detector frequency of PLL2.
 - i. If not, confirm OSCin_FREQ is programmed to OSCin frequency.
 - ii. If not, examine PLL2_N programming.

Naturally, the output frequency of the above two items should be the same frequency.

- 5) Program LD_MUX = "PLL2 DLD"
- 6) Confirm the LD pin output is high.
- 7) Program LD_MUX = "PLL1 & PLL2 DLD"
- 8) Confirm the LD pin output is high.

ADDITIONAL TERMS AND CONDITIONS, WARNINGS, RESTRICTIONS, AND DISCLAIMERS FOR EVALUATION MODULES

Texas Instruments Incorporated (TI) markets, sells, and loans all evaluation boards, kits, and/or modules (EVMs) pursuant to, and user expressly acknowledges, represents, and agrees, and takes sole responsibility and risk with respect to, the following:

1. User agrees and acknowledges that EVMs are intended to be handled and used for feasibility evaluation only in laboratory and/or development environments. Notwithstanding the foregoing, in certain instances, TI makes certain EVMs available to users that do not handle and use EVMs solely for feasibility evaluation only in laboratory and/or development environments, but may use EVMs in a hobbyist environment. All EVMs made available to hobbyist users are FCC certified, as applicable. Hobbyist users acknowledge, agree, and shall comply with all applicable terms, conditions, warnings, and restrictions in this document and are subject to the disclaimer and indemnity provisions included in this document.
2. Unless otherwise indicated, EVMs are not finished products and not intended for consumer use. EVMs are intended solely for use by technically qualified electronics experts who are familiar with the dangers and application risks associated with handling electrical mechanical components, systems, and subsystems.
3. User agrees that EVMs shall not be used as, or incorporated into, all or any part of a finished product.
4. User agrees and acknowledges that certain EVMs may not be designed or manufactured by TI.
5. User must read the user's guide and all other documentation accompanying EVMs, including without limitation any warning or restriction notices, prior to handling and/or using EVMs. Such notices contain important safety information related to, for example, temperatures and voltages. For additional information on TI's environmental and/or safety programs, please visit www.ti.com/esh or contact TI.
6. User assumes all responsibility, obligation, and any corresponding liability for proper and safe handling and use of EVMs.
7. Should any EVM not meet the specifications indicated in the user's guide or other documentation accompanying such EVM, the EVM may be returned to TI within 30 days from the date of delivery for a full refund. THE FOREGOING LIMITED WARRANTY IS THE EXCLUSIVE WARRANTY MADE BY TI TO USER AND IS IN LIEU OF ALL OTHER WARRANTIES, EXPRESSED, IMPLIED, OR STATUTORY, INCLUDING ANY WARRANTY OF MERCHANTABILITY OR FITNESS FOR ANY PARTICULAR PURPOSE. TI SHALL NOT BE LIABLE TO USER FOR ANY INDIRECT, SPECIAL, INCIDENTAL, OR CONSEQUENTIAL DAMAGES RELATED TO THE HANDLING OR USE OF ANY EVM.
8. No license is granted under any patent right or other intellectual property right of TI covering or relating to any machine, process, or combination in which EVMs might be or are used. TI currently deals with a variety of customers, and therefore TI's arrangement with the user is not exclusive. TI assumes no liability for applications assistance, customer product design, software performance, or infringement of patents or services with respect to the handling or use of EVMs.
9. User assumes sole responsibility to determine whether EVMs may be subject to any applicable federal, state, or local laws and regulatory requirements (including but not limited to U.S. Food and Drug Administration regulations, if applicable) related to its handling and use of EVMs and, if applicable, compliance in all respects with such laws and regulations.
10. User has sole responsibility to ensure the safety of any activities to be conducted by it and its employees, affiliates, contractors or designees, with respect to handling and using EVMs. Further, user is responsible to ensure that any interfaces (electronic and/or mechanical) between EVMs and any human body are designed with suitable isolation and means to safely limit accessible leakage currents to minimize the risk of electrical shock hazard.
11. User shall employ reasonable safeguards to ensure that user's use of EVMs will not result in any property damage, injury or death, even if EVMs should fail to perform as described or expected.
12. User shall be solely responsible for proper disposal and recycling of EVMs consistent with all applicable federal, state, and local requirements.

Certain Instructions. User shall operate EVMs within TI's recommended specifications and environmental considerations per the user's guide, accompanying documentation, and any other applicable requirements. Exceeding the specified ratings (including but not limited to input and output voltage, current, power, and environmental ranges) for EVMs may cause property damage, personal injury or death. If there are questions concerning these ratings, user should contact a TI field representative prior to connecting interface electronics including input power and intended loads. Any loads applied outside of the specified output range may result in unintended and/or inaccurate operation and/or possible permanent damage to the EVM and/or interface electronics. Please consult the applicable EVM user's guide prior to connecting any load to the EVM output. If there is uncertainty as to the load specification, please contact a TI field representative. During normal operation, some circuit components may have case temperatures greater than 60°C as long as the input and output are maintained at a normal ambient operating temperature. These components include but are not limited to linear regulators, switching transistors, pass transistors, and current sense resistors which can be identified using EVMs' schematics located in the applicable EVM user's guide. When placing measurement probes near EVMs during normal operation, please be aware that EVMs may become very warm. As with all electronic evaluation tools, only qualified personnel knowledgeable in electronic measurement and diagnostics normally found in development environments should use EVMs.

Agreement to Defend, Indemnify and Hold Harmless. User agrees to defend, indemnify, and hold TI, its directors, officers, employees, agents, representatives, affiliates, licensors and their representatives harmless from and against any and all claims, damages, losses, expenses, costs and liabilities (collectively, "Claims") arising out of, or in connection with, any handling and/or use of EVMs. User's indemnity shall apply whether Claims arise under law of tort or contract or any other legal theory, and even if EVMs fail to perform as described or expected.

Safety-Critical or Life-Critical Applications. If user intends to use EVMs in evaluations of safety critical applications (such as life support), and a failure of a TI product considered for purchase by user for use in user's product would reasonably be expected to cause severe personal injury or death such as devices which are classified as FDA Class III or similar classification, then user must specifically notify TI of such intent and enter into a separate Assurance and Indemnity Agreement.

RADIO FREQUENCY REGULATORY COMPLIANCE INFORMATION FOR EVALUATION MODULES

Texas Instruments Incorporated (TI) evaluation boards, kits, and/or modules (EVMs) and/or accompanying hardware that is marketed, sold, or loaned to users may or may not be subject to radio frequency regulations in specific countries.

General Statement for EVMs Not Including a Radio

For EVMs not including a radio and not subject to the U.S. Federal Communications Commission (FCC) or Industry Canada (IC) regulations, TI intends EVMs to be used only for engineering development, demonstration, or evaluation purposes. EVMs are not finished products typically fit for general consumer use. EVMs may nonetheless generate, use, or radiate radio frequency energy, but have not been tested for compliance with the limits of computing devices pursuant to part 15 of FCC or the ICES-003 rules. Operation of such EVMs may cause interference with radio communications, in which case the user at his own expense will be required to take whatever measures may be required to correct this interference.

General Statement for EVMs including a radio

User Power/Frequency Use Obligations: For EVMs including a radio, the radio included in such EVMs is intended for development and/or professional use only in legally allocated frequency and power limits. Any use of radio frequencies and/or power availability in such EVMs and their development application(s) must comply with local laws governing radio spectrum allocation and power limits for such EVMs. It is the user's sole responsibility to only operate this radio in legally acceptable frequency space and within legally mandated power limitations. Any exceptions to this are strictly prohibited and unauthorized by TI unless user has obtained appropriate experimental and/or development licenses from local regulatory authorities, which is the sole responsibility of the user, including its acceptable authorization.

U.S. Federal Communications Commission Compliance

For EVMs Annotated as FCC – FEDERAL COMMUNICATIONS COMMISSION Part 15 Compliant

Caution

This device complies with part 15 of the FCC Rules. Operation is subject to the following two conditions: (1) This device may not cause harmful interference, and (2) this device must accept any interference received, including interference that may cause undesired operation. Changes or modifications could void the user's authority to operate the equipment.

FCC Interference Statement for Class A EVM devices

This equipment has been tested and found to comply with the limits for a Class A digital device, pursuant to part 15 of the FCC Rules. These limits are designed to provide reasonable protection against harmful interference when the equipment is operated in a commercial environment. This equipment generates, uses, and can radiate radio frequency energy and, if not installed and used in accordance with the instruction manual, may cause harmful interference to radio communications. Operation of this equipment in a residential area is likely to cause harmful interference in which case the user will be required to correct the interference at its own expense.

FCC Interference Statement for Class B EVM devices

This equipment has been tested and found to comply with the limits for a Class B digital device, pursuant to part 15 of the FCC Rules. These limits are designed to provide reasonable protection against harmful interference in a residential installation. This equipment generates, uses and can radiate radio frequency energy and, if not installed and used in accordance with the instructions, may cause harmful interference to radio communications. However, there is no guarantee that interference will not occur in a particular installation. If this equipment does cause harmful interference to radio or television reception, which can be determined by turning the equipment off and on, the user is encouraged to try to correct the interference by one or more of the following measures:

- Reorient or relocate the receiving antenna.
- Increase the separation between the equipment and receiver.
- Connect the equipment into an outlet on a circuit different from that to which the receiver is connected.
- Consult the dealer or an experienced radio/TV technician for help.

Industry Canada Compliance (English)

For EVMs Annotated as IC – INDUSTRY CANADA Compliant:

This Class A or B digital apparatus complies with Canadian ICES-003.

Changes or modifications not expressly approved by the party responsible for compliance could void the user's authority to operate the equipment.

Concerning EVMs Including Radio Transmitters

This device complies with Industry Canada licence-exempt RSS standard(s). Operation is subject to the following two conditions: (1) this device may not cause interference, and (2) this device must accept any interference, including interference that may cause undesired operation of the device.

Concerning EVMs Including Detachable Antennas

Under Industry Canada regulations, this radio transmitter may only operate using an antenna of a type and maximum (or lesser) gain approved for the transmitter by Industry Canada. To reduce potential radio interference to other users, the antenna type and its gain should be so chosen that the equivalent isotropically radiated power (e.i.r.p.) is not more than that necessary for successful communication.

This radio transmitter has been approved by Industry Canada to operate with the antenna types listed in the user guide with the maximum permissible gain and required antenna impedance for each antenna type indicated. Antenna types not included in this list, having a gain greater than the maximum gain indicated for that type, are strictly prohibited for use with this device.

Canada Industry Canada Compliance (French)

Cet appareil numérique de la classe A ou B est conforme à la norme NMB-003 du Canada

Les changements ou les modifications pas expressément approuvés par la partie responsable de la conformité ont pu vider l'autorité de l'utilisateur pour actionner l'équipement.

Concernant les EVMs avec appareils radio

Le présent appareil est conforme aux CNR d'Industrie Canada applicables aux appareils radio exempts de licence. L'exploitation est autorisée aux deux conditions suivantes : (1) l'appareil ne doit pas produire de brouillage, et (2) l'utilisateur de l'appareil doit accepter tout brouillage radioélectrique subi, même si le brouillage est susceptible d'en compromettre le fonctionnement.

Concernant les EVMs avec antennes détachables

Conformément à la réglementation d'Industrie Canada, le présent émetteur radio peut fonctionner avec une antenne d'un type et d'un gain maximal (ou inférieur) approuvé pour l'émetteur par Industrie Canada. Dans le but de réduire les risques de brouillage radioélectrique à l'intention des autres utilisateurs, il faut choisir le type d'antenne et son gain de sorte que la puissance isotrope rayonnée équivalente (p.i.r.e.) ne dépasse pas l'intensité nécessaire à l'établissement d'une communication satisfaisante.

Le présent émetteur radio a été approuvé par Industrie Canada pour fonctionner avec les types d'antenne énumérés dans le manuel d'usage et ayant un gain admissible maximal et l'impédance requise pour chaque type d'antenne. Les types d'antenne non inclus dans cette liste, ou dont le gain est supérieur au gain maximal indiqué, sont strictement interdits pour l'exploitation de l'émetteur.

Mailing Address: Texas Instruments, Post Office Box 655303, Dallas, Texas 75265
Copyright © 2014, Texas Instruments Incorporated

Important Notice for Users of EVMs Considered “Radio Frequency Products” in Japan

EVMs entering Japan are NOT certified by TI as conforming to Technical Regulations of Radio Law of Japan.

If user uses EVMs in Japan, user is required by Radio Law of Japan to follow the instructions below with respect to EVMs:

1. Use EVMs in a shielded room or any other test facility as defined in the notification #173 issued by Ministry of Internal Affairs and Communications on March 28, 2006, based on Sub-section 1.1 of Article 6 of the Ministry's Rule for Enforcement of Radio Law of Japan,
2. Use EVMs only after user obtains the license of Test Radio Station as provided in Radio Law of Japan with respect to EVMs, or
3. Use of EVMs only after user obtains the Technical Regulations Conformity Certification as provided in Radio Law of Japan with respect to EVMs. Also, do not transfer EVMs, unless user gives the same notice above to the transferee. Please note that if user does not follow the instructions above, user will be subject to penalties of Radio Law of Japan.

<http://www.tij.co.jp>

【無線電波を送信する製品の開発キットをお使いになる際の注意事項】本開発キットは技術基準適合証明を受けておりません。本製品のご使用に際しては、電波法遵守のため、以下のいずれかの措置を取っていただく必要がありますのでご注意ください。

1. 電波法施行規則第6条第1項第1号に基づく平成18年3月28日総務省告示第173号で定められた電波暗室等の試験設備でご使用いただく。
2. 実験局の免許を取得後ご使用いただく。
3. 技術基準適合証明を取得後ご使用いただく。。

なお、本製品は、上記の「ご使用にあたっての注意」を譲渡先、移転先に通知しない限り、譲渡、移転できないものとします

上記を遵守頂けない場合は、電波法の罰則が適用される可能性があることをご留意ください。

日本テキサス・インスツルメンツ株式会社

東京都新宿区西新宿6丁目24番1号

西新宿三井ビル

<http://www.tij.co.jp>

Texas Instruments Japan Limited

(address) 24-1, Nishi-Shinjuku 6 chome, Shinjuku-ku, Tokyo, Japan

IMPORTANT NOTICE

Texas Instruments Incorporated and its subsidiaries (TI) reserve the right to make corrections, enhancements, improvements and other changes to its semiconductor products and services per JESD46, latest issue, and to discontinue any product or service per JESD48, latest issue. Buyers should obtain the latest relevant information before placing orders and should verify that such information is current and complete. All semiconductor products (also referred to herein as "components") are sold subject to TI's terms and conditions of sale supplied at the time of order acknowledgment.

TI warrants performance of its components to the specifications applicable at the time of sale, in accordance with the warranty in TI's terms and conditions of sale of semiconductor products. Testing and other quality control techniques are used to the extent TI deems necessary to support this warranty. Except where mandated by applicable law, testing of all parameters of each component is not necessarily performed.

TI assumes no liability for applications assistance or the design of Buyers' products. Buyers are responsible for their products and applications using TI components. To minimize the risks associated with Buyers' products and applications, Buyers should provide adequate design and operating safeguards.

TI does not warrant or represent that any license, either express or implied, is granted under any patent right, copyright, mask work right, or other intellectual property right relating to any combination, machine, or process in which TI components or services are used. Information published by TI regarding third-party products or services does not constitute a license to use such products or services or a warranty or endorsement thereof. Use of such information may require a license from a third party under the patents or other intellectual property of the third party, or a license from TI under the patents or other intellectual property of TI.

Reproduction of significant portions of TI information in TI data books or data sheets is permissible only if reproduction is without alteration and is accompanied by all associated warranties, conditions, limitations, and notices. TI is not responsible or liable for such altered documentation. Information of third parties may be subject to additional restrictions.

Resale of TI components or services with statements different from or beyond the parameters stated by TI for that component or service voids all express and any implied warranties for the associated TI component or service and is an unfair and deceptive business practice. TI is not responsible or liable for any such statements.

Buyer acknowledges and agrees that it is solely responsible for compliance with all legal, regulatory and safety-related requirements concerning its products, and any use of TI components in its applications, notwithstanding any applications-related information or support that may be provided by TI. Buyer represents and agrees that it has all the necessary expertise to create and implement safeguards which anticipate dangerous consequences of failures, monitor failures and their consequences, lessen the likelihood of failures that might cause harm and take appropriate remedial actions. Buyer will fully indemnify TI and its representatives against any damages arising out of the use of any TI components in safety-critical applications.

In some cases, TI components may be promoted specifically to facilitate safety-related applications. With such components, TI's goal is to help enable customers to design and create their own end-product solutions that meet applicable functional safety standards and requirements. Nonetheless, such components are subject to these terms.

No TI components are authorized for use in FDA Class III (or similar life-critical medical equipment) unless authorized officers of the parties have executed a special agreement specifically governing such use.

Only those TI components which TI has specifically designated as military grade or "enhanced plastic" are designed and intended for use in military/aerospace applications or environments. Buyer acknowledges and agrees that any military or aerospace use of TI components which have **not** been so designated is solely at the Buyer's risk, and that Buyer is solely responsible for compliance with all legal and regulatory requirements in connection with such use.

TI has specifically designated certain components as meeting ISO/TS16949 requirements, mainly for automotive use. In any case of use of non-designated products, TI will not be responsible for any failure to meet ISO/TS16949.

Products

Audio	www.ti.com/audio
Amplifiers	amplifier.ti.com
Data Converters	dataconverter.ti.com
DLP® Products	www.dlp.com
DSP	dsp.ti.com
Clocks and Timers	www.ti.com/clocks
Interface	interface.ti.com
Logic	logic.ti.com
Power Mgmt	power.ti.com
Microcontrollers	microcontroller.ti.com
RFID	www.ti-rfid.com
OMAP Applications Processors	www.ti.com/omap
Wireless Connectivity	www.ti.com/wirelessconnectivity

Applications

Automotive and Transportation	www.ti.com/automotive
Communications and Telecom	www.ti.com/communications
Computers and Peripherals	www.ti.com/computers
Consumer Electronics	www.ti.com/consumer-apps
Energy and Lighting	www.ti.com/energy
Industrial	www.ti.com/industrial
Medical	www.ti.com/medical
Security	www.ti.com/security
Space, Avionics and Defense	www.ti.com/space-avionics-defense
Video and Imaging	www.ti.com/video

TI E2E Community

e2e.ti.com