

ISO / NFC Standards and Specifications Overview

NFC/RFID Training Module #1 (2014)
S2 MCU NFC/RFID Applications Team

HF RFID ISO STANDARDS

HF RFID ISO Standards Overview

- The main worldwide accepted High Frequency RFID air interface and protocol standards (since mid to late 1990's) are:
 - ISO14443
 - ISO15693
- Who makes the ISO standards?
 - The ISO standards are made from the efforts of inter-industry working groups on (in this case) the specific topic of RFID systems.
 - The standards have been created and are living documents, with additions, changes and corrections occurring at regular intervals.
- Why do we use ISO standards?
 - To provide a uniform set of rules & guidelines, which:
 - Provides a basis from which manufacturers of reader/writer transceivers and cards/tags can rely upon to ensure interoperability
 - Provides a framework for future improvements/additions
 - Provides a basis for other specification bodies to innovate from

HF RFID ISO Standards Overview

- A brief comparison of the standards:

Technical Aspect	ISO 14443A	ISO 14443B	ISO 15693	General Comments (For more specific feedback, pls request further info)
Origins	~1990	~1995	~2001	Type B was derived at a much later date than Type A, so has a number of advantages.
Data Rate	106 Kbs	106 up to 847 Kbs	1.65/26.4 kbs	Type B is adaptable to application speed requirements. 14443-3 supports negotiation of higher data-rates with Type B.
Anti-Collision	Medium Binary-search-tree with inefficiencies	Excellent Slotted-ALOHA with dynamic slot adaptation by reader	Excellent Slotted deterministic concept	Type B Slotted ALOHA is the more efficient and sophisticated anti-collision mechanism compared to binary tree search.
Multi-Applications	Yes - Medium	Yes - Fast	Yes - Slow	No clock recovery required with Type B for multi-applications.
Modulation Depth	100% (NO data processing DURING off pulses)	10% (Data processing DURING off pulses)	100% and 10%	100% modulation may offer greater noise immunity for long read-range applications >0.5-1m , but no difference for small read-range applications <.1m.
Air-Interface Complexity	Low (only 100%)	Low (only 10%)	Medium (10% and 100%)	Limited differences in air-interface complexity when using fixed depths of modulation.

HF RFID ISO Standards Overview

- **ISO/IEC 14443** is primarily used for **P**roximity Applications
 - Contactless Payments, High Security Access Control, ePassports, etc.
 - ISO14443 is logically divided into 4 parts
 - ISO14443-1 : Physical Characteristics of Cards (**P**ICCs)
 - ISO14443-2 : Power and Signal Air Interface
 - **Two PICC types, called -A and -B**
 - ISO14443-3 : Initialization (Activation) and Anti-Collision Command Set Protocol
 - ISO14443-4 : Transmission Protocol (Framework)
 - Uses ISO7816-4 for Application Layer command set

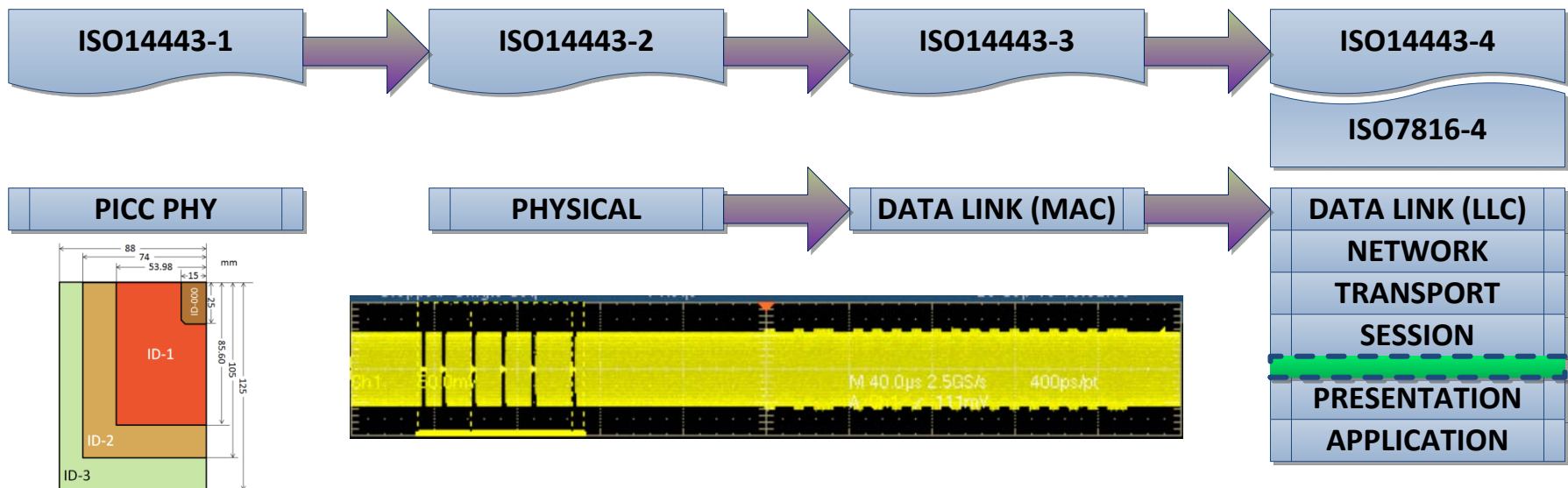

HF RFID ISO Standards Overview (cont.)

- **ISO/IEC 15693** is primarily used for **Vicinity Applications**
 - Access Control, Asset Tracking, Portable Data Storage, etc.
 - ISO15693 is logically divided into 3 parts
 - ISO15693-1 : Physical Characteristics of Cards (**VICCs**)
 - ISO15693-2 : Air Interface and Initialization
 - ISO15693-3 : Anti-Collision and Transmission Protocol
 - **NOTE:** ISO/IEC 18000-3 is medical application version of ISO15693

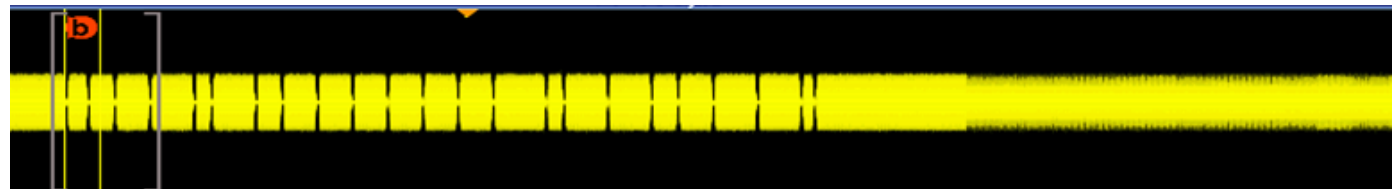
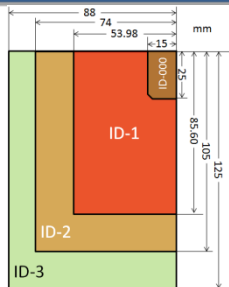

ISO14443A

ISO14443-2 , -3 for Type A

- **Air Interface Protocol –**

- Uses 100% Amplitude Shift Key (ASK) for PCD to PICC communications (downlink)
- The downlink is using a modified miller encoding, in which a 0 being transmitted causes no change, unless it is followed by a 0.
- Downlink symbols are defined as:
 - sequence X: after a time of half the bit duration (t_x) a PauseA shall occur,
 - sequence Y: for the full bit duration (t_b) no modulation shall occur
 - sequence Z: at the beginning of the bit duration (t_b) a PauseA shall occur.

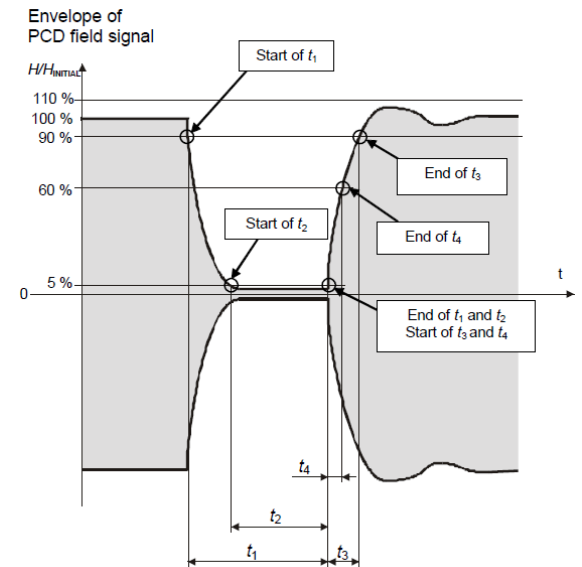
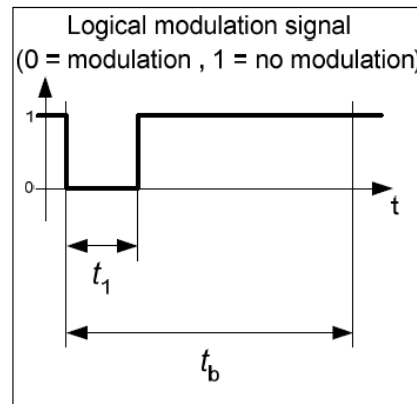
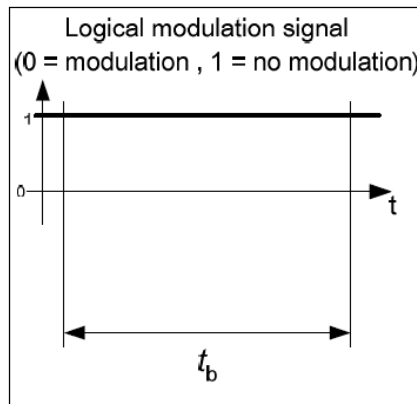
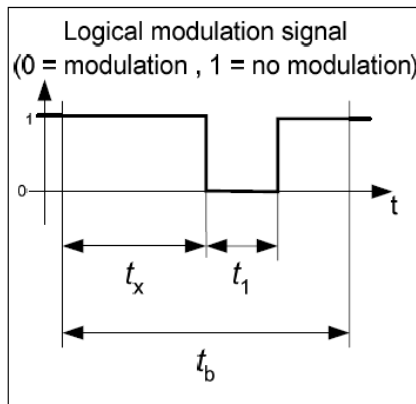

PauseA

ISO14443-2 , -3 for Type A

- The previously illustrated sequences are used to code the following:
 - logic "1": sequence X
 - logic "0": sequence Y with the following two exceptions:
 - i. If there are two or more contiguous "0"s, sequence Z shall be used from the second "0" on,
 - ii. If the first bit after a "start of communication" is "0", sequence Z shall be used to represent this and any "0"s which follow directly thereafter
- start of communication: sequence Z,
- end of communication: logic "0" followed by sequence Y
- no information: at least two sequences Y.

ISO14443A Analog Screen Captures

- These captures illustrate sequence X

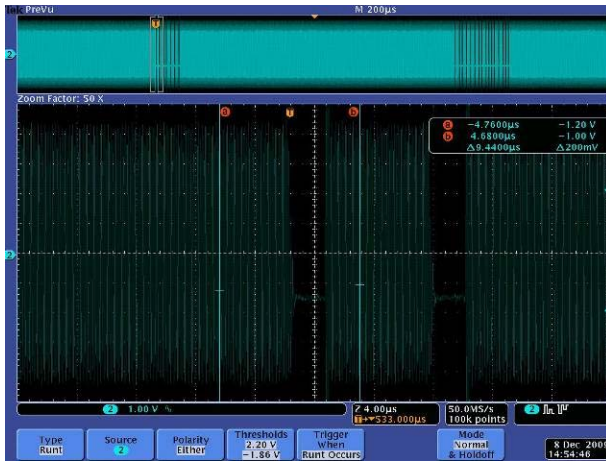

$$t_b = 9.44\mu\text{Sec}$$



$$t_x = 4.72\mu\text{Sec}$$



$$t_1 = 2.48\mu\text{Sec}$$

ISO14443A Analog Screen Captures

- These captures illustrate Sequences Y and Z

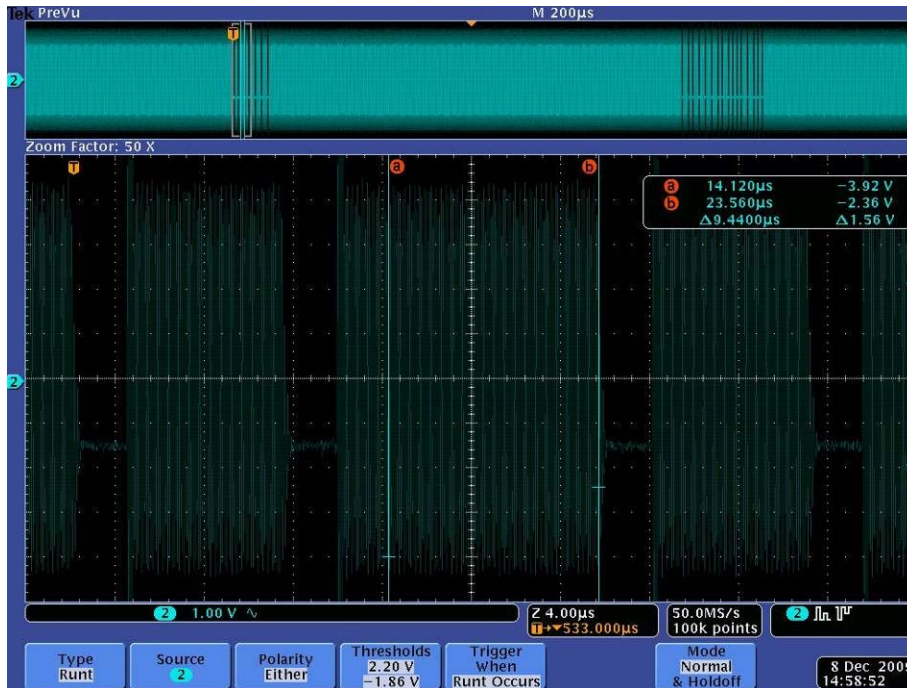

Sequence Y = Carrier for 9.44uSec



Sequence Z = Pause for 2uSec-3uSec,
Carrier for Remainder of 9.44uSec

ISO14443A Downlink Decoded Example

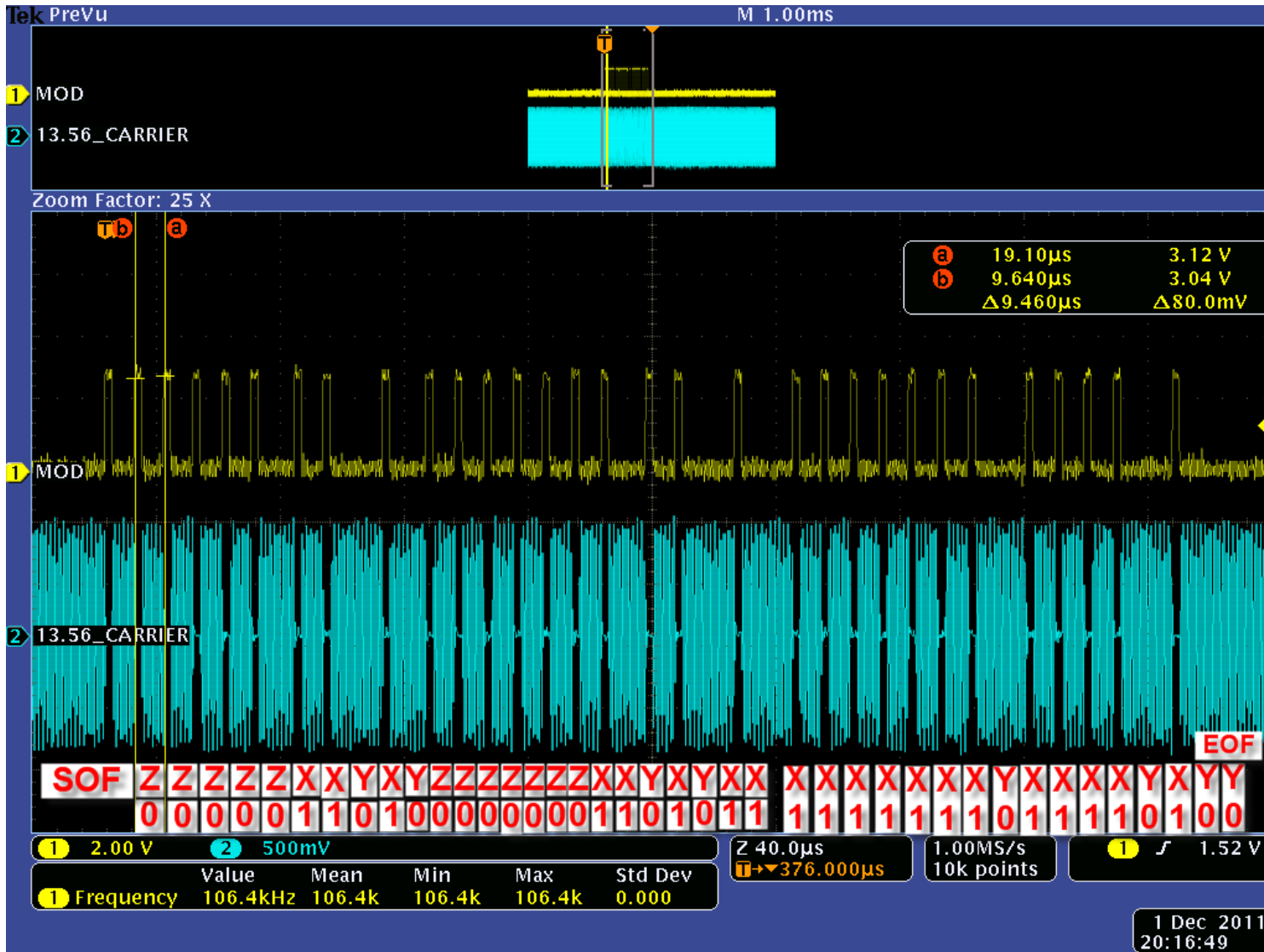

ISO14443-2 , -3 for Type A

- PICC to PCD communications uses load modulation on a subcarrier frequency of 848kHz (uplink)

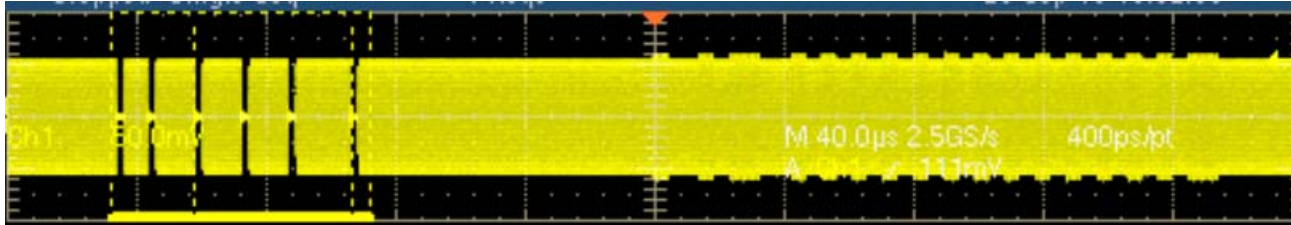

PCD DOWNLINK

PICC UPLINK

- Communications start at 106kbps and can be raised to 212kbps, 424kbps or 848kbps, if both sides (PCD and PICC support)
- For PICC Uplink, bit representations are defined and dependent upon the bit rates being used, the following sequences are defined for 106kbps (higher bit rates in standard) :
 - **sequence D**: the carrier shall be modulated with the subcarrier for the first half (50 %) of the bit duration
 - **sequence E**: the carrier shall be modulated with the subcarrier for the second half (50 %) of the bit duration
 - **sequence F**: the carrier is not modulated with the subcarrier for one bit duration

ISO14443-2 , -3 for Type A

- Bit coding shall be Manchester with the following definitions:
 - logic "1": sequence D
 - logic "0": sequence E
 - start of communication: sequence D
 - end of communication: sequence F
 - no information: no subcarrier

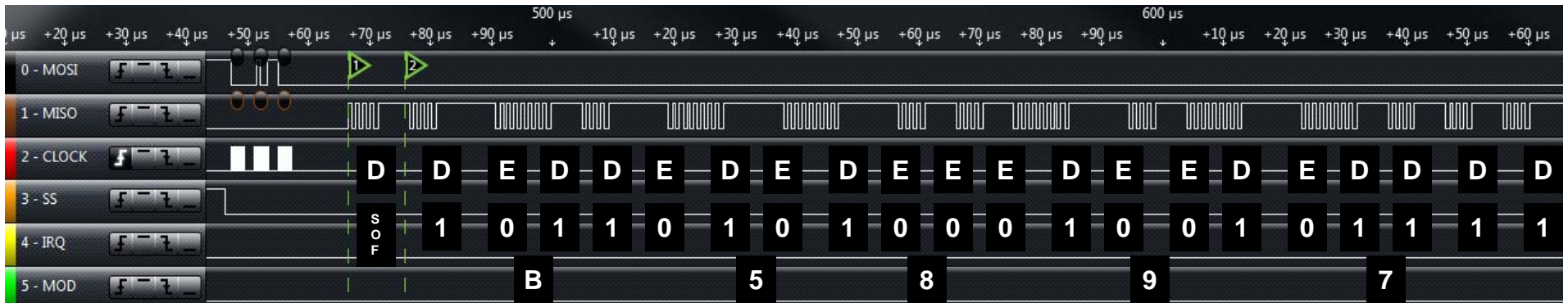

ISO14443-2 , -3 for Type A

- **ISO14443-3 Type A Command Set:**

- **REQA** (0x26) & **WUPA** (0x52)
 - These two commands are issued as broken byte (7 bits) command with no CRC
 - Used for Activation of the card
 - » REQA is activation command, WUPA is used after a HALTA.
 - PICC response is called ATQA (go to ISO14443-3, section 6.5.2 for details)
- **ANTICOLLISION & SELECT**
 - The anti-collision and selection for Type A is done inside a cascaded loop. (go to ISO14443-3, section 6.5.1 for details.)
 - The main output of this loop is the complete UID of the card, which can be 4, 7 or 10 bytes long. (called single, double or triple size UIDs)
- Cards which are not Layer 4 compliant are identified at end of this loop by their response.
 - B6 in **SAK** (go to Table 9 in ISO14443-3)
 - If card **is** compliant, proceed to -4 commands
 - Popular examples are: NFC Type 4A (MIFARE™ DESFire EV1) cards.
 - If card **is not** compliant, proceed to using that cards' specific document(s)
 - Popular examples are: NFC Type 2 (MFUL/MFULC) and MIFARE™ Classic cards.
 - » These card types are specifically covered in other training modules
- **HLTA** (0x50, 0x00, CRC_A)
 - Used to stop communication with the card while still in the PCD field (i.e. put it to sleep)

ISO14443-3 Activation and Selection Logic Loop (Type A)

Step 1	The PCD shall assign SEL with the code for the selected anticollision cascade level.
Step 2	The PCD shall assign NVB with the value of '20'. NOTE This value defines that the PCD will transmit no part of UID CL _n . Consequently this command forces all PICCs in the field to respond with their complete UID CL _n .
Step 3	The PCD shall transmit SEL and NVB.
Step 4	All PICCs in the field shall respond with their complete UID CL _n .
Step 5	If more than one PICC responds, a collision may occur. If no collision occurs, steps 6 to 10 shall be skipped.
Step 6	The PCD shall recognize the position of the first collision.
Step 7	The PCD shall assign NVB with a value that specifies the number of valid bits of UID CL _n . The valid bits shall be part of the UID CL _n that was received before a collision occurred followed by a (0)b or (1)b, decided by the PCD. A typical implementation adds a (1)b.
Step 8	The PCD shall transmit SEL and NVB, followed by the valid bits.
Step 9	Only PICCs of which the part of UID CL _n is equal to the valid bits transmitted by the PCD shall transmit their remaining bits of the UID CL _n .
Step 10	If further collisions occur, steps 6 to 9 shall be repeated. The maximum number of loops is 32.
Step 11	If no further collision occurs, the PCD shall assign NVB with the value of '70'. NOTE This value defines that the PCD will transmit the complete UID CL _n .
Step 12	The PCD shall transmit SEL and NVB, followed by all 40 bits of UID CL _n , followed by CRC_A.
Step 13	The PICCs which UID CL _n matches the 40 bits shall respond with their SAK.
Step 14	If the UID is complete, the PICC shall transmit SAK with cleared cascade bit and shall transit from READY state to ACTIVE state or from READY* state to ACTIVE* state.
Step 15	The PCD shall check if the cascade bit of SAK is set to decide whether further anticollision loops with increased cascade level shall follow.

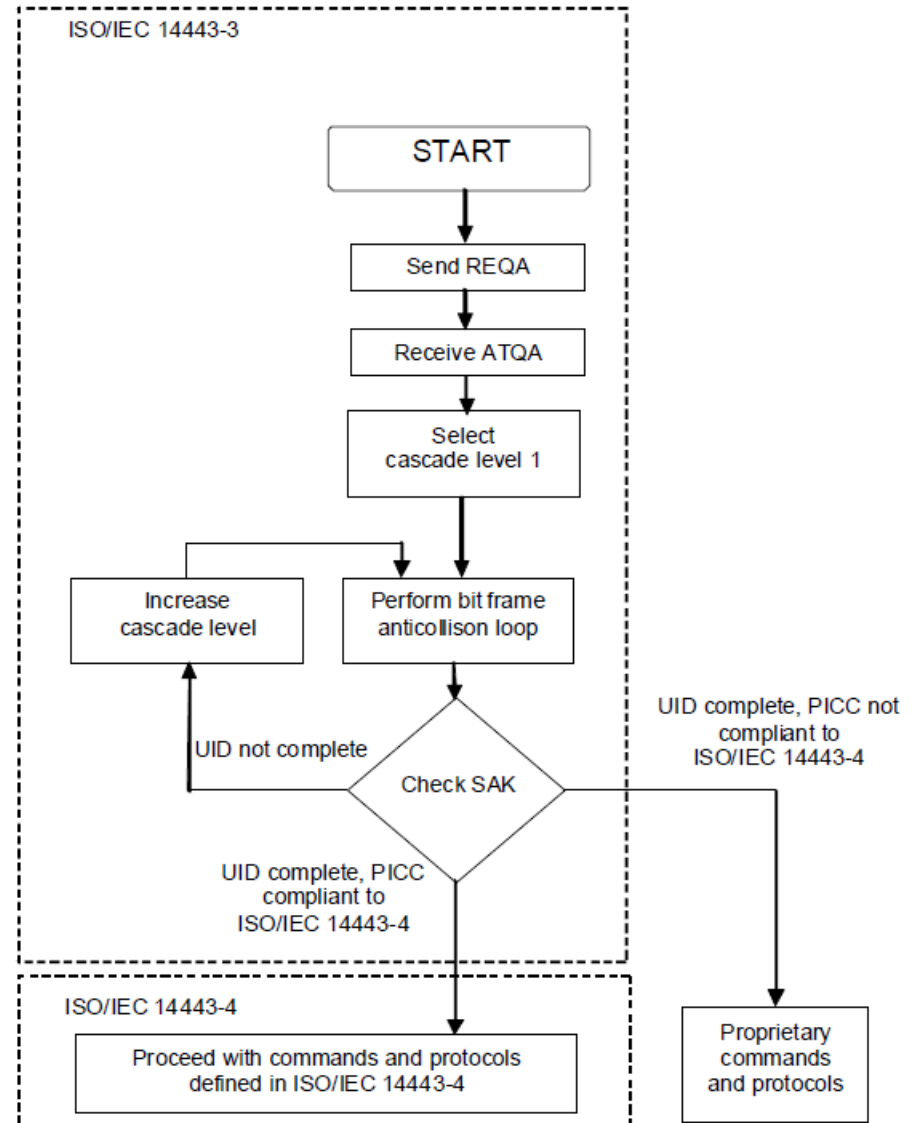

Going from ISO14443-3 into ISO14443-4A Logic Loop

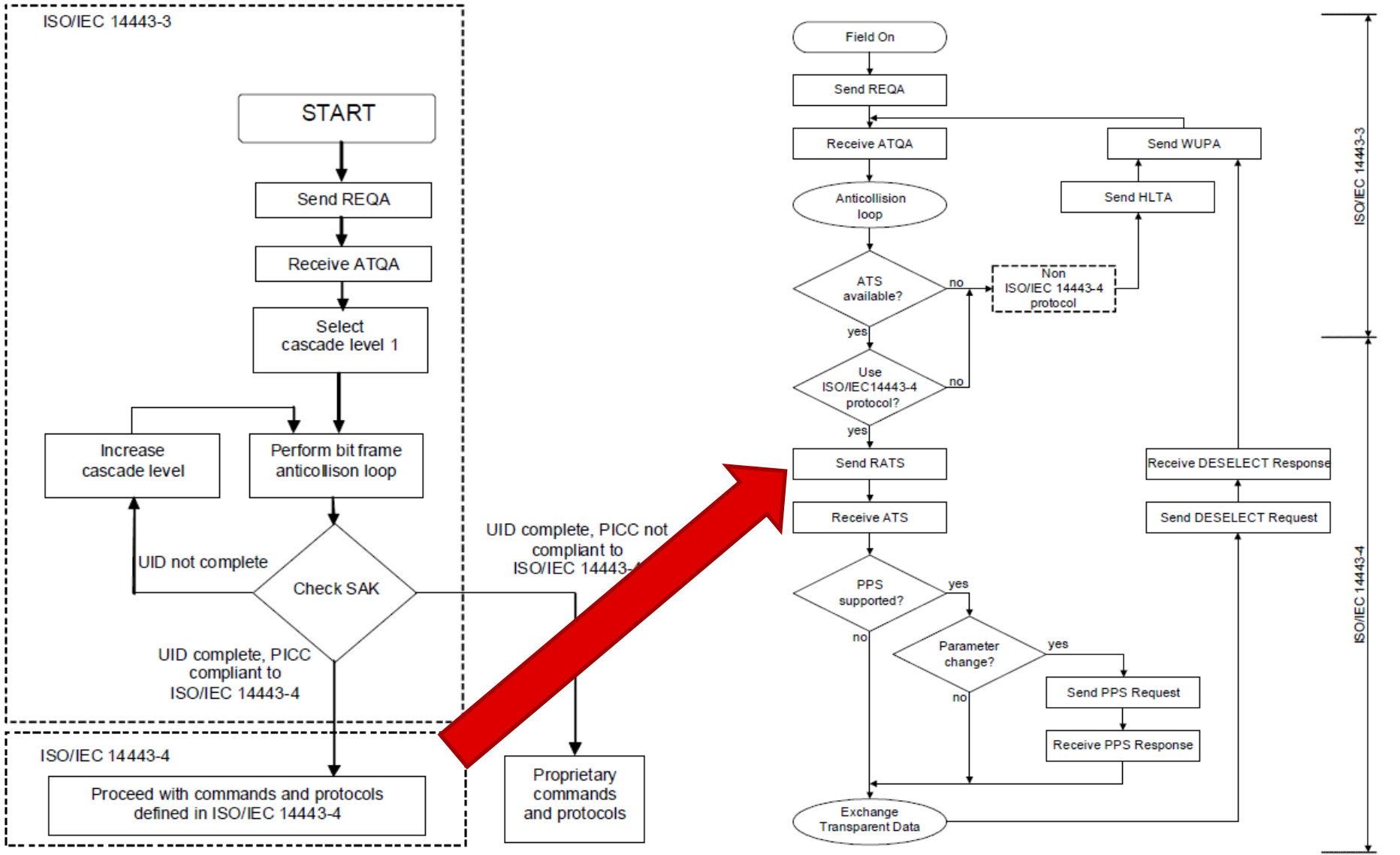

ISO14443-4 for Type A

- **Advanced Commands (used for -4, aka “Layer 4” compliant cards)**
 - **RATS** (used to select a -4 compliant card)
 - Response is Answer to Select (**ATS**)
 - **PPS** (optional command used to change data rate, issued after **RATS/ATS** command/response)
- After Layer 4 is entered, commands and protocols are used to exchange data transparently.
 - This is the Data Link (MAC + LLC) & Application layers shown previously as represented in the OSI model concept.
 - ISO14443-4 provides a “framework structure” and scenario handling rules for these layers, ISO17816-4 provides Commands and Error Codes
 - Together, ISO14443-4 + ISO7816-4 make no distinction between Type A or Type B, data is sent or received according to the same protocol rules for both cards types in this layer.
 - Details on Type 4A and Type 4B data/error handling will be covered in detail inside another training module of this series.

Chaining Data in ISO14443-4 for both Types (A & B)

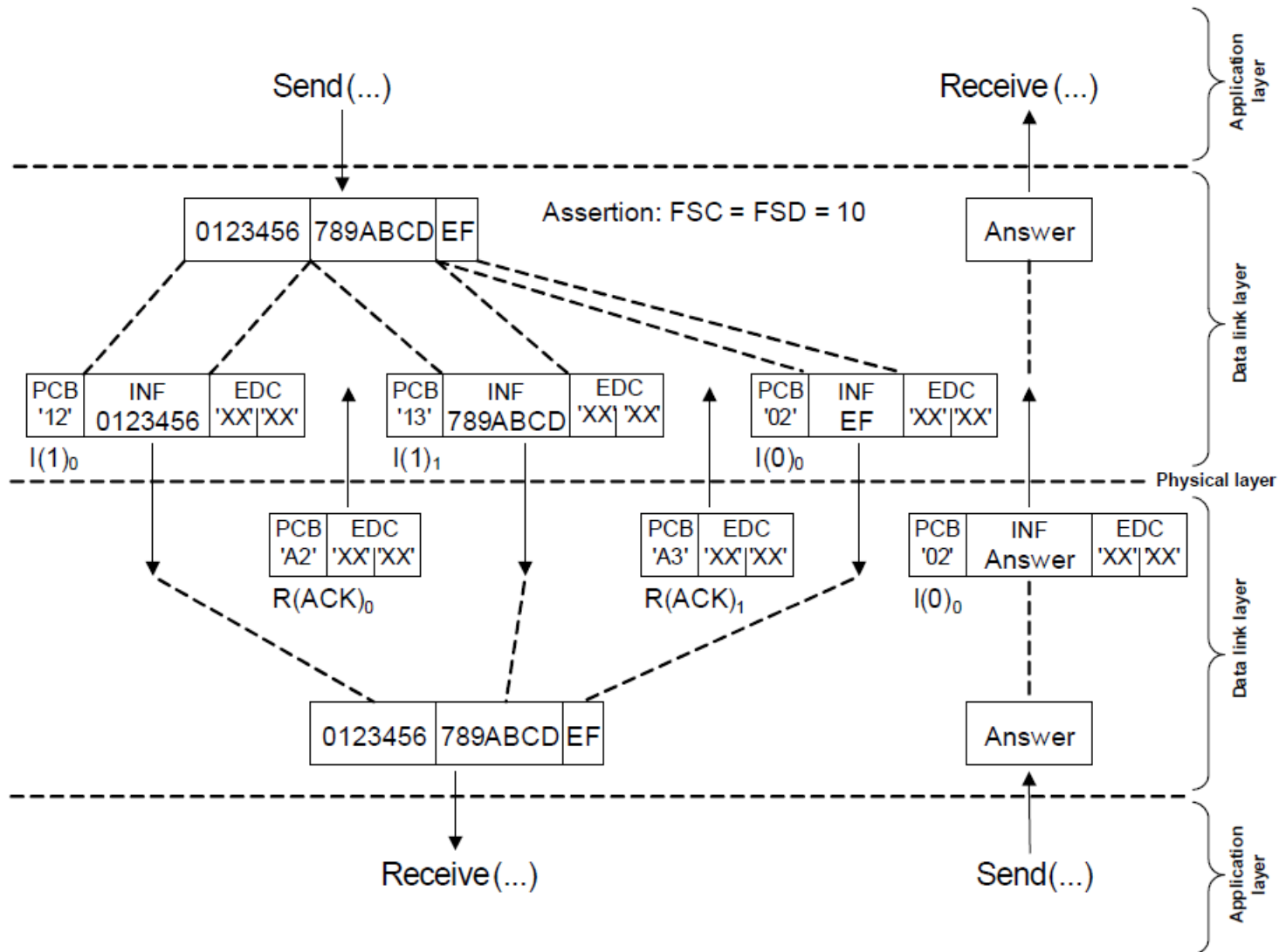

Test Standards for ISO14443

- **ISO10373-6 used for test standard**

- This part of ISO/IEC 10373 defines test methods which are specific to proximity cards and objects, and proximity coupling devices, defined in ISO/IEC 14443-1:2008, ISO/IEC 14443-2:2010, ISO/IEC 14443-3:2010 and ISO/IEC 14443-4:2008

- Both EMVCo and NFC Forum both have used ISO10373-6 as the basis for their testing specifications, but have added significant / made adaptations to this standard in order to fit their application viewpoint.

ISO14443B

ISO14443-2 , -3 for Type B

- **Air Interface Protocol –**

- Uses 10% Amplitude Shift Key (ASK) for PCD to PICC communications (downlink)
- The downlink is using NRZ, in which logic levels are defined as follows:
 - logic "1": carrier high field amplitude (no modulation applied)
 - logic "0": carrier low field amplitude

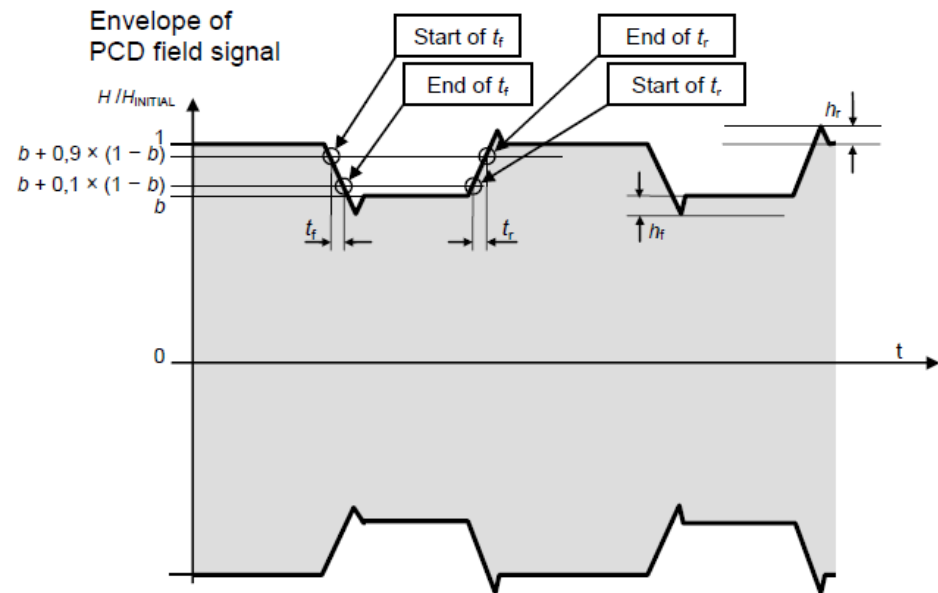
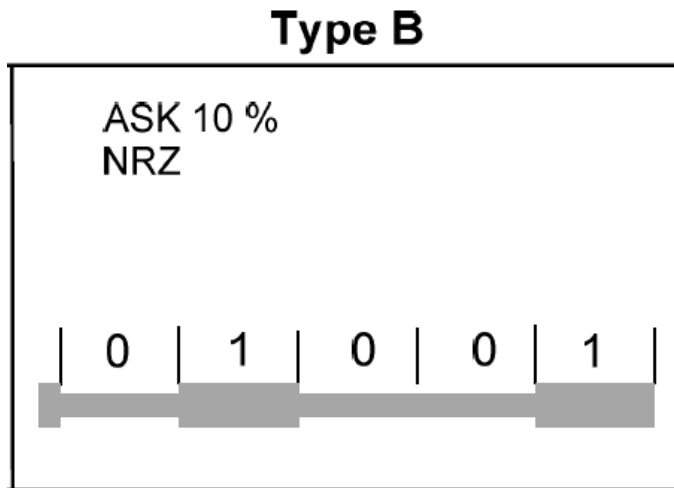

ISO14443B Analog Screen Captures

- These captures illustrate NRZ sequences for the PCD downlink protocol

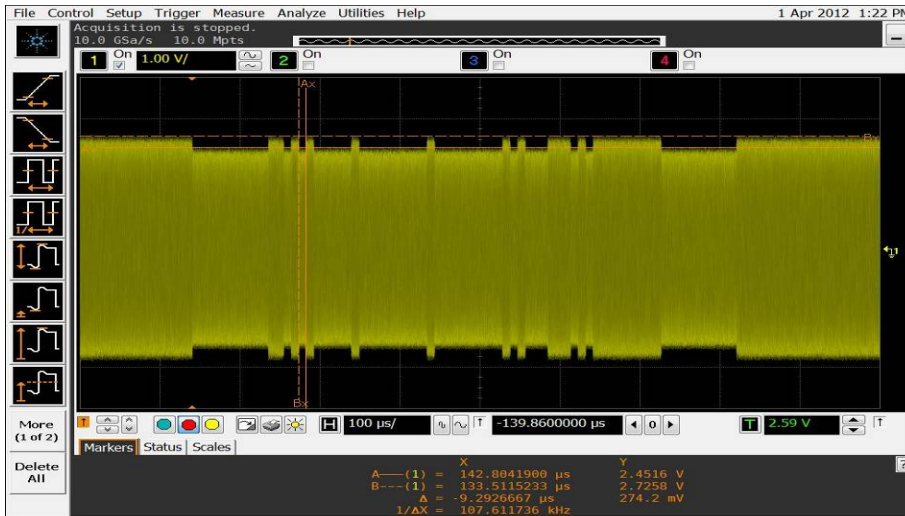

ISO14443B, 10% Modulation
Depth Overall Capture

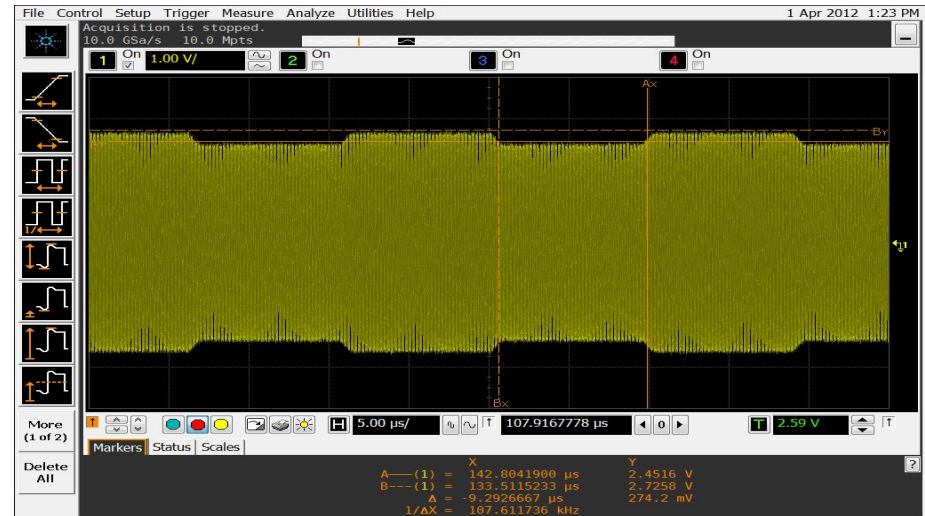

ISO14443B, 10% Modulation
Depth Zoom

ISO14443-2 , -3 for Type B

- **Air Interface Protocol –**

- PICC to PCD communications uses load modulation on a subcarrier frequency of 848kHz (uplink)
 - Communications start at 106kbps and can be raised to 212kbps, 424kbps or 848kbps, if both sides (PCD and PICC support)
 - The subcarrier is BPSK modulated. Phase shifts shall only occur at nominal positions of rising or falling edges of the subcarrier and bit coding shall be NRZ-L where a change of logic level shall be denoted by a phase shift (180°) of the subcarrier.
- The initial logic level for NRZ-L at the start of a PICC frame shall be established by the following sequence:
 - After any command from the PCD a guard time TR0 shall apply in which the PICC shall not generate a subcarrier. TR0 shall be greater than $64/f_s$ ($\sim 75.5\mu\text{s}$).
 - The PICC shall then generate a subcarrier with no phase transition for a synchronization time TR1. This establishes an initial subcarrier phase reference $\emptyset 0$. TR1 shall be greater than $80/f_s$ ($\sim 94.4\mu\text{s}$).
 - This initial phase state $\emptyset 0$ of the subcarrier shall be defined as logic "1" so that the first phase transition represents a change from logic "1" to logic "0".
 - Subsequently, the logic level is defined according to the initial phase of the subcarrier.
 - $\emptyset 0$: represents logic "1"
 - $\emptyset 0 + 180^\circ$: represents a logic "0".

ISO14443B PICC Response

- This illustration shows expected BPSK NRZ-L uplink logic level sequences from the PICC.

Type B

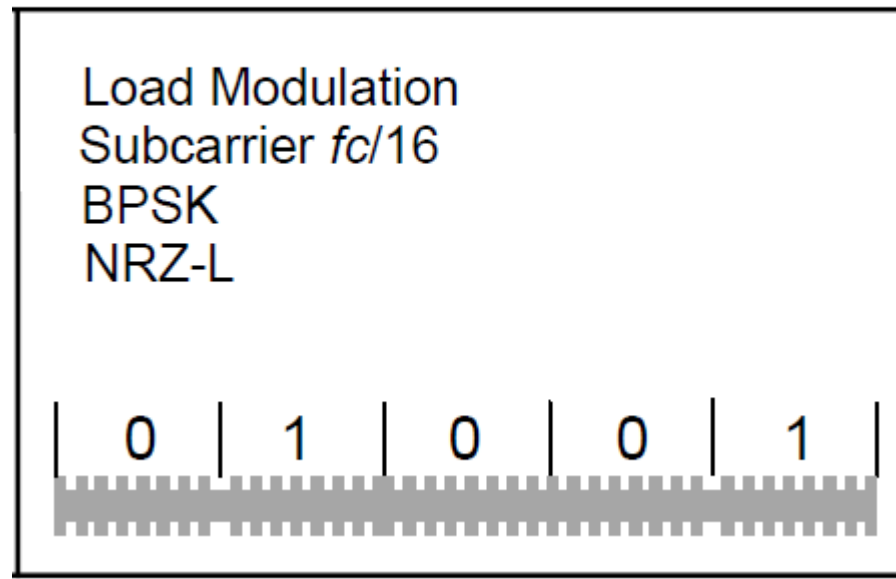

ISO14443-2 , -3 for Type B

- **ISO14443-3 Type B Command Set:**

- More efficient than ISO14443A, only four primitive commands are needed to manage the multi-node communication channels in this sub-protocol of ISO14443:
- **REQB & WUPB**
 - The REQB and WUPB Commands sent by the PCD are used to probe the field for PICCs of Type B. In addition, WUPB is particularly used to also wake up PICCs which are in HALT state.

1 st byte	2 nd byte	3 rd byte	4 th , 5 th bytes
APf (1 byte)	AFI (1 byte)	PARAM (1 byte).	CRC_B (2 bytes)
MSB	LSB MSB	LSB MSB	LSB MSB

- Response is called: Answer to Request B (ATQB)
- Inside the ATQB response is the PUPI, Application and Protocol Data Bytes

1 st byte	2 nd , 3 rd , 4 th , 5 th bytes	6 th , 7 th , 8 th , 9 th , bytes	10 th , 11 th , 12 th , bytes	13 th , 14 th bytes
'50' (1 byte)	PUPI (4 bytes)	Application Data (4 bytes)	Protocol Info (3 bytes)	CRC_B (2 bytes)
MSB	LSB MSB	LSB MSB	LSB MSB	LSB

ISO14443-2 , -3 for Type B

- **ISO14443-3 Type B Command Set (cont.):**

- **ATTRIB**

- The ATTRIB Command sent by the PCD includes information required to select a single PICC.
- A PICC receiving an ATTRIB Command with its identifier becomes selected and assigned to a dedicated channel. After being selected, this PICC only responds to commands defined in ISO/IEC 14443-4 which include its unique CID.
- This command is also used to change data rate of the PCD \leftrightarrow PICC communications.

1 st byte	2 nd , 3 rd , 4 th , 5 th bytes	6 th byte	7 th byte	8 th byte	9 th byte	10 th ,bytes	
'1D' (1 byte)	Identifier (4 bytes)	Param 1 (1 byte)	Param 2 (1 byte)	Param 3 (1 byte)	Param 4 (1 byte)	Higher layer - INF (optional – 0 or more bytes)	CRC_B (2 bytes)
MSB LSB	MSB LSB MSB LSB MSB LSB	MSB LSB	MSB LSB	MSB LSB	MSB LSB	MSB LSB MSB LSB MSB LSB MSB LSB	MSB LSB MSB LSB

- If the higher layer INF field in the command request is empty (normal), then the Answer to ATTRIB response will be:

1 st byte		2 nd , 3 rd bytes	
MBLI	CID	CRC_B	
(1 byte)		(2 bytes)	
MSB	LSB	MSB	LSB

- When this response is received, the card will be in Layer 4 and ready for transparent data exchange.

ISO14443-2 , -3 for Type B

- **ISO14443-3 Type B Command Set (cont.):**

- **Slot-MARKER**

- After a REQB/WUPB Command, the PCD may send up to (N-1) Slot-MARKER Commands to define the start of each timeslot. (it's not mandatory, like Type A)
 - Slot-MARKER Commands can be sent :
 - » after the end of an ATQB message received by the PCD to mark the start of the next slot or earlier if no ATQB is received (no need to wait until the end of a slot, if this slot is known to be empty).
 - » It is not mandatory for a PICC to support this command. In this case, the PICC shall ignore any Slot-MARKER Command. The PICC may only send its ATQB after REQB (in the first slot) in a probabilistic approach.

- **HLTB**

- The HLTB Command is used to set a PICC in HALT state and stop responding to a REQB. After answering to this command the PICC shall ignore any commands except the WUPB Command.
- The four byte Identifier is the PUPI, retrieved from the REQB command.

1 st byte	2 nd , 3 rd , 4 th , 5 th bytes	6 th , 7 th bytes
'50' (1 byte)	Identifier (4 bytes)	CRC_B (2 bytes)
MSB LSB	MSB LSB	MSB LSB

ISO14443-3 Activation and Selection Logic Loop (Type B)

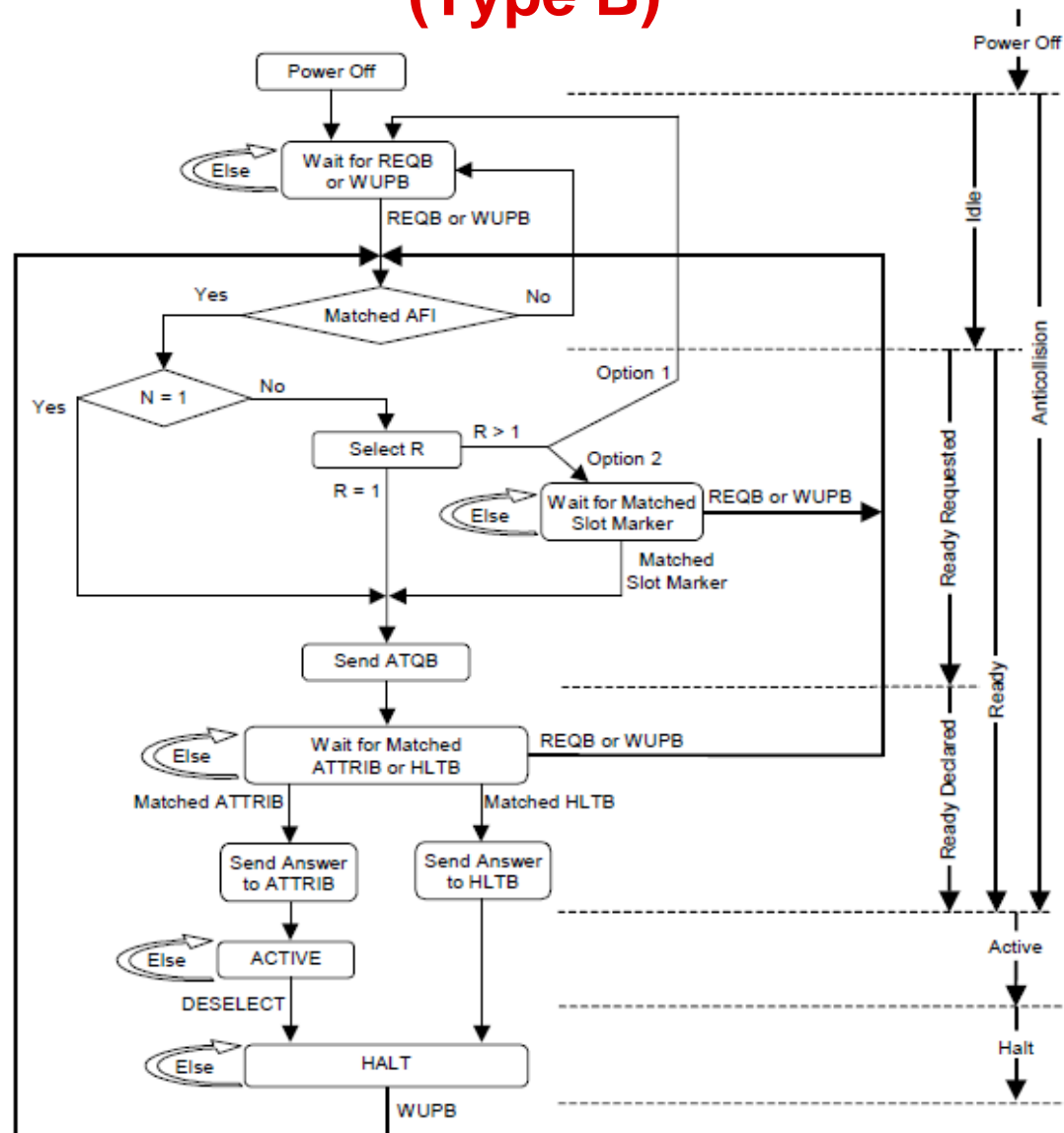

ISO14443-4 for Type B

- After Layer 4 is entered, commands and protocols are used to exchange data transparently.
 - This is the Data Link (MAC + LLC) & Application layers shown previously as represented in the OSI model concept.
 - ISO14443-4 provides a “framework structure” and scenario handling rules for these layers, ISO17816-4 provides Commands and Error Codes
 - Together, ISO14443-4 + ISO7816-4 make no distinction between Type A or Type B, data is sent or received according to the same protocol rules for both cards types in this layer.
 - Details on Type 4A and Type 4B data/error handling will be covered in detail inside another training module of this series. Below is the block format used in Layer 4.

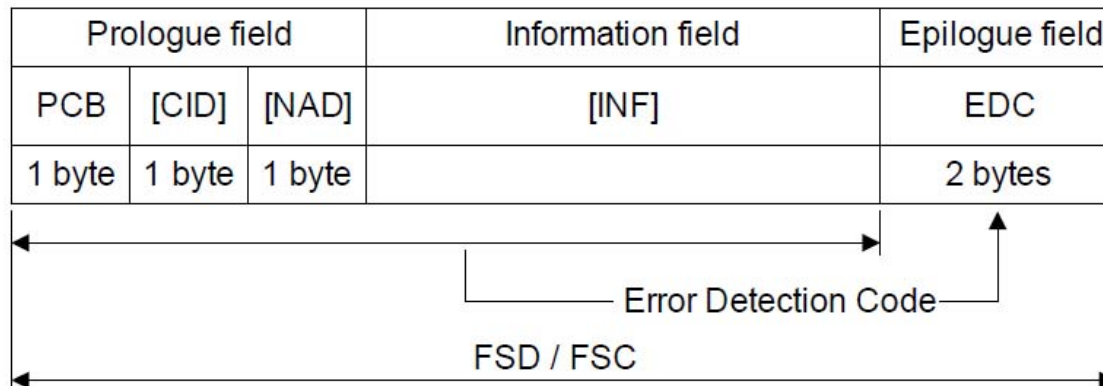

NOTE The items in brackets indicate optional requirements.

Chaining Data in ISO14443-4 for both Types (A & B)

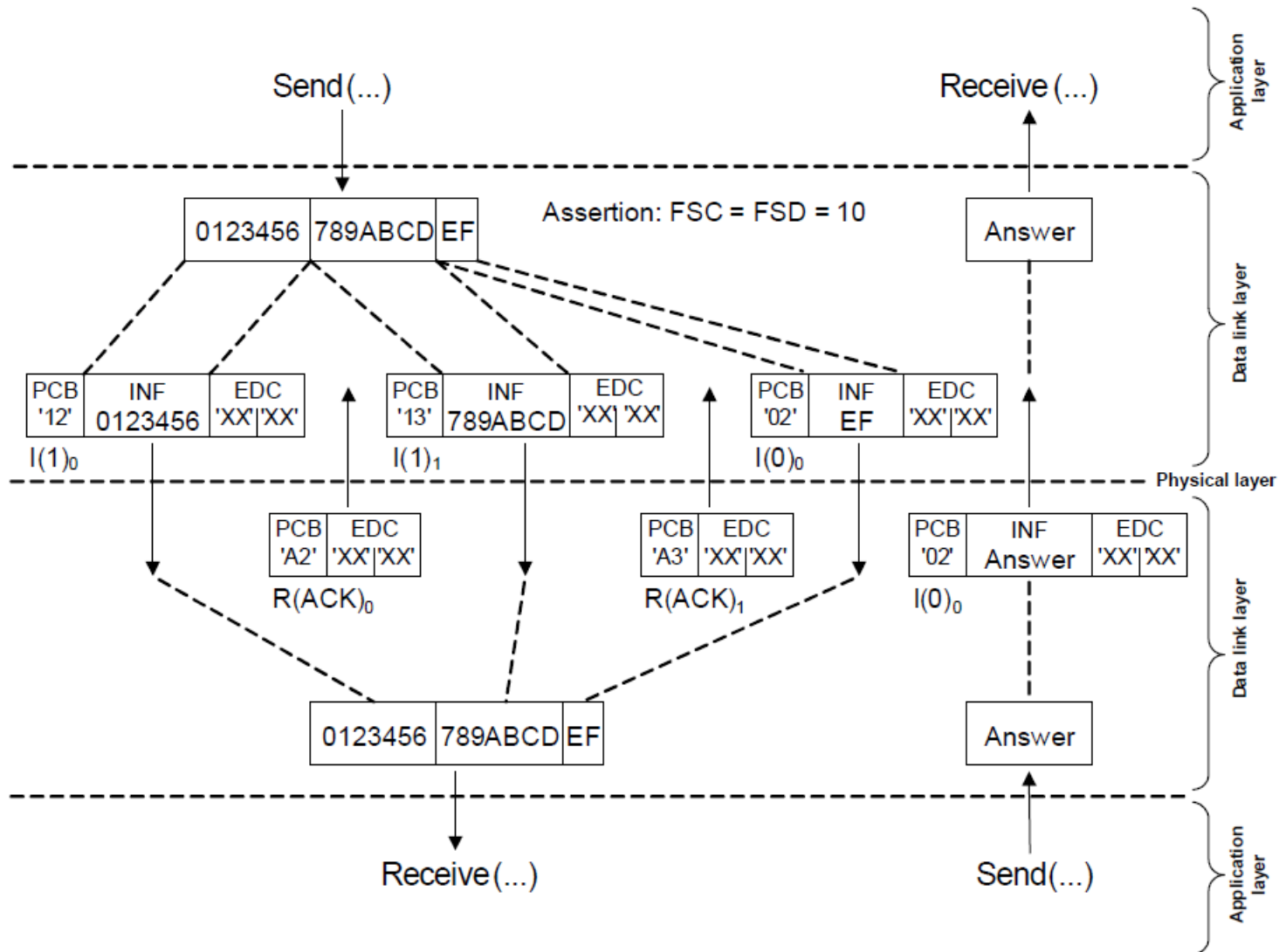

Test Standards for ISO14443

- **ISO10373-6 used for test standard**
 - This part of ISO/IEC 10373 defines test methods which are specific to proximity cards and objects, and proximity coupling devices, defined in ISO/IEC 14443-1:2008, ISO/IEC 14443-2:2010, ISO/IEC 14443-3:2010 and ISO/IEC 14443-4:2008
- Both EMVCo and NFC Forum both have used ISO10373-6 as the basis for their testing specifications, but have added significant / made adaptations to this standard in order to fit their application viewpoint.

ISO15693

HF RFID ISO Standards Overview (cont.)

- **ISO/IEC 15693** is primarily used for **Vicinity Applications**
 - Access Control, Asset Tracking, Portable Data Storage, etc.
 - ISO15693 is logically divided into 3 parts
 - ISO15693-1 : Physical Characteristics of Cards (**VICCs**)
 - ISO15693-2 : Air Interface and Initialization
 - ISO15693-3 : Anti-Collision and Transmission Protocol
 - **NOTE:** ISO/IEC 18000-3 is medical application version of ISO15693

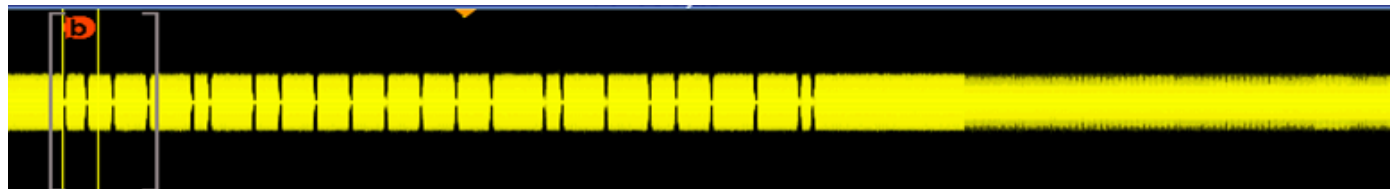
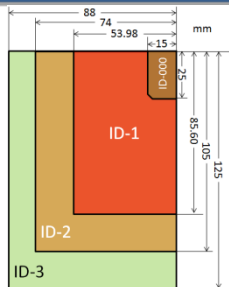

ISO15693-2

- Air Interface Protocol – Downlink**

- Uses either 100% or 10-30% Amplitude Shift Key (ASK) for PCD to PICC (downlink)

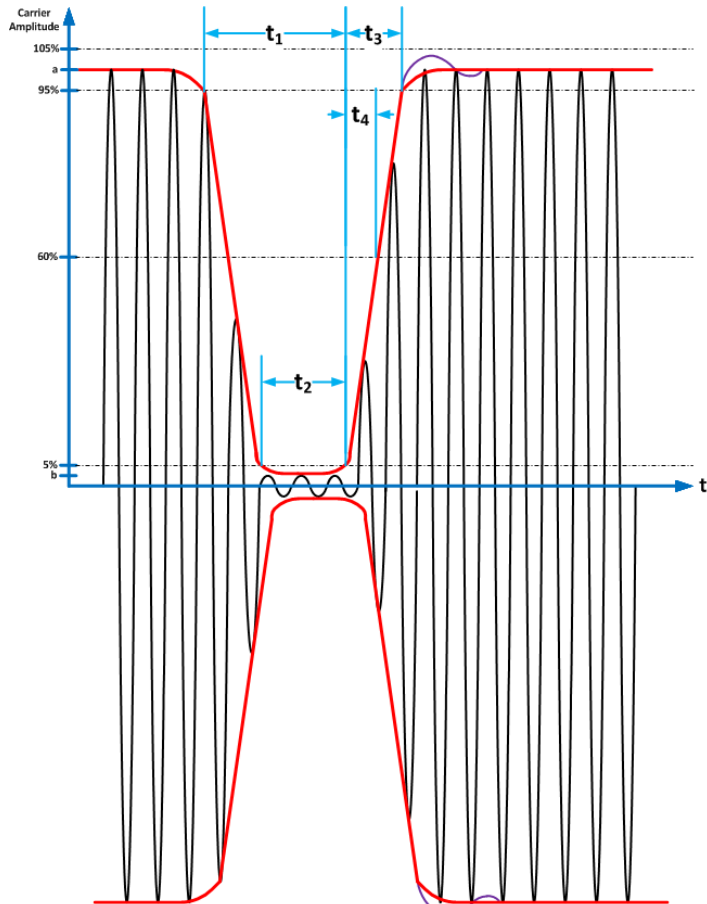

The clock recovery must be operational after t_4 max

NOTE: CARRIER WAVE IS ACTUALLY 13.56MHz, REPRESENTED HERE JUST AS SINE WAVE TO SHOW TYPE OF SIGNAL

	min (uSec)	max (uSec)
t_1	6.0	9.44
t_2	2.1	t_1
t_3	0	4.5
t_4	0	0.8

Figure 1 – Modulation of the carrier for 100% ASK

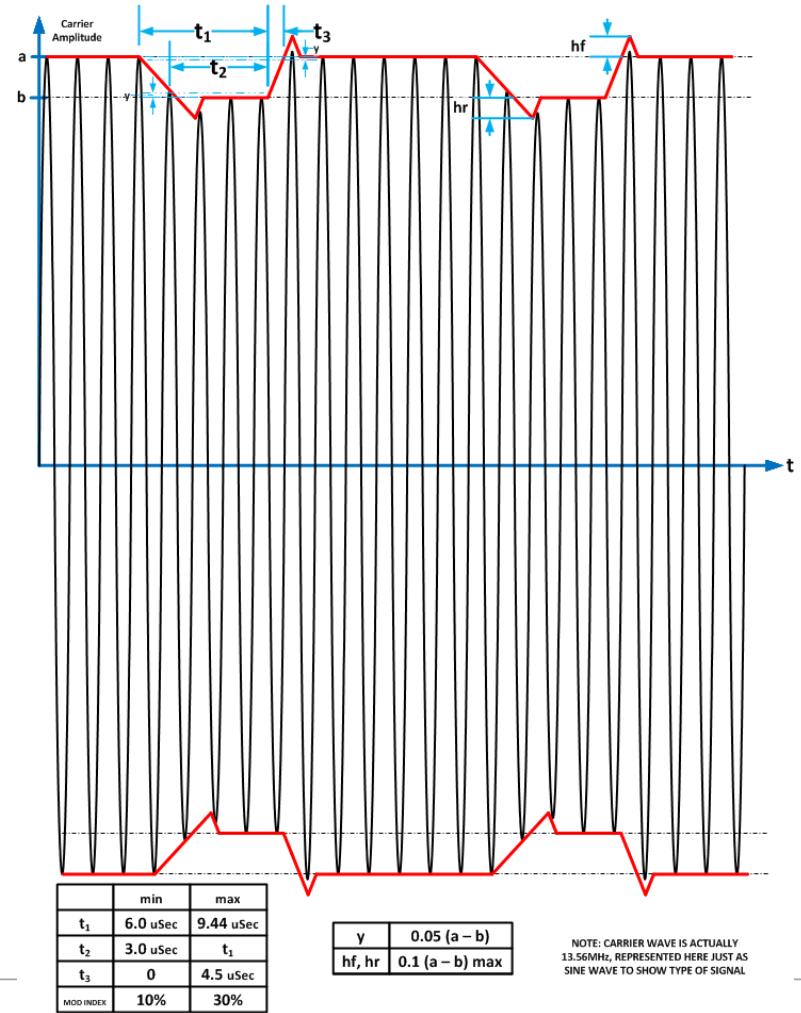

	min	max
t_1	6.0 uSec	9.44 uSec
t_2	3.0 uSec	t_1
t_3	0	4.5 uSec
MOD INDEX	10%	30%

y	$0.05(a - b)$
hf, hr	$0.1(a - b)$ max

NOTE: CARRIER WAVE IS ACTUALLY 13.56MHz, REPRESENTED HERE JUST AS SINE WAVE TO SHOW TYPE OF SIGNAL

The VICC shall be operational for any value of modulation index between 10% and 30%

Figure 2 – Modulation of the carrier for 10% ASK

ISO15693-2 Important Timings (Downlink)

- Start of Frame (SOF)

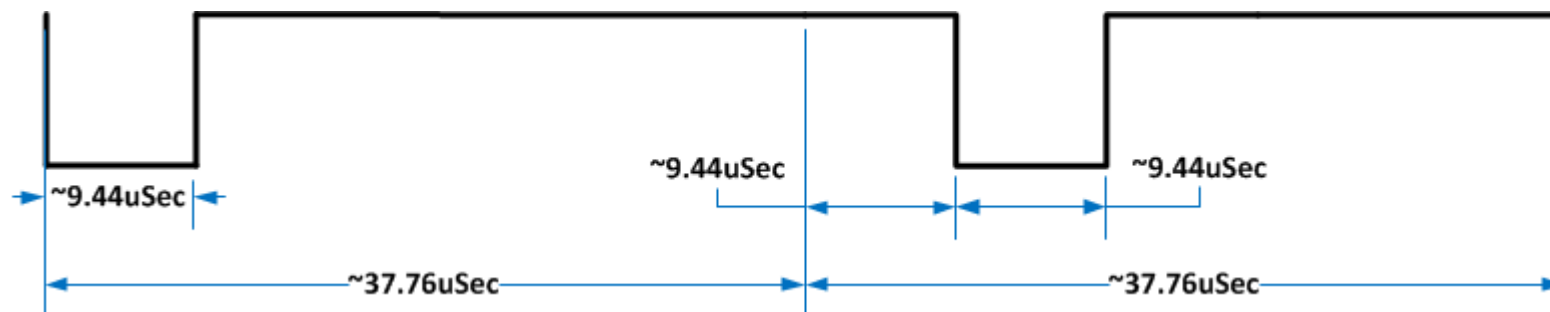

- End of Frame (EOF)

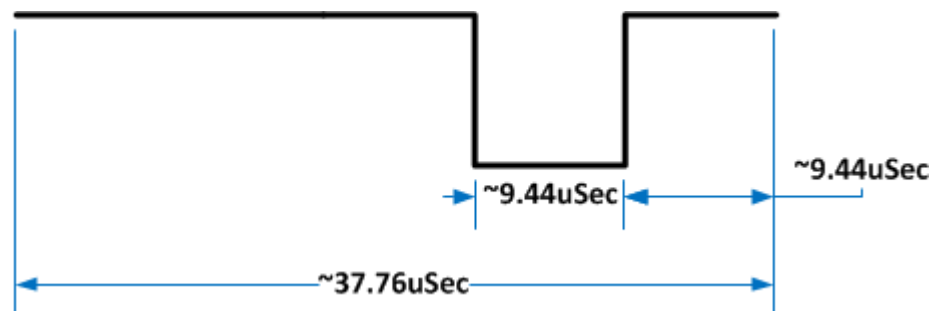

ISO15693-2 Important Downlink Timings (cont.)

- Symbols 00, 01, 10, 11
 - Pulse Position Modulation Technique is used here, where the position determines two bits at a time.

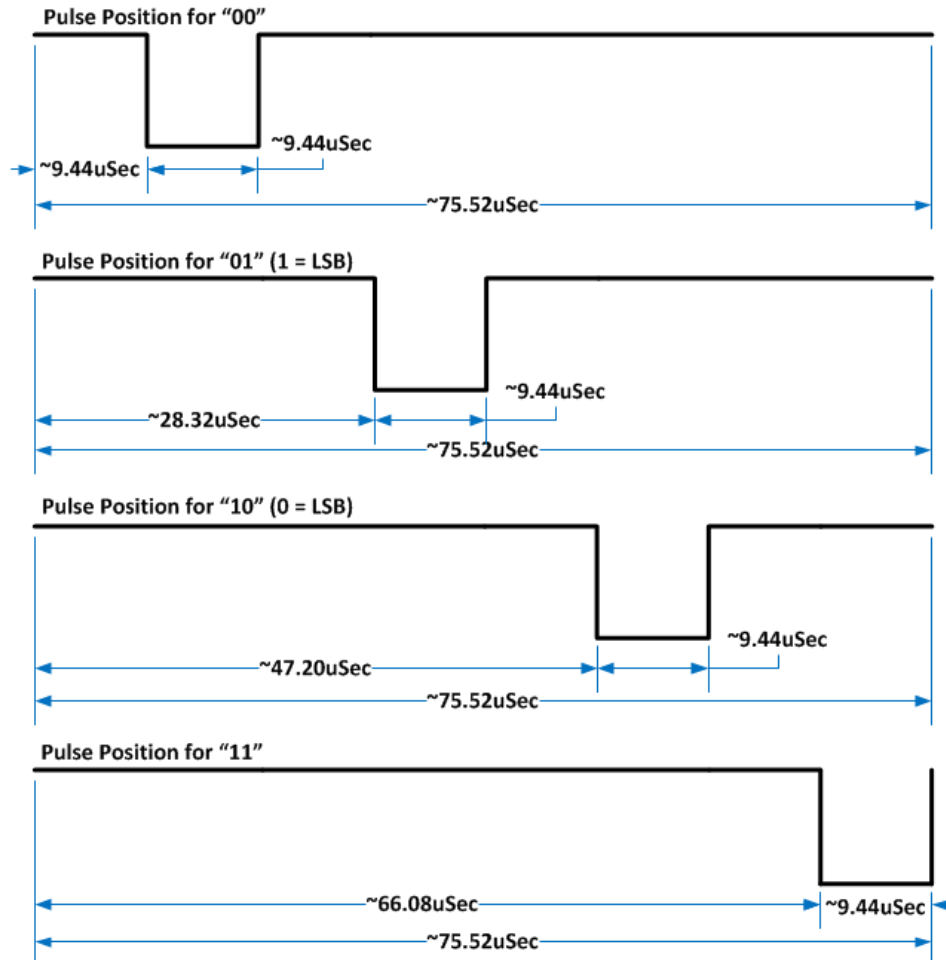

This is showing one complete byte
(0xE1) for transmission

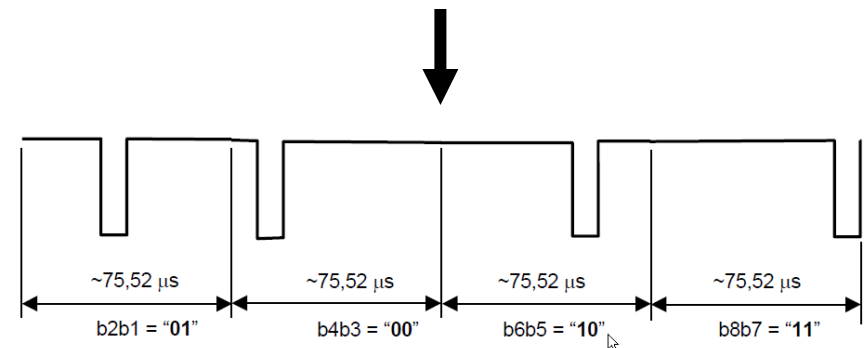

ISO15693 Downlink Start of Frame (SOF)

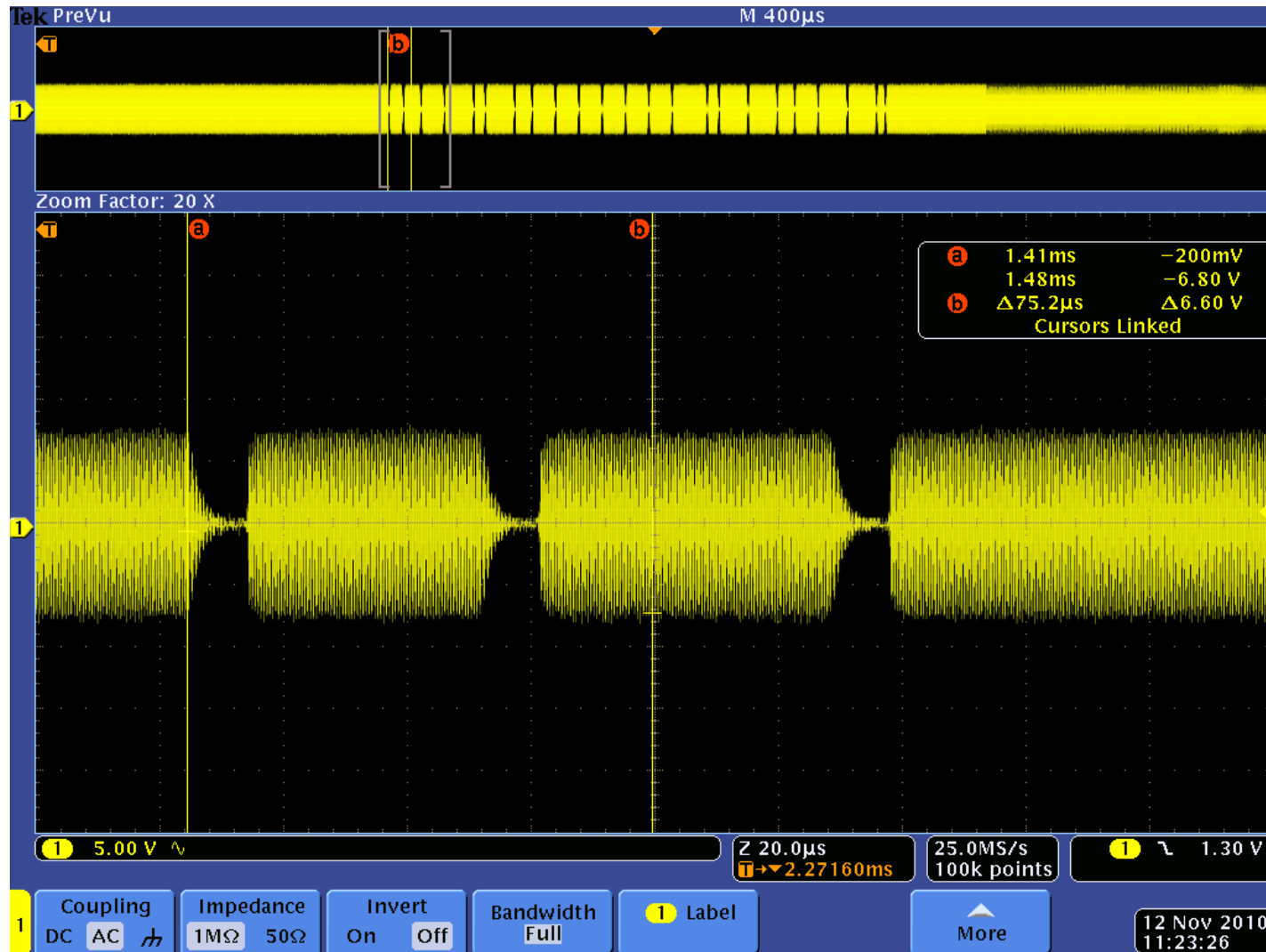

ISO15693 Downlink Symbol 00

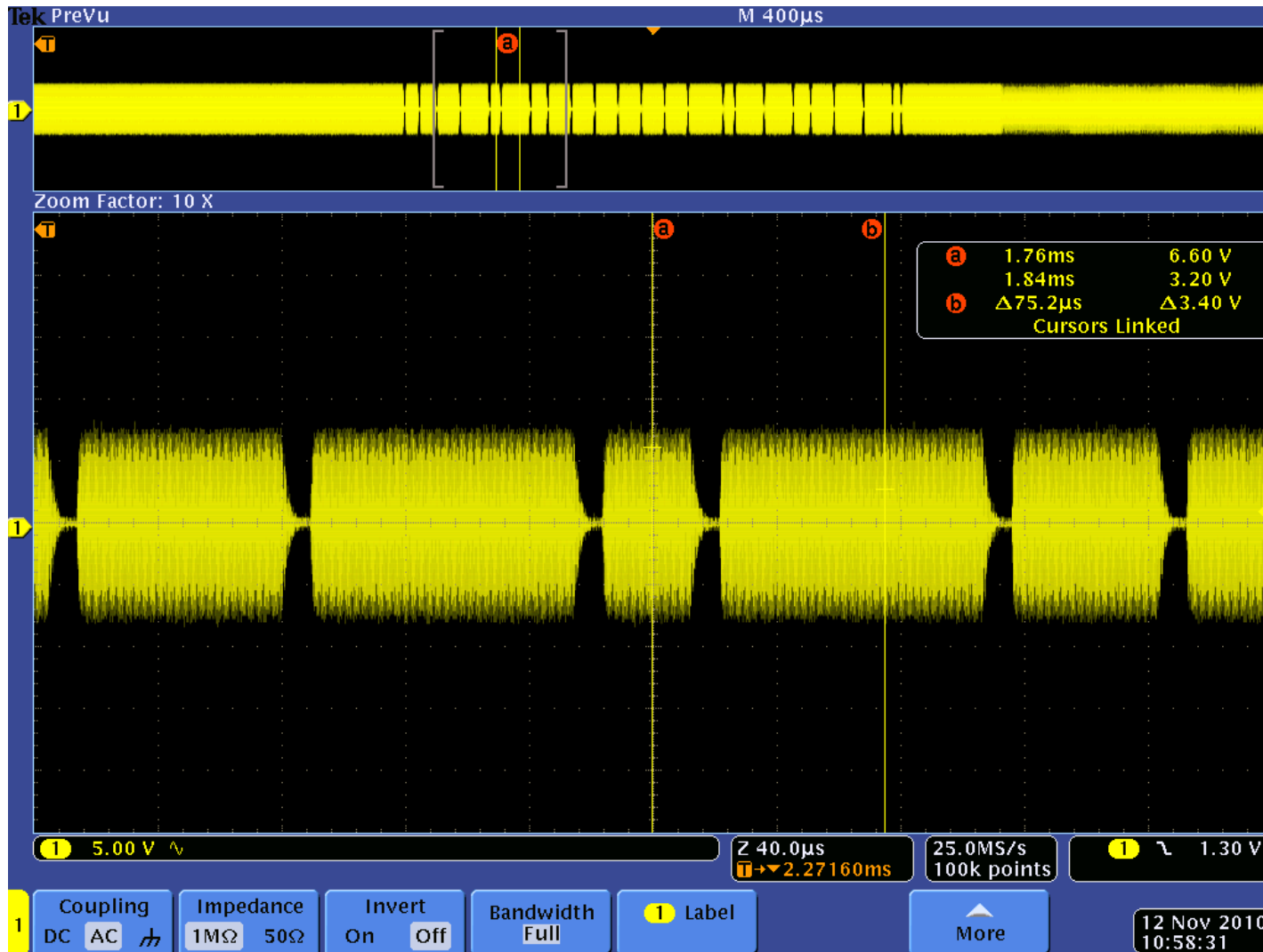

ISO15693 Downlink Symbol 01

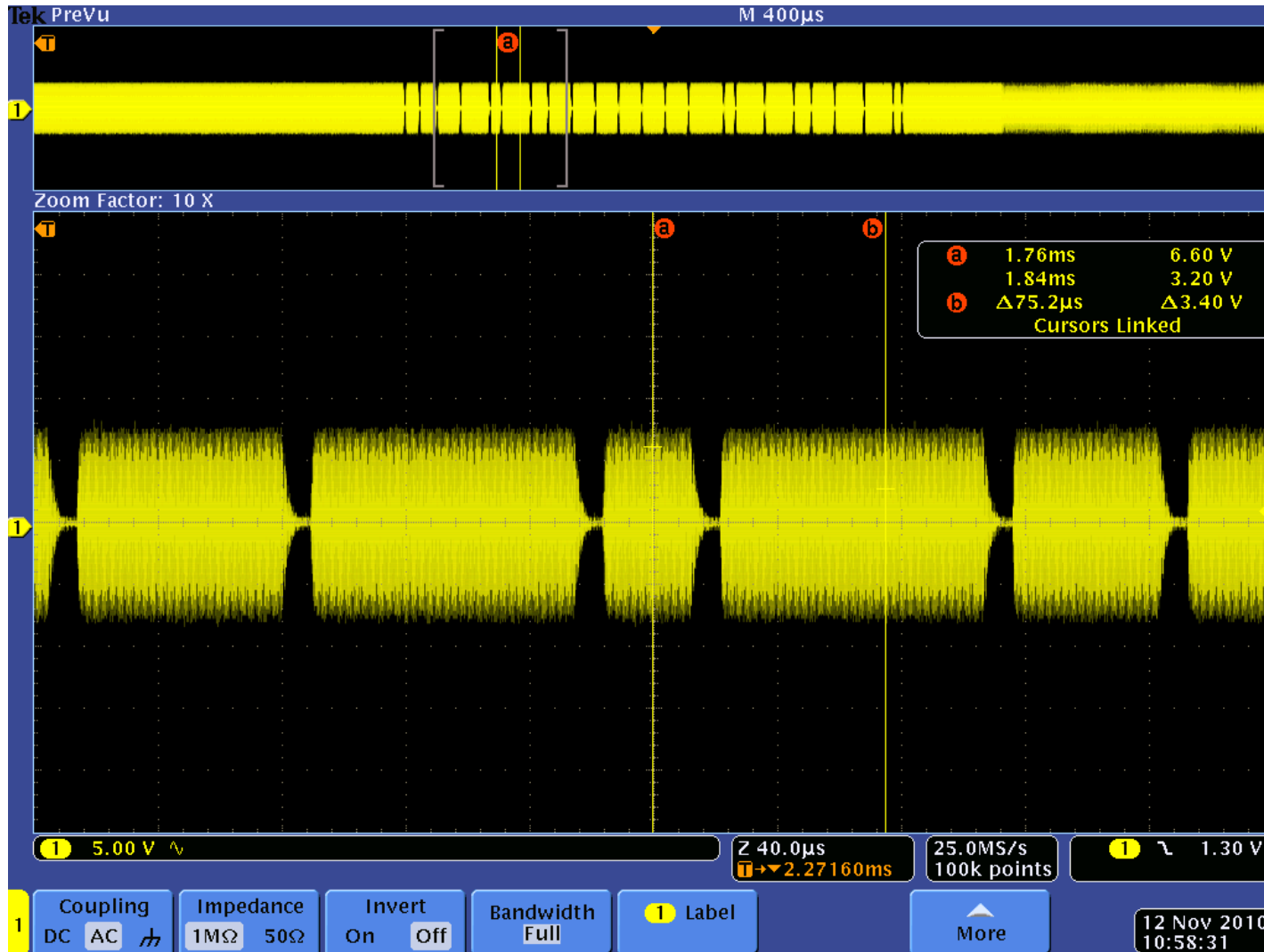

ISO15693 Downlink Symbol 10

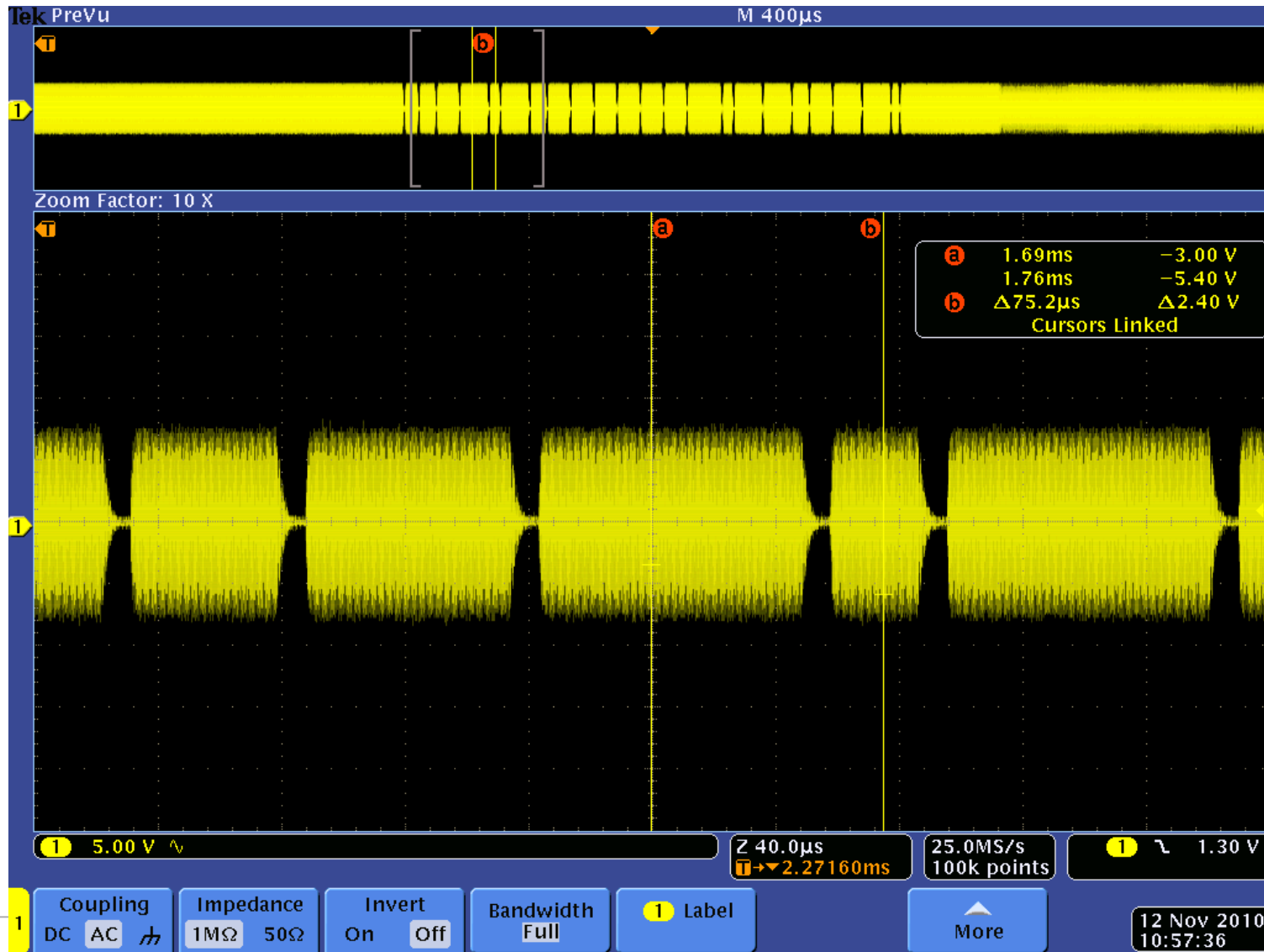

ISO15693 Downlink Symbol 11

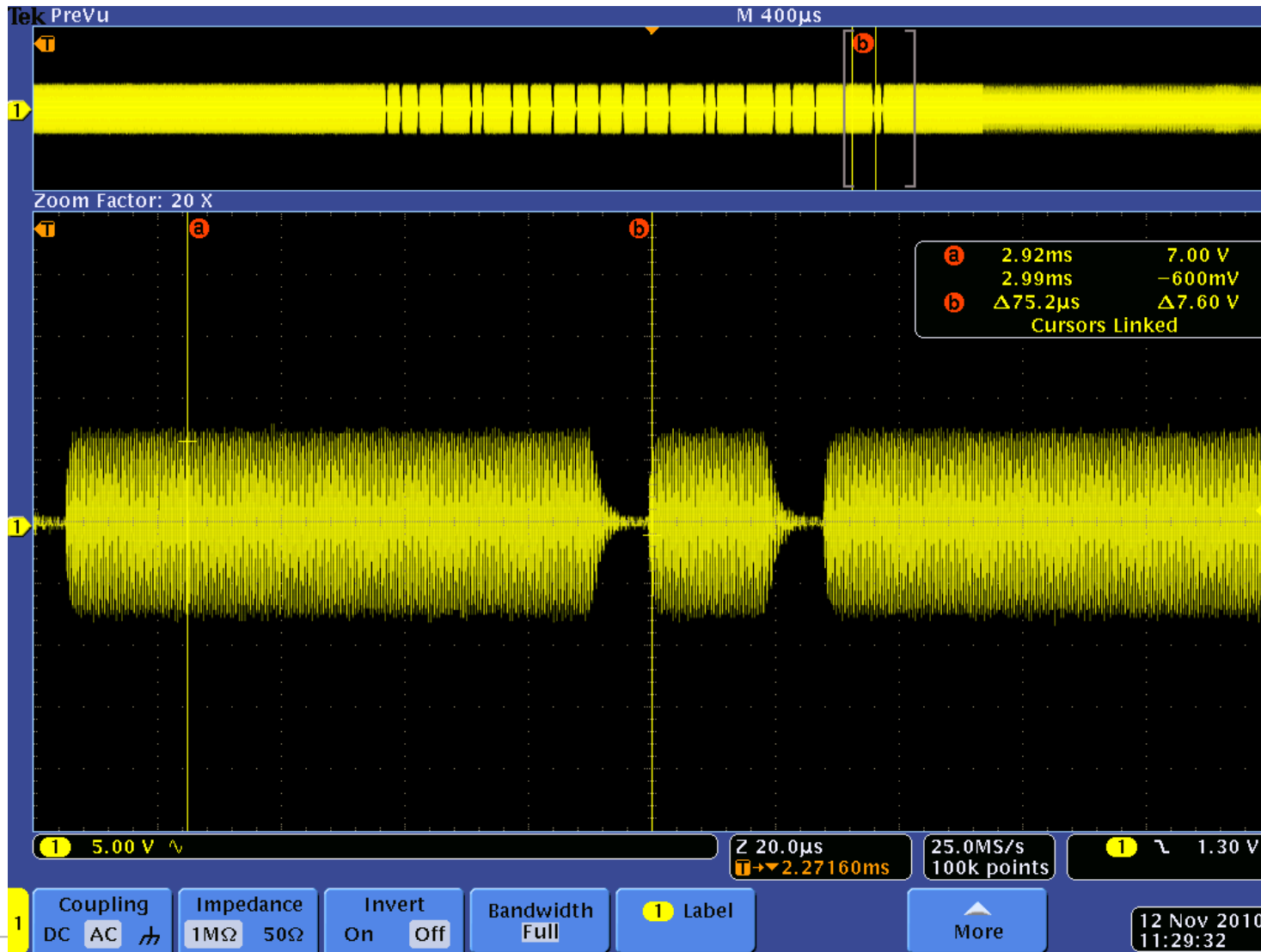

TEXAS INSTRUMENTS

ISO15693 Downlink End of Frame (EOF)

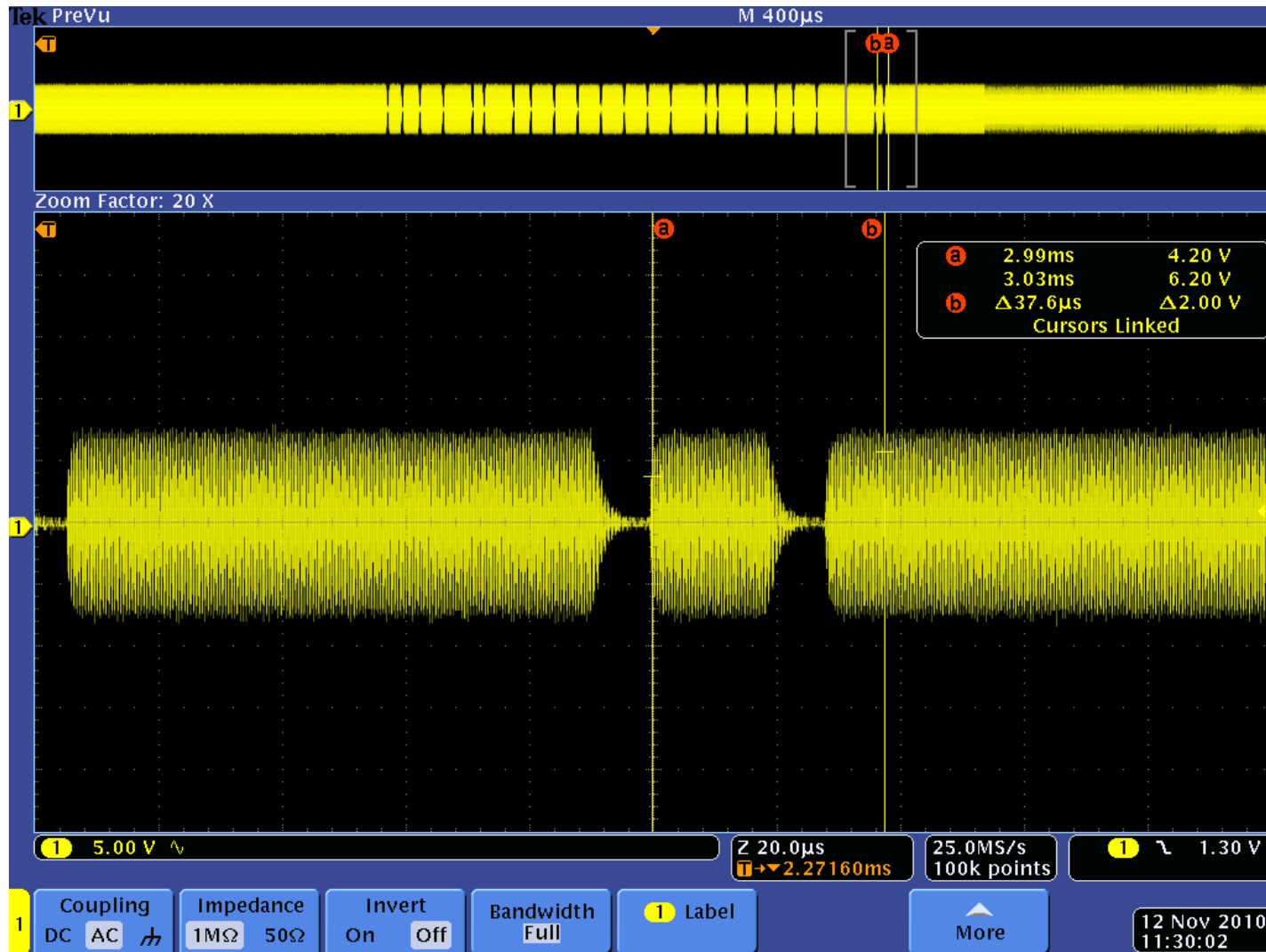

ISO15693-2

- **Air Interface Protocol –**

- PICC to PCD communications uses load modulation and one or two subcarriers may be used as selected by the VCD using the first bit in the protocol header as defined in ISO/IEC 15693-3. The VICC shall support both modes.
- When one subcarrier is used, the frequency of the subcarrier load modulation will be $fc/32$ (423.75kHz).
- When two subcarriers are used, the frequency f_1 shall be $fc/32$ (423.75kHz), and the frequency f_2 shall be $fc/28$ (484.28kHz).
- If two subcarriers are present there shall be a continuous phase relationship between them.

- **Data rates –**

- A low or high data rate may be used. The selection of the data rate shall be made by the VCD using the second bit in the protocol header as defined in ISO/IEC 15693-3. The VICC shall support the data rates shown below.

Data Rate	Single Subcarrier	Dual Subcarrier
Low	6,62 kbits/s ($f_c/2048$)	6,67 kbits/s ($f_c/2032$)
High	26,48 kbits/s ($f_c/512$)	26,69 kbits/s ($f_c/508$)

ISO15693-2

- **Data Encoding –**

- Data shall be encoded using Manchester coding, according to the following schemes. All timings shown refer to the high data rate from the VICC to the VCD.

- When using one subcarrier:

- » A logic 0 starts with 8 pulses of $fc/32$ (~423.75kHz) followed by an unmodulated time of $256/fc$ (~18.88 μ Sec)
- » A logic 1 starts with an unmodulated time of $256/fc$ (~18.88 μ s) followed by 8 pulses of $fc/32$ (~423.75kHz)

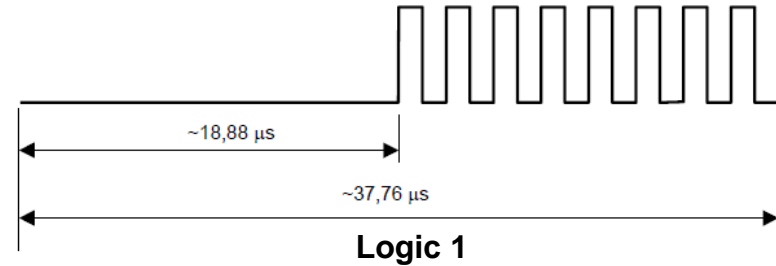
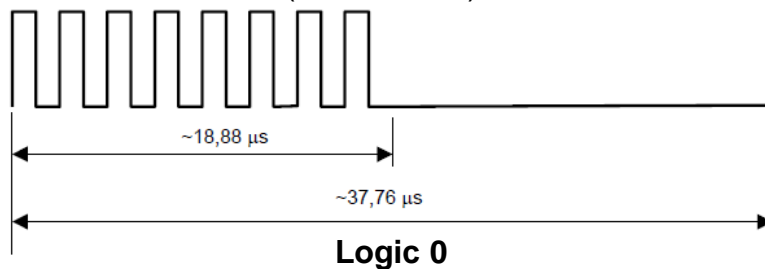

- When using two subcarriers:

- » A logic 0 starts with 8 pulses of $fc/32$ (~423.75kHz) followed by 9 pulses of $fc/28$ (~484.28kHz)
- » A logic 1 starts with 9 pulses of $fc/28$ (~484.28kHz) followed by 8 pulses of $fc/32$ (~423.75kHz)

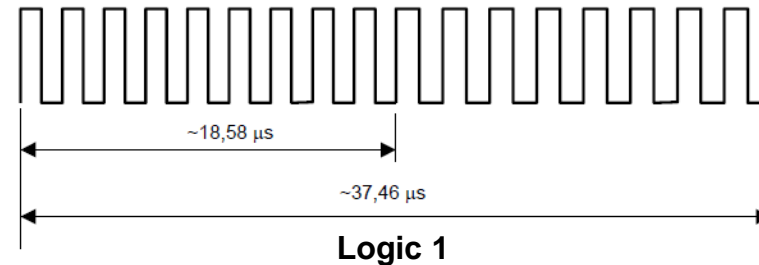
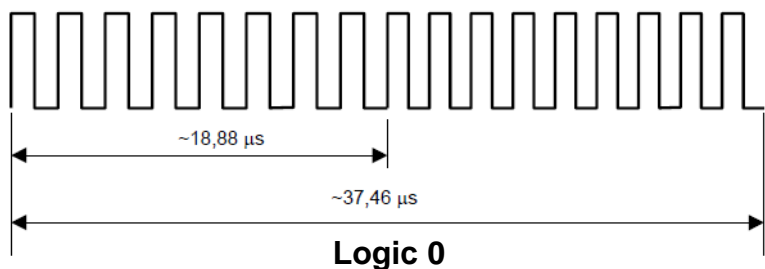

ISO15693-3

- ISO15693 General Command Request Format:**

SOF	Flags	Command code	Parameters	Data	CRC	EOF
-----	-------	--------------	------------	------	-----	-----

- The Request Flags are just as important as the command codes in ISO15693-3. The Request Flags are defined in Tables 3, 4 and 5 of the ISO15693-3 standard. Anyone who is using this standard will need to become familiar / friendly with these tables!

Table 3

Bit	Flag name	Value	Description
b1	Sub-carrier_flag	0	A single sub-carrier frequency shall be used by the VICC
		1	Two sub-carriers shall be used by the VICC
b2	Data_rate_flag	0	Low data rate shall be used
		1	High data rate shall be used
b3	Inventory_flag	0	Flags 5 to 8 meaning is according to table 4
		1	Flags 5 to 8 meaning is according to table 5
b4	Protocol Extension_flag	0	No protocol format extension
		1	Protocol format is extended. Reserved for future use

Table 4

Bit	Flag name	Value	Description
b5	Select_flag	0	Request shall be executed by any VICC according to the setting of Address_flag
		1	Request shall be executed only by VICC in selected state. The Address_flag shall be set to 0 and the UID field shall not be included in the request.
b6	Address_flag	0	Request is not addressed. UID field is not included. It shall be executed by any VICC.
		1	Request is addressed. UID field is included. It shall be executed only by the VICC whose UID matches the UID specified in the request.
b7	Option_flag	0	Meaning is defined by the command description. It shall be set to 0 if not otherwise defined by the command.
		1	Meaning is defined by the command description.
b8	RFU	0	

Table 5

Bit	Flag name	Value	Description
b5	AFI_flag	0	AFI field is not present
		1	AFI field is present
b6	Nb_slots_flag	0	16 slots
		1	1 slot
b7	Option_flag	0	Meaning is defined by the command description. It shall be set to 0 if not otherwise defined by the command.
		1	Meaning is defined by the command description.
b8	RFU	0	



ISO15693-3

- **ISO15693 Command Set:**

Command code	Type	Function
'01'	Mandatory	Inventory
'02'	Mandatory	Stay quiet
'03' – '1F'	Mandatory	RFU
'20'	Optional	Read single block
'21'	Optional	Write single block
'22'	Optional	Lock block
'23'	Optional	Read multiple blocks
'24'	Optional	Write multiple blocks
'25'	Optional	Select
'26'	Optional	Reset to ready
'27'	Optional	Write AFI
'28'	Optional	Lock AFI
'29'	Optional	Write DSFID
'2A'	Optional	Lock DSFID
'2B'	Optional	Get system information
'2C'	Optional	Get multiple block security status
'2D' – '9F'	Optional	RFU
'A0' – 'DF'	Custom	IC Mfg dependent
'E0' – 'FF'	Proprietary	IC Mfg dependent

ISO15693-3

- **Formulating ISO15693 Command Examples with Request Flags detail:**

- Implementing the Inventory Command, which uses Tables 3 & 5



FLAGS	COMMAND CODE	PARAMETER
0x26	0x01	0x00
0010 0110	Inventory	MASK LENGTH

Table 5	Table 3
B5 = 0 (no AFI)	B1 = 0 (single subcarrier)
B6 = 1 (1 slot)	B2 = 1 (high tag DR)
B7 = 0 (no option)	B3 = 1 (Table 5)
B8 = 0 (RFU)	B4 = 0 (no protocol ext.)

- Implementing the Read Single Block Command, which uses Tables 3 & 4



FLAGS	COMMAND CODE	PARAMETER
0x02	0x20	0x00 : 0x3F
00000010	Read Single Block	Block #

Table 4	Table 3
B5 = 0 (not selected)	B1 = 0 (single subcarrier)
B6 = 0 (unaddressed)	B2 = 1 (high tag DR)
B7 = 0 (no option)	B3 = 0 (Table 4)
B8 = 0 (RFU)	B4 = 0 (no protocol ext.)

ISO15693-3 Anti-Collision

- **Explanation of an anti-collision sequence:**
- The following text and figure summarizes the main cases that can occur during a typical anti-collision sequence where the number of slots is 16. The different steps are:
 - a) The VCD sends an inventory request, in a frame, terminated by an EOF. The number of slots is 16.
 - b) VICC 1 transmits its response in slot 0. It is the only one to do so, therefore no collision occurs and its UID is received and registered by the VCD
 - c) The VCD sends an EOF, meaning to switch to the next slot.
 - d) In slot 1, two VICCs 2 and 3 transmits their response, this generates a collision. The VCD detects it and remembers that a collision was detected in slot 1.
 - e) The VCD sends an EOF, meaning to switch to the next slot.
 - f) In slot 2, no VICC transmits a response. Therefore the VCD does not detect a VICC SOF and decides to switch to the next slot by sending a EOF.
 - g) In slot 3, there is another collision caused by responses from VICC 4 and 5
 - h) The VCD then decides to send an addressed request (for instance a Read Block) to VICC 1, which UID was already correctly received.
 - i) All VICCs detect a SOF and exit the anti-collision sequence. They process this request and since the request is addressed to VICC 1, only VICC1 transmit its response.
 - j) All VICCs are ready to receive another request. If it is an inventory command, the slot numbering sequence restarts from 0.

NOTE: The decision to interrupt the anti-collision sequence is up to the VCD. It could have continued to send EOF's till slot 15 and then send the request to VICC 1.

ISO15693-3 Anti-Collision

- ISO15693 Anti-collision Flow:

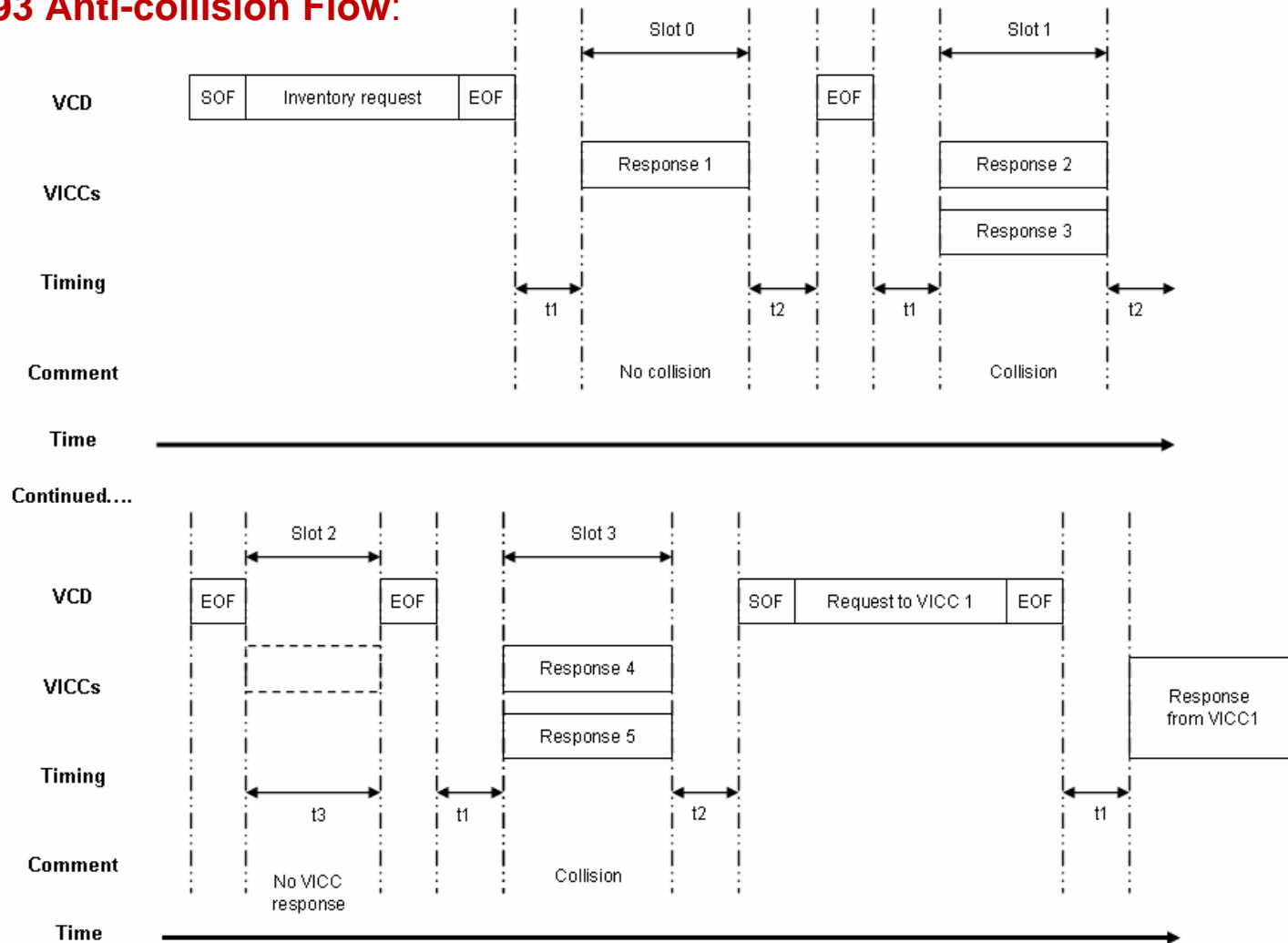

NEAR FIELD COMMUNICATIONS (NFC) DOCUMENTS OVERVIEW

NFC Specifications

- NFC Specifications are built upon the previously discussed ISO Reader/Writer/Card standards and added two modes on the transceiver side.
 - Card Emulation
 - Peer to Peer
- The ISO standards relevant to NFC are:
 - ISO14443 → Reader/Writer, Card Emulation Air Interface and Protocols
 - ISO18092 / ECMA 340 (NFCIP-1) → Field Detection, Peer To Peer
 - ISO21481 / ECMA 352 (NFCIP-2) → Mode Switching
 - ISO15693 (was referenced/added in ISO21481), upcoming Type 5 specifications
- The Japanese Standard which is relevant for NFC is:
 - JIS: X6319-4 (related to / similar to ISO18092)
 - Would have been ISO14443C, but was rejected
 - Used for NFC-F
 - Cards operate at 212kbps
 - Peers operate at 212kbps and 424kbps

ECMA / ISO Document Relationships

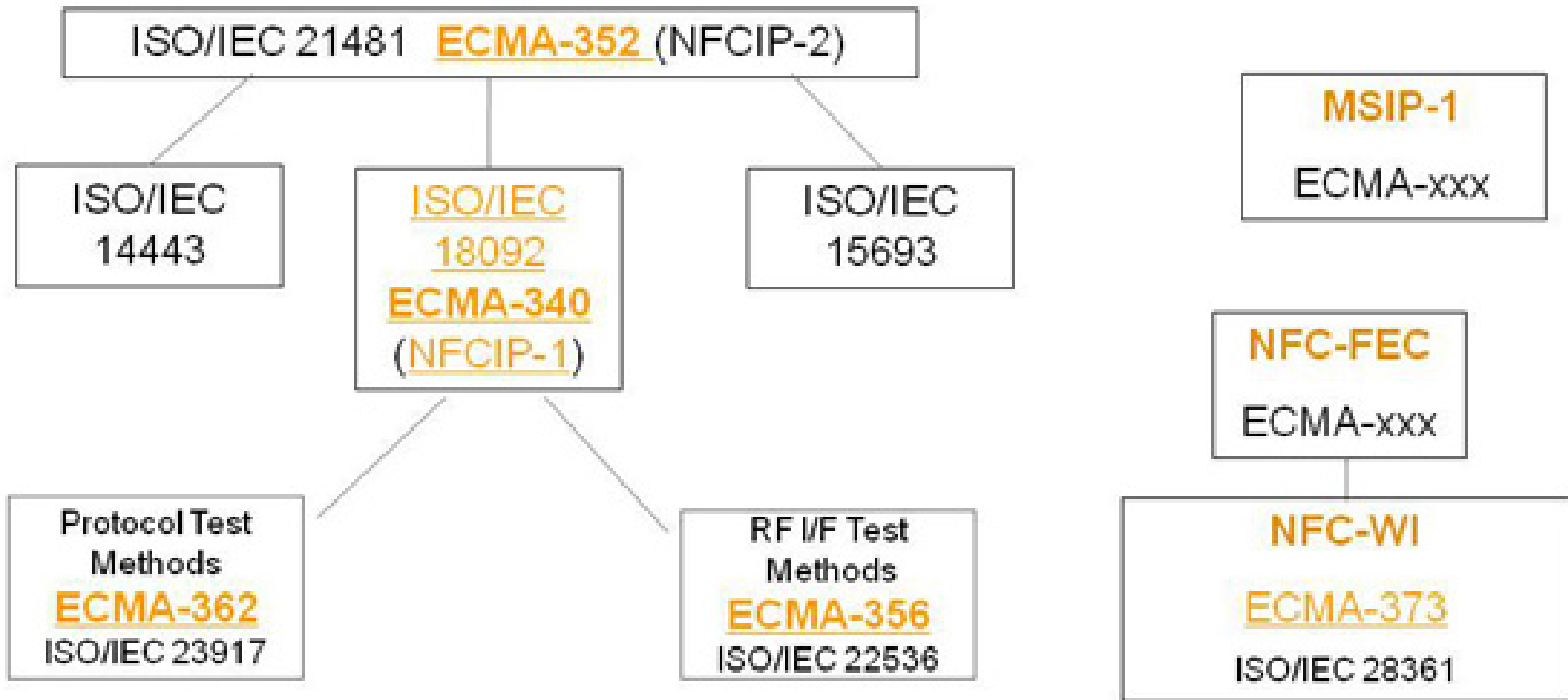

NFC protocol arrangement

NFC Forum Specification Documents

- Protocol Technical Specifications
 - **LLCP** - Defines an OSI layer-2 protocol to support peer-to-peer communication between two NFC-enabled devices, which is essential for any NFC applications that involve bi-directional communications.
 - **Digital Protocol** - This specification addresses the digital protocol for NFC-enabled device communication, providing an implementation specification on top of the ISO/IEC 18092 and ISO/IEC 14443 standards.
 - **Activity** - The specification explains how the NFC Digital Protocol Specification can be used to set up the communication protocol with another NFC device or NFC Forum tag.
 - **SNEP** - The Simple NDEF Exchange Protocol (SNEP) allows an application on an NFC-enabled device to exchange NFC Data Exchange Format (NDEF) messages with another NFC Forum device when operating in NFC Forum peer-to-peer mode.
 - **Analog** - This specification addresses the analog characteristics of the RF interface of the NFC-Enabled Device.
 - **NCI** - The NCI specification defines a standard interface within an NFC device between an NFC controller and the device's main application processor.
- Data Exchange Specification
 - **NDEF** - Specifies a common data format for NFC Forum-compliant devices and NFC Forum-compliant tags.

NFC Forum Specification Documents

- NFC Forum Tag Types Technical
 - **Type 1** - is partially based on ISO/IEC 14443A and ISO/IEC14443B. Tags are read and re-write capable; users can configure the tag to become read-only. Memory availability is 96 bytes and expandable to 2kbyte.
 - **Type 2** - is based on ISO/IEC 14443A. Tags are read and re-write capable; users can configure the tag to become read-only. Memory availability is 48 bytes and expandable to 2kbyte.
 - **Type 3** - is based on the Japanese Industrial Standard (JIS) X 6319-4, also known as FeliCa. Tags are pre-configured at manufacture to be either read and re-writable, or read-only. Memory availability is variable, theoretical memory limit is 1MByte per service.
 - **Type 4** - is fully compatible with the ISO/IEC 14443 standard series. Tags are pre-configured at manufacture to be either read and re-writable, or read-only. The memory availability is variable, up to 32 KBytes per service; the communication interface is either Type A or Type B compliant.
 - **Type 5** (in progress)
- Reference Specifications
 - **Connection Handover** - Defines the structure and sequence of interactions that enable two NFC-enabled devices to establish a connection using other wireless communication technologies. Connection Handover combines the simple, one-touch set-up of NFC with high-speed communication technologies, such as WiFi or Bluetooth. The specification enables developers to choose the carrier for the information to be exchanged. If matching wireless capabilities are revealed during the negotiation process between two NFC-enabled devices, the connection can switch to the selected carrier. With this specification, other communication standards bodies can define information required for the connection setup to be carried in NFC Data Exchange Format (NDEF) messages.

NFC Forum Specification Documents

- Record Type Definitions
 - **RTD Technical** - Specifies the format and rules for building standard record types used by NFC Forum application definitions and third parties that are based on the NDEF data format.
 - **Text** - Provides an efficient way to store text strings in multiple languages by using the RTD mechanism and NDEF format. An example of using this specification is included in the Smart Poster RTD.
 - **URI** - Provides an efficient way to store Uniform Resource Identifiers (URI) by using the RTD mechanism and NDEF format. An example of using this specification is included in the Smart Poster RTD.
 - **Smart Poster** - Defines an NFC Forum Well Known Type to put URLs, SMSs or phone numbers on an NFC tag, or to transport them between devices. The Smart Poster RTD builds on the RTD mechanism and NDEF format and uses the URI RTD and Text RTD as building blocks.
 - **Generic Control** - withdrawn
 - **Signature** - Specifies the format used when signing single or multiple NDEF records. Defines the required and optional signature RTD fields, and also provides a list of suitable signature algorithms and certificate types that can be used to create the signature. Does not define or mandate a specific PKI or certification system, or define a new algorithm for use with the Signature RTD.
 - **PHDC** - Addresses a need for an openly-defined standard for the exchange of personal health data between devices using Near Field Communication technology.

Combining what we have learned to support NFC Types 2-5 Tag Platforms as a Reader/Writer

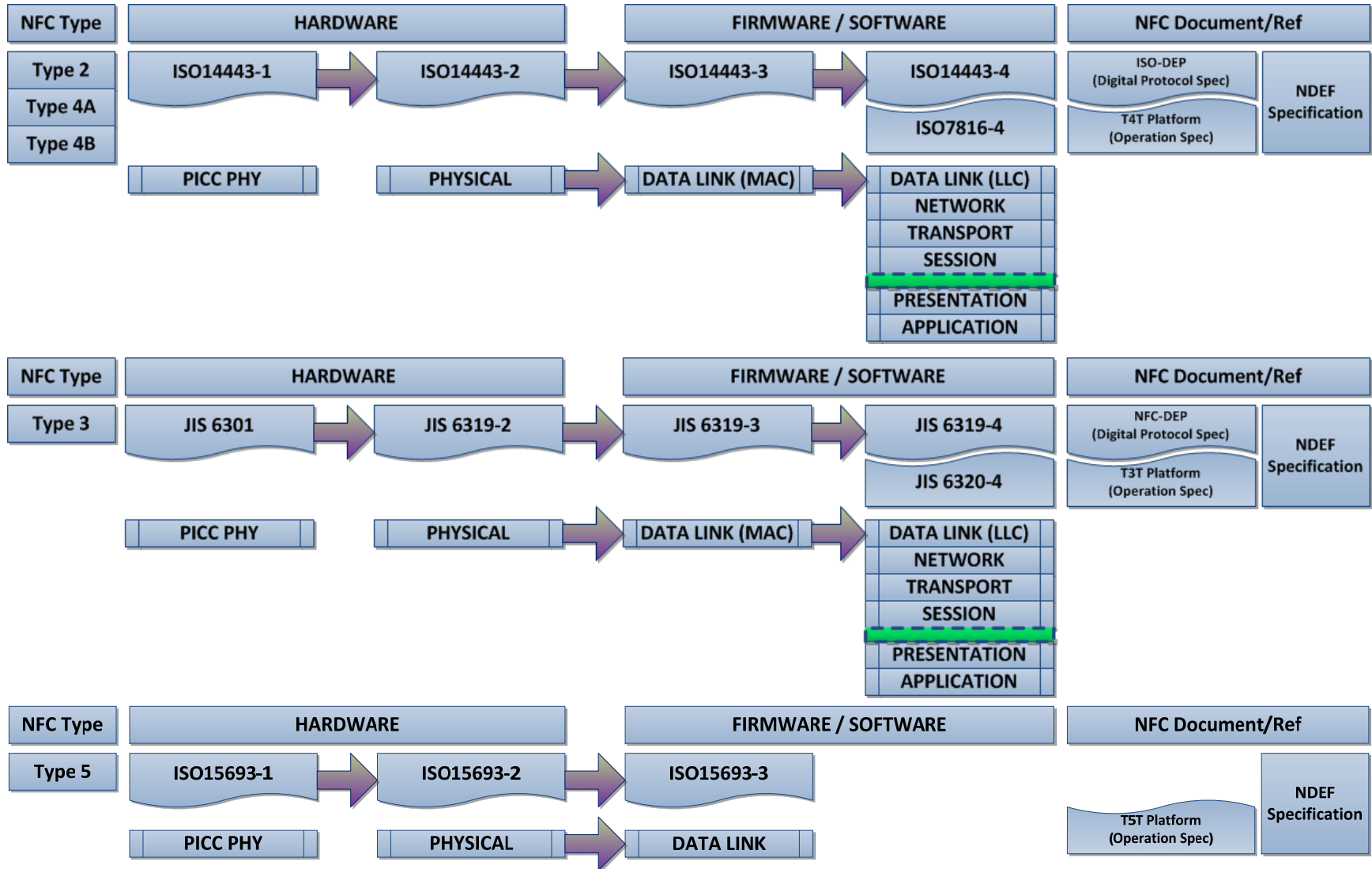

Supporting NFC Types 4A & 4B Tag Platforms Emulation

- Essentially same as previous slide, except PICC sides are supported.

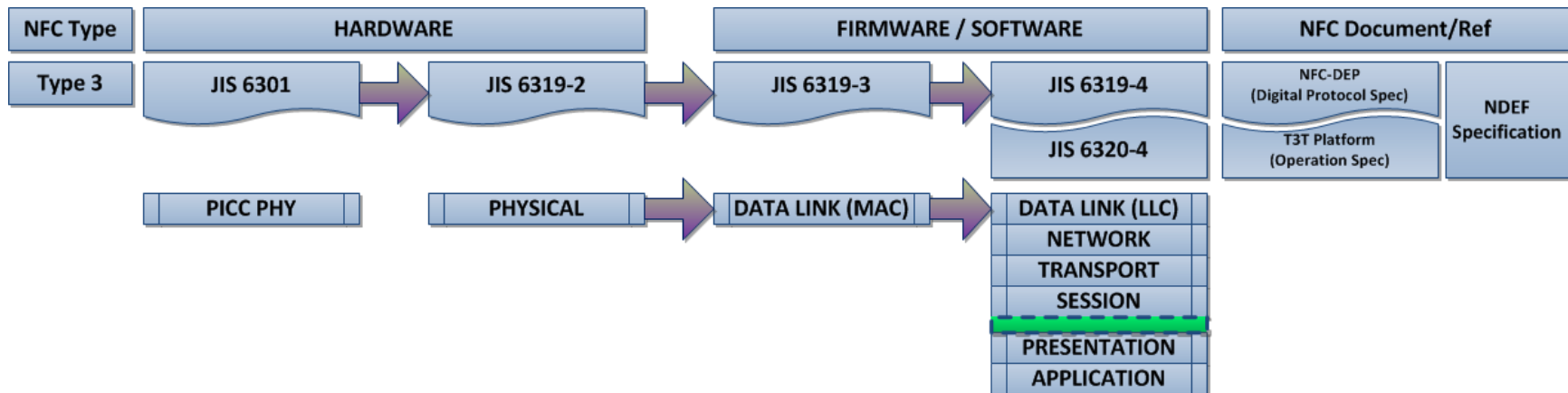
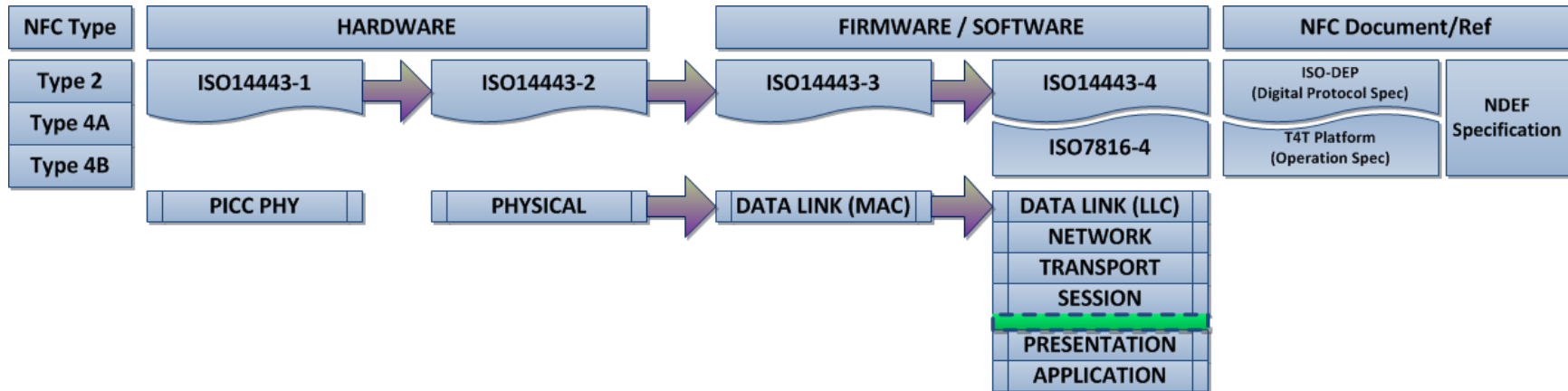

Supporting NFC Peer to Peer Platforms

- Peer to Peer uses NFC-A or NFC-F
 - Device can be:
 - Active Initiator / Target
 - Passive Initiator / Target

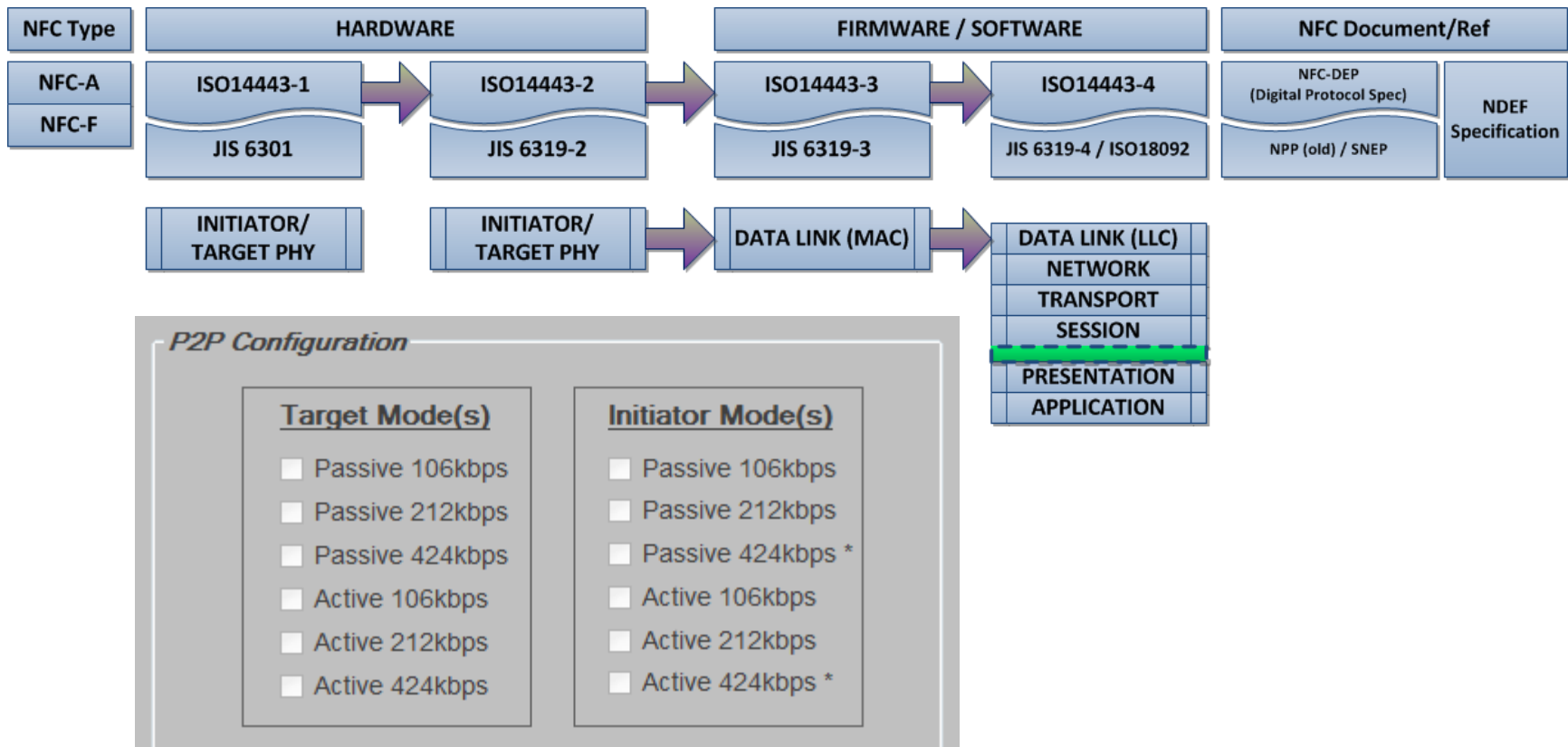

NEAR FIELD COMMUNICATIONS (NFC) SW STATE MACHINES

Software State Machine (Listen Mode)

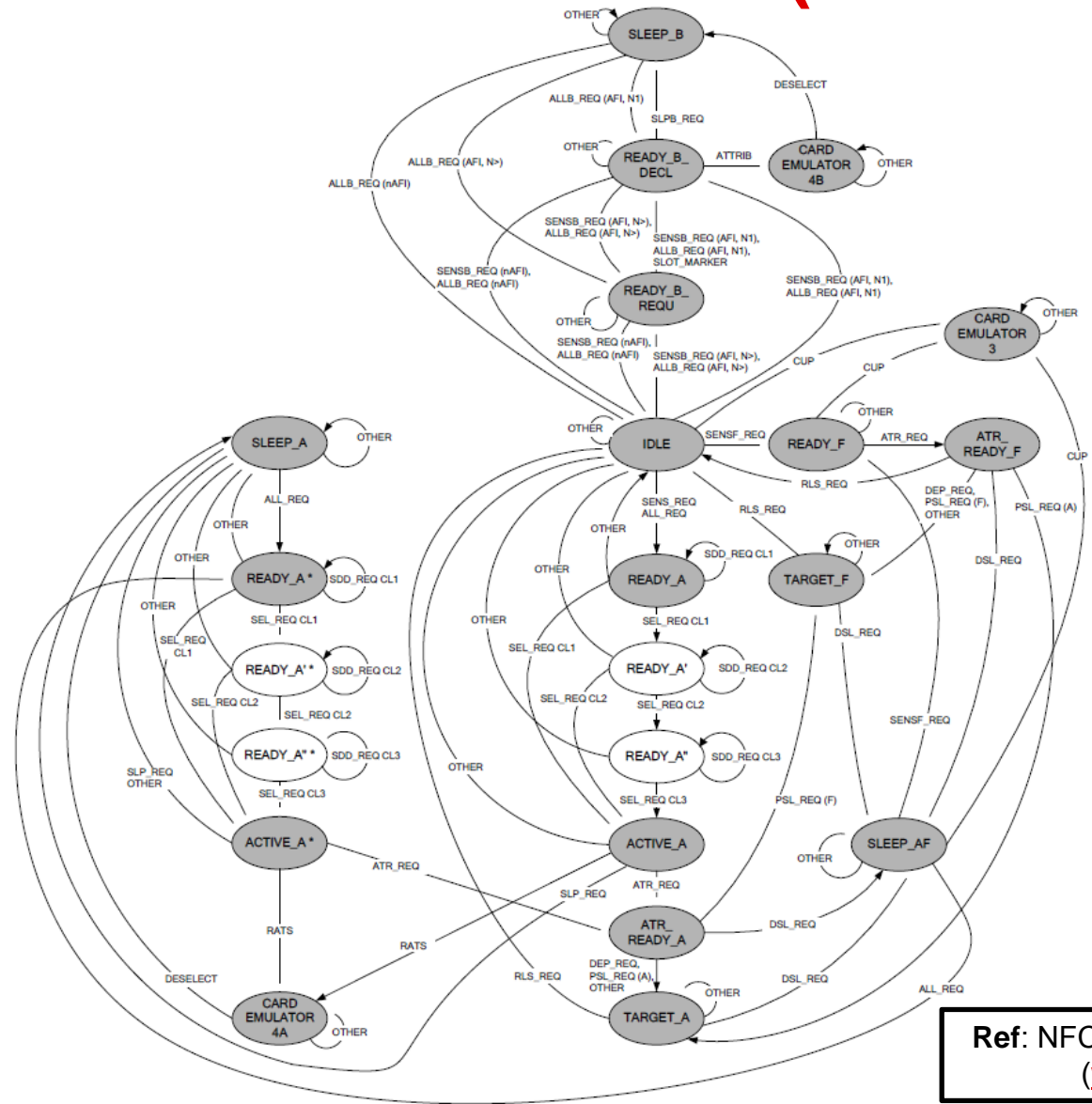

Ref: NFC Activity Technical Spec 1.0
www.nfc-forum.org

Software State Machine (Poll Mode Activities)

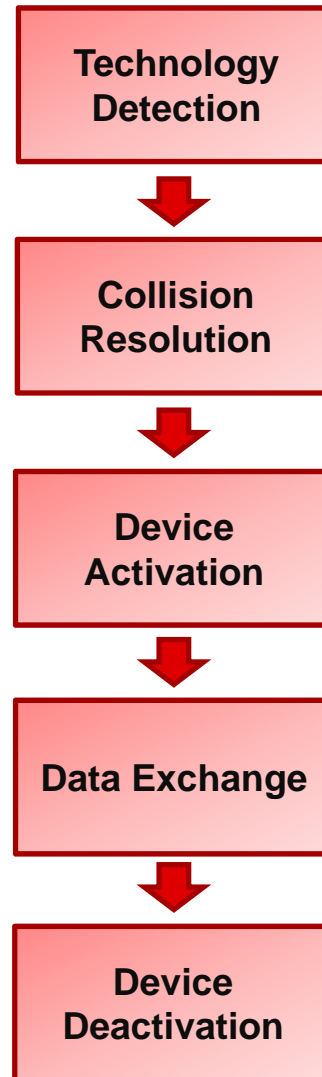

Technology Detection Activity

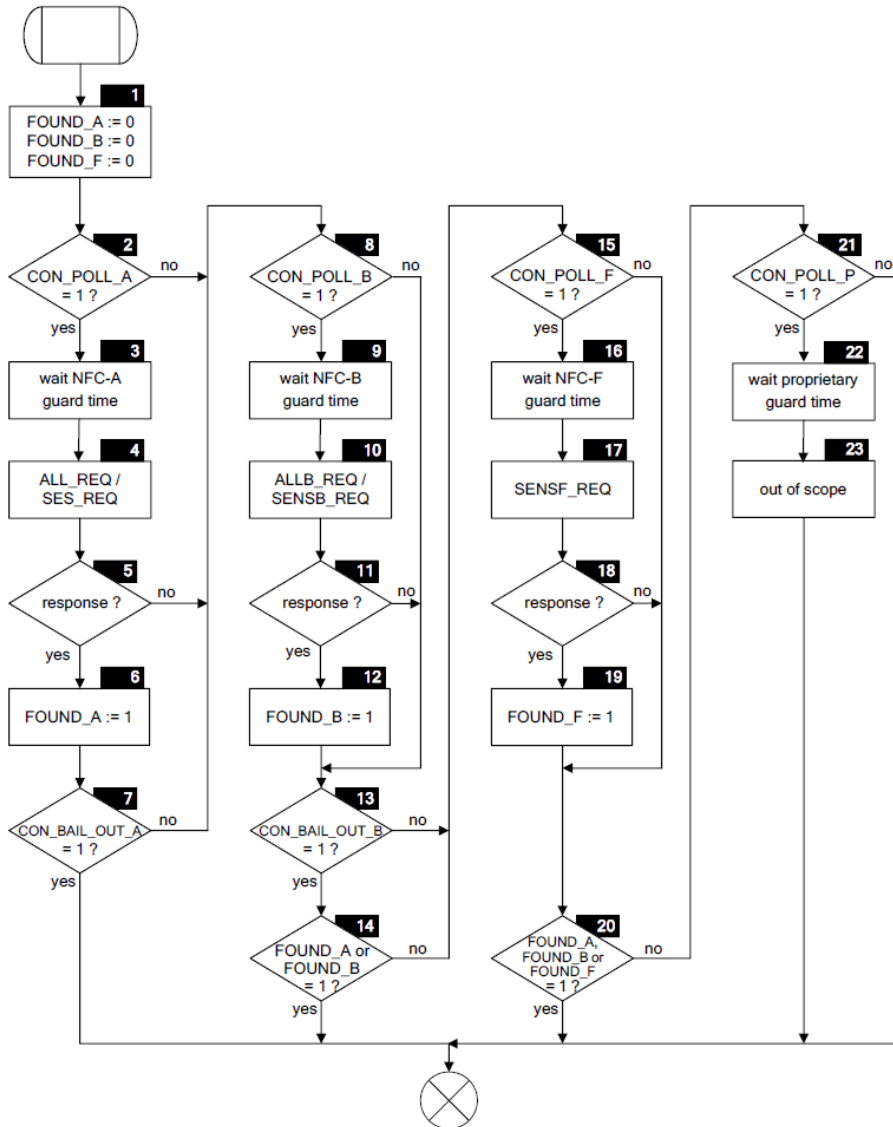

Purpose: Scan for devices of certain technologies that are within range.

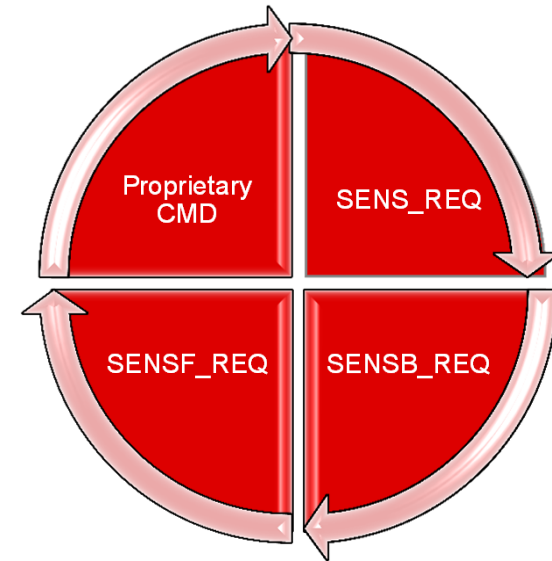

Ref: NFC Activity Technical Spec 1.0
(www.nfc-forum.org)

Collision Resolution Activity

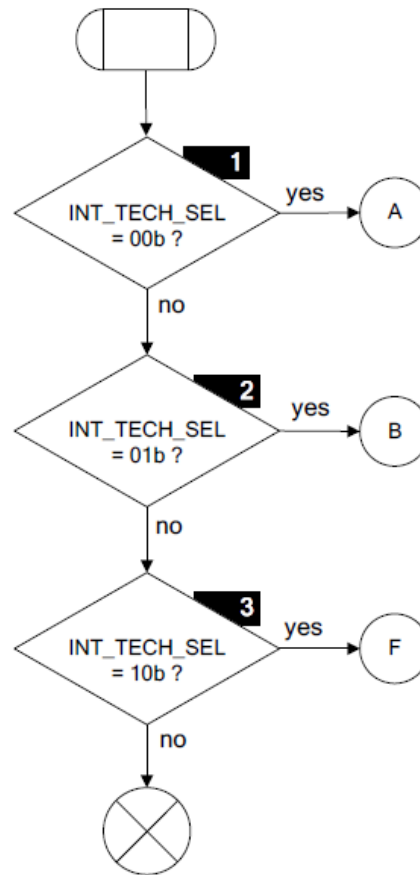

Purpose: Identify an NFC Forum Device within range that has been activated in the Technology Detection Activity.

INT_TECH_SEL	binary	2 bit	00b: Resolve NFC-A Technology 01b: Resolve NFC-B Technology 10b: Resolve NFC-F Technology
--------------	--------	-------	---

Ref: NFC Activity Technical Spec 1.0
(www.nfc-forum.org)

Device Activation Activity

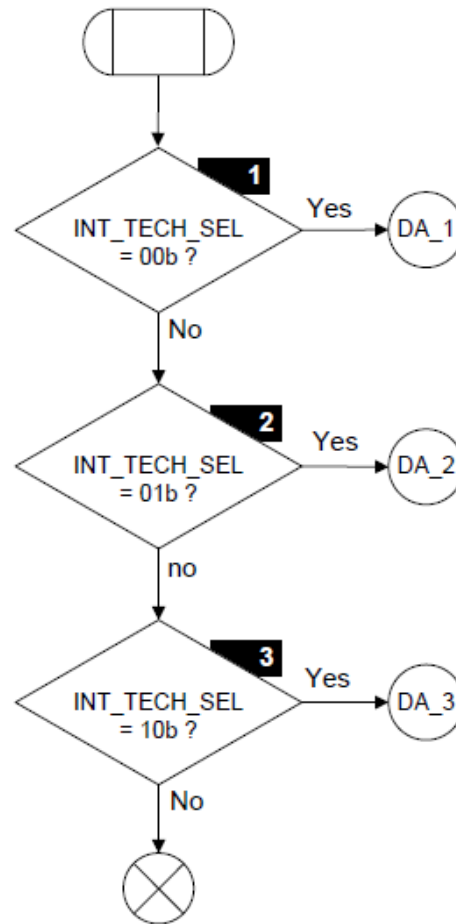

Purpose: Activate one device out of the set of devices identified during the Technology Detection and Collision Resolution Activities.

INT_TECH_SEL	binary	2 bit	00b: Resolve NFC-A Technology 01b: Resolve NFC-B Technology 10b: Resolve NFC-F Technology
--------------	--------	-------	---

Ref: NFC Activity Technical Spec 1.0
(www.nfc-forum.org)

Device Exchange Activity

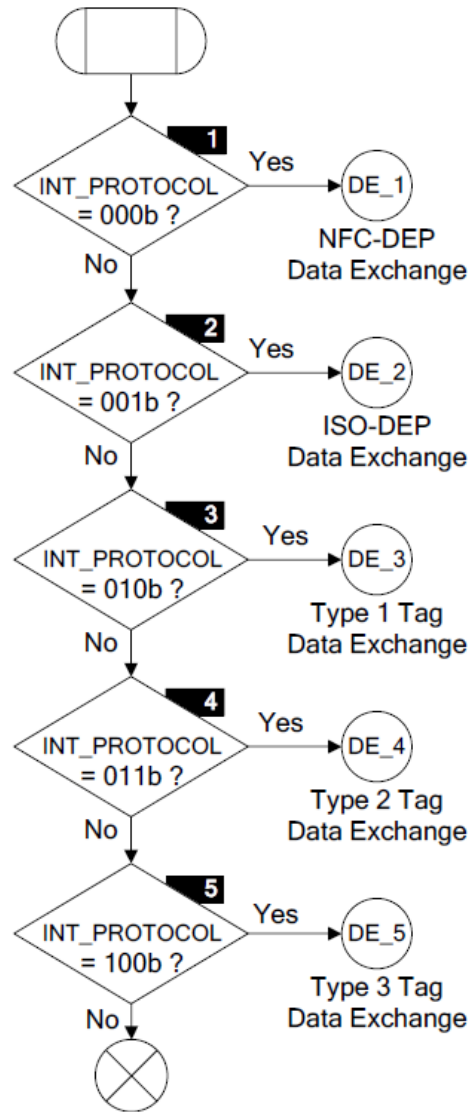

Purpose: Exchange data with an NFC Forum Device within range.

INT_PROTOCOL	binary	3 bit	Protocol to be deactivated:
			- 000b: Using NFC-DEP
			- 001b: Using ISO-DEP
			- 010b: Using Type 1 Tag Platform protocol
			- 011b: Using Type 2 Tag Platform protocol
			- 100b: Using Type 3 Tag Platform protocol

Ref: NFC Activity Technical Spec 1.0
www.nfc-forum.org

Device Deactivation Activity

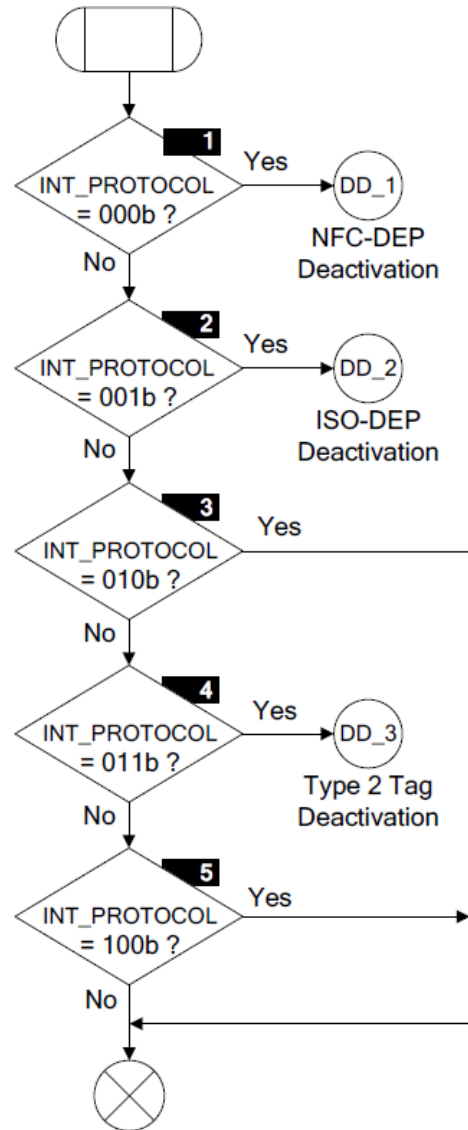

Purpose: Deactivate an NFC Forum Device within range.

INT_PROTOCOL	binary	3 bit	Protocol to be deactivated:
			- 000b: Using NFC-DEP
			- 001b: Using ISO-DEP
			- 010b: Using Type 1 Tag Platform protocol
			- 011b: Using Type 2 Tag Platform protocol
			- 100b: Using Type 3 Tag Platform protocol

Ref: NFC Activity Technical Spec 1.0
www.nfc-forum.org

NFC Standalone SW Structure Overview

