



CE Radio Test Report

APPLICANT : Texas Instruments Incorporated
EQUIPMENT : WiFi and Bluetooth Module
BRAND NAME : Texas Instruments
MODEL NAME : WL18MODGI
MARKETING NAME : WL18x7MOD WiLink™ 8 Dual-Band Industrial Module –Wi-Fi®, Bluetooth®, and Bluetooth Low Energy (LE)
STANDARD : ETSI EN 300 328 V2.1.1 (2016-11)
TEST DATE(S) : Jun. 06, 2017

The measurement shown in this variant report is tested in accordance with the test procedures given in ETSI EN 300 328 V2.1.1 (2016-11).

The test results in this report apply exclusively to the tested model / sample. Without written approval of SPORTON INTERNATIONAL INC., the test report shall not be reproduced except in full.

Reviewed by: Joseph Lin / Supervisor

Approved by: Jones Tsai / Manager



SPORTON INTERNATIONAL INC.

No. 52, Hwa Ya 1st Rd., Hwa Ya Technology Park, Kwei-Shan District, Tao Yuan City, Taiwan R.O.C.

SPORTON INTERNATIONAL INC.

TEL : 886-3-327-3456

FAX : 886-3-328-4978

Page Number : 1 of 14

Report Issued Date : Jun. 15, 2017

Report Version : Rev. 01

Report Template No.: BU5-ER328 2024 Version 2.1



TABLE OF CONTENTS

REVISION HISTORY.....3

SUMMARY OF TEST RESULT4

1 GENERAL DESCRIPTION5

 1.1 Applicant5

 1.2 Manufacturer.....5

 1.3 Product Feature of Equipment Under Test.....5

 1.4 Modification of EUT5

 1.5 Testing Facility.....6

 1.6 Applied Standards6

2 RECEIVER PARAMETERS.....7

 2.1 Receiver Blocking Test.....7

3 LIST OF MEASURING EQUIPMENT13

4 UNCERTAINTY EVALUATION14

APPENDIX A. ORIGINAL REPORT



REVISION HISTORY

REPORT NO.	VERSION	DESCRIPTION	ISSUED DATE
ER741330A	Rev. 01	Initial issue of report	Jun. 15, 2017



SUMMARY OF TEST RESULT

CLAUSE (EN 300 328)	TEST PARAMETER	PASS/FAIL	REMARK
Transmitter Parameters			
4.3.1.2 4.3.2.2	Maximum Transmit Power	Not Required	-
4.3.2.3	Maximum Equivalent Isotropically Radiated Power (E.I.R.P.) Spectral Density	Not Required	Only applicable for modulations other than FHSS
4.3.1.8 4.3.2.7	Occupied Channel Bandwidth	Not Required	-
4.3.1.4 4.3.1.5	Frequency Hopping Requirements	Not Required	Only applicable for FHSS
4.3.1.9 4.3.2.8	Transmitter spurious emissions in OOB	Not Required	-
4.3.1.10 4.3.2.9	Transmitter spurious emissions	Not Required	-
Receiver Parameters			
4.3.1.11 4.3.2.10	Receiver spurious emissions	Not Required	-
Adaptive Test Item			
4.3.1.7 4.3.2.6	Adaptivity	Not Required	Only applicable for adaptive equipment Output Power >10dBm
4.3.1.12 4.3.2.11	Receiver Blocking	PASS	
Non-Adaptive Test Item			
4.3.1.3 4.3.2.4	Duty cycle, Tx-Sequence, Tx-gap	Not Required	Only applicable for non-adaptive equipment Output Power >10dBm
4.3.1.6 4.3.2.5	Medium Utilisation (MU) factor	Not Required	



1 General Description

1.1 Applicant

Texas Instruments Incorporated
12500 TI BLVD., Dallas Texas, 75243

1.2 Manufacturer

Texas Instruments Incorporated
12500 TI BLVD., Dallas Texas, 75243

1.3 Product Feature of Equipment Under Test

Bluetooth, WLAN 802.11 b/g/n, 802.11 a/n

Antenna information				
	Brand	Antenna Type	Model	2.4GHz ~2.5GHz Gain
1	Ethertronics	PCB	100423	-0.6dBi
2	LSR	Rubber Whip / Dipole	001-0012	2dBi
3			080-0013	2dBi
4			080-0014	2dBi
5		PIFA	001-0016	2.5dBi
6	001-0021		2.5dBi	
7	Laird	PCB	CAF94504	2dBi
8			CAF94505	2dBi
9	Pulse	CHIP	W3006	3.2dBi
10	TDK	CHIP	ANT016008	2.5dBi

Remark:

1. This is a variant report by updating test standards to RED. All the test cases were performed on original report which can be referred to Sporton Report Number ER4O0971A and ER4O0971B as appendix A.
2. The EUT used a 2.4GHz CHIP antenna (Brand: Pulse).

1.4 Modification of EUT

No modifications are made to the EUT during all test items.



1.5 Testing Facility

Test Site	SPORTON INTERNATIONAL INC.
Test Site Location	No. 52, Hwa Ya 1st Rd.,Hwa Ya Technology Park, Kwei-Shan District, Tao Yuan City, Taiwan R.O.C. TEL: +886-3-327-3456 FAX: +886-3-328-4978
Test Site No.	Sporton Site No. : DFS02-HY

1.6 Applied Standards

According to the specifications of the manufacturer, the EUT must comply with the requirements of **ETSI EN 300 328 V2.1.1 (2016-11)**.

Note: All test items were verified and recorded according to the standards and without any deviation during the test.

2 Receiver Parameters

2.1 Receiver Blocking Test

2.1.1 Limit of Receiver Blocking Test

Receiver category 1

- Adaptive equipment with maximum RF output power > 10dBm e.i.r.p. (EX: WiFi)

Wanted signal mean power from companion device (dBm)	Blocking signal frequency (MHz)	Blocking signal power (dBm) (see note 2)	Type of blocking signal
$P_{min} + 6$ dB	2 380 2 503,5	-53	CW
$P_{min} + 6$ dB	2 300 2 330 2 360	-47	CW
$P_{min} + 6$ dB	2 523,5 2 553,5 2 583,5 2 613,5 2 643,5 2 673,5	-47	CW
NOTE 1: P_{min} is the minimum level of wanted signal (in dBm) required to meet the minimum performance criteria as defined in clause 4.3.1.12.3 in the absence of any blocking signal.			
NOTE 2: The levels specified are levels in front of the UUT antenna. In case of conducted measurements, the levels have to be corrected by the actual antenna assembly gain.			

Receiver category 2

- Non-adaptive equipment with MU 1% ~ 10%
- Adaptive equipment with Maximum RF output power < 10dBm e.i.r.p. (EX: Bluetooth)

Wanted signal mean power from companion device (dBm)	Blocking signal frequency (MHz)	Blocking signal power (dBm) (see note 2)	Type of blocking signal
$P_{min} + 6$ dB	2 380 2 503,5	-57	CW
$P_{min} + 6$ dB	2 300 2 583,5	-47	CW
NOTE 1: P_{min} is the minimum level of the wanted signal (in dBm) required to meet the minimum performance criteria as defined in clause 4.3.1.12.3 in the absence of any blocking signal.			
NOTE 2: The levels specified are levels in front of the UUT antenna. In case of conducted measurements, the levels have to be corrected by the actual antenna assembly gain.			

Receiver category 3

1. Non-adaptive equipment with $MU < 1\%$
2. Adaptive equipment with Maximum RF output power $< 0\text{dBm e.i.r.p.}$

Wanted signal mean power from companion device (dBm)	Blocking signal frequency (MHz)	Blocking signal power (dBm) (see note 2)	Type of blocking signal
$P_{min} + 12\text{ dB}$	2 380 2 503,5	-57	CW
$P_{min} + 12\text{ dB}$	2 300 2 583,5	-47	CW

NOTE 1: P_{min} is the minimum level of the wanted signal (in dBm) required to meet the minimum performance criteria as defined in clause 4.3.1.12.3 in the absence of any blocking signal.

NOTE 2: The levels specified are levels in front of the UUT antenna. In case of conducted measurements, the levels have to be corrected by the actual antenna assembly gain.

2.1.2 Measuring Instruments

The measuring equipment is listed in the section 8 of this test report.

2.1.3 Test Procedures

1. The measurement procedure follows the clause 5.4.11.2.1 of the ETSI EN 300 328 V2.1.1 (2016-11).
2. For systems using multiple receive chains only one chain (antenna port) need to be tested. All other receiver inputs shall be terminated.

2.1.4 Test Setup

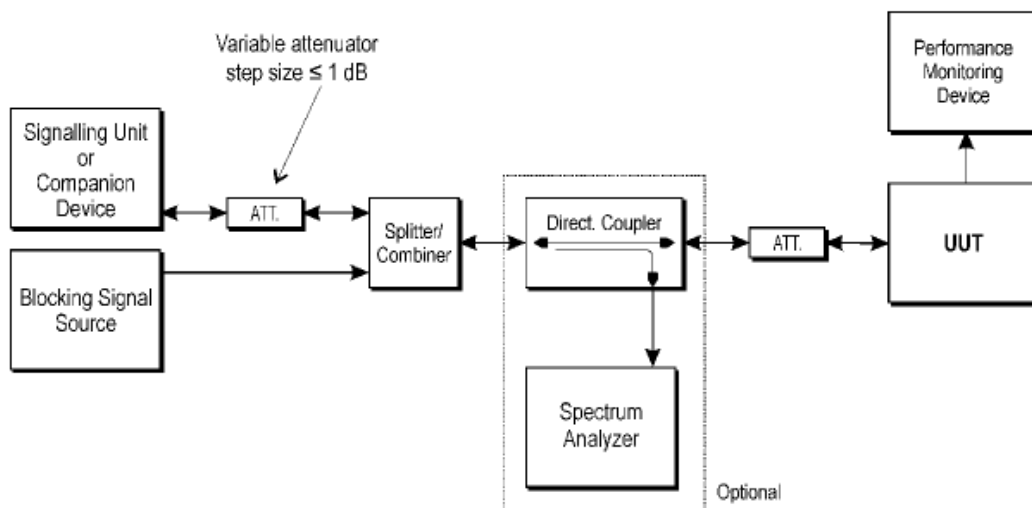

Test Set-up for receiver blocking



2.1.5 Test Results of Receiver Blocking

Pmin = CMW500 burst power - path cable loss - attenuator.

Bluetooth 1Mbps hopping mode			
Wanted signal From companion	Blocking signal Frequency(MHz)	Blocking signal Power(dBm)	PER (%)
Pmin + 6dB	2380	-53	0.1
Pmin + 6dB	2503.5	-53	0.2
Pmin + 6dB	2300	-47	0.3
Pmin + 6dB	2330	-47	0.3
Pmin + 6dB	2360	-47	0
Pmin + 6dB	2523.5	-47	0.1
Pmin + 6dB	2553.5	-47	0.1
Pmin + 6dB	2583.5	-47	0.1
Pmin + 6dB	2613.5	-47	0.1
Pmin + 6dB	2643.5	-47	0
Pmin + 6dB	2573.5	-47	0.1
PER = 4.49 % when Pmin= -92 dBm before blocker is injected.			

Note:

- 1. Antenna gain is 3.2 dBi.
- 2. Blocking signal power level has offset antenna gain 3.2 dBi.



Bluetooth BLE Channel 00			
Wanted signal From companion	Blocking signal Frequency(MHz)	Blocking signal Power(dBm)	PER (%)
Pmin + 6 dB	2380	-57	0
Pmin + 6 dB	2503.5	-57	0
Pmin + 6 dB	2300	-47	0
Pmin + 6 dB	2583.5	-47	0
PER = 3 % when Pmin= -92 dBm before blocker is injected.			

Note:

1. Antenna gain is 3.2 dBi.
2. Blocking signal power level has offset antenna gain 3.2 dBi.

Bluetooth BLE Channel 39			
Wanted signal From companion	Blocking signal Frequency(MHz)	Blocking signal Power(dBm)	PER (%)
Pmin + 6 dB	2380	-57	0
Pmin + 6 dB	2503.5	-57	0
Pmin + 6 dB	2300	-47	0
Pmin + 6 dB	2583.5	-47	0
PER = 2.5 % when Pmin= -91 dBm before blocker is injected.			

Note:

1. Antenna gain is 3.2 dBi.
2. Blocking signal power level has offset antenna gain 3.2 dBi.



WiFi 802.11b 1Mbps Channel 01			
Wanted signal From companion	Blocking signal Frequency(MHz)	Blocking signal Power(dBm)	PER (%)
Pmin + 6dB	2380	-53	0.1
Pmin + 6dB	2503.5	-53	0.1
Pmin + 6dB	2300	-47	0
Pmin + 6dB	2330	-47	0
Pmin + 6dB	2360	-47	0.1
Pmin + 6dB	2523.5	-47	0.3
Pmin + 6dB	2553.5	-47	0
Pmin + 6dB	2583.5	-47	0
Pmin + 6dB	2613.5	-47	0
Pmin + 6dB	2643.5	-47	0.2
Pmin + 6dB	2673.5	-47	0.4
PER = 8 % when Pmin= -94 dBm before blocker is injected.			

Note:

1. Antenna gain is 3.2 dBi.
2. Blocking signal power level has offset antenna gain 3.2 dBi.

WiFi 802.11b 1Mbps Channel 13			
Wanted signal From companion	Blocking signal Frequency(MHz)	Blocking signal Power(dBm)	PER (%)
Pmin + 6dB	2380	-53	0.2
Pmin + 6dB	2503.5	-53	0.1
Pmin + 6dB	2300	-47	0.1
Pmin + 6dB	2330	-47	0.2
Pmin + 6dB	2360	-47	0.1
Pmin + 6dB	2523.5	-47	0.1
Pmin + 6dB	2553.5	-47	0.1
Pmin + 6dB	2583.5	-47	0.1
Pmin + 6dB	2613.5	-47	0.2
Pmin + 6dB	2643.5	-47	0.1
Pmin + 6dB	2673.5	-47	0.2
PER = 3.3 % when Pmin= -93 dBm before blocker is injected.			

Note:

1. Antenna gain is 3.2 dBi.
2. Blocking signal power level has offset antenna gain 3.2 dBi.



WiFi 802.11g 6Mbps Channel 01			
Wanted signal From companion	Blocking signal Frequency(MHz)	Blocking signal Power(dBm)	PER (%)
Pmin + 6dB	2380	-53	1.2
Pmin + 6dB	2503.5	-53	0.7
Pmin + 6dB	2300	-47	0.3
Pmin + 6dB	2330	-47	1
Pmin + 6dB	2360	-47	1.1
Pmin + 6dB	2523.5	-47	0.5
Pmin + 6dB	2553.5	-47	0.4
Pmin + 6dB	2583.5	-47	1
Pmin + 6dB	2613.5	-47	1.4
Pmin + 6dB	2643.5	-47	1.3
Pmin + 6dB	2673.5	-47	0.4
PER = 4.9 % when Pmin= -86 dBm before blocker is injected.			

Note:

1. Antenna gain is 3.2 dBi.
2. Blocking signal power level has offset antenna gain 3.2 dBi.

WiFi 802.11g 6Mbps Channel 13			
Wanted signal From companion	Blocking signal Frequency(MHz)	Blocking signal Power(dBm)	PER (%)
Pmin + 6dB	2380	-53	0.6
Pmin + 6dB	2503.5	-53	0.2
Pmin + 6dB	2300	-47	0.7
Pmin + 6dB	2330	-47	0.7
Pmin + 6dB	2360	-47	0.5
Pmin + 6dB	2523.5	-47	0.7
Pmin + 6dB	2553.5	-47	0.4
Pmin + 6dB	2583.5	-47	1.1
Pmin + 6dB	2613.5	-47	0.9
Pmin + 6dB	2643.5	-47	0.8
Pmin + 6dB	2673.5	-47	1
PER = 5.2 % when Pmin= -86 dBm before blocker is injected.			

Note:

1. Antenna gain is 3.2 dBi.
2. Blocking signal power level has offset antenna gain 3.2 dBi.



3 List of Measuring Equipment

Instrument	Manufacturer	Model No.	Serial No.	Characteristics	Calibration Date	Test Date	Due Date	Remark
Spectrum Analyzer	Agilent	E4445A	MY41000161	3Hz~13.2GHz	Nov. 28, 2016	Jun. 06, 2017	Nov. 27, 2017	Conducted (DFS02-HY)
Base Station	Rohde & Schwarz	CMW500	132247	GSM/GPRS/WC DMA/FD-LTE/TD -LTE/MIMO	Dec. 14, 2016	Jun. 06, 2017	Dec. 13, 2017	Conducted (DFS02-HY)
Signal Generator	Rohde & Schwarz	SMF100A	101107	100kHz~40GHz	May 22, 2017	Jun. 06, 2017	May 21, 2018	Conducted (DFS02-HY)

Note: Test equipment calibration is traceable to the procedure of ISO17025.



4 Uncertainty Evaluation

Test Item	Uncertainty
Temperature	± 0.8 °C
Humidity	± 3 %



Appendix A. Original Report

Please refer to Sporton report number ER4O0971A as below.



CE Radio Test Report

APPLICANT : Texas Instruments Incorporated
EQUIPMENT : WiFi and Bluetooth Module
BRAND NAME : Texas Instruments
MODEL NAME : WL18MODGI
STANDARD : ETSI EN 300 328 V1.8.1 (2012-06)
TEST DATE(S) : Nov. 27, 2014 ~ Dec. 10, 2014

The measurement shown in this test report is tested in accordance with the test procedures given in EN 300 328 V1.8.1 (2012-06).

The test results in this report apply exclusively to the tested model / sample. Without written approval of SPORTON INTERNATIONAL INC., the test report shall not be reproduced except in full.

Reviewed by: Joseph Lin / Supervisor

Approved by: Jones Tsai / Manager



SPORTON INTERNATIONAL INC.

No. 52, Hwa Ya 1st Rd., Hwa Ya Technology Park, Kwei-Shan Hsiang, Tao Yuan Hsien, Taiwan, R.O.C.

SPORTON INTERNATIONAL INC.
TEL : 886-3-327-3456
FAX : 886-3-328-4978

Page Number : 1 of 45
Report Issued Date : Jan. 12, 2015
Report Version : Rev. 01

Report Template No.: BU5-ER328181 Version 1.0



TABLE OF CONTENTS

REVISION HISTORY	3
SUMMARY OF TEST RESULT	4
1 GENERAL DESCRIPTION	5
1.1 Applicant	5
1.2 Manufacturer.....	5
1.3 Product Feature of Equipment Under Test.....	5
1.4 Product Specification subjective to this standard	5
1.5 Modification of EUT	6
1.6 Testing Facility.....	6
1.7 Applied Standards	7
1.8 Test Condition.....	7
2 TEST CONFIGURATION OF EQUIPMENT UNDER TEST	8
2.1 Descriptions of Test Mode.....	8
2.2 Connection Diagram of EUT Test Configurations	9
2.3 Supported Unit used in test configuration and system	9
2.4 EUT Operation Test Setup	9
3 TRANSMITTER PARAMETERS	10
3.1 Maximum Transmit Power.....	10
3.2 Maximum Equivalent Isotropically Radiated Power (E.I.R.P.) Spectral Density	12
3.3 Occupied Channel Bandwidth	14
3.4 Frequency Hopping Requirements.....	16
3.5 Transmitter unwanted emissions in the out-of-band domain	23
3.6 Transmitter spurious emissions.....	25
4 RECEIVER PARAMETERS	33
4.1 Receiver spurious emissions.....	33
5 ADAPTIVITY TEST	38
5.1 Adaptivity and Receiver Blocking	38
6 PHOTOGRAPHS OF RADIATED EMISSION TEST CONFIGURATION	43
7 LIST OF MEASURING EQUIPMENT	44
8 UNCERTAINTY EVALUATION	45



SUMMARY OF TEST RESULT

CLAUSE (EN 300 328)	TEST PARAMETER	PASS/FAIL	REMARK
Transmitter Parameters			
4.3.1.1 4.3.2.1	Maximum Transmit Power	PASS	-
4.3.2.2	Maximum Equivalent Isotropically Radiated Power (E.I.R.P.) Spectral Density	PASS	Only applicable for modulations other than FHSS
4.3.1.7 4.3.2.6	Occupied Channel Bandwidth	PASS	-
4.3.1.3 4.3.1.4	Frequency Hopping Requirements	PASS	Only applicable for FHSS
4.3.1.8 4.3.2.7	Transmitter spurious emissions in OOB	PASS	Under limit 10.46 dB
4.3.1.9 4.3.2.8	Transmitter spurious emissions	PASS	Under limit 11.74 dB at 11561.250 MHz
Receiver Parameters			
4.3.1.10 4.3.2.9	Receiver spurious emissions	PASS	Under limit 11.00 dB at 11340.000 MHz
Adaptive Test Item			
4.3.1.6 4.3.2.5	Adaptivity	PASS	Only applicable for adaptive equipment Output Power >10dBm
4.3.1.11 4.3.2.10	Receiver Blocking	PASS	
Non-Adaptive Test Item			
4.3.1.2 4.3.2.3	Duty cycle, Tx-Sequence, Tx-gap	Not Required	Only applicable for non-adaptive equipment Output Power >10dBm
4.3.1.5 4.3.2.4	Medium Utilisation (MU) factor	Not Required	
Note: Bluetooth belongs to adaptive equipment and EIRP > 10dBm.			



1 General Description

1.1 Applicant

Texas Instruments Incorporated
 12500 TI Boulevard, M/S 8751, Dallas, TX 75243, USA

1.2 Manufacturer

Jorjin Technologies Inc
 17F, No. 239, Sec. 1, Datong Rd., Xizhi Dist., New Taipei City 221, Taiwan

1.3 Product Feature of Equipment Under Test

Product Feature	
Equipment	WiFi and Bluetooth Module
Brand Name	Texas Instruments
Model Name	WL18MODGI
EUT supports Radios application	WLAN 11a/b/g/n HT20/HT40 Bluetooth v4.0 EDR/LE
HW Version	WG7837-T0B
EUT Stage	Identical Prototype

Remark: The above EUT's information was declared by manufacturer. Please refer to the specifications or user's manual for more detailed description.

1.4 Product Specification subjective to this standard

Product Specification subjective to this standard	
Transmitter / Receiver Frequency Range	2402 MHz ~ 2480 MHz
Number of Channels	Bluetooth : 79 Bluetooth 4.0 – LE: 40
Channel Spacing	Bluetooth : 1 MHz Bluetooth 4.0 – LE: 2 MHz
Maximum EIRP Average Power	Bluetooth BR (1Mbps) : 14.20 dBm Bluetooth 4.0 - LE (1Mbps) : 9.90 dBm
Type of Modulation	Bluetooth (1Mbps) : GFSK Bluetooth (2Mbps) : $\pi/4$ -DQPSK Bluetooth (3Mbps) : 8-DPSK Bluetooth LE : GFSK
Power Supply	from laptop

Note: For other wireless features of this EUT, test report will be issued separately.

Antenna Information			
Antenna Type	Brand	2.4GHz~2.5GHz	4.9GHz~5.8GHz
PCB	Ethertronics	-0.6	4.5
Dipole	LSR	2	2
PCB	Laird	2	4
Chip	Pulse	3.2	4.2
PIFA	LSR	2	3
Chip	TDK	2.4	3.96

1.5 Modification of EUT

No modifications are made to the EUT during all test items.

1.6 Testing Facility

Test Site	SPORTON INTERNATIONAL INC.
Test Site Location	No. 52, Hwa Ya 1 st Rd., Hwa Ya Technology Park, Kwei-Shan Hsiang, Tao Yuan Hsien, Taiwan, R.O.C. TEL: +886-3-327-3456 FAX: +886-3-328-4978
Test Site No.	Sporton Site No. : TH02-HY ; 03CH07-HY

Test Site	SPORTON INTERNATIONAL INC.
Test Site Location	No. 13-1&14-1, Lane 19, Wen 33rd St. Kwei-Shan Hsiang, Tao Yuan Hsien, Taiwan, R.O.C. TEL: +886-3-318-0787/+886-3-318-0792 FAX: +886-3-318-0287
Test Site No.	Sporton Site No. : 05CH03-HY



1.7 Applied Standards

According to the specifications of the manufacturer, the EUT must comply with the requirements of **ETSI EN 300 328 V1.8.1 (2012-06)**.

Note: All test items were verified and recorded according to the standards and without any deviation during the test.

1.8 Test Condition

Normal Voltage	DC 5V
Normal Temperature	20°C
Extreme Temperature	-40°C and 85°C

Note: The test temperature was between -40°C ~ 85°C by manufacturer requested.

2 Test Configuration of Equipment under Test

2.1 Descriptions of Test Mode

- a. Preliminary tests were performed in different data rate and recorded the RF power output in the following tables:

Average Bluetooth RF Output Power (dBm)			
Data rate	1Mbps	2Mbps	3Mbps
Avg. Power	10.80	6.70	6.70

Note: Data rate Bluetooth 1Mbps was chosen to be tested due to the highest RF output power.

Average Bluetooth 4.0 - LE RF Output Power (dBm)			
Data Rate	CH 00	CH 19	CH 39
Avg. Power	6.20	6.30	5.70

- b. During radiated spurious emissions testing, the interface cables and equipment positions were varied according to European Standard EN 300 328 V1.8.1 (2012-06), and the frequency range of radiation was investigated from 25 MHz to 12750 MHz.

The following tables for radiated measurement, the worst cases were recorded in this report.

Test Modes	
RF	Bluetooth (1Mbps) GFSK
Tx	Bluetooth (1Mbps) CH00 (2402MHz) for Ant. 1 Bluetooth (1Mbps) CH78 (2480MHz) for Ant. 1
Rx	Bluetooth (1Mbps) CH78 (2480MHz) for Ant. 1

Test Modes	
RF	Bluetooth 4.0 - LE GFSK
Tx	Bluetooth 4.0 - LE CH00 (2402MHz) for Ant. 1 Bluetooth 4.0 - LE CH39 (2480MHz) for Ant. 1
Rx	Bluetooth 4.0 - LE CH39 (2480MHz) for Ant. 1

Remark: All test modes of the Transmitter Radiated Spurious Emission (RSE) and Receiver Radiated Spurious Emission (RSE) were tested; only the test worse data in bold of these modes were reported.

2.2 Connection Diagram of EUT Test Configurations

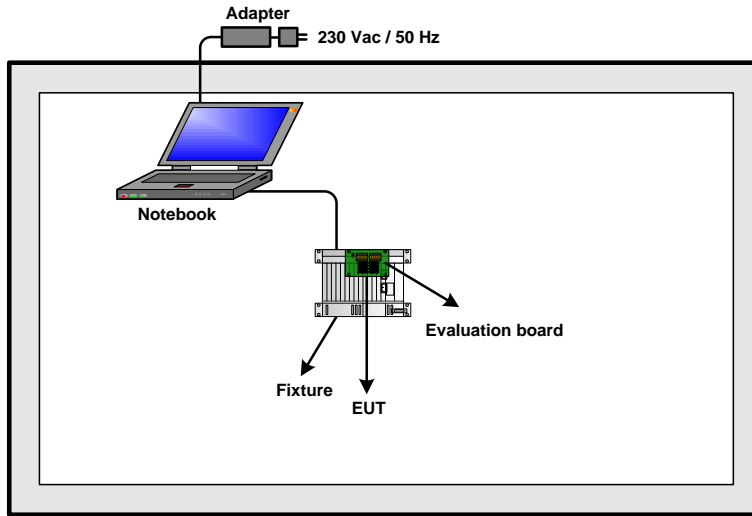

2.3 Supported Unit used in test configuration and system

Item	Equipment	Trade Name	Model Name	FCC ID	Data Cable	Power Cord
1.	Notebook	DELL	Latitude E6320	FCC DoC/ Contains FCC ID: QDS-BRCM1054	N/A	AC I/P: Unshielded, 1.2 m DC O/P: Shielded, 1.8 m
2.	Fixture	N/A	N/A	N/A	N/A	N/A
3.	Evaluation board	N/A	WG1300BE00	N/A	N/A	N/A

2.4 EUT Operation Test Setup

For Bluetooth and Bluetooth 4.0 – LE function, the RF utility, “HCtest” was installed in notebook which was programmed in order to make the EUT into the engineering modes for continuous transmitting and receiving signals.

3 Transmitter Parameters

3.1 Maximum Transmit Power

3.1.1 Limit of Effective Isotropic Radiated Power

SUBCLAUSE 4.3.1.1.2 and 4.3.2.1.2	
TEST CONDITION	LIMIT
Normal and Extreme Temperature Conditions	20dBm (e.i.r.p)

3.1.2 Measuring Instruments

The measuring equipment is listed in the section 7 of this test report.

3.1.3 Test Procedure

1. The measurement procedure follows the clause 5.3.2.2.1 of the ETSI EN 300 328 V1.8.1 (2012-06).
2. Placing the EUT in thermal chamber.
3. The EUT is connected to external power supply.
4. Setting thermal chamber temperature and power supply voltage at suitable values.
5. The EIRP = A+G+Y, where A is the power measured, G is the assembly gain of the individual antenna of the EUT in dBi and Y is the additional beamforming gain of the EUT in dB if applicable, here, Y=0.
6. The measurement duration is at least 1 second to ensure a minimum number of bursts (at least 10) are captured.

3.1.4 Test Setup

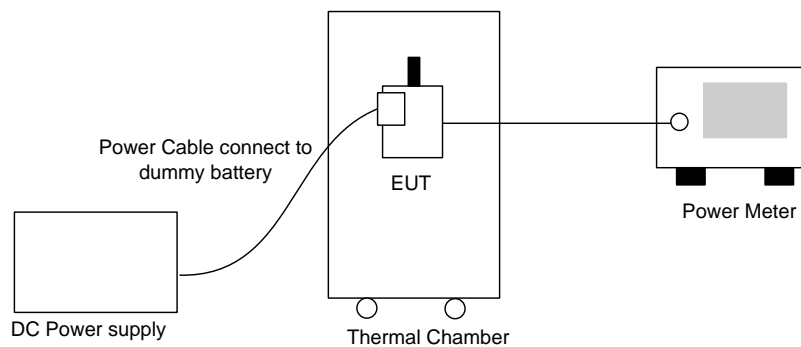



3.1.5 Test Results

Test Item :	EIRP Power	Temperature :	21~26°C
Test Engineer :	Alex Lee	Relative Humidity :	48~51%

Mod.	Data Rate	N _{TX}	Channel	Freq. (MHz)	Conducted Power (dBm)			Gain (dBi)	
					T nom	T min	T max		
					20 °C	-40 °C	85 °C		
BT Nom	1Mbps	1	0	2402	10.80	11.00	10.00	3.20	
BT Nom	1Mbps	1	39	2441	10.50	10.80	9.70	3.20	
BT Nom	1Mbps	1	78	2480	10.20	10.60	9.40	3.20	
BLE	1Mbps	1	0	2402	6.20	6.60	5.90	3.20	
BLE	1Mbps	1	19	2440	6.30	6.70	5.90	3.20	
BLE	1Mbps	1	39	2480	5.70	6.40	5.40	3.20	

Mod.	Data Rate	N _{TX}	Channel	Freq. (MHz)	EIRP Power (dBm)			Power Limit (dBm)	Pass/Fail
					T nom	T min	T max		
					20 °C	-40 °C	85 °C		
BT Nom	1Mbps	1	0	2402	14.00	14.20	13.20	20	Pass
BT Nom	1Mbps	1	39	2441	13.70	14.00	12.90	20	Pass
BT Nom	1Mbps	1	78	2480	13.40	13.80	12.60	20	Pass
BLE	1Mbps	1	0	2402	9.40	9.80	9.10	20	Pass
BLE	1Mbps	1	19	2440	9.50	9.90	9.10	20	Pass
BLE	1Mbps	1	39	2480	8.90	9.60	8.60	20	Pass

Note: EIRP = measured average conducted power(burst) + antenna gain.

3.2 Maximum Equivalent Isotropically Radiated Power (E.I.R.P.) Spectral Density

3.2.1 Limit of Maximum Power Spectral Density

SUBCLAUSE 4.3.2.2.2	
TEST CONDITION	LIMIT
Normal and Extreme Temperature Conditions	10dBm / MHz

Remark: Maximum spectral power density is not applicable to FHSS system device.

3.2.2 Measuring Instruments

The measuring equipment is listed in the section 7 of this test report.

3.2.3 Test Procedure

1. The measurement procedure follows the clause 5.3.3.2.1 of the ETSI EN 300 328 V1.8.1 (2012-06).
2. These measurements shall only be performed at normal test conditions.
3. The measurement shall be repeated for the equipment being configured to operate at the lowest, the middle, and the highest frequency of the stated frequency range.
4. The test procedure shall be as follows:

Step 1:

Connect the EUT to the spectrum analyzer and use the following settings:

Start Frequency	2400MHz
Stop Frequency	2483.5MHz
Resolution BW	10kHz
Video BW	30kHz
Sweep Points	8350
Detector	RMS
Trace Mode	Max Hold
Sweep time	Auto

Step 2:

Add up the values for amplitude (power) for all the samples in the file.

Step 3:

Normalize the individual values for amplitude so that the sum is equal to the RF Output Power (e.i.r.p.) measured.

Step 4:

Starting from the first sample in the file (lowest frequency), add up the power of the following samples representing a 1 MHz segment and record the results for power and position (i.e. sample #1 to #100). This is the Power Spectral Density (e.i.r.p.) for the first 1 MHz segment which shall be recorded.

Step 5:

Shift the start point of the samples added up in step 4 by 1 sample and repeat the procedure in step 4 (i.e. sample #2 to #101).

Step 6:

Repeat step 5 until the end of the data set and record the radiated Power Spectral Density values for each of the 1 MHz segments.

From all the recorded results, the highest value is the maximum Power Spectral Density for the EUT. This value shall be recorded in the test report.

3.2.4 Test Setup

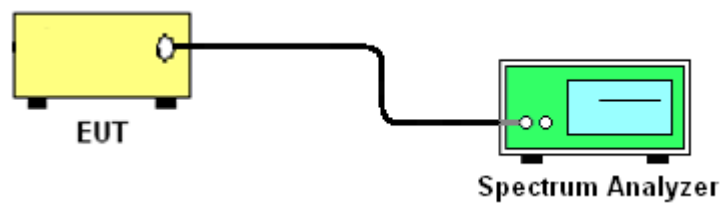

3.2.5 Test Results

Test Item :	EIRP Power Density		Temperature :	21~26°C					
Test Engineer :	Alex Lee		Relative Humidity :	48~51%					

Mod.	Data Rate	N _{TX}	Channel	Freq. (MHz)	Conducted Power Density (dBm/MHz)	Ant Gain (dBi)	EIRP Power Density (dBm/MHz)	Max. Limits (dBm/MHz)	Pass/Fail
BLE	1Mbps	1	0	2402	6.15	3.20	9.35	10	Pass
BLE	1Mbps	1	19	2440	6.24	3.20	9.44	10	Pass
BLE	1Mbps	1	39	2480	5.64	3.20	8.84	10	Pass

3.3 Occupied Channel Bandwidth

3.3.1 Limit of Occupied Channel Bandwidth

Occupied Channel Bandwidth fall completely within 2.4 GHz – 2.4835 GHz

3.3.2 Measuring Instruments

The measuring equipment is listed in the section 7 of this test report.

3.3.3 Test Procedure

1. The measurement procedure follows the clause 5.3.8.2.1 of the ETSI EN 300 328 V1.8.1 (2012-06).
2. The measurement shall be performed only on the lowest and the highest frequency within the stated frequency range.
3. The test procedure shall be as follows:

Step 1:

Connect the EUT to the spectrum analyzer and use the following settings:

Center Frequency	Channel under test
Resolution BW	1 % of the span
Video BW	3 × RBW
Frequency Span	2 × Occupied Channel Bandwidth (e.g. 40 MHz for a 20 MHz channel)
Detector	RMS
Trace Mode	Max Hold

Step 2:

Wait until the trace is completed.

Find the peak value of the trace and place the analyzer marker on this peak.

Step 3:

Use the 99 % bandwidth function of the spectrum analyzer to measure the Occupied Channel Bandwidth of the EUT.

3.3.4 Test Setup

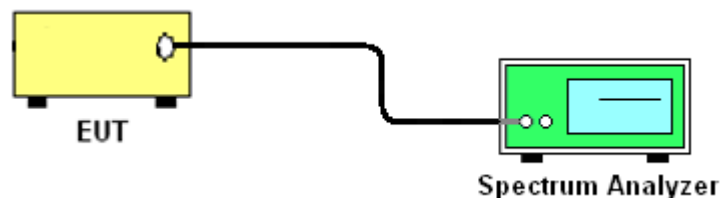



3.3.5 Test Results

Test Item :	99% Occupied BW	Temperature :	21~26°C
Test Engineer :	Alex Lee	Relative Humidity :	48~51%

Mod.	Data Rate	N _{TX}	Chain Port	Ch.	Freq. (MHz)	99% OBW (MHz)	FL (MHz)	FH (MHz)	Limit (Within operating Band)	Pass/Fail
BT Nom	1Mbps	1	1	0	2402	0.84	2401.59	2402.42	-	Pass
BT Nom	1Mbps	1	1	78	2480	0.83	2479.59	2480.42	-	Pass
BT Nom	2Mbps	1	1	0	2402	1.17	2401.41	2402.58	-	Pass
BT Nom	2Mbps	1	1	78	2480	1.19	2479.39	2480.59	-	Pass
BT Nom	3Mbps	1	1	0	2402	1.16	2401.41	2402.57	-	Pass
BT Nom	3Mbps	1	1	78	2480	1.17	2479.41	2480.57	-	Pass
BLE	1Mbps	1	1	0	2402	1.03	2401.49	2402.52	-	Pass
BLE	1Mbps	1	1	39	2480	1.04	2479.49	2480.52	-	Pass

3.4 Frequency Hopping Requirements

3.4.1 Dwell Time and Minimum Frequency Occupation Time

3.4.1.1 Limit of Dwell Time

SUBCLAUSE 4.3.1.3.2	
TEST CONDITION	LIMIT
Non-Adaptive Frequency Hopping Systems	15 ms within 15ms * hopping frequencies (N)
Adaptive Frequency Hopping Systems	0.4s within 0.4s * hopping frequencies (N)

Limit of Minimum Frequency Occupation Time

SUBCLAUSE 4.3.1.3.2	
TEST CONDITION	LIMIT
Normal and Extreme Temperature Conditions	The Minimum Frequency Occupation Time shall be equal to one dwell time within a period not exceeding four times the product of the dwell time per hop and the number of hopping frequencies in use.

Remark: This test item is not applicable to DSSS/OFDM device.

3.4.1.2 Measuring Instruments

The measuring equipment is listed in the section 7 of this test report.

3.4.1.3 Test Procedures

1. The measurement shall be performed on a minimum of 2 hopping frequencies chosen arbitrary from the actual hopping sequence. The results as well as the frequencies on which the test was performed shall be recorded in the test report.
2. The measurement procedure follows the clause 5.3.4.2.1 of the ETSI EN 300 328 V1.8.1 (2012-06).
3. The analyzer shall be set as follows:

Center Frequency	Channel under test
Frequency Span	0 Hz
Resolution BW	300kHz
Video BW	300kHz
Detector	RMS
Sweep time	Equal to the Dwell Time × Minimum number of hopping frequencies (N)
Number of sweep points	30000
Trace Mode	Clear / Write
Trigger	Free Run

4. For accuracy measurement, the sweep time would be zoomed in and verify the dwell time which is from the dwell time per hop across the total number of hopping channel. Then record test result in the section 3.4.1.5.
5. Make the following changes on the analyzer to get Minimum Frequency Occupation Time Sweep time: Equal to 4 x Dwell Time x Actual number of hopping frequencies in use

3.4.1.4 Test Setup

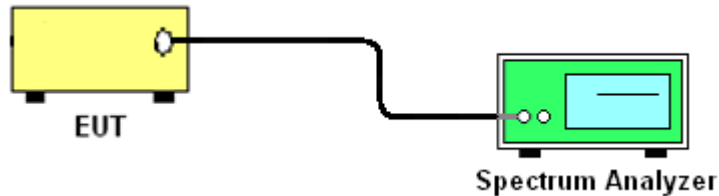

3.4.1.5 Test Results

Test Item :	Dwell Time and Occupation time	Temperature :	21~26°C
Test Engineer :	Alex Lee	Relative Humidity :	48~51%

	BT (Hopping Mode)	Dwell Time per hop(ms)	Dwell Time(ms)	Dwell Time Max. Limit (ms)	Frequency Occupation		Frequency Occupation Time min. Limit (ms)	Pass /Fail
					Hop #	Time(ms)		
DH1	2402 MHz	0.41	129.74	400	1	0.41	0.41	Pass
	2480 MHz	0.41	130.56	400	2	0.82	0.41	Pass
DH3	2402 MHz	1.67	272.81	400	2	3.34	1.67	Pass
	2480 MHz	1.67	286.51	400	4	6.68	1.67	Pass
DH5	2402 MHz	2.92	307.57	400	3	8.76	2.92	Pass
	2480 MHz	2.92	306.52	400	4	11.68	2.92	Pass

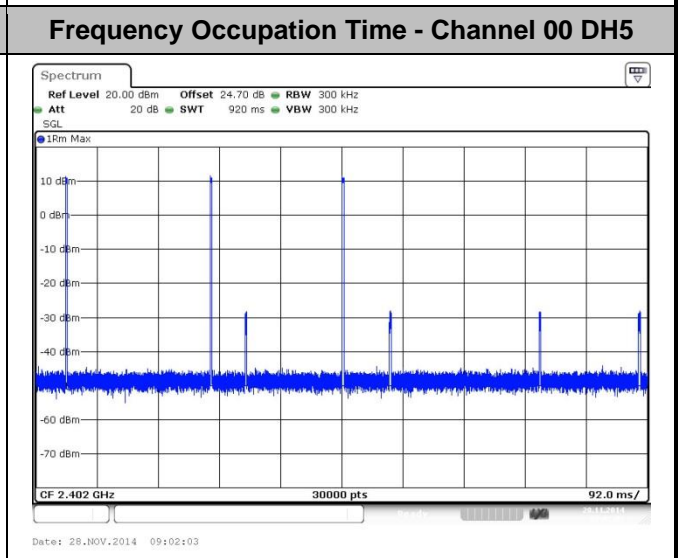
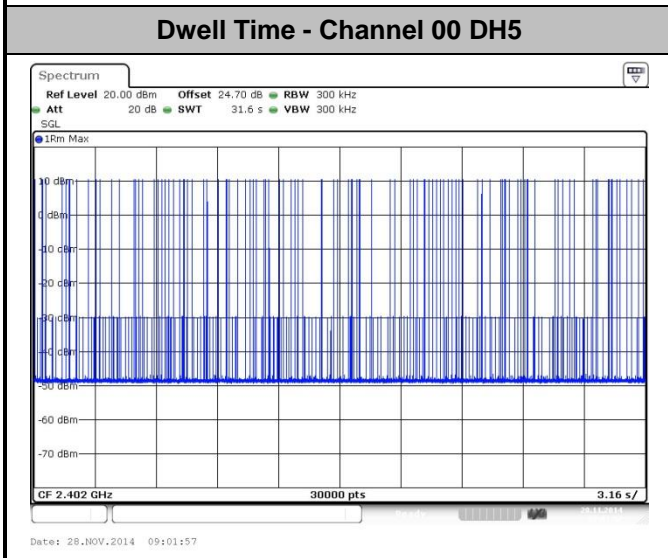
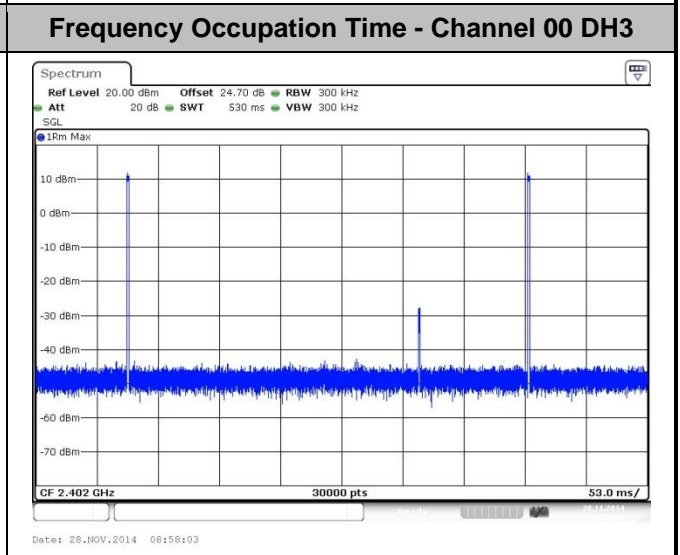
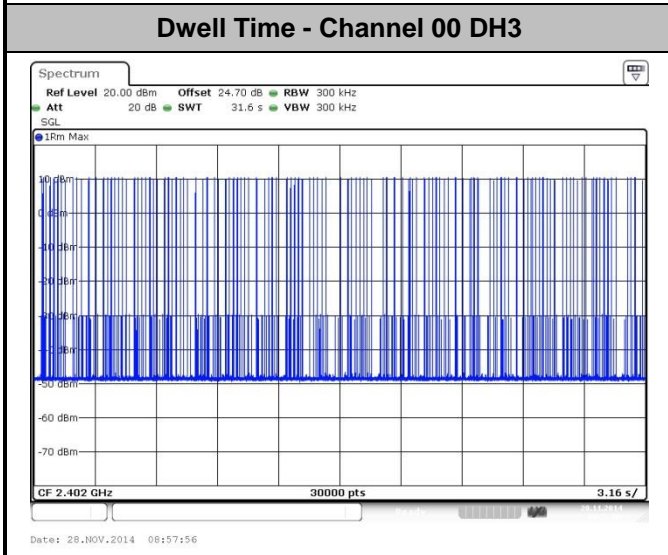
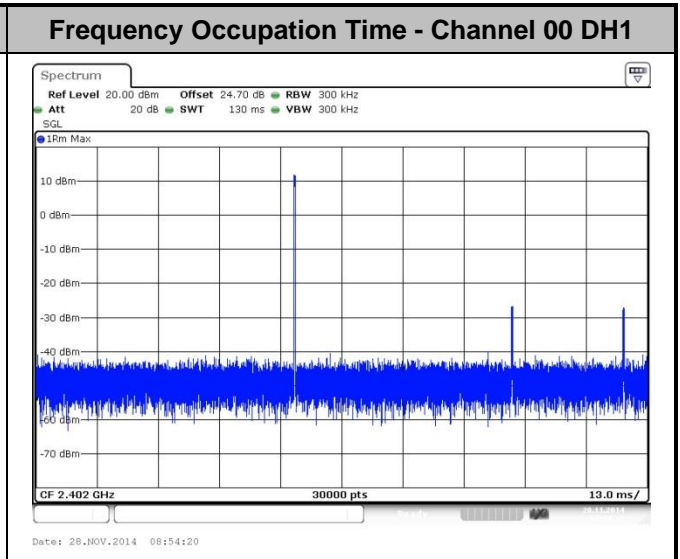
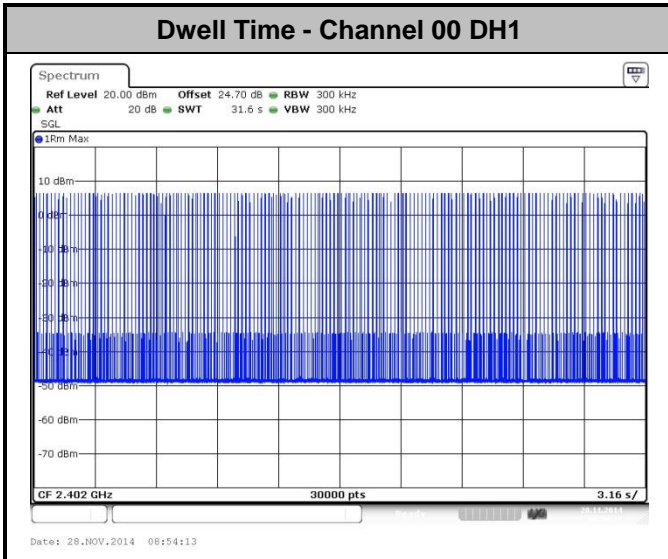

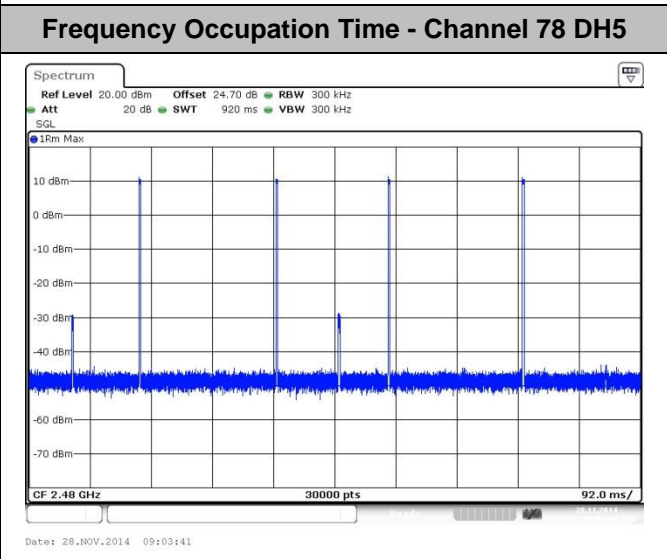
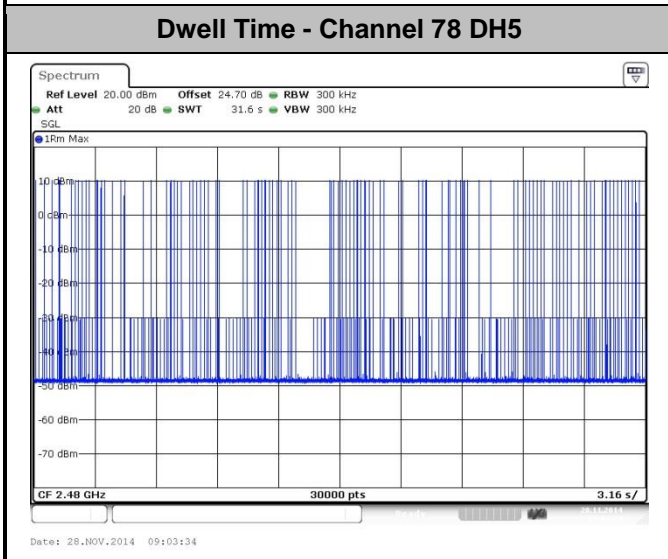
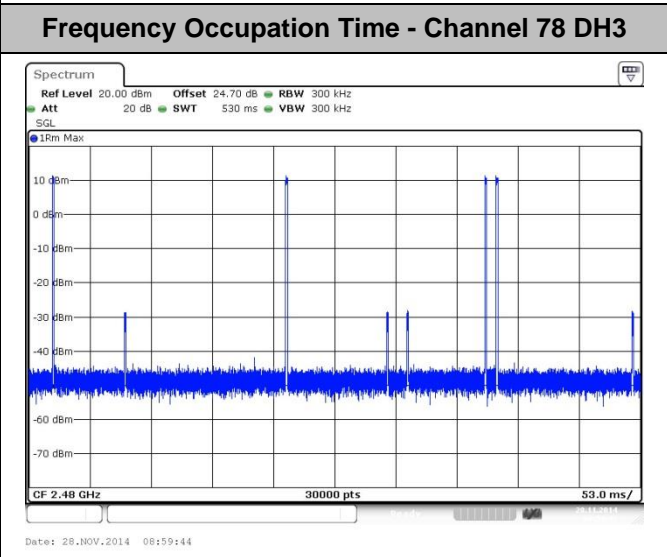
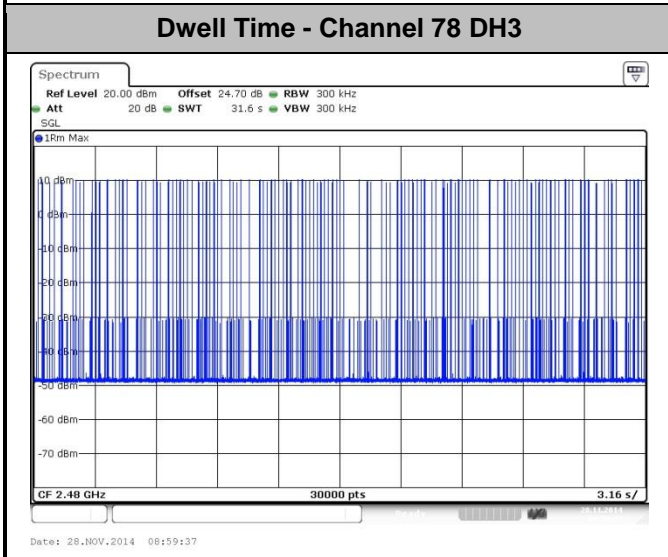
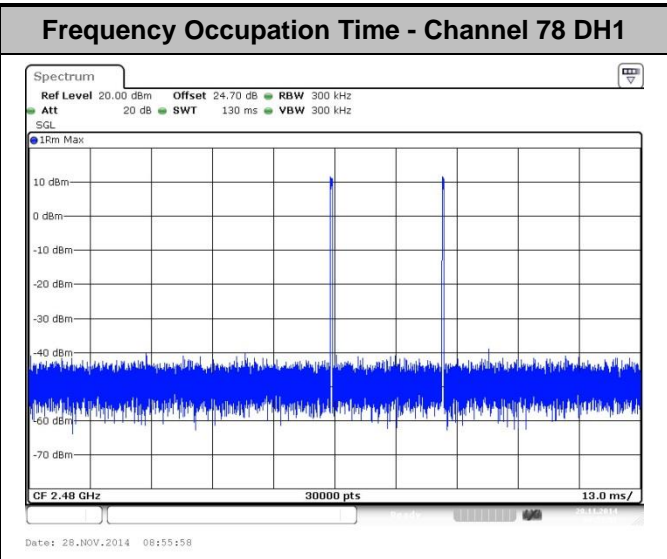
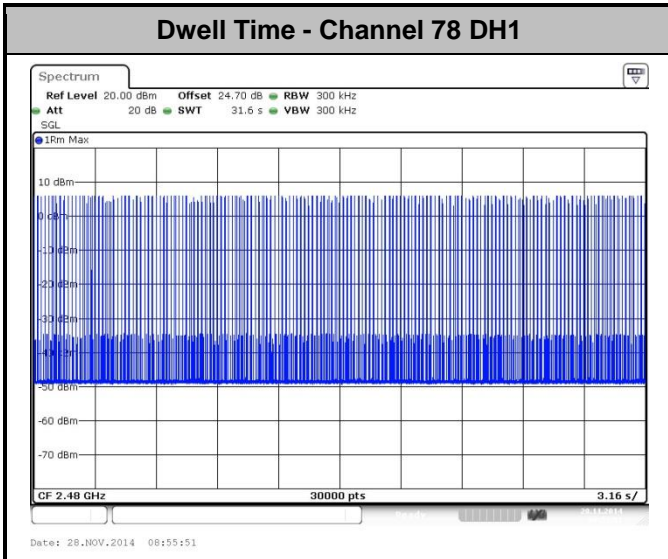

3.4.2 Hopping Sequence

3.4.2.1 Limit of Hopping Sequence

SUBCLAUSE 4.3.1.3.2	
TEST CONDITION	LIMIT
Non-Adaptive Frequency Hopping Systems	N
Adaptive Frequency Hopping Systems	N Ch 70% of band

N= 15 or 15 divided by the minimum Hopping Frequency Separation in MHz, whichever is the greater.

Remark: Hopping Sequence is not applicable to DSSS/OFDM device.

3.4.2.2 Measuring Instruments

The measuring equipment is listed in the section 7 of this test report.

3.4.2.3 Test Procedures

The measurement procedure follows the clause 5.3.4.2.1 of the ETSI EN 300 328 V1.8.1 (2012-06).

3.4.2.4 Test Setup

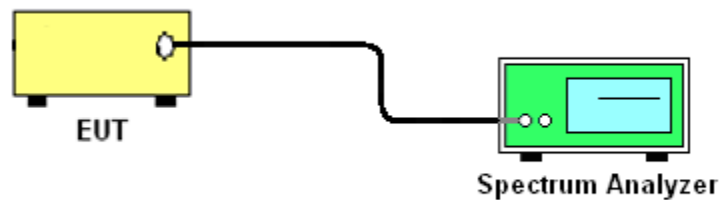

3.4.2.5 Test Results

Test Item:	Hopping Sequence	Temperature :	21~26°C
Test Engineer :	Alex Lee	Relative Humidity :	48~51%

Total Number of Hopping Frequency	Limit of operating channel (at least 70% of band)	Minimum Number of Adaptive Frequency Hopping	Limit of hopping frequencies at all times
79	59	20	15



Total Number of Hopping Channel Plot on Channel 00 - 78

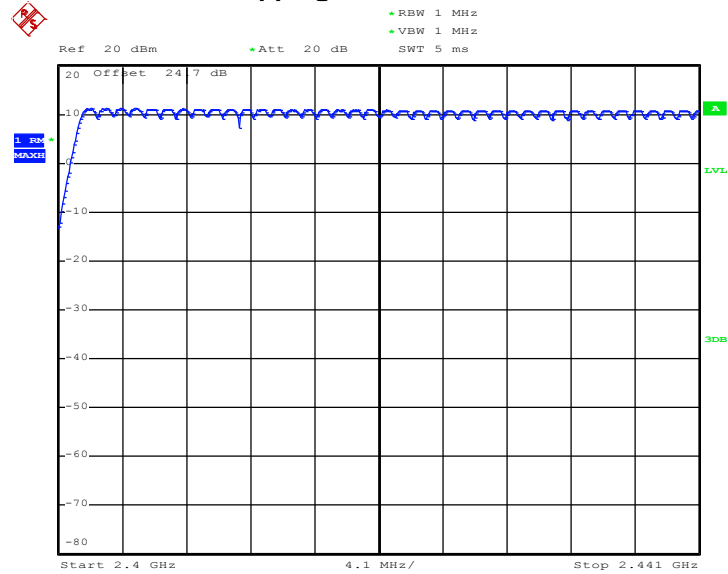

Date: 28.NOV.2014 10:43:46

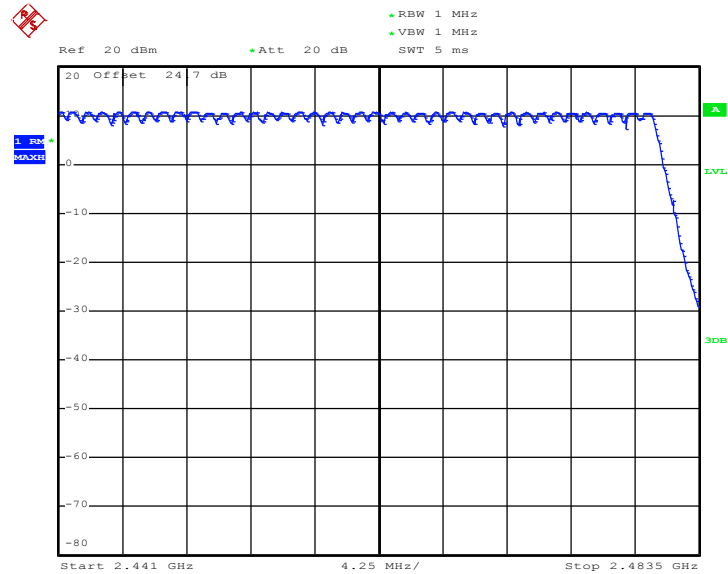

Date: 28.NOV.2014 10:44:43

3.4.3 Hopping Frequency Separation

3.4.3.1 Limit of Hopping Frequency Separation

SUBCLAUSE 4.3.1.4.2	
TEST CONDITION	LIMIT
Non-Adaptive Frequency Hopping Systems	MAX [OBW, 100kHz]
Adaptive Frequency Hopping Systems	100kHz

Remark: Hopping Frequency Separation is not applicable to DSSS/OFDM device.

3.4.3.2 Measuring Instruments

The measuring equipment is listed in the section 7 of this test report.

3.4.3.3 Test Procedures

1. These measurements shall only be performed at normal test conditions.
2. The measurement shall be performed on 2 adjacent hopping frequencies.
3. The frequencies on which the test was performed shall be recorded.
4. The measurement procedure follows the clause 5.3.5.2.1.2 Option 2 of the ETSI EN 300 328 V1.8.1 (2012-06).

3.4.3.4 Test Setup



3.4.3.5 Test Results

Test Item :	Frequency Separation	Temperature :	21~26°C
Test Engineer :	Alex Lee	Relative Humidity :	48~51%

BT	Separation(MHz)	Limit(MHz)
CH 00	1.002	>0.1
CH 39	1.002	>0.1
CH 78	0.999	>0.1

3.5 Transmitter unwanted emissions in the out-of-band domain

3.5.1 Transmitter unwanted emissions in the out-of-band domain limit

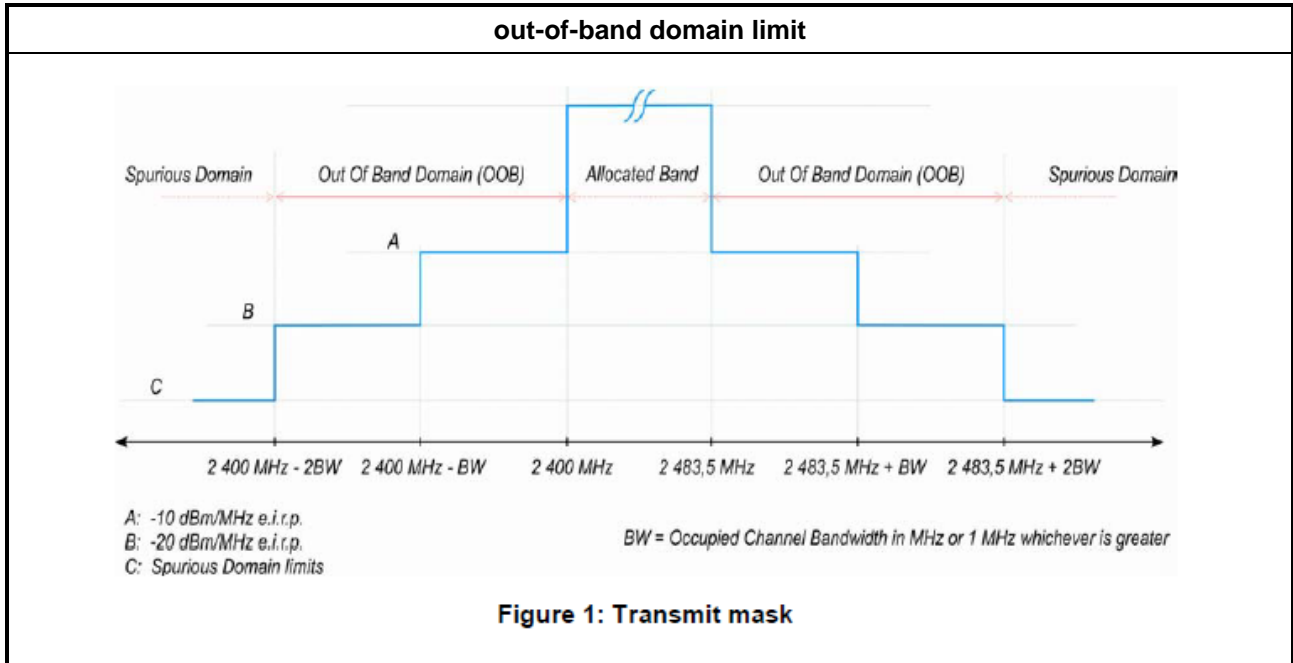

3.5.2 Measuring Instruments

The measuring equipment is listed in the section 7 of this test report.

3.5.3 Test Procedures

1. The measurement procedure follows the clause 5.3.9.2.1 of the ETSI EN 300 328 V1.8.1 (2012-06).
2. The measurements shall be performed at both normal environmental conditions and at the extremes of the operating temperature range.
3. For conducted measurements on devices with multiple transmit chains using the results for each of the transmit chains for the corresponding 1 MHz segments shall be added and compared with the transmit mask limit.

3.5.4 Test Setup

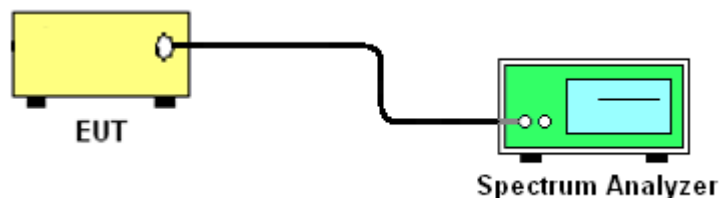



3.5.5 Test Results

Test Item :	OOB Emissions	Temperature :	21~26°C
Test Engineer :	Alex Lee	Relative Humidity :	48~51%

Mod.	Data Rate	N _{TX}	Channel	Freq. (MHz)	Temperature Normal	Extreme Temperature Low	Extreme Temperature High	Limit (dBm/MHz)	Pass/Fail
					T nom	T min	T max		
					20 °C	-40 °C	85 °C		
BT Nom	1Mbps	1	0	hop	-23.66	-31.89	-29.85	-10,-20	Pass
BT Nom	2Mbps	1	0	hop	-29.56	-25.82	-28.04	-10,-20	Pass
BT Nom	3Mbps	1	0	hop	-30.39	-28.88	-29.36	-10,-20	Pass
BLE	1Mbps	1	00	2402	-21.02	-20.46	-22.80	-10,-20	Pass
BLE	1Mbps	1	39	2480	-34.41	-33.70	-36.02	-10,-20	Pass

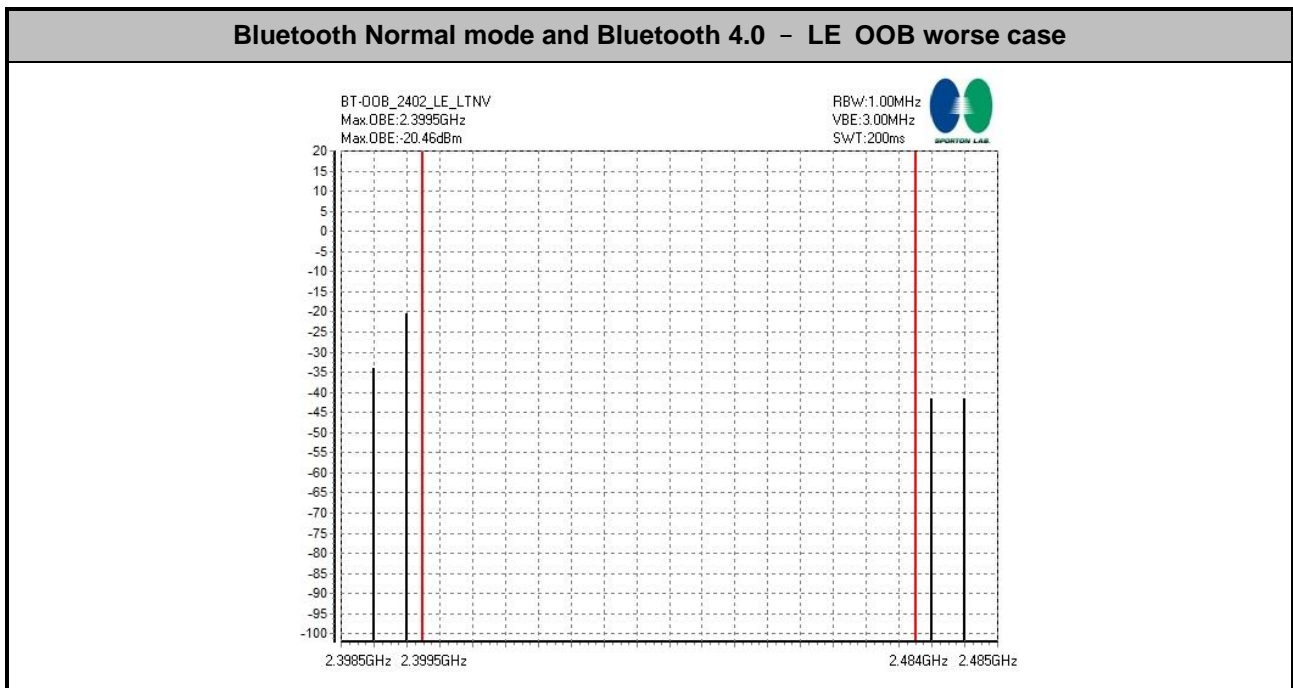

Note: Normal and extreme condition can refer to the section 1.7 of this test report.

3.6 Transmitter spurious emissions

3.6.1 Limit of Transmitter spurious emissions

Spurious emission limits for transmitter:

SUBCLAUSE 4.3.1.9.2 and 4.3.2.8.2		
FREQUENCY RANGE	MAXIMUM POWER E.R.P. (\leq 1 GHZ) E.I.R.P. ($>$ 1 GHZ)	BANDWIDTH
30 MHz to 47 MHz	-36 dBm	100 kHz
47 MHz to 74 MHz	-54 dBm	100 kHz
74 MHz to 87,5 MHz	-36 dBm	100 kHz
87,5 MHz to 118 MHz	-54 dBm	100 kHz
118 MHz to 174 MHz	-36 dBm	100 kHz
174 MHz to 230 MHz	-54 dBm	100 kHz
230 MHz to 470 MHz	-36 dBm	100 kHz
470 MHz to 862 MHz	-54 dBm	100 kHz
862 MHz to 1 GHz	-36 dBm	100 kHz
1 GHz to 12,75 GHz	-30 dBm	1 MHz

3.6.2 Measuring Instruments

The measuring equipment is listed in the section 7 of this test report.

3.6.3 Test Procedures

1. The measurement procedure follows the clause 5.3.10.2.2 of the ETSI EN 300 328 V1.8.1 (2012-06).
2. The EUT was placed on a turntable with 1.5m height.
3. The test distance between the receiving antenna and the EUT is 3meter below 1GHz frequency range, and 3 meter which is in far field test condition for measured frequency above 1GHz, while the receiving (test) antenna is kept at 1.5 meter height.
4. Set EUT in continuous transmitting with maximum output power.
5. The table was rotated from 0 to 360 degree to search the highest radiated emission.
6. Repeating step 3 and 4 for each polarization and channel to find the worst emission level.
7. The results obtained are compared to the limits in order to prove compliance with the requirement.

3.6.4 Test Setup

Conducted Test Setup:



Radiated Test Setup:

<Below 1GHz>

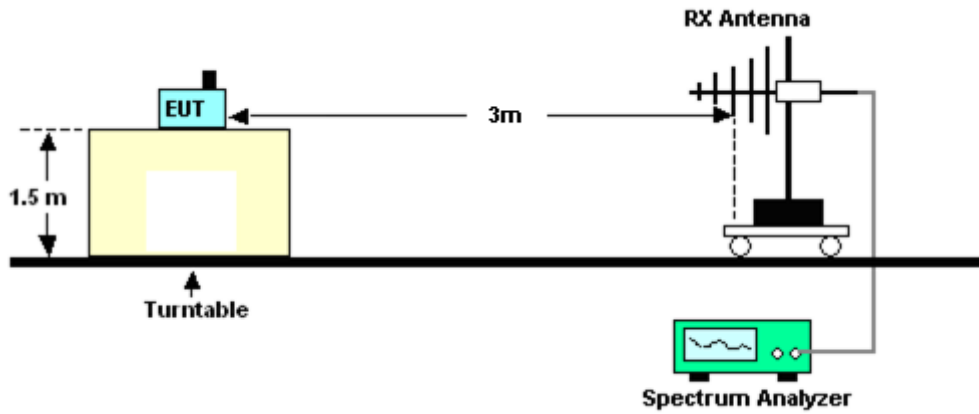

<Above 1GHz>

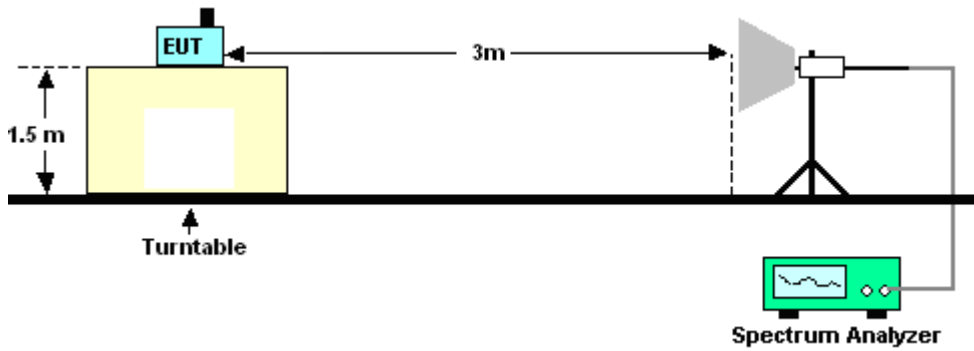



3.6.5 Test Results for Conducted Setup

Test Mode :	Bluetooth (1Mbps) CH00 (2402MHz) for Ant. 1	Temperature :	24~26°C
Test Engineer :	Eric Shih	Relative Humidity :	42~44%

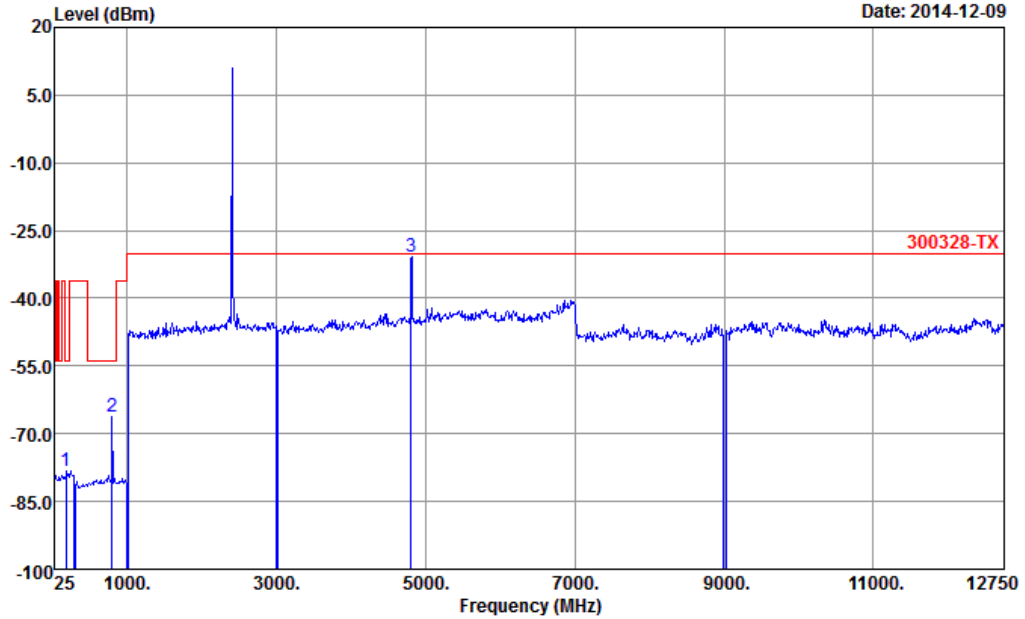

Site : 03CH07-HY
 Condition : 300328-TX ANT GAIN+3.2 2.4G

	Freq	Level	Over	Limit	ReadAntenna	Cable	Aux	Aux2	Remark
	MHz	dBm	Limit	Line	Level	Loss	Factor	Factor	
			dB	dBm	dBm	dB	dB	dB	
1	184.78	-78.14	-24.14	-54.00	-83.84	3.20	2.50	0.00	0.00 RMS
2	800.50	-66.24	-12.24	-54.00	-71.94	3.20	2.50	0.00	0.00 RMS
3	4806.00	-30.67	-0.67	-30.00	-36.37	3.20	2.50	0.00	0.00 RMS



Test Mode :	Bluetooth 4.0 - LE CH39 (2480MHz) for Ant. 1	Temperature :	24~26°C
Test Engineer :	Eric Shih	Relative Humidity :	42~44%

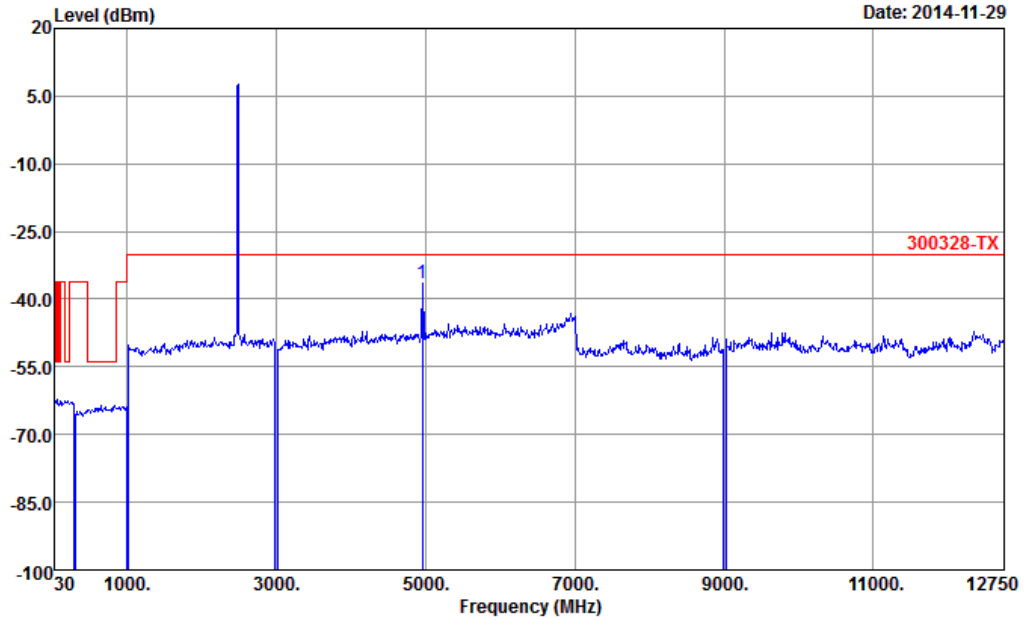

Site : 03CH07-HY
 Condition : 300328-TX ANT GAIN+3.2 2.4G

	Freq	Level	Over	Limit	ReadAntenna	Cable	Aux	Aux2	Remark
	MHz	dBm	dB	dBm	dBm	dB	dB	dB	
1	4962.00	-36.35	-6.35	-30.00	-42.05	3.20	2.50	0.00	0.00 RMS



3.6.6 Test Results for Radiated Setup (Cabinet Radiation)

Test Mode :	Bluetooth (1Mbps) CH78 (2480MHz) for Ant. 1	Temperature :	23~24°C
Test Engineer :	Pony Chen	Relative Humidity :	43~44%
		Polarization :	Horizontal

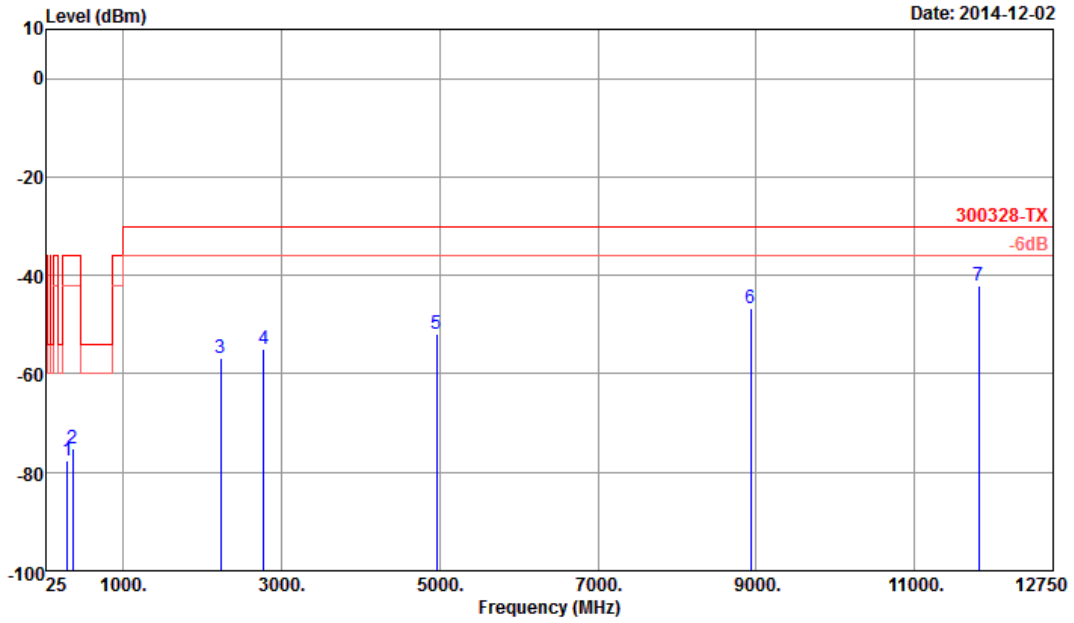

Site : 05CH03-HY
 Condition : 300328-TX HORIZONTAL
 Power : From System

	Freq	Level	Over Limit	Limit Line	Read Level	Factor	Pol/Phase
	MHz	dBm	dB	dBm	dBm	dB	
1	298.90	-77.55	-41.55	-36.00	-65.18	-12.37	HORIZONTAL
2	361.60	-75.20	-39.20	-36.00	-65.15	-10.05	HORIZONTAL
3	2236.00	-56.92	-26.92	-30.00	-65.11	8.19	HORIZONTAL
4	2776.00	-55.10	-25.10	-30.00	-64.71	9.61	HORIZONTAL
5	4959.00	-51.80	-21.80	-30.00	-67.09	15.29	HORIZONTAL
6	8928.00	-46.69	-16.69	-30.00	-71.04	24.35	HORIZONTAL
7 @	11808.75	-42.15	-12.15	-30.00	-71.01	28.86	HORIZONTAL



Test Mode :	Bluetooth (1Mbps) CH78 (2480MHz) for Ant. 1	Temperature :	23~24°C
Test Engineer :	Pony Chen	Relative Humidity :	43~44%
		Polarization :	Vertical

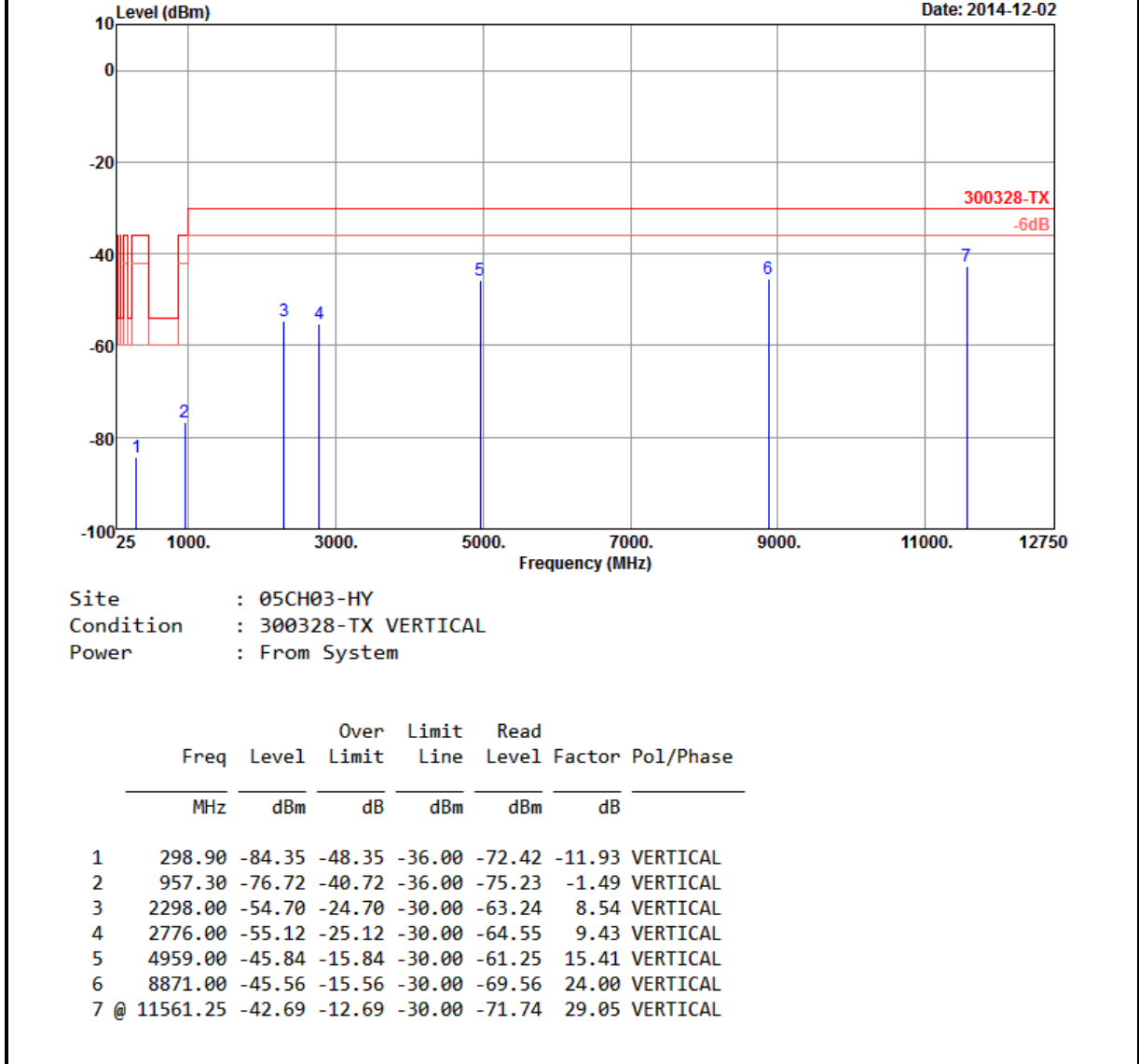



Test Mode :	Bluetooth 4.0 - LE CH39 (2480MHz) for Ant. 1	Temperature :	23~24°C
Test Engineer :	Pony Chen	Relative Humidity :	43~44%
		Polarization :	Horizontal

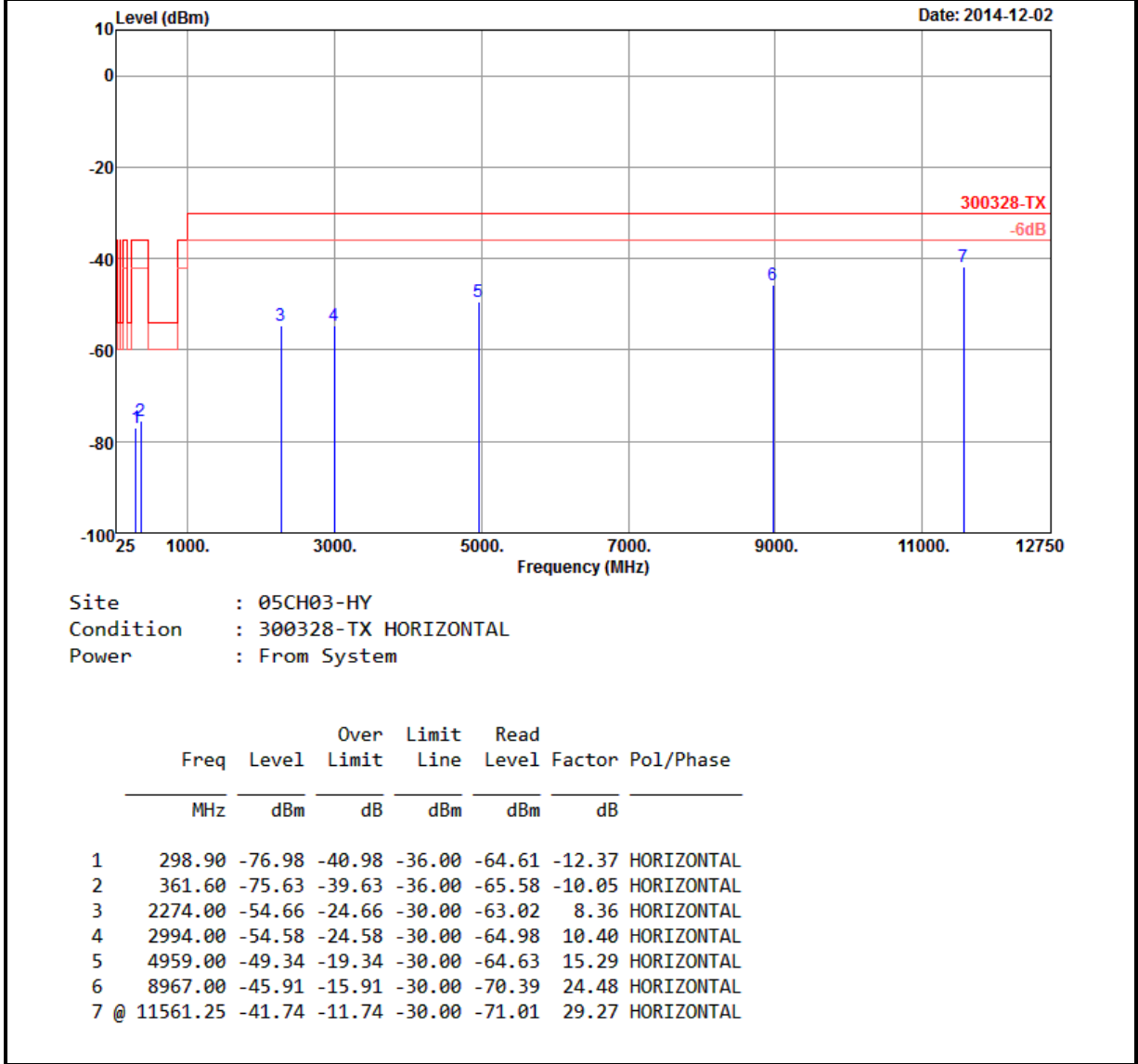



Test Mode :	Bluetooth 4.0 - LE CH39 (2480MHz) for Ant. 1	Temperature :	23~24°C
Test Engineer :	Pony Chen	Relative Humidity :	43~44%
		Polarization :	Vertical

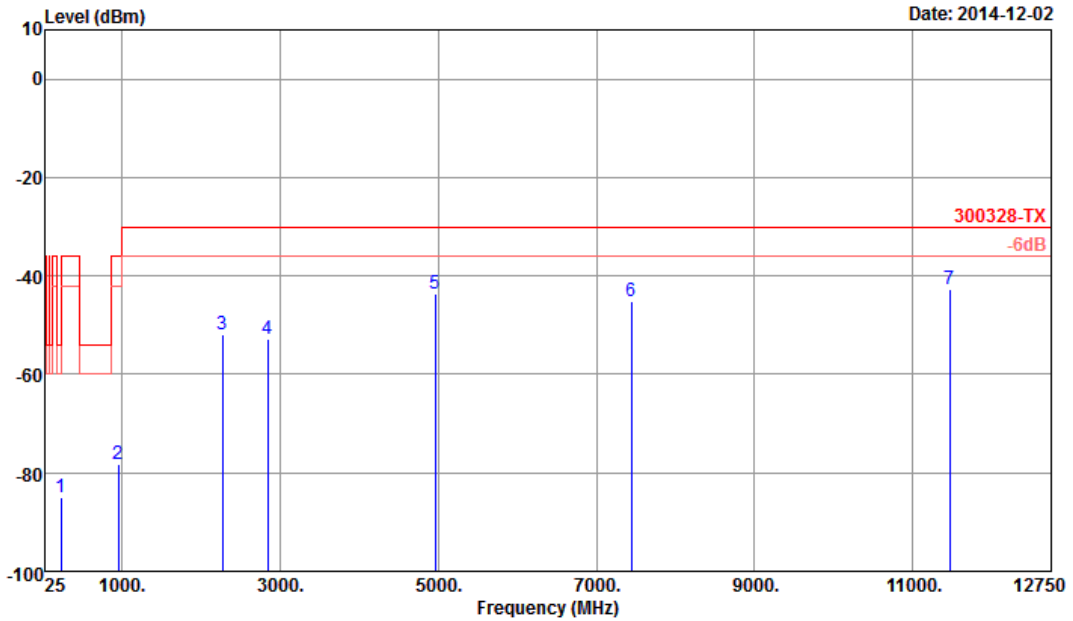

Site : 05CH03-HY
 Condition : 300328-TX VERTICAL
 Power : From System

	Freq	Level	Over Limit	Limit Line	Read Level	Factor	Pol/Phase
	MHz	dBm	dB	dBm	dBm	dB	
1	232.90	-84.94	-48.94	-36.00	-69.59	-15.35	VERTICAL
2	957.30	-78.16	-42.16	-36.00	-76.67	-1.49	VERTICAL
3	2276.00	-52.01	-22.01	-30.00	-60.44	8.43	VERTICAL
4	2846.00	-52.86	-22.86	-30.00	-62.60	9.74	VERTICAL
5	4959.00	-43.59	-13.59	-30.00	-59.00	15.41	VERTICAL
6	7440.00	-45.25	-15.25	-30.00	-68.38	23.13	VERTICAL
7 @	11471.25	-42.61	-12.61	-30.00	-71.70	29.09	VERTICAL

4 Receiver Parameters

4.1 Receiver spurious emissions

4.1.1 Limit of Receiver spurious emissions

FHSS spurious emission limits for receivers:

SUBCLAUSE 4.3.1.10.2		
FREQUENCY RANGE	MAXIMUM POWER E.R.P. (\leq 1 GHz) E.I.R.P. ($>$ 1 GHz)	MEASUREMENT BANDWIDTH
30 MHz to 1 GHz	-57 dBm	100kHz
1 GHz to 12,75 GHz	-47 dBm	1MHz

WLAN spurious emission limits for receivers

SUBCLAUSE 4.3.2.9		
FREQUENCY RANGE	MAXIMUM POWER, E.R.P.	MEASUREMENT BANDWIDTH
30 MHz to 1 GHz	-57 dBm	100kHz
1 GHz to 12,75 GHz	-47 dBm	1MHz

4.1.2 Measuring Instruments

The measuring equipment is listed in the section 7 of this test report.

4.1.3 Test Procedures

1. The measurement procedure follows the clause 5.3.11.2.2 of the ETSI EN 300 328 V1.8.1 (2012-06).
2. The EUT was placed on a turntable with 1.5m height.
3. The test distance between the receiving antenna and the EUT is 3meter below 1GHz frequency range, and 3 meter which is in far field test condition for measured frequency above 1GHz, while the receiving (test) antenna is kept at 1.5 meter height.
4. Set EUT in receiving mode.
5. The table was rotated from 0 to 360 degree to search the highest radiated emission.
6. Repeating step 3 and 4 for each polarization and channel to find the worst emission level.
7. The results obtained are compared to the limits in order to prove compliance with the requirement.

4.1.4 Test Setup

Conducted Test Setup:



Radiated Test Setup:

<Below 1GHz>

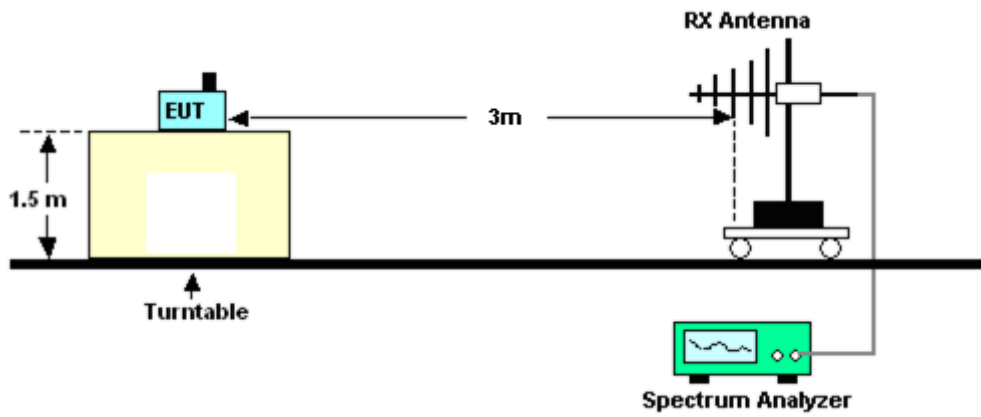

<Above 1GHz>

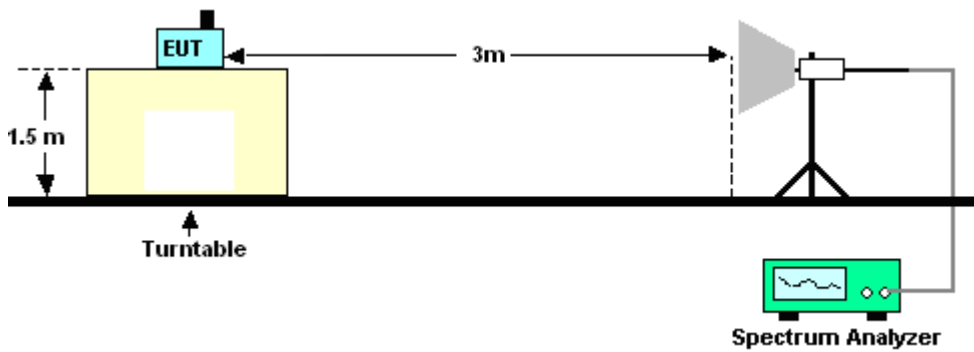



4.1.5 Test Results for Conducted Setup

Test Mode :	Bluetooth (1Mbps) CH00 (2402MHz) for Ant. 1	Temperature :	24~26°C
Test Engineer :	Eric Shih	Relative Humidity :	42~44%

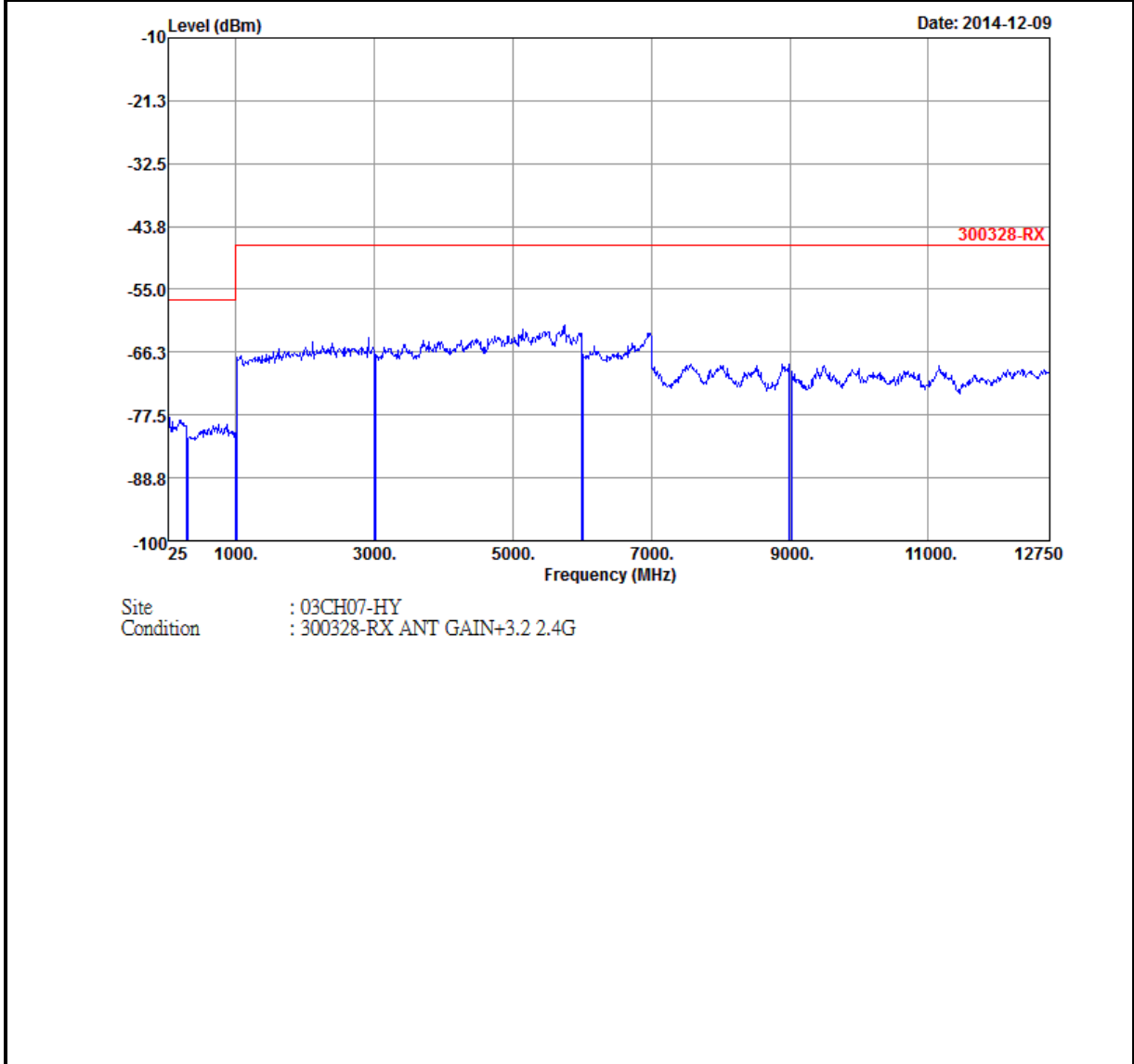

No significant emission found.



4.1.6 Test Results for Radiated Setup (Cabinet Radiation)

Test Mode :	Bluetooth (1Mbps) CH78 (2480MHz) for Ant. 1	Temperature :	23~24°C
Test Engineer :	Pony Chen	Relative Humidity :	43~44%
		Polarization :	Horizontal

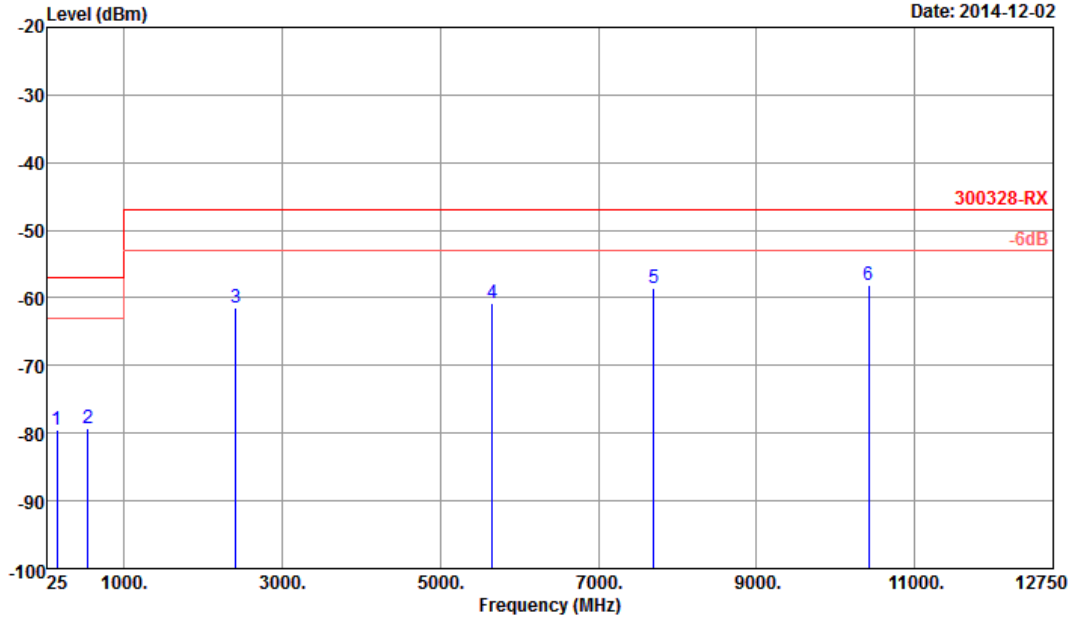

Site : 05CH03-HY
 Condition : 300328-RX HORIZONTAL
 Power : From System

	Freq	Level	Over Limit	Limit Line	Read Level	Factor	Pol/Phase
	MHz	dBm	dB	dBm	dBm	dB	
1	151.23	-79.50	-22.50	-57.00	-66.05	-13.45	HORIZONTAL
2	541.50	-79.32	-22.32	-57.00	-72.56	-6.76	HORIZONTAL
3	2418.00	-61.34	-14.34	-47.00	-53.28	-8.06	HORIZONTAL
4	5661.00	-60.73	-13.73	-47.00	-60.52	-0.21	HORIZONTAL
5	7701.00	-58.61	-11.61	-47.00	-63.37	4.76	HORIZONTAL
6 @	10413.75	-58.05	-11.05	-47.00	-65.83	7.78	HORIZONTAL



Test Mode :	Bluetooth (1Mbps) CH78 (2480MHz) for Ant. 1	Temperature :	23~24°C
Test Engineer :	Pony Chen	Relative Humidity :	43~44%
		Polarization :	Vertical

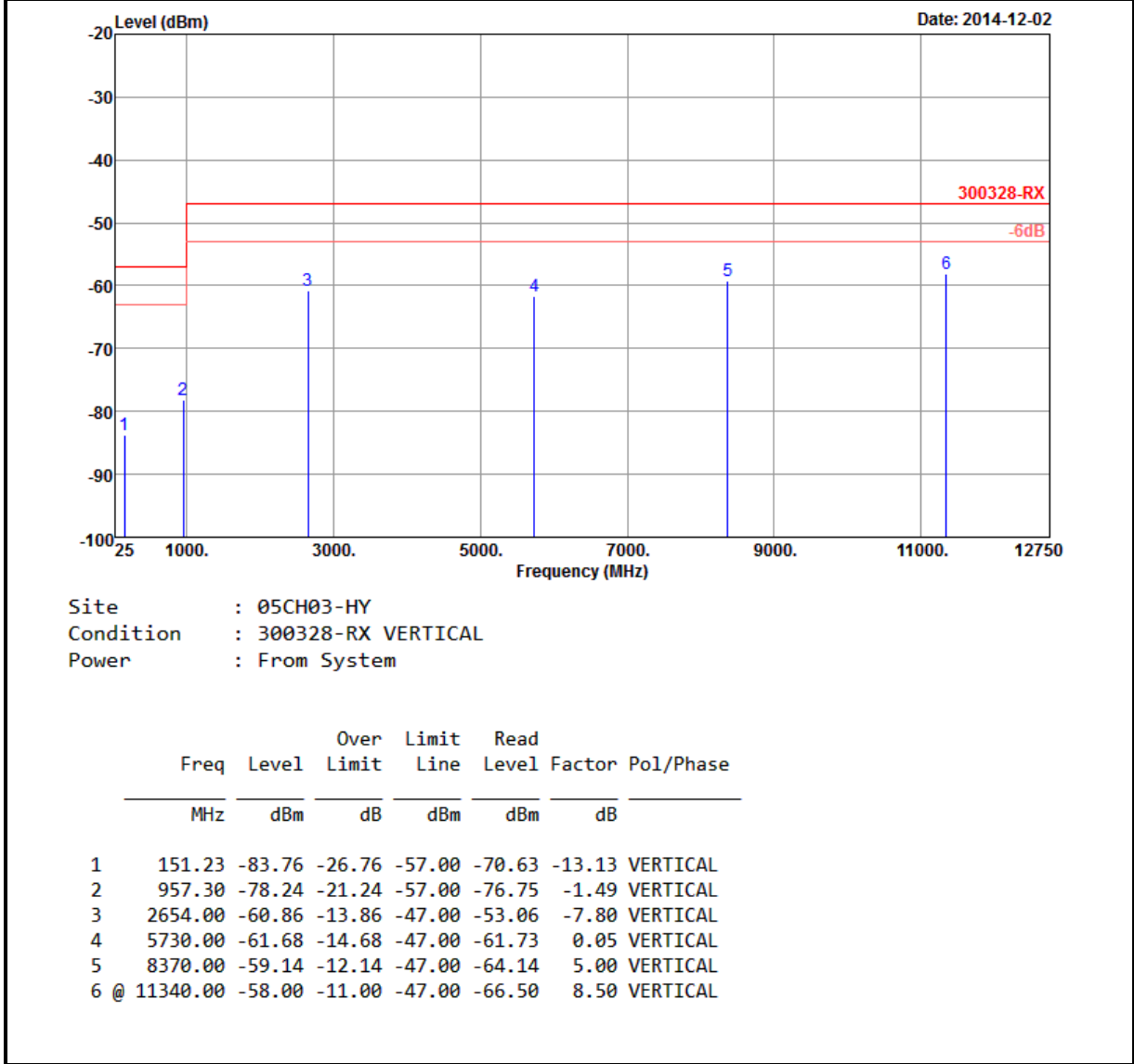

5 Adaptivity Test

5.1 Adaptivity and Receiver Blocking

5.1.1 Limit of Adaptivity and Receiver Blocking

Only for adaptive systems and RF Output Power > 10 dBm

LBT based Detect and Avoid (Load Based Equipment with spectrum sharing mechanism IEEE Std.):

LBT based spectrum sharing mechanism may implement IEEE Std. 802.11-2007 clauses 15, 17, 18 or 19, in IEEE Std. 802.11n-2009, clause 20 or in IEEE Std. 802.15.4-2006,

Short Control Signaling Transmissions shall have a maximum duty cycle of 10 % within an observation period of 50 ms.

5.1.2 Measurement Instruments

The measuring equipment is listed in the section 7 of this test report.

5.1.3 Test Procedures

1. The measurement procedure follows the clause 5.3.7.2.1 of the ETSI EN 300 328 V1.8.1 (2012-06).
2. For conducted measurements on devices with multiple transmit chains and receive chains. The power splitter/combiner shall be used to combine all the transmit/receive chains (antenna outputs) into a single test point. The insertion loss of the power splitter/combiner shall be taken into account.

5.1.4 Test Setup

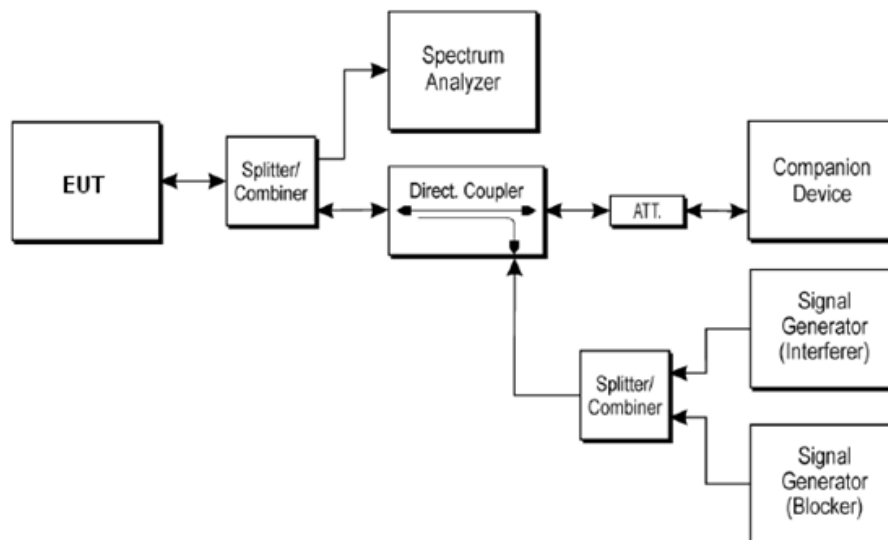



5.1.5 Support Unit used in test configuration and system

Item	Instrument	Manufacturer	Model No.	Characteristics
1.	WLAN AP	Motorola	AP7131N	Dual Band AP
2.	Notebook	Lenovo	E335	FTP / LAN

5.1.6 Test Results of Adaptivity and Receiver Blocking

Equipment Information:	
<input type="checkbox"/>	Non-Adaptive Equipment
	The maximum RF output power (E.I.R.P.) dBm:
	The maximum (Corresponding) Duty Cycle : %
<input checked="" type="checkbox"/>	Adaptive Equipment without the possibility to switch to a non-adaptive mode:
<input checked="" type="checkbox"/>	The equipment has implemented an LBT based DAA mechanism:
	<input type="checkbox"/> The equipment is Frame Based equipment
	<input type="checkbox"/> The equipment is Load Based equipment
	<input type="checkbox"/> The equipment can switch dynamically between Frame Based and Load Based equipment
<input type="checkbox"/>	The equipment has implemented an non-LBT based DAA mechanism
<input type="checkbox"/>	The equipment can operate in more than one adaptive mode
<input checked="" type="checkbox"/>	Adaptive Frequency Hopping using other forms of DAA (non-LBT based)
<input type="checkbox"/>	Adaptive Equipment which can also operate in non-adaptive mode

	Modulation	Data Rate (single)	Nominal Bandwidth	Channel	Test Frequency	Test Result
BT Nom	GFSK	1Mbit/s	1MHz	00	2402 MHz	PASS
				78	2480 MHz	PASS

Note: The CCA time is declared by the manufacturer.

5.1.7 Test Plots of Adaptivity Test

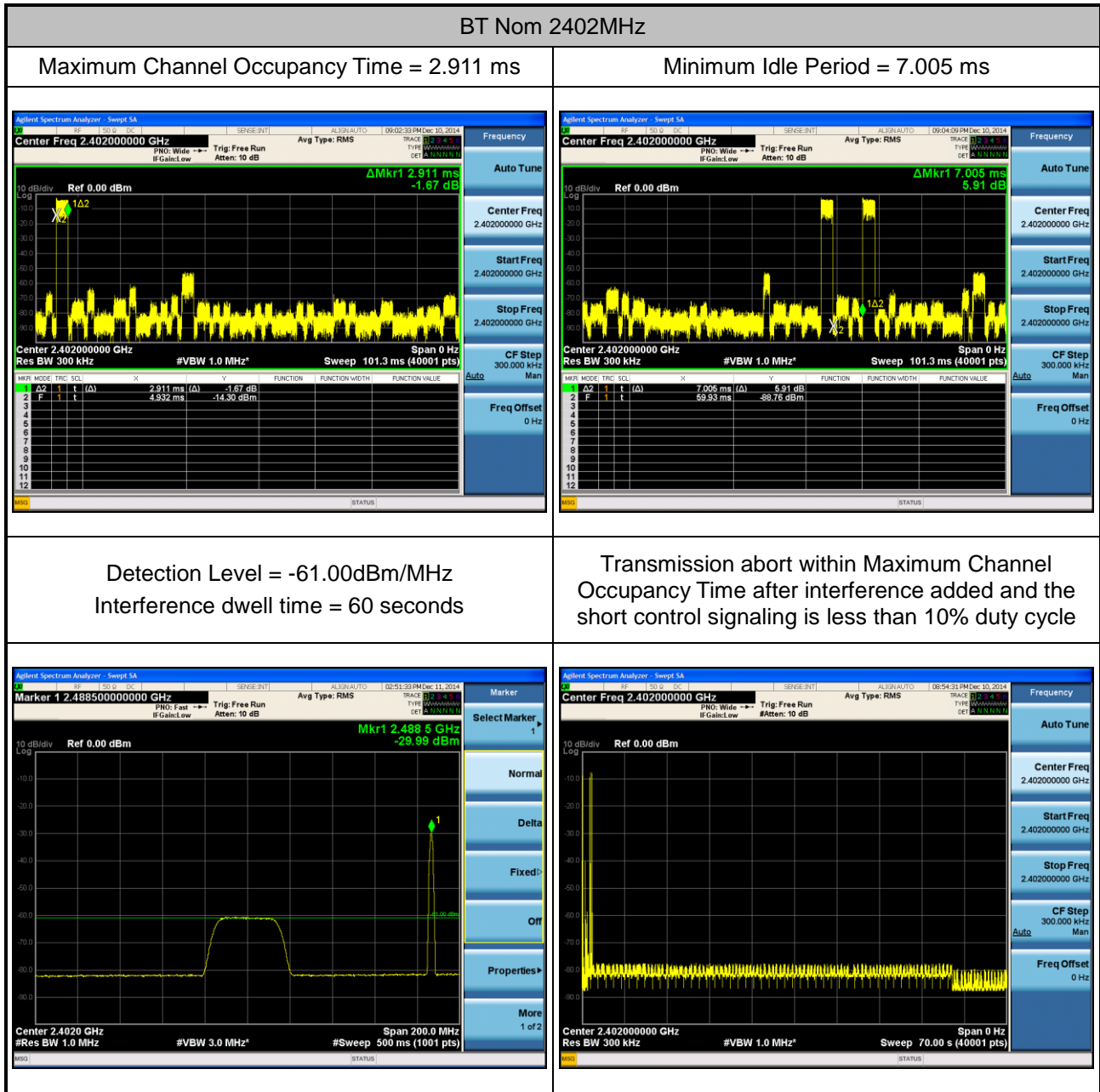

Note: Detection Level = -70 + 20 – EIRP + Gain for conducted measurement.



BT Nom 2480MHz

Maximum Channel Occupancy Time = 2.908 ms

Minimum Idle Period = 924.7 μ s

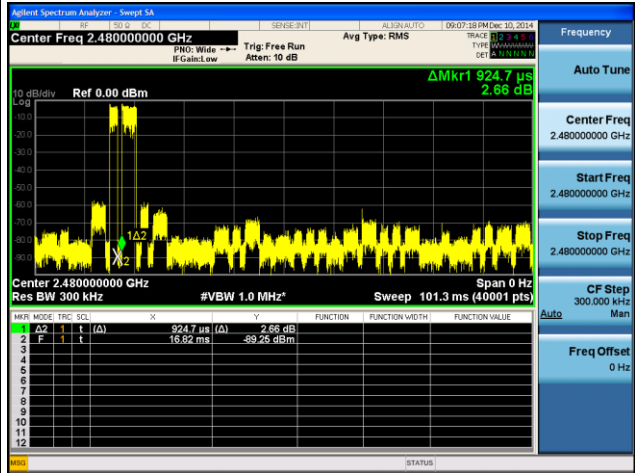
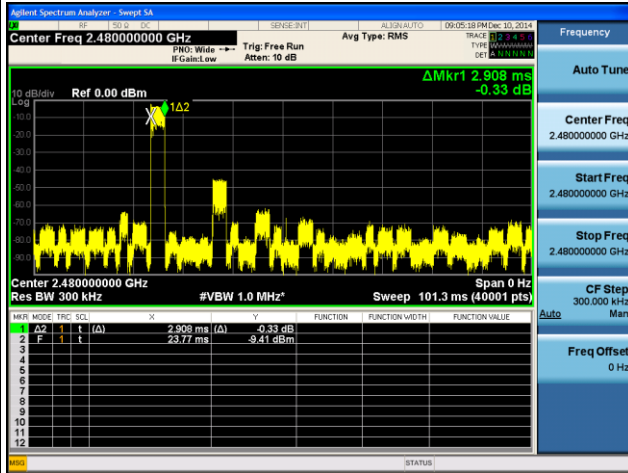

Detection Level = -61.00dBm/MHz
Interference dwell time = 60 seconds

Transmission abort within Maximum Channel Occupancy Time after interference added and the short control signaling is less than 10% duty cycle

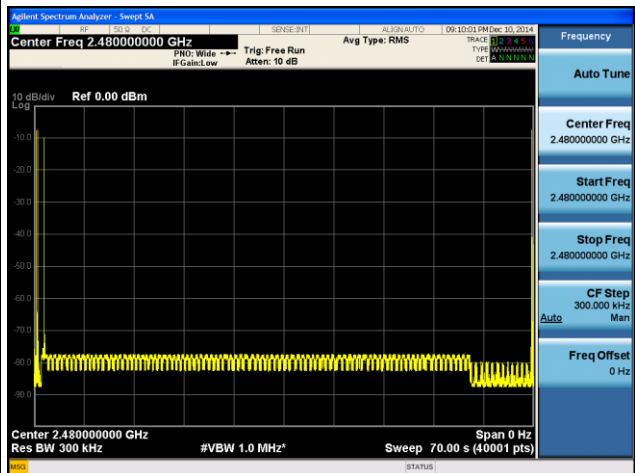
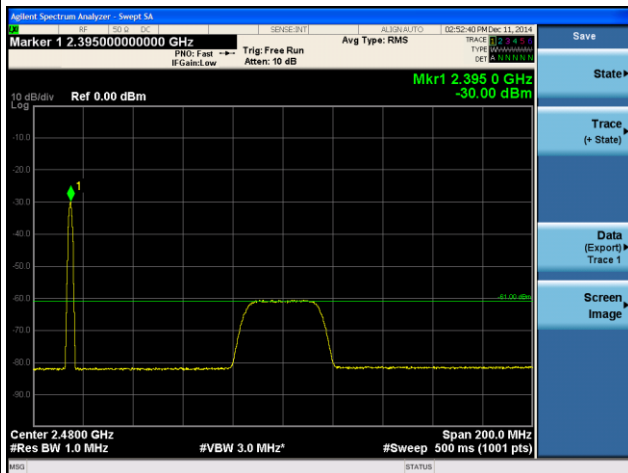

Note: Detection Level = -70 + 20 – EIRP + Gain for conducted measurement.



Zoom-in plot when the interference injected at 0 sec

BT Nom 2402MHz	BT Nom 2480MHz
<p>Detection Level = -61.00dBm/MHz Interference dwell time = 60 seconds</p>	<p>Detection Level = -61.00dBm/MHz Interference dwell time = 60 seconds</p>
<p>Aggregation Time during interference = $2.91\text{ms} \times (N=12) = 34.92\text{ ms}$ Accumulated COT is less than 40ms.</p>	<p>Aggregation Time during interference = $2.91\text{ms} \times (N=2) = 5.82\text{ms}$ Accumulated COT is less than 40ms.</p>

6 Photographs of Radiated Emission Test Configuration

LF



HF

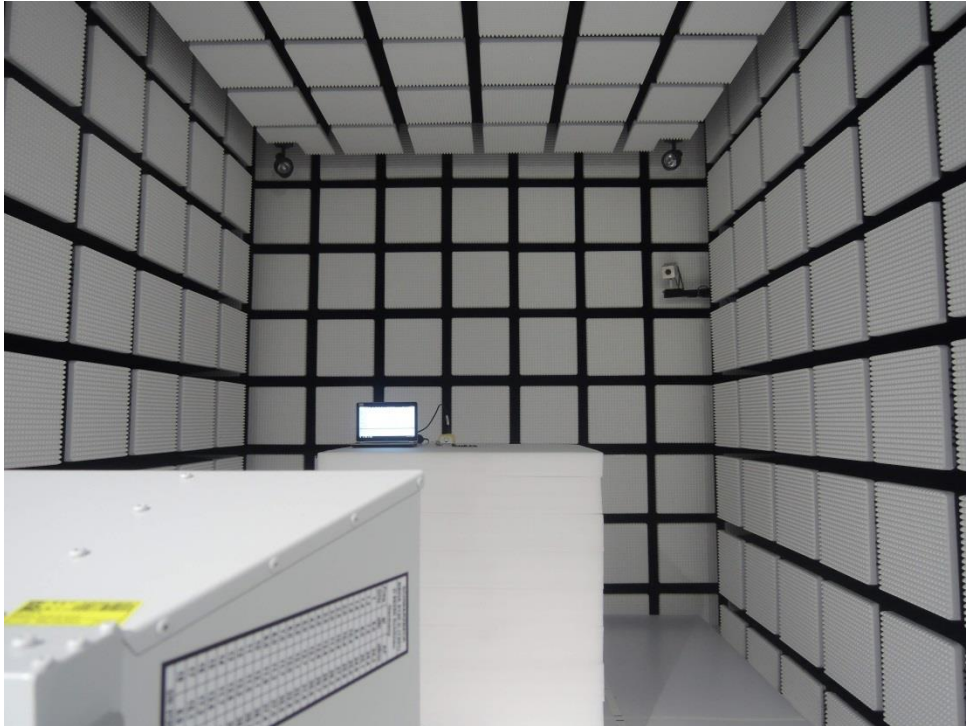



7 List of Measuring Equipment

Instrument	Manufacturer	Model No.	Serial No.	Characteristics	Calibration Date	Test Date	Due Date	Remark
Spectrum Analyzer	Rohde & Schwarz	FSP40	100055	9kHz~40GHz	Jun. 09, 2014	Nov. 27, 2014 ~ Dec. 09, 2014	Jun. 08, 2015	Conducted (TH02-HY)
Power Meter	DARE	RPR3006W	13I00030SN O31	9kHz~6GHz	Sep. 30, 2014	Nov. 27, 2014 ~ Dec. 09, 2014	Sep. 29, 2015	Conducted (TH02-HY)
Thermal Chamber	Ten Billion	TTH-D3SP	TBN-930701	N/A	Jul. 17, 2014	Nov. 27, 2014 ~ Dec. 09, 2014	Jul. 16, 2015	Conducted (TH02-HY)
Signal Analyzer	Rohde & Schwarz	FSQ	200578/026	20Hz~26.5GHz	Feb. 11, 2014	Nov. 27, 2014 ~ Dec. 09, 2014	Feb. 10, 2015	Conducted (TH02-HY)
Signal Generator (Interferer)	Rohde & Schwarz	SMJ100A	101375	9kHz~6GHz	Feb. 19, 2014	Dec. 10, 2014~ Dec. 11, 2014	Feb. 18, 2015	Conducted (TH02-HY)
Signal Generator (Blocker)	Rohde & Schwarz	SMU200A	103008	9kHz~3GHz	May 13, 2014	Dec. 10, 2014~ Dec. 11, 2014	May 12, 2015	Conducted (TH02-HY)
Spectrum Analyzer	Agilent	N9030A	MY52350276	3Hz~44GHz	Mar. 10, 2014	Dec. 10, 2014~ Dec. 11, 2014	Mar. 09, 2015	Conducted (TH02-HY)
Spectrum Analyzer	Agilent	N9010A	MY53470118	10Hz~ 44GHz	Feb. 10, 2014	Dec. 02, 2014	Feb. 09, 2015	Radiation (05CH03-HY)
Bilog Antenna	TDK	HLP-3003C	130776	30MHz ~ 3GHz	Dec. 12, 2013	Dec. 02, 2014	Dec. 11, 2014	Radiation (05CH03-HY)
Double Ridged Guide Horn Antenna	SCHWARZBECK	BBHA 9120 D	BBHA 9120 D 1212	1GHz ~ 18GHz	Mar. 03, 2014	Dec. 02, 2014	Mar. 02, 2015	Radiation (05CH03-HY)
Amplifier	EMCI	EMC001830	980191	10MHz~8GHz	Jan. 27, 2014	Dec. 02, 2014	Jan. 26, 2015	Radiation (05CH03-HY)
Preamplifier	Agilent	8449B	3008A02665	1GHz~26.5GHz	Feb. 10, 2014	Dec. 02, 2014	Feb. 09, 2015	Radiation (05CH03-HY)
Antenna Mast	ChainTek	MD-200	1308055	1m ~ 4m	N/A	Dec. 02, 2014	N/A	Radiation (05CH03-HY)
Turn Table	ChainTek	T-150S	1308010	0 degree ~ 360 degree	N/A	Dec. 02, 2014	N/A	Radiation (05CH03-HY)
Spectrum Analyzer	Rohde & Schwarz	FSV30	101749	10Hz ~ 30GHz	Feb. 10, 2014	Nov. 29, 2014 ~ Dec. 09, 2014	Feb. 09, 2015	Radiation (03CH07-HY)



8 Uncertainty Evaluation

Test Item	Uncertainty
Occupied Channel Bandwidth	$\pm 0.49 \%$
RF output power, conducted	$\pm 0.61 \text{ dB}$
Power density, conducted	$\pm 0.60 \text{ dB}$
Radiated emissions	$\pm 2.79 \text{ dB}$
Temperature	$\pm 0.8 \text{ }^\circ\text{C}$
Humidity	$\pm 3 \%$
Time	$\pm 0.33 \%$



Please refer to Sporton report number ER4O0971B as below.



CE Radio Test Report

APPLICANT : Texas Instruments Incorporated
EQUIPMENT : WiFi and Bluetooth Module
BRAND NAME : Texas Instruments
MODEL NAME : WL18MODGI
STANDARD : ETSI EN 300 328 V1.8.1 (2012-06)
TEST DATE(S) : Nov. 18, 2014 ~ Dec. 15, 2014

The measurement shown in this test report is tested in accordance with the test procedures given in EN 300 328 V1.8.1 (2012-06).

The test results in this report apply exclusively to the tested model / sample. Without written approval of SPORTON INTERNATIONAL INC., the test report shall not be reproduced except in full.

Reviewed by: Joseph Lin / Supervisor

Approved by: Jones Tsai / Manager



SPORTON INTERNATIONAL INC.

No. 52, Hwa Ya 1st Rd., Hwa Ya Technology Park, Kwei-Shan Hsiang, Tao Yuan Hsien, Taiwan, R.O.C.

SPORTON INTERNATIONAL INC.
TEL : 886-3-327-3456
FAX : 886-3-328-4978

Page Number : 1 of 57
Report Issued Date : Jan. 06, 2015
Report Version : Rev. 01

Report Template No.: BU5-ER328181 Version 1.0



TABLE OF CONTENTS

REVISION HISTORY	3
SUMMARY OF TEST RESULT	4
1 GENERAL DESCRIPTION	5
1.1 Applicant	5
1.2 Manufacturer.....	5
1.3 Product Feature of Equipment Under Test.....	5
1.4 Product Specification subjective to this standard	6
1.5 Modification of EUT	6
1.6 Testing Facility.....	7
1.7 Applied Standards	7
1.8 Test Condition.....	7
2 TEST CONFIGURATION OF EQUIPMENT UNDER TEST	8
2.1 Descriptions of Test Mode.....	8
2.2 Connection Diagram of EUT Test Configurations	9
2.3 Supported Unit used in test configuration and system	10
2.4 EUT Operation Test Setup	10
3 TRANSMITTER PARAMETERS	11
3.1 Maximum Transmit Power.....	11
3.2 Maximum Equivalent Isotropically Radiated Power (E.I.R.P.) Spectral Density	14
3.3 Occupied Channel Bandwidth	17
3.4 Transmitter unwanted emissions in the out-of-band domain	19
3.5 Transmitter spurious emissions	21
4 RECEIVER PARAMETERS	39
4.1 Receiver spurious emissions.....	39
5 ADAPTIVITY TEST	45
5.1 Adaptivity and Receiver Blocking	45
6 PHOTOGRAPHS OF RADIATED EMISSION TEST CONFIGURATION	55
7 LIST OF MEASURING EQUIPMENT	56
8 UNCERTAINTY EVALUATION	57



SUMMARY OF TEST RESULT

CLAUSE (EN 300 328)	TEST PARAMETER	PASS/FAIL	REMARK
Transmitter Parameters			
4.3.1.1 4.3.2.1	Maximum Transmit Power	PASS	-
4.3.2.2	Maximum Equivalent Isotropically Radiated Power (E.I.R.P.) Spectral Density	PASS	Only applicable for modulations other than FHSS
4.3.1.7 4.3.2.6	Occupied Channel Bandwidth	PASS	-
4.3.1.3 4.3.1.4	Frequency Hopping Requirements	Not Performed	Only applicable for FHSS
4.3.1.8 4.3.2.7	Transmitter spurious emissions in OOB	PASS	Under limit 3.80 dB
4.3.1.9 4.3.2.8	Transmitter spurious emissions	PASS	Under limit 11.77 dB at 4824.000 MHz
Receiver Parameters			
4.3.1.10 4.3.2.9	Receiver spurious emissions	PASS	Under limit 8.50 dB at 1330.000 MHz
Adaptive Test Item			
4.3.1.6 4.3.2.5	Adaptivity	PASS	Only applicable for adaptive equipment Output Power >10dBm
4.3.1.11 4.3.2.10	Receiver Blocking	PASS	
Non-Adaptive Test Item			
4.3.1.2 4.3.2.3	Duty cycle, Tx-Sequence, Tx-gap	Not Required	Only applicable for non-adaptive equipment Output Power >10dBm
4.3.1.5 4.3.2.4	Medium Utilisation (MU) factor	Not Required	
Note: WiFi belongs to adaptive equipment and EIRP > 10dBm.			



1 General Description

1.1 Applicant

Texas Instruments Incorporated
12500 TI Boulevard, M/S 8751, Dallas, TX 75243, USA

1.2 Manufacturer

Jorjin Technologies Inc
17F, No. 239, Sec. 1, Datong Rd., Xizhi Dist., New Taipei City 221, Taiwan

1.3 Product Feature of Equipment Under Test

Product Feature	
Equipment	WiFi and Bluetooth Module
Brand Name	Texas Instruments
Model Name	WL18MODGI
EUT supports Radios application	WLAN 11a/b/g/n HT20/HT40 Bluetooth v4.0 EDR/LE
HW Version	WG7837-T0B
EUT Stage	Identical Prototype

Remark:The above EUT's information was declared by manufacturer. Please refer to the specifications or user's manual for more detailed description.



1.4 Product Specification subjective to this standard

Product Specification subjective to this standard																			
Transmitter / Receiver Frequency Range	2400 MHz ~ 2483.5 MHz																		
Number of Channels	13																		
Channel Spacing	5 MHz																		
Maximum EIRP Average Power	<Ant. 1> 802.11b : 19.30 dBm 802.11g : 19.80 dBm 802.11n HT40 : 17.50 dBm SISO <Ant. 1> 802.11n HT20 : 19.10 dBm MIMO <Ant. 1+2> 802.11n HT20 : 19.90 dBm																		
Type of Modulation	802.11b : DSSS (DBPSK / DQPSK / CCK) 802.11g/n: OFDM (BPSK / QPSK / 16QAM / 64QAM)																		
Antenna Function for Transmitter	<table border="1"> <thead> <tr> <th></th> <th>Ant. 1</th> <th>Ant. 2</th> </tr> </thead> <tbody> <tr> <td>802.11 b</td> <td>V</td> <td>-</td> </tr> <tr> <td>802.11 g</td> <td>V</td> <td>-</td> </tr> <tr> <td>802.11n HT20 SISO</td> <td>V</td> <td>-</td> </tr> <tr> <td>802.11n HT20 MIMO</td> <td>V</td> <td>V</td> </tr> <tr> <td>802.11n HT40</td> <td>V</td> <td>-</td> </tr> </tbody> </table>		Ant. 1	Ant. 2	802.11 b	V	-	802.11 g	V	-	802.11n HT20 SISO	V	-	802.11n HT20 MIMO	V	V	802.11n HT40	V	-
	Ant. 1	Ant. 2																	
802.11 b	V	-																	
802.11 g	V	-																	
802.11n HT20 SISO	V	-																	
802.11n HT20 MIMO	V	V																	
802.11n HT40	V	-																	
Power Supply	Battery / AC Adapter																		

Note: For other wireless features of this EUT, test report will be issued separately.

Antenna Information			
Antenna Type	Brand	2.4GHz~2.5GHz	4.9GHz~5.8GHz
PCB	Ethertronics	-0.6	4.5
Dipole	LSR	2	2
PCB	Laird	2	4
Chip	Pulse	3.2	4.2
PIFA	LSR	2	3
Chip	TDK	2.4	3.96

1.5 Modification of EUT

No modifications are made to the EUT during all test items.

1.6 Testing Facility

Test Site	SPORTON INTERNATIONAL INC.
Test Site Location	No. 52, Hwa Ya 1 st Rd., Hwa Ya Technology Park, Kwei-Shan Hsiang, Tao Yuan Hsien, Taiwan, R.O.C. TEL: +886-3-327-3456 FAX: +886-3-328-4978
Test Site No.	Sporton Site No. : TH02-HY ; 03CH07-HY

Test Site	SPORTON INTERNATIONAL INC.
Test Site Location	No. 13-1&14-1, Lane 19, Wen 33rd St. Kwei-Shan Hsiang, Tao Yuan Hsien, Taiwan, R.O.C. TEL: +886-3-318-0787/+886-3-318-0792 FAX: +886-3-318-0287
Test Site No.	Sporton Site No. : 05CH03-HY

1.7 Applied Standards

According to the specifications of the manufacturer, the EUT must comply with the requirements of **ETSI EN 300 328 V1.8.1 (2012-06)**.

Note: All test items were verified and recorded according to the standards and without any deviation during the test.

1.8 Test Condition

Normal Voltage	DC 5V
Normal Temperature	20°C
Extreme Temperature	-40°C and 85°C

Note: The test temperature was between -40°C ~ 85°C by manufacturer requested.

2 Test Configuration of Equipment under Test

2.1 Descriptions of Test Mode

- a. Preliminary tests were performed in different data rate and recorded the RF power output in the following tables:

<Ant. 1>

2.4GHz 802.11b RF Output Power (dBm)			
Channel	CH 01	CH 07	CH 13
Frequency	2412 MHz	2442 MHz	2472 MHz
Avg. Power	16.00	15.80	16.10

2.4GHz 802.11g RF Output Power (dBm)			
Channel	CH 01	CH 07	CH 13
Frequency	2412 MHz	2442 MHz	2472 MHz
Avg. Power	12.20	16.40	16.10

2.4GHz 802.11n HT40 RF Output Power (dBm)			
Channel	CH 03	CH 07	CH 11
Frequency	2422 MHz	2442 MHz	2462 MHz
Avg. Power	9.90	14.10	13.90

SISO <Ant. 1>

2.4GHz 802.11n HT20 RF Output Power (dBm)			
Channel	CH 01	CH 07	CH 13
Frequency	2412 MHz	2442 MHz	2472 MHz
Avg. Power	12.30	15.70	15.30

MIMO <Ant. 1+2>

2.4GHz 802.11n HT20 RF Output Power (dBm)			
Channel	CH 01	CH 07	CH 13
Frequency	2412 MHz	2442 MHz	2472 MHz
Avg. Power	15.80	16.70	16.60

Note: The data rates of WLAN 802.11b/g/n were set in 1Mbps for 802.11b, 6Mbps for 802.11g, and MCS0 for HT40 for <Ant. 1>; MCS0 for 802.11n HT20 for SISO <Ant. 1>; MCS12 for 802.11n HT20 for MIMO <Ant. 1+2> due to the highest RF output power.

- b. During radiated spurious emissions testing, the interface cables and equipment positions were varied according to European Standard EN 300 328 V1.8.1 (2012-06), and the frequency range of radiation was investigated from 25 MHz to 12750 MHz.

The following tables for radiated measurement, the worst cases were recorded in this report.

Test Modes		
RF	802.11b DSSS	802.11g OFDM
Tx	802.11b CH01 (2412MHz) for Ant. 1 802.11b CH13 (2472MHz) for Ant. 1	802.11g CH01 (2412MHz) for Ant. 1 802.11g CH13 (2472MHz) for Ant. 1
Rx	802.11b CH01 (2412MHz) for Ant. 1	-

Test Modes	
RF	802.11n HT20 OFDM
Tx	802.11n HT20 CH01 (2412MHz) for SISO <Ant. 1> 802.11n HT20 CH01 (2412MHz) for MIMO <Ant. 1+2> 802.11n HT20 CH13 (2472MHz) for MIMO <Ant. 1+2>
Rx	802.11n HT20 CH01 (2412MHz) for MIMO <Ant. 1+2>

Test Modes	
RF	802.11n HT40 OFDM
Tx	802.11n HT40 CH03 (2422MHz) for Ant. 1 802.11n HT40 CH11 (2462MHz) for Ant. 1

Remark: All test modes of the Transmitter Radiated Spurious Emission (RSE) and Receiver Radiated Spurious Emission (RSE) were tested; only the test worse data in bold of these modes were reported.

2.2 Connection Diagram of EUT Test Configurations

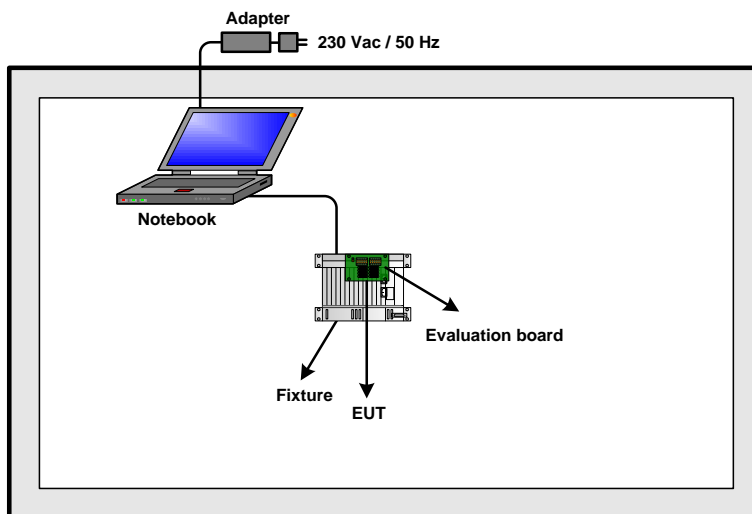



2.3 Supported Unit used in test configuration and system

Item	Equipment	Trade Name	Model Name	FCC ID	Data Cable	Power Cord
1.	Notebook	DELL	Latitude E6320	FCC DoC/ Contains FCC ID: QDS-BRCM1054	N/A	AC I/P: Unshielded, 1.2 m DC O/P: Shielded, 1.8 m
2.	Fixture	N/A	N/A	N/A	N/A	N/A
3.	Evaluation board	N/A	WG1300BE00	N/A	N/A	N/A

2.4 EUT Operation Test Setup

For WLAN function, programmed RF utility, "RTTT" installed in the notebook make the EUT provide functions like channel selection and power level for continuous transmitting and receiving signals.

3 Transmitter Parameters

3.1 Maximum Transmit Power

3.1.1 Limit of Effective Isotropic Radiated Power

SUBCLAUSE 4.3.1.1.2 and 4.3.2.1.2	
TEST CONDITION	LIMIT
Normal and Extreme Temperature Conditions	20dBm (e.i.r.p)

3.1.2 Measuring Instruments

The measuring equipment is listed in the section 7 of this test report.

3.1.3 Test Procedure

1. The measurement procedure follows the clause 5.3.2.2.1 of the ETSI EN 300 328 V1.8.1 (2012-06).
2. Placing the EUT in thermal chamber.
3. The EUT is connected to external power supply.
4. Setting thermal chamber temperature and power supply voltage at suitable values.
5. The EIRP = A+G+Y, where A is the power measured, G is the assembly gain of the individual antenna of the EUT in dBi and Y is the additional beamforming gain of the EUT in dB if applicable, here, Y=0.
6. The measurement duration is at least 1 second to ensure a minimum number of bursts (at least 10) are captured.

3.1.4 Test Setup

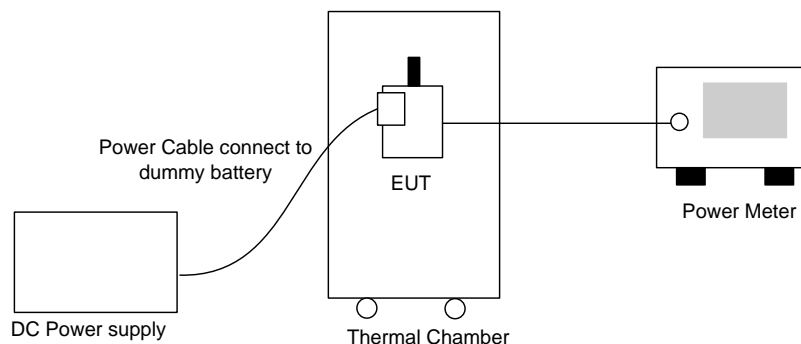



3.1.5 Test Results

Test Item :	EIRP Power	Temperature :	21~26°C
Test Engineer :	Alex Lee	Relative Humidity :	51~54%

Conducted Power (dBm)												
Mod.	Data Rate	N _{TX}	Channel	Freq. (MHz)	Temperature Nomal		Extreme Temperature Low		Extreme Temperature High		Gain (dBi)	
					20 °C		-40 °C		85 °C			
					Ant. 1	Ant. 2	Ant. 1	Ant. 2	Ant. 1	Ant. 2	Ant. 1	Ant. 2
11b	1Mbps	1	1	2412	16.00	-	15.20	-	15.50	-	3.20	3.20
11b	1Mbps	1	7	2442	15.80	-	15.30	-	15.40	-	3.20	3.20
11b	1Mbps	1	13	2472	16.10	-	16.10	-	15.20	-	3.20	3.20
11g	6Mbps	1	1	2412	12.20	-	12.60	-	10.80	-	3.20	3.20
11g	6Mbps	1	7	2442	16.40	-	16.60	-	15.30	-	3.20	3.20
11g	6Mbps	1	13	2472	16.10	-	16.30	-	15.10	-	3.20	3.20
HT20	MCS0	1	1	2412	12.30	-	12.50	-	10.90	-	3.20	3.20
HT20	MCS0	1	7	2442	15.70	-	15.90	-	14.50	-	3.20	3.20
HT20	MCS0	1	13	2472	15.30	-	15.50	-	14.30	-	3.20	3.20
HT40	MCS0	1	3	2422	9.90	-	10.20	-	8.70	-	3.20	3.20
HT40	MCS0	1	7	2442	14.10	-	14.30	-	13.00	-	3.20	3.20
HT40	MCS0	1	11	2462	13.90	-	14.10	-	12.90	-	3.20	3.20
HT20	MCS0	2	1	2412	15.80		15.80		15.00		3.20	
HT20	MCS0	2	7	2442	16.70		16.70		15.80		3.20	
HT20	MCS0	2	13	2472	16.60		16.60		15.60		3.20	



EIRP Power (dBm)												
Mod.	Data Rate	N _{TX}	Channel	Freq. (MHz)	Temperature Nomal		Temperature Low		Temperature High		Limit (dBm)	Pass/Fail
					20 °C		-40 °C		85 °C			
					Ant. 1	Ant. 2	Ant. 1	Ant. 2	Ant. 1	Ant. 2		
11b	1Mbps	1	1	2412	19.20	-	18.40	-	18.70	-	20	Pass
11b	1Mbps	1	7	2442	19.00	-	18.50	-	18.60	-	20	Pass
11b	1Mbps	1	13	2472	19.30	-	19.30	-	18.40	-	20	Pass
11g	6Mbps	1	1	2412	15.40	-	15.80	-	14.00	-	20	Pass
11g	6Mbps	1	7	2442	19.60	-	19.80	-	18.50	-	20	Pass
11g	6Mbps	1	13	2472	19.30	-	19.50	-	18.30	-	20	Pass
HT20	MCS0	1	1	2412	15.50	-	15.70	-	14.10	-	20	Pass
HT20	MCS0	1	7	2442	18.90	-	19.10	-	17.70	-	20	Pass
HT20	MCS0	1	13	2472	18.50	-	18.70	-	17.50	-	20	Pass
HT40	MCS0	1	3	2422	13.10	-	13.40	-	11.90	-	20	Pass
HT40	MCS0	1	7	2442	17.30	-	17.50	-	16.20	-	20	Pass
HT40	MCS0	1	11	2462	17.10	-	17.30	-	16.10	-	20	Pass
HT20	MCS0	2	1	2412	19.00		19.00		18.20		20	Pass
HT20	MCS0	2	7	2442	19.90		19.90		19.00		20	Pass
HT20	MCS0	2	13	2472	19.80		19.80		18.80		20	Pass

Note: EIRP = measured average conducted power (burst) + antenna gain.

3.2 Maximum Equivalent Isotropically Radiated Power (E.I.R.P.) Spectral Density

3.2.1 Limit of Maximum Power Spectral Density

SUBCLAUSE 4.3.2.2.2	
TEST CONDITION	LIMIT
Normal and Extreme Temperature Conditions	10dBm / MHz

Remark: Maximum spectral power density is not applicable to FHSS system device.

3.2.2 Measuring Instruments

The measuring equipment is listed in the section 7 of this test report.

3.2.3 Test Procedure

1. The measurement procedure follows the clause 5.3.3.2.1 of the ETSI EN 300 328 V1.8.1 (2012-06).
2. These measurements shall only be performed at normal test conditions.
3. The measurement shall be repeated for the equipment being configured to operate at the lowest, the middle, and the highest frequency of the stated frequency range.
4. The test procedure shall be as follows:

Step 1:

Connect the EUT to the spectrum analyzer and use the following settings:

Start Frequency	2400MHz
Stop Frequency	2483.5MHz
Resolution BW	10kHz
Video BW	30kHz
Sweep Points	8350
Detector	RMS
Trace Mode	Max Hold
Sweep time	Auto

Step 2:

Add up the values for amplitude (power) for all the samples in the file.

Step 3:

Normalize the individual values for amplitude so that the sum is equal to the RF Output Power (e.i.r.p.) measured.

Step 4:

Starting from the first sample in the file (lowest frequency), add up the power of the following samples representing a 1 MHz segment and record the results for power and position (i.e. sample #1 to #100). This is the Power Spectral Density (e.i.r.p.) for the first 1 MHz segment which shall be recorded.

Step 5:

Shift the start point of the samples added up in step 4 by 1 sample and repeat the procedure in step 4 (i.e. sample #2 to #101).

Step 6:

Repeat step 5 until the end of the data set and record the radiated Power Spectral Density values for each of the 1 MHz segments.

From all the recorded results, the highest value is the maximum Power Spectral Density for the EUT.

This value shall be recorded in the test report.

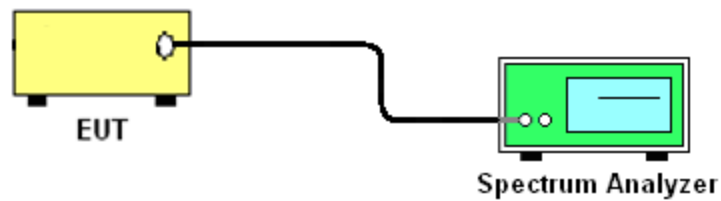
3.2.4 Test Setup



3.2.5 Test Results

Test Item :	EIRP Power Density	Temperature :	21~26°C
Test Engineer :	Alex Lee	Relative Humidity :	51~54%

Power Density												
Mod.	Data Rate	N _{TX}	Channel	Freq. (MHz)	Conducted Power Density (dBm/MHz)		Ant Gain (dBi)		EIRP Power Density (dBm/MHz)		Limit (dBm)	Pass/Fail
					Ant. 1	Ant. 2	Ant. 1	Ant. 2	Ant. 1	Ant. 2		
11b	1Mbps	1	1	2412	6.22	-	3.20	3.20	9.42	-	10	Pass
11b	1Mbps	1	7	2442	6.09	-	3.20	3.20	9.29	-	10	Pass
11b	1Mbps	1	13	2472	6.70	-	3.20	3.20	9.90	-	10	Pass
11g	6Mbps	1	1	2412	1.85	-	3.20	3.20	5.05	-	10	Pass
11g	6Mbps	1	7	2442	5.88	-	3.20	3.20	9.08	-	10	Pass
11g	6Mbps	1	13	2472	5.30	-	3.20	3.20	8.50	-	10	Pass
HT20	MCS0	1	1	2412	1.85	-	3.20	3.20	5.05	-	10	Pass
HT20	MCS0	1	7	2442	5.07	-	3.20	3.20	8.27	-	10	Pass
HT20	MCS0	1	13	2472	4.55	-	3.20	3.20	7.75	-	10	Pass
HT40	MCS0	1	3	2422	-3.40	-	3.20	3.20	-0.20	-	10	Pass
HT40	MCS0	1	7	2442	0.98	-	3.20	3.20	4.18	-	10	Pass
HT40	MCS0	1	11	2462	0.59	-	3.20	3.20	3.79	-	10	Pass
HT20	MCS0	2	1	2412	5.85		3.20		9.05		10	Pass
HT20	MCS0	2	7	2442	5.93		3.20		9.13		10	Pass
HT20	MCS0	2	13	2472	5.98		3.20		9.18		10	Pass

3.3 Occupied Channel Bandwidth

3.3.1 Limit of Occupied Channel Bandwidth

Occupied Channel Bandwidth fall completely within 2.4 GHz – 2.4835 GHz

3.3.2 Measuring Instruments

The measuring equipment is listed in the section 7 of this test report.

3.3.3 Test Procedure

1. The measurement procedure follows the clause 5.3.8.2.1 of the ETSI EN 300 328 V1.8.1 (2012-06).
2. The measurement shall be performed only on the lowest and the highest frequency within the stated frequency range.
3. The test procedure shall be as follows:

Step 1:

Connect the EUT to the spectrum analyzer and use the following settings:

Center Frequency	Channel under test
Resolution BW	1 % of the span
Video BW	3 × RBW
Frequency Span	2 × Occupied Channel Bandwidth (e.g. 40 MHz for a 20 MHz channel)
Detector	RMS
Trace Mode	Max Hold

Step 2:

Wait until the trace is completed.

Find the peak value of the trace and place the analyzer marker on this peak.

Step 3:

Use the 99 % bandwidth function of the spectrum analyzer to measure the Occupied Channel Bandwidth of the EUT.

3.3.4 Test Setup

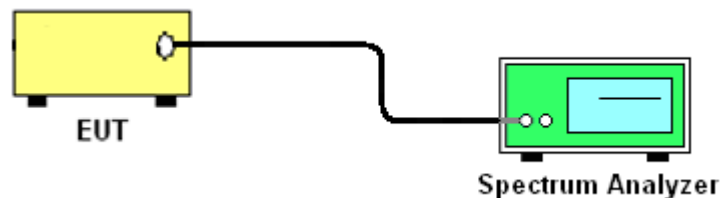



3.3.5 Test Results

Test Item :	99% Occupied BW	Temperature :	21~26°C
Test Engineer :	Alex Lee	Relative Humidity :	51~54%

Occupied Bandwidth												
Mod.	Data Rate	N _{TX}	Ch.	Freq. (MHz)	99% Occupied BW (MHz)		Freq. Low (MHz)		Freq. High (MHz)		Limit (Within operating Band)	Pass/Fail
					Ant. 1	Ant. 2	Ant. 1	Ant. 2	Ant. 1	Ant. 2		
11b	1Mbps	1	1	2412	14.76	-	2404.64	-	2419.40	-	-	Pass
11b	1Mbps	1	13	2472	14.76	-	2464.64	-	2479.40	-	-	Pass
11g	6Mbps	1	1	2412	17.00	-	2403.52	-	2420.52	-	-	Pass
11g	6Mbps	1	13	2472	20.40	-	2461.68	-	2482.08	-	-	Pass
HT20	MCS0	1	1	2412	18.04	-	2403.00	-	2421.04	-	-	Pass
HT20	MCS0	1	13	2472	19.44	-	2462.24	-	2481.68	-	-	Pass
HT40	MCS0	1	3	2422	35.92	-	2404.08	-	2440.00	-	-	Pass
HT40	MCS0	1	11	2462	36.64	-	2443.68	-	2480.32	-	-	Pass
HT20	MCS0	2	1	2412	18.12		2402.96		2421.08		-	Pass
HT20	MCS0	2	13	2472	18.44		2462.80		2481.24		-	Pass

3.4 Transmitter unwanted emissions in the out-of-band domain

3.4.1 Transmitter unwanted emissions in the out-of-band domain limit

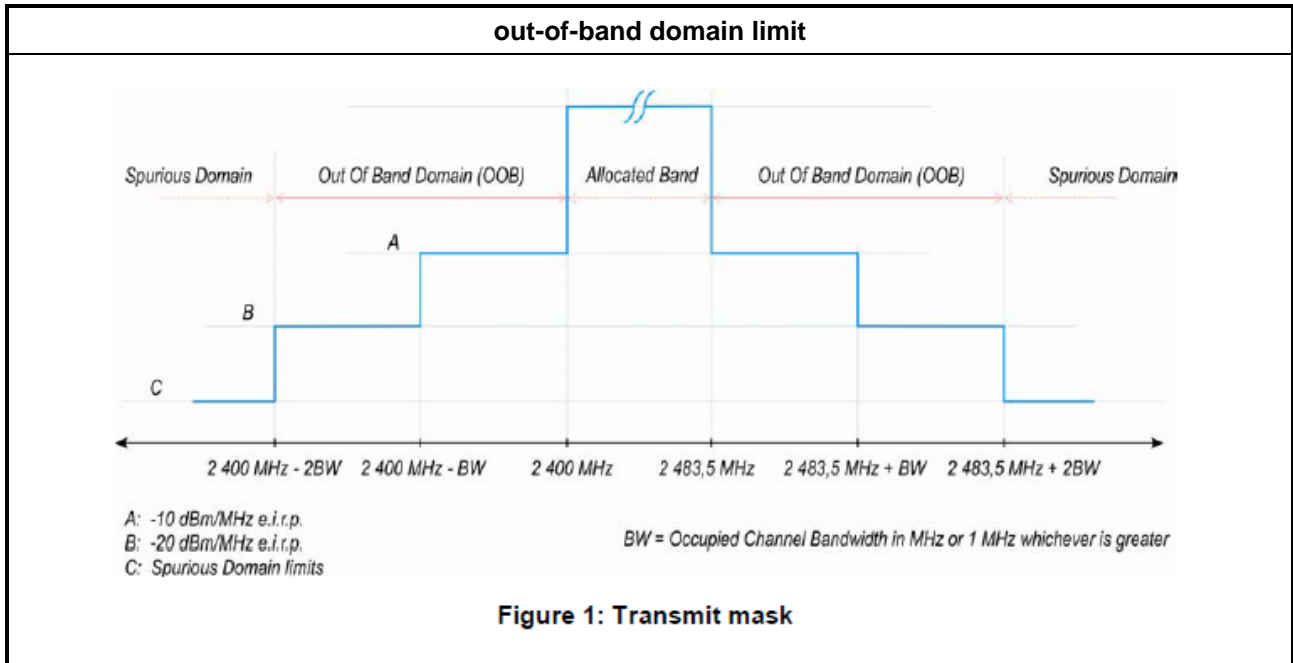

3.4.2 Measuring Instruments

The measuring equipment is listed in the section 7 of this test report.

3.4.3 Test Procedures

1. The measurement procedure follows the clause 5.3.9.2.1 of the ETSI EN 300 328 V1.8.1 (2012-06).
2. The measurements shall be performed at both normal environmental conditions and at the extremes of the operating temperature range.
3. For conducted measurements on devices with multiple transmit chains using the results for each of the transmit chains for the corresponding 1 MHz segments shall be added and compared with the transmit mask limit.

3.4.4 Test Setup

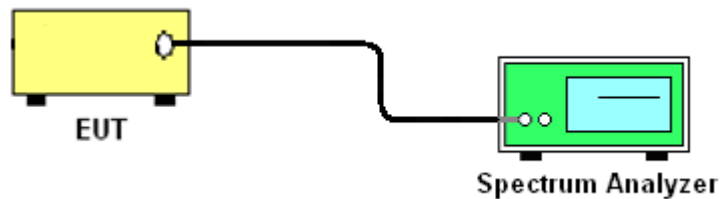



3.4.5 Test Results

Test Item :	OOB Emissions	Temperature :	21~26°C
Test Engineer :	Alex Lee	Relative Humidity :	51~54%

Mod.	Data Rate	N _{TX}	Channel	Freq. (MHz)	Temperature Nomal		Extreme Temperature Low		Extreme Temperature High		Limit (dBm/MHz)	Pass/Fail
					T nom		T min		T max			
					20 °C		-40 °C		85 °C			
					Ant. 1	Ant. 2	Ant. 1	Ant. 2	Ant. 1	Ant. 2		
11b	1Mbps	1	1	2412	-37.02	-	-35.86	-	-34.39	-	-10,-20	Pass
11b	1Mbps	1	13	2472	-34.43	-	-34.08	-	-33.96	-	-10,-20	Pass
11g	6Mbps	1	1	2412	-28.61	-	-28.61	-	-30.02	-	-10,-20	Pass
11g	6Mbps	1	13	2472	-13.80	-	-14.77	-	-14.65	-	-10,-20	Pass
HT20	MCS0	1	1	2412	-27.04	-	-29.32	-	-30.93	-	-10,-20	Pass
HT20	MCS0	1	13	2472	-15.19	-	-15.95	-	-16.44	-	-10,-20	Pass
HT40	MCS0	1	3	2422	-29.69	-	-32.44	-	-35.18	-	-10,-20	Pass
HT40	MCS0	1	11	2462	-21.52	-	-22.99	-	-22.97	-	-10,-20	Pass
HT20	MCS0	2	1	2412	-24.71		-24.82		-27.96		-10,-20	Pass
HT20	MCS0	2	13	2472	-16.90		-16.12		-18.07		-10,-20	Pass

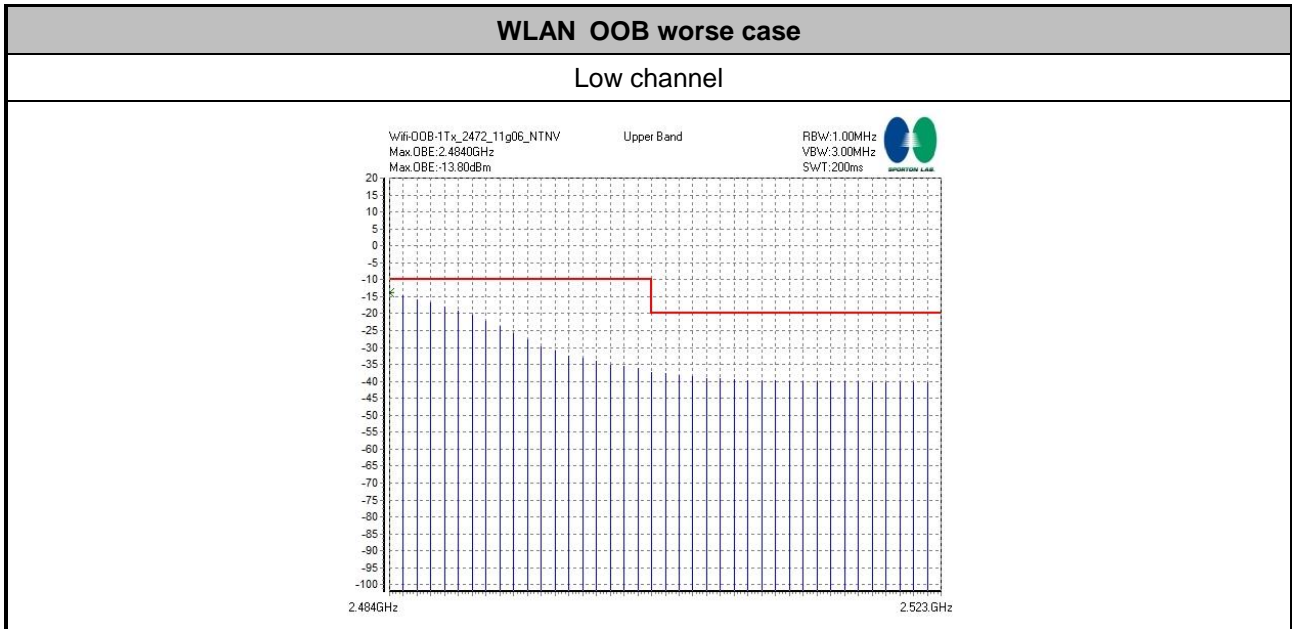

Note: Normal and extreme condition can refer to the section 1.7 of this test report.

3.5 Transmitter spurious emissions

3.5.1 Limit of Transmitter spurious emissions

Spurious emission limits for transmitter:

SUBCLAUSE 4.3.1.9.2 and 4.3.2.8.2		
FREQUENCY RANGE	MAXIMUM POWER E.R.P. (≤ 1 GHZ) E.I.R.P. (> 1 GHZ)	BANDWIDTH
30 MHz to 47 MHz	-36 dBm	100 kHz
47 MHz to 74 MHz	-54 dBm	100 kHz
74 MHz to 87,5 MHz	-36 dBm	100 kHz
87,5 MHz to 118 MHz	-54 dBm	100 kHz
118 MHz to 174 MHz	-36 dBm	100 kHz
174 MHz to 230 MHz	-54 dBm	100 kHz
230 MHz to 470 MHz	-36 dBm	100 kHz
470 MHz to 862 MHz	-54 dBm	100 kHz
862 MHz to 1 GHz	-36 dBm	100 kHz
1 GHz to 12,75 GHz	-30 dBm	1 MHz

3.5.2 Measuring Instruments

The measuring equipment is listed in the section 7 of this test report.

3.5.3 Test Procedures

1. The measurement procedure follows the clause 5.3.10.2.2 of the ETSI EN 300 328 V1.8.1 (2012-06).
2. The EUT was placed on a turntable with 1.5m height.
3. The test distance between the receiving antenna and the EUT is 3meter below 1GHz frequency range, and 3 meter which is in far field test condition for measured frequency above 1GHz, while the receiving (test) antenna is kept at 1.5 meter height.
4. Set EUT in continuous transmitting with maximum output power.
5. The table was rotated from 0 to 360 degree to search the highest radiated emission.
6. Repeating step 3 and 4 for each polarization and channel to find the worst emission level.
7. The results obtained are compared to the limits in order to prove compliance with the requirement.

3.5.4 Test Setup

<Conducted Setup>



Radiated Test Setup:

<Below 1GHz>

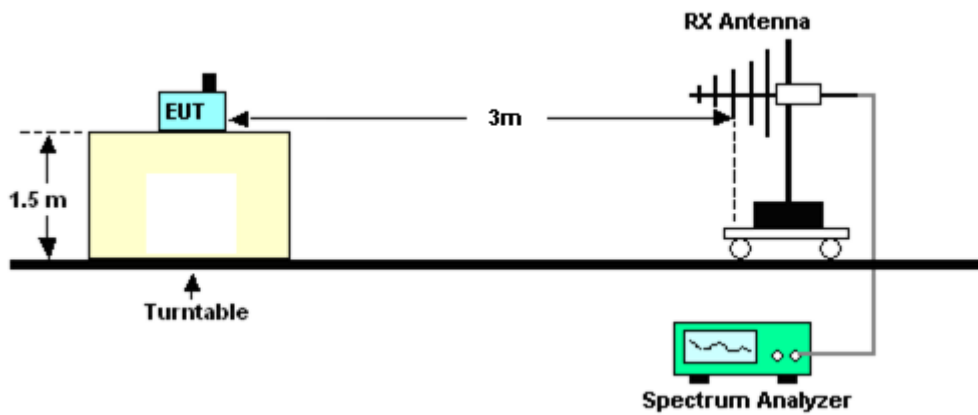

<Above 1GHz>

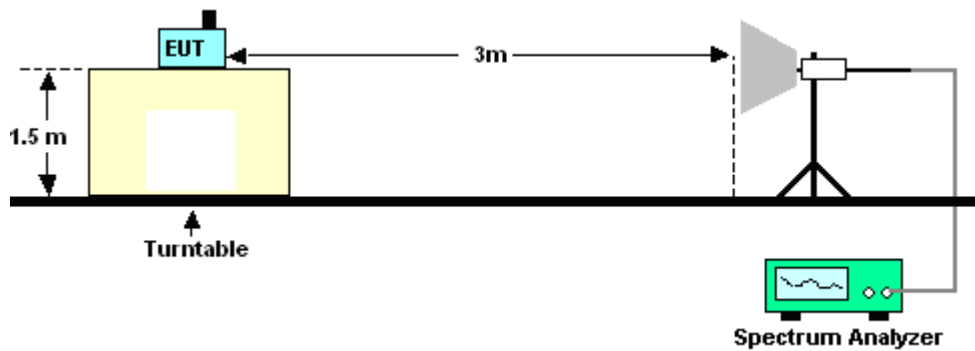



3.5.5 Test Results for Conducted Setup

Number of TX = 1, Ant. 1 (Measured)

Test Mode :	802.11b CH13 (2472MHz) for Ant. 1	Temperature :	24~26°C
Test Engineer :	Eric Shih	Relative Humidity :	42~44%

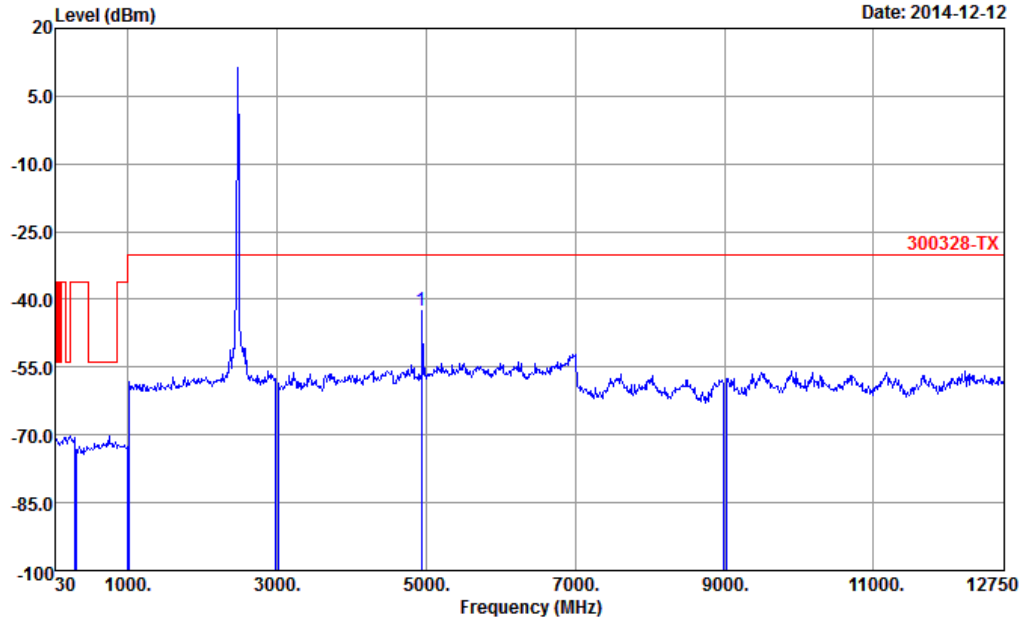

Site : 03CH07-HY
 Condition : 300328-TX ANT GAIN+3.2 2.4G

	Freq	Level	Over	Limit	ReadAntenna	Cable	Aux	Aux2	Remark
	MHz	dBm	Limit	Line	Level	Loss	Factor	Factor	
			dB	dBm	dBm	dB	dB	dB	
1	4944.00	-42.35	-12.35	-30.00	-48.05	3.20	2.50	0.00	0.00 RMS



Test Mode :	802.11g CH13 (2472MHz) for Ant. 1	Temperature :	24~26°C
Test Engineer :	Eric Shih	Relative Humidity :	42~44%

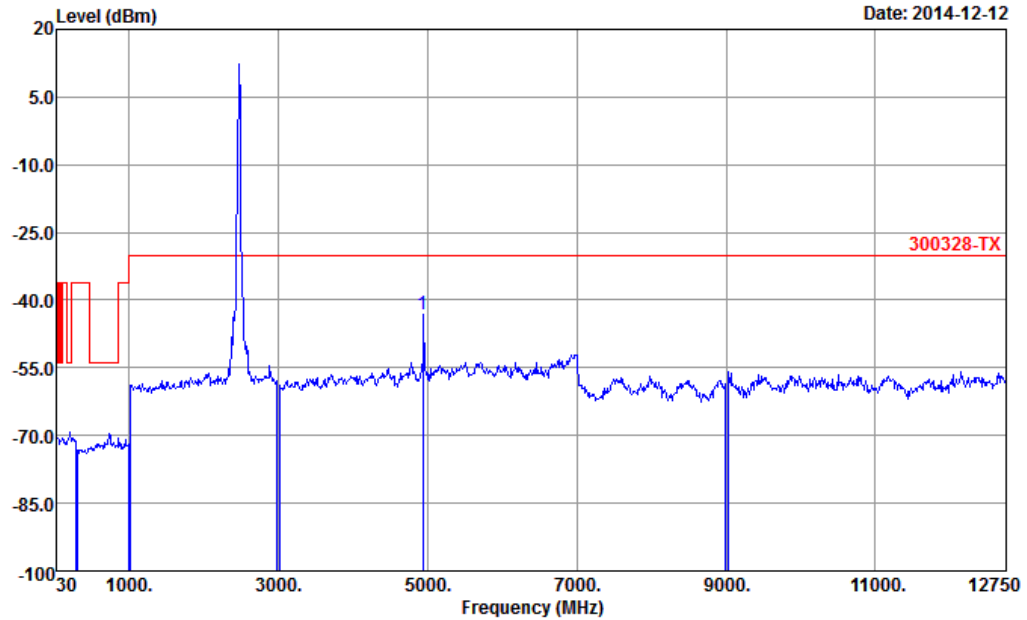

Site : 03CH07-HY
 Condition : 300328-TX ANT GAIN+3.2 2.4G

	Freq	Level	Over	Limit	ReadAntenna	Cable	Aux	Aux2	Remark
	MHz	dBm	dB	dBm	dBm	dB	dB	dB	
1	4944.00	-43.08	-13.08	-30.00	-48.78	3.20	2.50	0.00	0.00 RMS



Test Mode :	802.11n HT20 CH13 (2472MHz) for SISO <Ant. 1>	Temperature :	24~26°C
Test Engineer :	Eric Shih	Relative Humidity :	42~44%

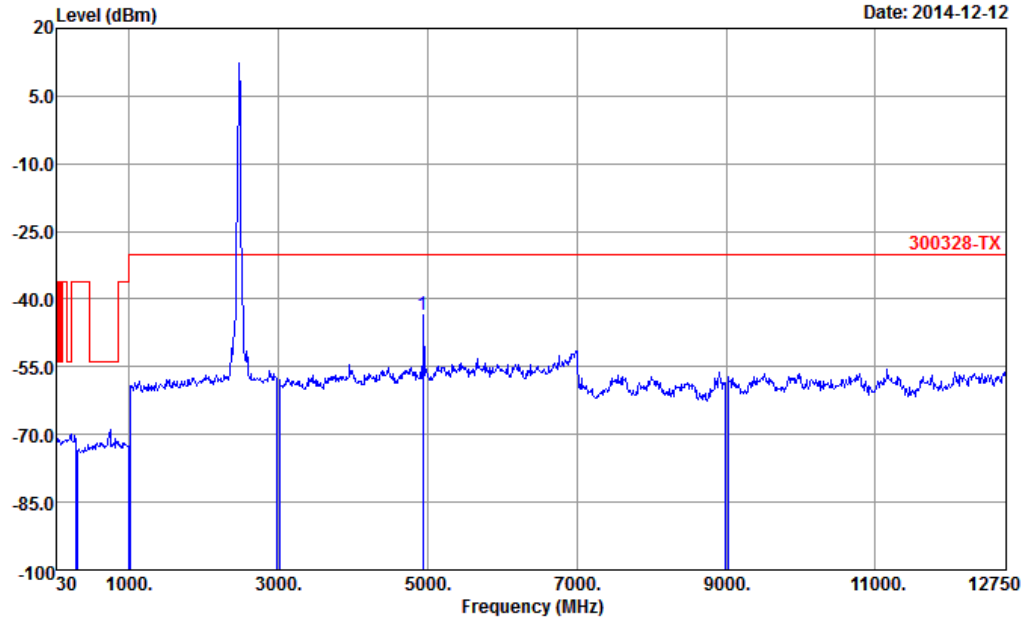

Site : 03CH07-HY
 Condition : 300328-TX ANT GAIN+3.2 2.4G

	Freq	Level	Over	Limit	Read	Antenna	Cable	Aux	Aux2	Remark
	MHz	dBm	dB	dBm	Level	Factor	Loss	Factor	Factor	
1	4944.00	-43.45	-13.45	-30.00	-49.15	3.20	2.50	0.00	0.00	RMS



Test Mode :	802.11n HT40 CH11 (2462MHz) for Ant. 1	Temperature :	24~26°C
Test Engineer :	Eric Shih	Relative Humidity :	42~44%

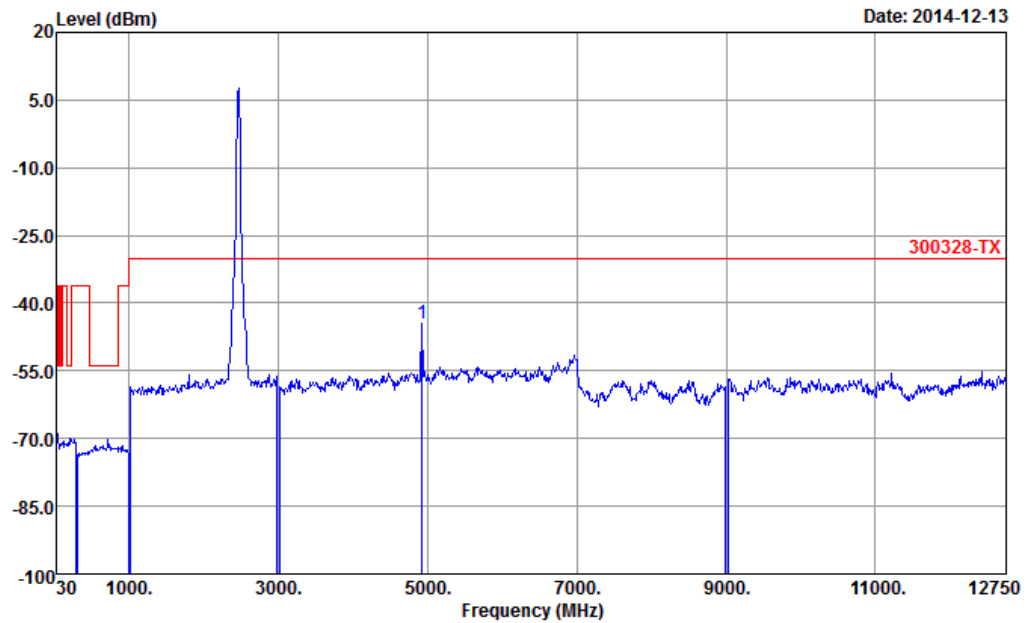

Site : 03CH07-HY
 Condition : 300328-TX ANT GAIN+3.2 2.4G

	Freq	Level	Over	Limit	Read	Antenna	Cable	Aux	Aux2	Remark
	MHz	dBm	dB	dBm	dBm	dB	dB	dB	dB	
1	4926.00	-44.41	-14.41	-30.00	-50.11	3.20	2.50	0.00	0.00	RMS



Number of TX = 2, Ant. 1 (Measured)

Test Mode :	802.11n HT20 CH01 (2412MHz) for MIMO <Ant. 1+2(1)>	Temperature :	24~26°C
Test Engineer :	Eric Shih	Relative Humidity :	42~44%

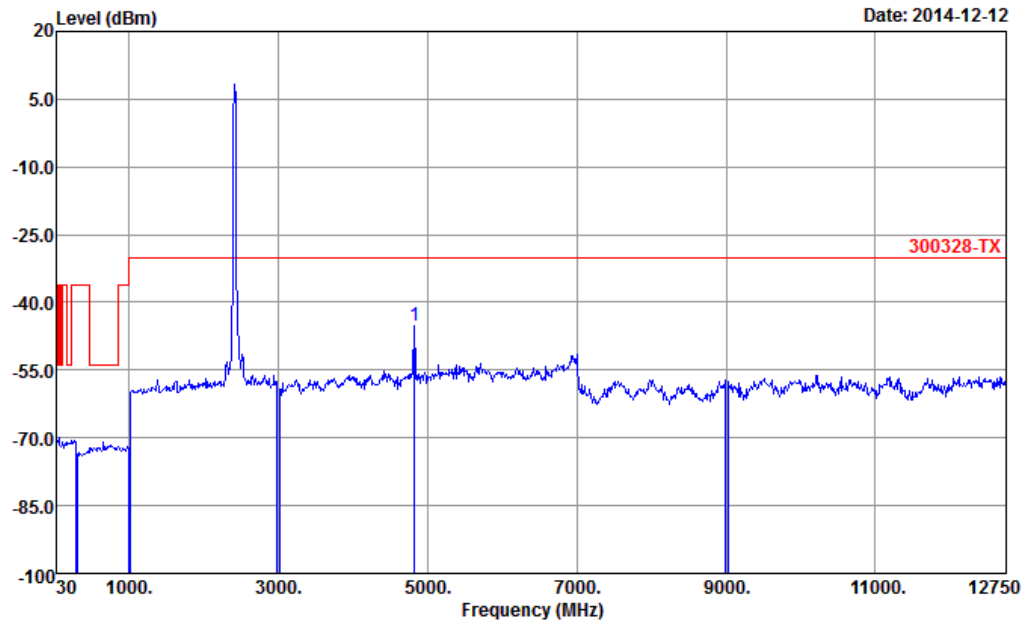

Site : 03CH07-HY
 Condition : 300328-TX ANT GAIN+3.2 2.4G

	Freq	Level	Over	Limit	ReadAntenna	Cable	Aux	Aux2	Remark
	MHz	dBm	dB	dBm	dBm	dB	dB	dB	
1	4824.00	-45.09	-15.09	-30.00	-50.79	3.20	2.50	0.00	0.00 RMS



Test Mode :	802.11n HT20 CH13 (2472MHz) for MIMO <Ant. 1+2(1)>	Temperature :	24~26°C
Test Engineer :	Eric Shih	Relative Humidity :	42~44%

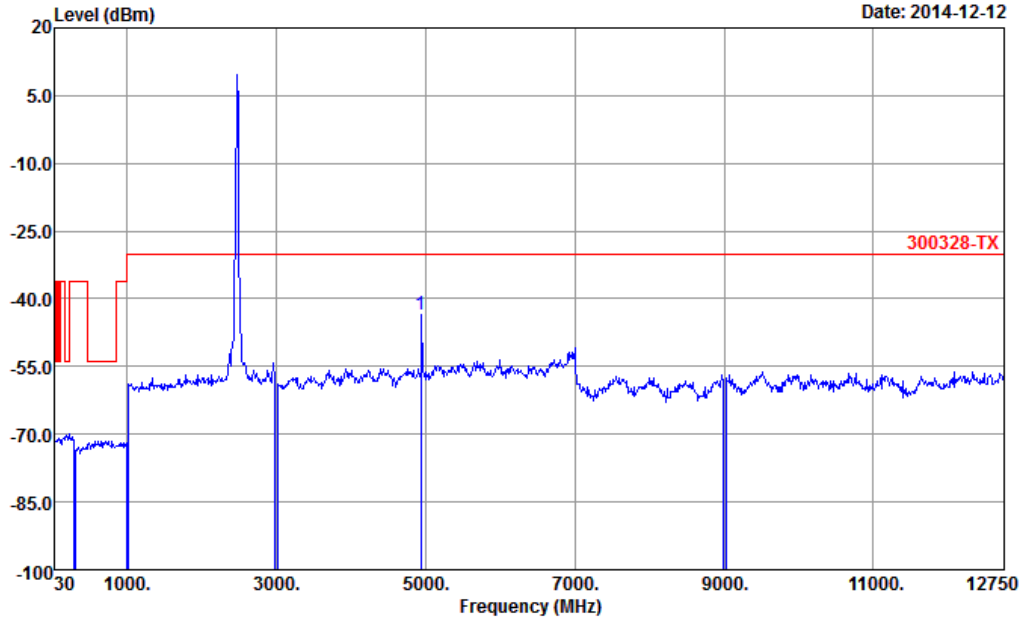

Site : 03CH07-HY
 Condition : 300328-TX ANT GAIN+3.2 2.4G

Freq	Level	Over Limit	Limit Line	ReadAntenna Level	Antenna Factor	Cable Loss	Aux Factor	Aux2 Factor	Remark
MHz	dBm	dB	dBm	dBm	dB	dB	dB	dB	
1 4944.00	-43.57	-13.57	-30.00	-49.27	3.20	2.50	0.00	0.00	RMS



Number of TX = 2, Ant. 2 (Measured)

Test Mode :	802.11n HT20 CH01 (2412MHz) for MIMO <Ant. 1+2(2)>	Temperature :	24~26°C
Test Engineer :	Eric Shih	Relative Humidity :	42~44%

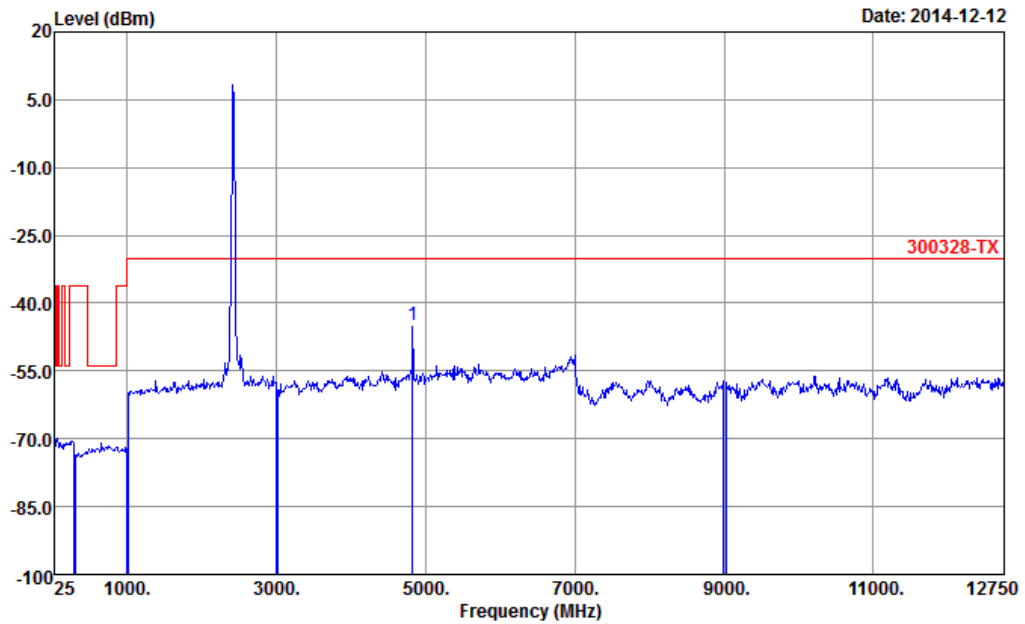

Site : 03CH07-HY
 Condition : 300328-TX ANT GAIN+3.2 2.4G

	Freq	Level	Over	Limit	ReadAntenna	Cable	Aux	Aux2	Remark
	MHz	dBm	dB	dBm	dBm	dB	dB	dB	
1	4824.00	-44.71	-14.71	-30.00	-50.41	3.20	2.50	0.00	0.00 RMS



Test Mode :	802.11n HT20 CH13 (2472MHz) for MIMO <Ant. 1+2(2)>	Temperature :	24~26°C
Test Engineer :	Eric Shih	Relative Humidity :	42~44%

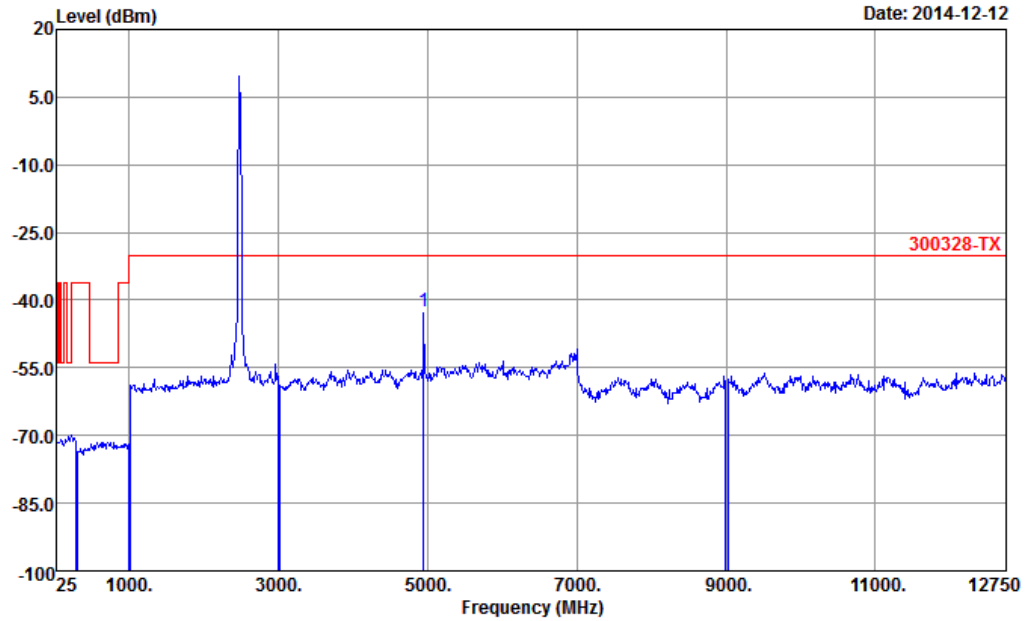

Site : 03CH07-HY
 Condition : 300328-TX ANT GAIN+3.2 2.4G

	Freq	Level	Over	Limit	ReadAntenna	Cable	Aux	Aux2	Remark
	MHz	dBm	dB	dBm	dBm	dB	dB	dB	
1	4944.00	-42.49	-12.49	-30.00	-48.19	3.20	2.50	0.00	0.00 RMS



3.5.6 Test Results for Radiated Setup (Cabinet Radiation)

Test Mode :	802.11b CH01 (2412MHz) for Ant. 1	Temperature :	23~24°C
Test Engineer :	Pony Chen	Relative Humidity :	43~44%
		Polarization :	Horizontal

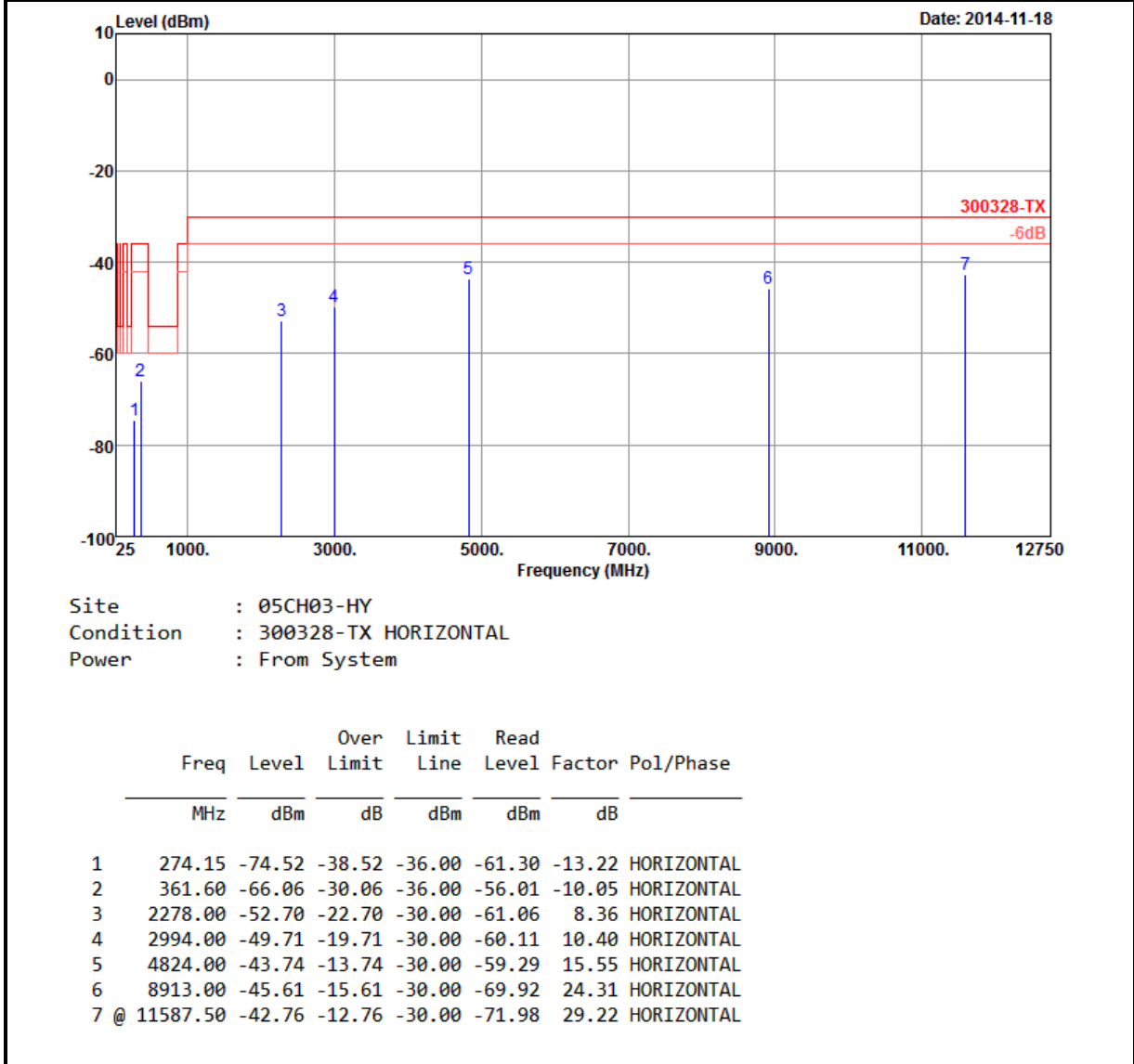



Test Mode :	802.11b CH01 (2412MHz) for Ant. 1	Temperature :	23~24°C
Test Engineer :	Pony Chen	Relative Humidity :	43~44%
		Polarization :	Vertical

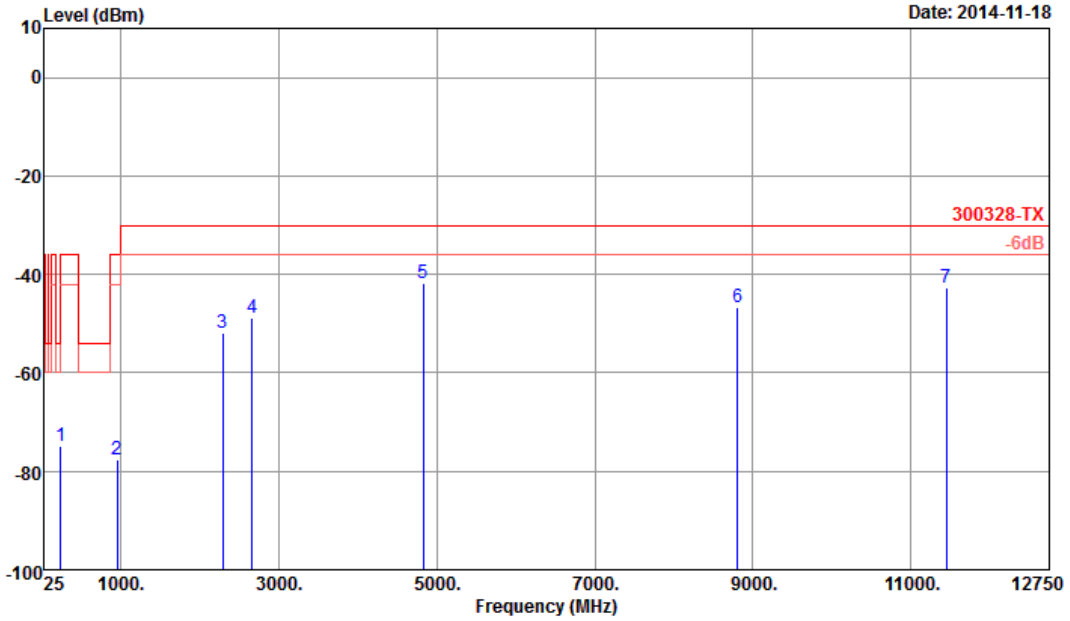

Site : 05CH03-HY
 Condition : 300328-TX VERTICAL
 Power : From System

	Freq	Level	Over Limit	Limit Line	Read Level	Factor	Pol/Phase
	MHz	dBm	dB	dBm	dBm	dB	
1	238.95	-74.90	-38.90	-36.00	-59.37	-15.53	VERTICAL
2	957.30	-77.50	-41.50	-36.00	-76.01	-1.49	VERTICAL
3	2290.00	-51.92	-21.92	-30.00	-60.46	8.54	VERTICAL
4	2666.00	-48.92	-18.92	-30.00	-58.06	9.14	VERTICAL
5 @	4824.00	-41.77	-11.77	-30.00	-57.04	15.27	VERTICAL
6	8808.00	-46.61	-16.61	-30.00	-70.44	23.83	VERTICAL
7	11445.00	-42.69	-12.69	-30.00	-71.71	29.02	VERTICAL



Test Mode :	802.11g CH01 (2412MHz) for Ant. 1	Temperature :	23~24°C
Test Engineer :	Pony Chen	Relative Humidity :	43~44%
		Polarization :	Horizontal

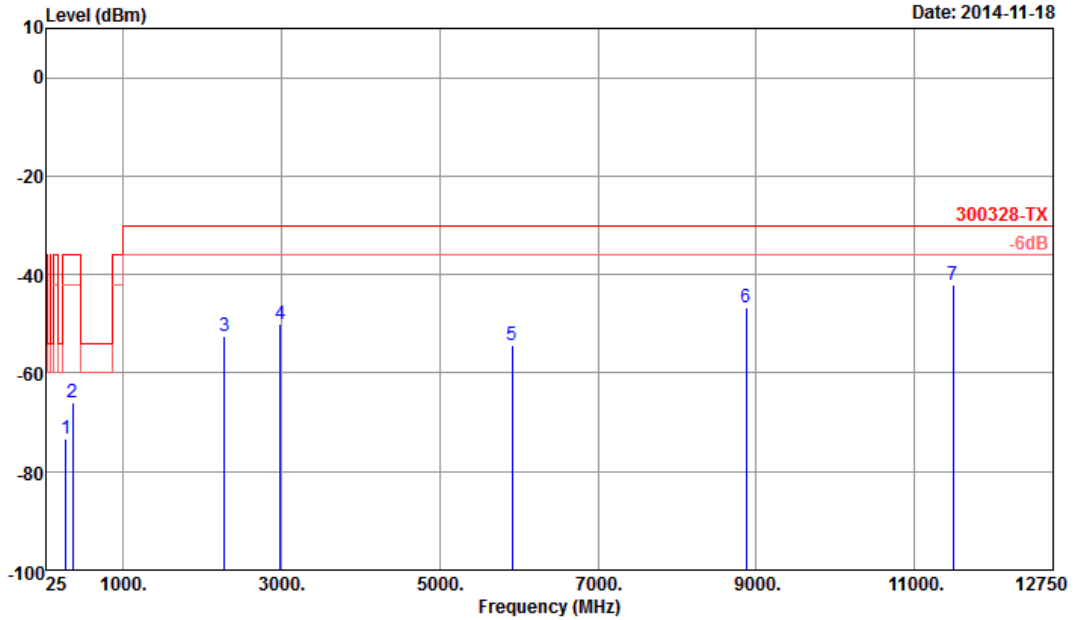

Site : 05CH03-HY
 Condition : 300328-TX HORIZONTAL
 Power : From System

	Freq	Level	Over	Limit	Read		
	MHz	dBm	Limit	Line	Level	Factor	Pol/Phase
			dB	dBm	dBm	dB	
1	277.18	-73.45	-37.45	-36.00	-60.28	-13.17	HORIZONTAL
2	361.60	-65.94	-29.94	-36.00	-55.89	-10.05	HORIZONTAL
3	2280.00	-52.48	-22.48	-30.00	-60.84	8.36	HORIZONTAL
4	2984.00	-50.04	-20.04	-30.00	-60.44	10.40	HORIZONTAL
5	5919.00	-54.27	-24.27	-30.00	-71.56	17.29	HORIZONTAL
6	8871.00	-46.77	-16.77	-30.00	-70.98	24.21	HORIZONTAL
7 @	11486.25	-42.12	-12.12	-30.00	-71.45	29.33	HORIZONTAL



Test Mode :	802.11g CH01 (2412MHz) for Ant. 1	Temperature :	23~24°C
Test Engineer :	Pony Chen	Relative Humidity :	43~44%
		Polarization :	Vertical

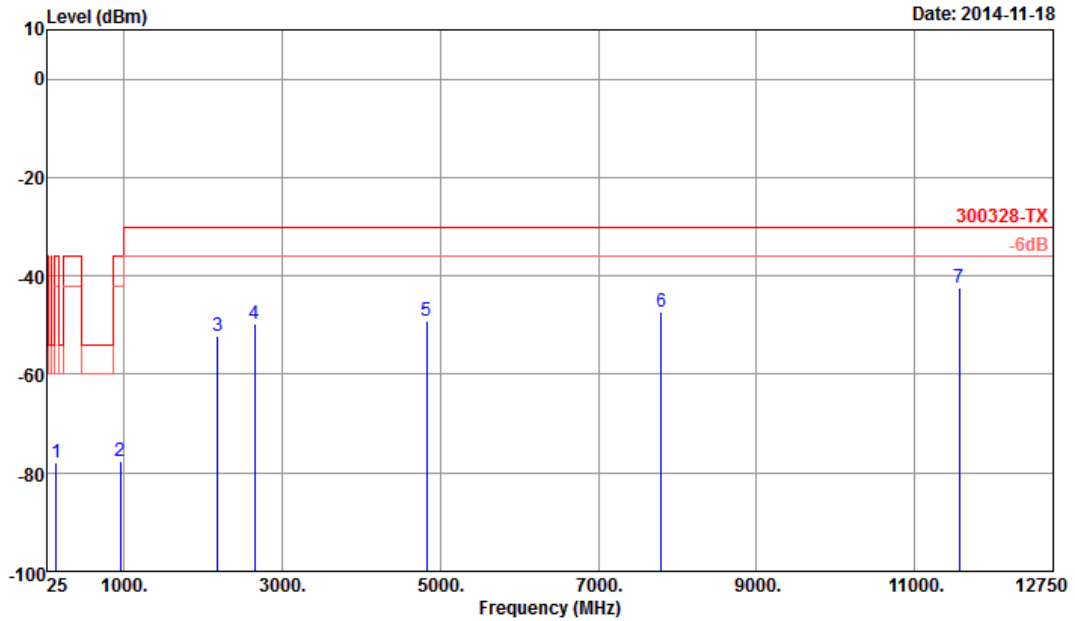

Site : 05CH03-HY
 Condition : 300328-TX VERTICAL
 Power : From System

	Freq	Level	Over Limit	Limit Line	Read Level	Factor	Pol/Phase
	MHz	dBm	dB	dBm	dBm	dB	
1	139.68	-77.99	-41.99	-36.00	-64.00	-13.99	VERTICAL
2	957.30	-77.55	-41.55	-36.00	-76.06	-1.49	VERTICAL
3	2190.00	-52.30	-22.30	-30.00	-60.22	7.92	VERTICAL
4	2656.00	-49.88	-19.88	-30.00	-59.01	9.13	VERTICAL
5	4824.00	-49.25	-19.25	-30.00	-64.52	15.27	VERTICAL
6	7797.00	-47.39	-17.39	-30.00	-70.54	23.15	VERTICAL
7 @	11561.25	-42.44	-12.44	-30.00	-71.49	29.05	VERTICAL



Test Mode :	802.11n HT20 CH01 (2412MHz) for MIMO <Ant. 1+2>	Temperature :	23~24°C
Test Engineer :	Pony Chen	Relative Humidity :	43~44%
		Polarization :	Horizontal

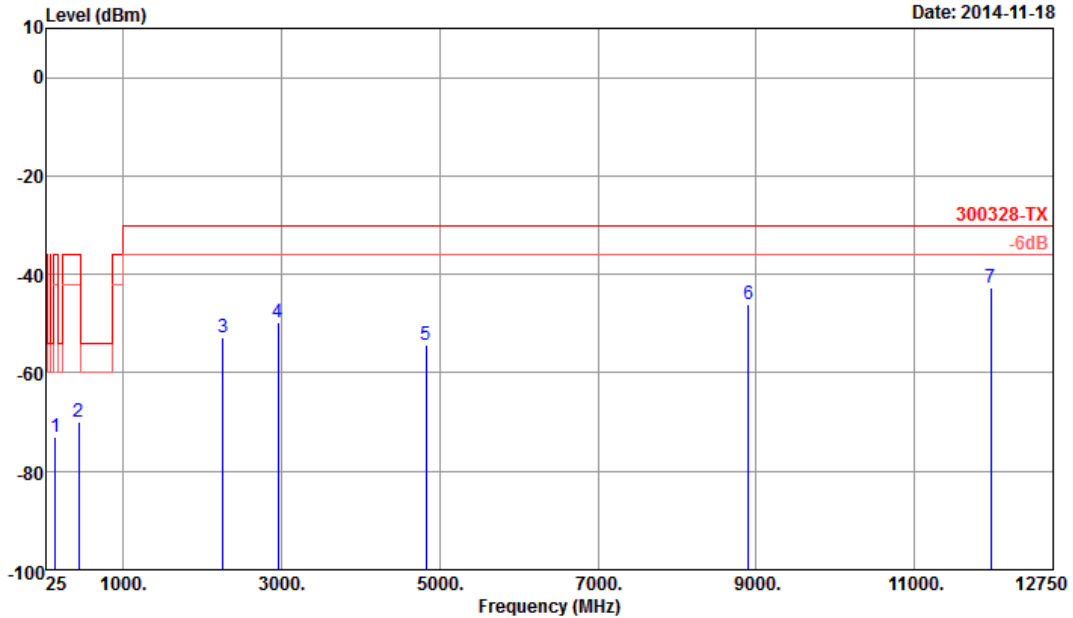

Site : 05CH03-HY
 Condition : 300328-TX HORIZONTAL
 Power : From System

	Freq	Level	Over Limit	Limit Line	Read Level	Factor	Pol/Phase
	MHz	dBm	dB	dBm	dBm	dB	
1	144.08	-72.99	-36.99	-36.00	-59.13	-13.86	HORIZONTAL
2	438.60	-70.00	-34.00	-36.00	-62.21	-7.79	HORIZONTAL
3	2264.00	-52.67	-22.67	-30.00	-60.94	8.27	HORIZONTAL
4	2962.00	-49.86	-19.86	-30.00	-60.14	10.28	HORIZONTAL
5	4824.00	-54.30	-24.30	-30.00	-69.85	15.55	HORIZONTAL
6	8904.00	-46.02	-16.02	-30.00	-70.33	24.31	HORIZONTAL
7 @	11962.50	-42.73	-12.73	-30.00	-71.33	28.60	HORIZONTAL



Test Mode :	802.11n HT20 CH01 (2412MHz) for MIMO <Ant. 1+2>	Temperature :	23~24°C
Test Engineer :	Pony Chen	Relative Humidity :	43~44%
		Polarization :	Vertical

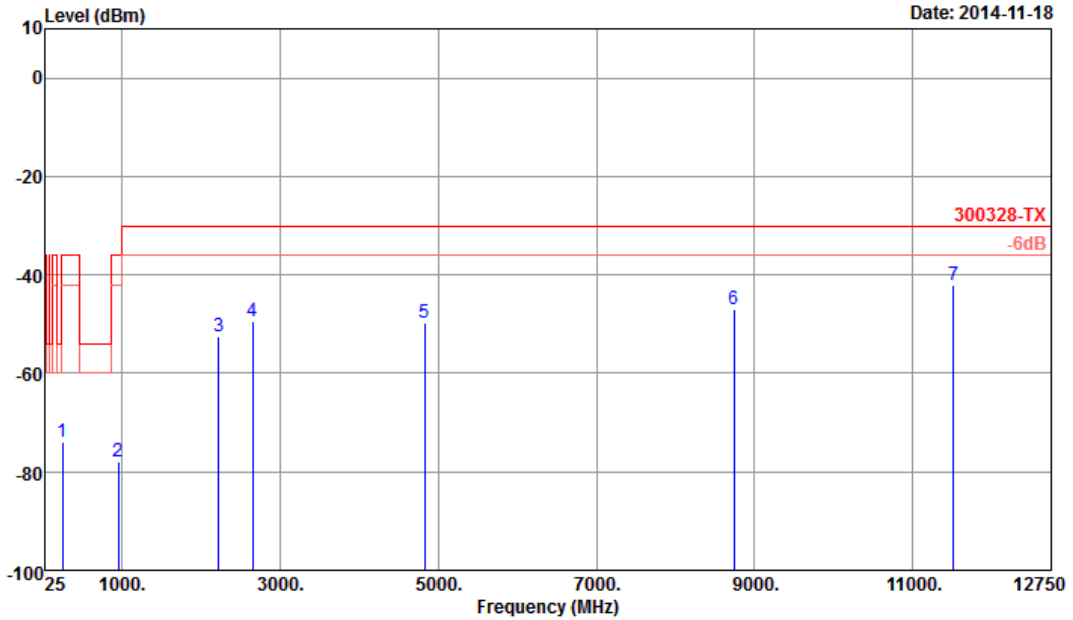

Site : 05CH03-HY
 Condition : 300328-TX VERTICAL
 Power : From System

	Freq	Level	Over	Limit	Read		
	MHz	dBm	Limit	Line	Level	Factor	Pol/Phase
			dB	dBm	dBm	dB	
1	247.20	-73.99	-37.99	-36.00	-58.41	-15.58	VERTICAL
2	957.30	-77.88	-41.88	-36.00	-76.39	-1.49	VERTICAL
3	2222.00	-52.52	-22.52	-30.00	-60.65	8.13	VERTICAL
4	2654.00	-49.29	-19.29	-30.00	-58.42	9.13	VERTICAL
5	4824.00	-49.60	-19.60	-30.00	-64.87	15.27	VERTICAL
6	8742.00	-46.98	-16.98	-30.00	-70.64	23.66	VERTICAL
7 @	11516.25	-42.00	-12.00	-30.00	-71.12	29.12	VERTICAL



Test Mode :	802.11n HT40 CH03 (2422MHz) for Ant. 1	Temperature :	23~24°C
Test Engineer :	Pony Chen	Relative Humidity :	43~44%
		Polarization :	Horizontal

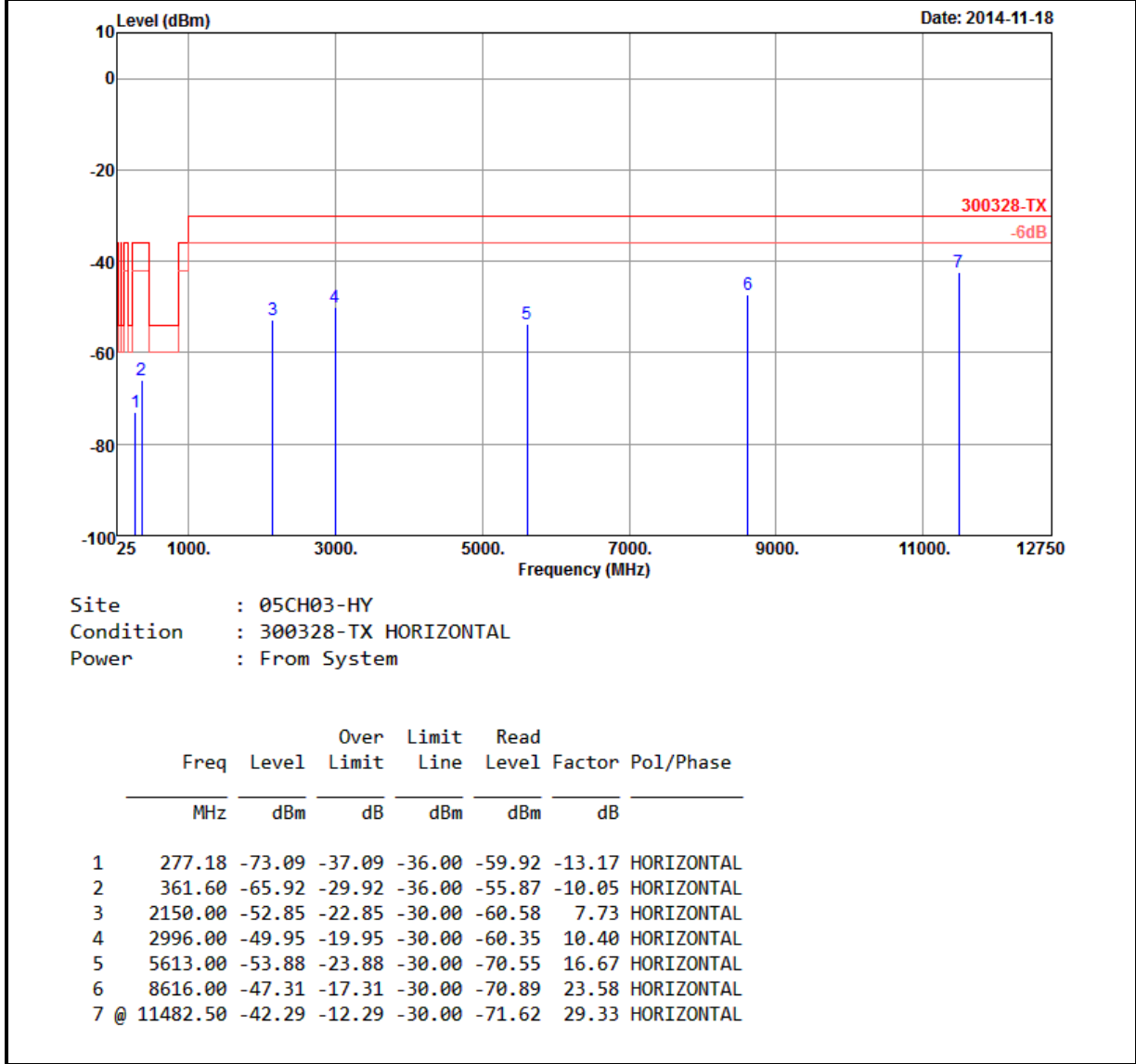



Test Mode :	802.11n HT40 CH03 (2422MHz) for Ant. 1	Temperature :	23~24°C
Test Engineer :	Pony Chen	Relative Humidity :	43~44%
		Polarization :	Vertical

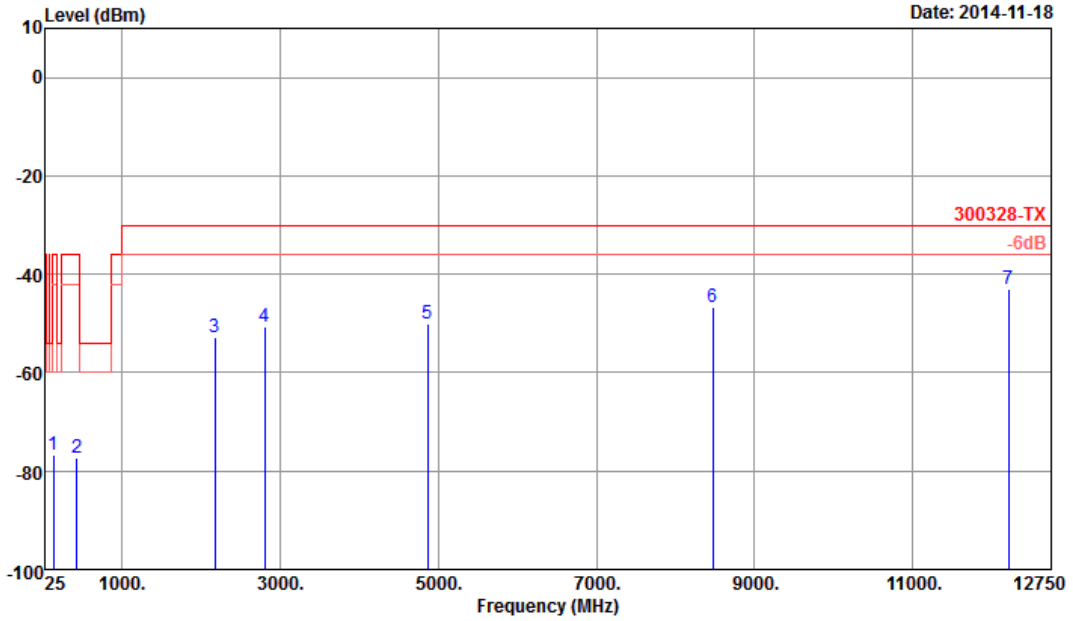

Site : 05CH03-HY
 Condition : 300328-TX VERTICAL
 Power : From System

	Freq	Level	Over Limit	Limit Line	Read Level	Factor	Pol/Phase
	MHz	dBm	dB	dBm	dBm	dB	
1	138.58	-76.73	-40.73	-36.00	-62.64	-14.09	VERTICAL
2	435.10	-77.40	-41.40	-36.00	-69.71	-7.69	VERTICAL
3	2178.00	-52.76	-22.76	-30.00	-60.57	7.81	VERTICAL
4	2802.00	-50.67	-20.67	-30.00	-60.23	9.56	VERTICAL
5	4863.00	-49.96	-19.96	-30.00	-65.70	15.74	VERTICAL
6	8472.00	-46.82	-16.82	-30.00	-69.87	23.05	VERTICAL
7 @	12210.00	-42.90	-12.90	-30.00	-71.32	28.42	VERTICAL

4 Receiver Parameters

4.1 Receiver spurious emissions

4.1.1 Limit of Receiver spurious emissions

FHSS spurious emission limits for receivers:

SUBCLAUSE 4.3.1.10.2		
FREQUENCY RANGE	MAXIMUM POWER E.R.P. (\leq 1 GHz) E.I.R.P. ($>$ 1 GHz)	MEASUREMENT BANDWIDTH
30 MHz to 1 GHz	-57 dBm	100kHz
1 GHz to 12,75 GHz	-47 dBm	1MHz

WLAN spurious emission limits for receivers

SUBCLAUSE 4.3.2.9		
FREQUENCY RANGE	MAXIMUM POWER, E.R.P.	MEASUREMENT BANDWIDTH
30 MHz to 1 GHz	-57 dBm	100kHz
1 GHz to 12,75 GHz	-47 dBm	1MHz

4.1.2 Measuring Instruments

The measuring equipment is listed in the section 7 of this test report.

4.1.3 Test Procedures

1. The measurement procedure follows the clause 5.3.11.2.2 of the ETSI EN 300 328 V1.8.1 (2012-06).
2. The EUT was placed on a turntable with 1.5m height.
3. The test distance between the receiving antenna and the EUT is 3meter below 1GHz frequency range, and 3 meter which is in far field test condition for measured frequency above 1GHz, while the receiving (test) antenna is kept at 1.5 meter height.
4. Set EUT in receiving mode.
5. The table was rotated from 0 to 360 degree to search the highest radiated emission.
6. Repeating step 3 and 4 for each polarization and channel to find the worst emission level.
7. The results obtained are compared to the limits in order to prove compliance with the requirement.

4.1.4 Test Setup

<Conducted Setup>



<Below 1GHz>

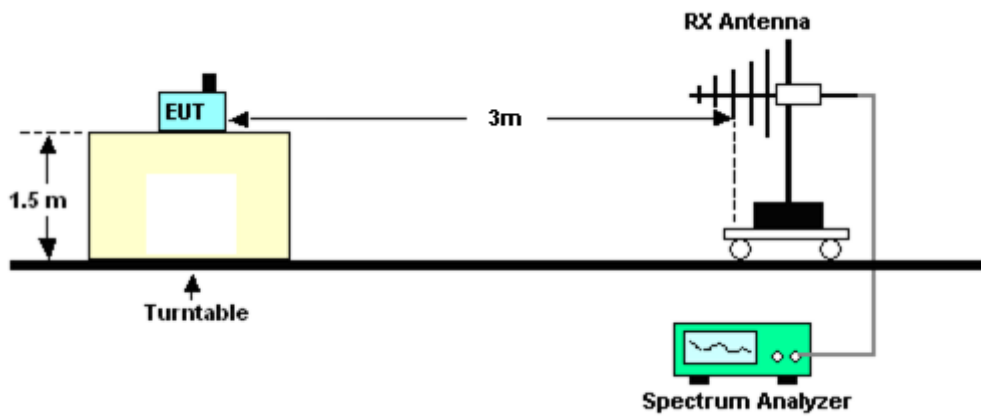

<Above 1GHz>

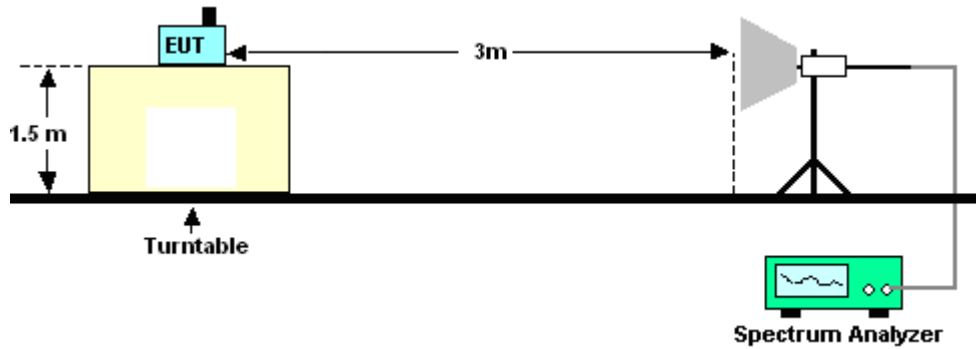



4.1.5 Test Results for Conducted Setup

Number of TX = 1, Ant. 1 (Measured)

Test Mode :	802.11b CH13 (2472MHz) for Ant. 1	Temperature :	24~26°C
Test Engineer :	Eric Shih	Relative Humidity :	42~44%
		Polarization :	Horizontal

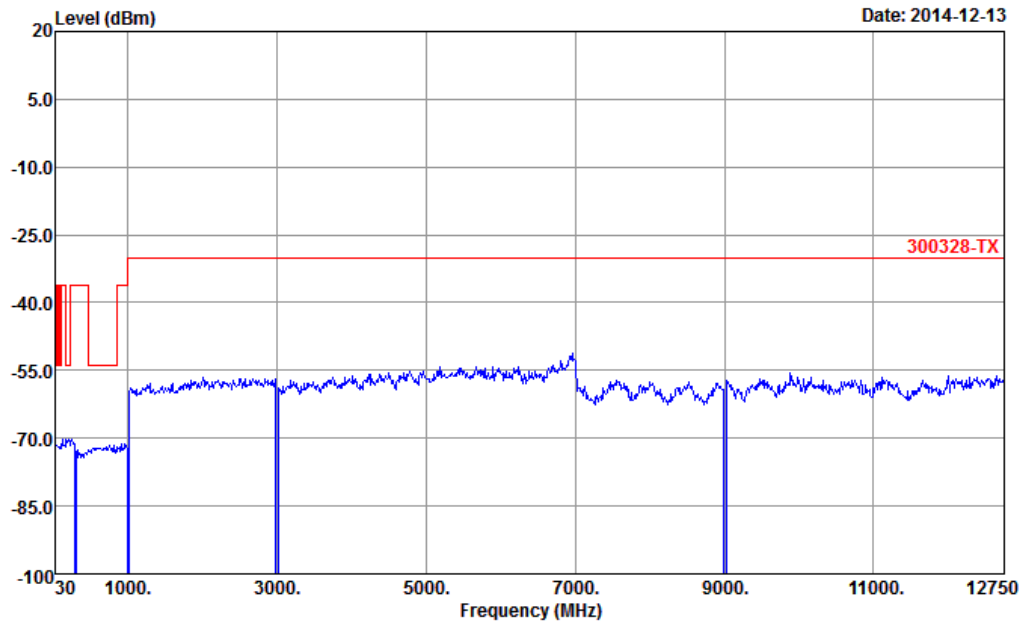

Site : 03CH07-HY
Condition : 300328-TX ANT GAIN+3.2 2.4G



Test Mode :	802.11g CH13 (2472MHz) for Ant. 1	Temperature :	24~26°C
Test Engineer :	Eric Shih	Relative Humidity :	42~44%
		Polarization :	Vertical

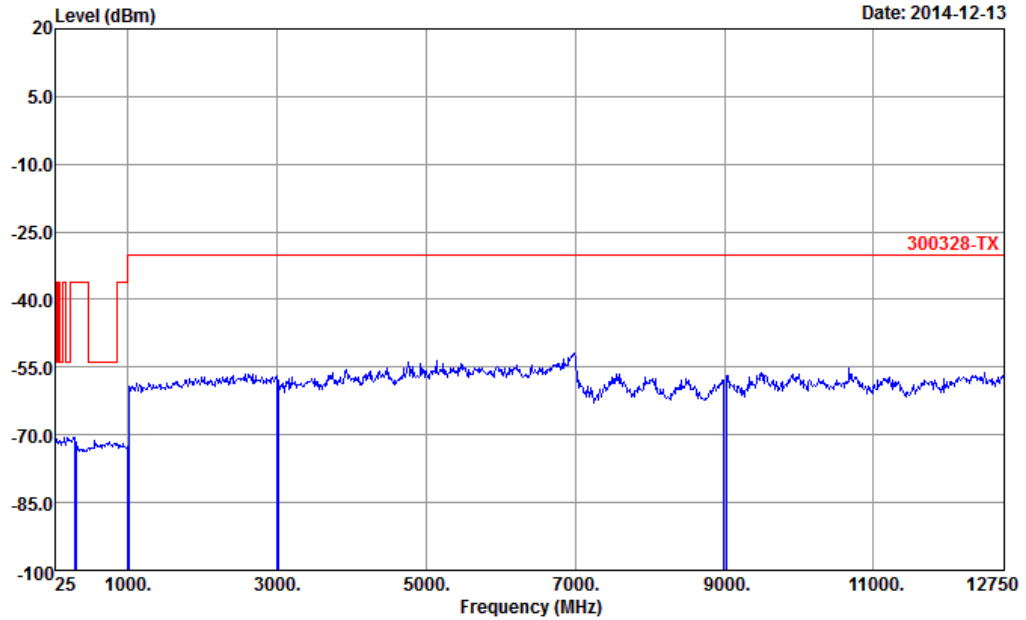

Site : 03CH07-HY
Condition : 300328-TX ANT GAIN+3.2 2.4G



4.1.6 Test Results for Radiated Setup (Cabinet Radiation)

Test Mode :	802.11n HT20 CH01 (2412MHz) for MIMO <Ant. 1+2>	Temperature :	23~24°C
Test Engineer :	Pony Chen	Relative Humidity :	43~44%
		Polarization :	Horizontal

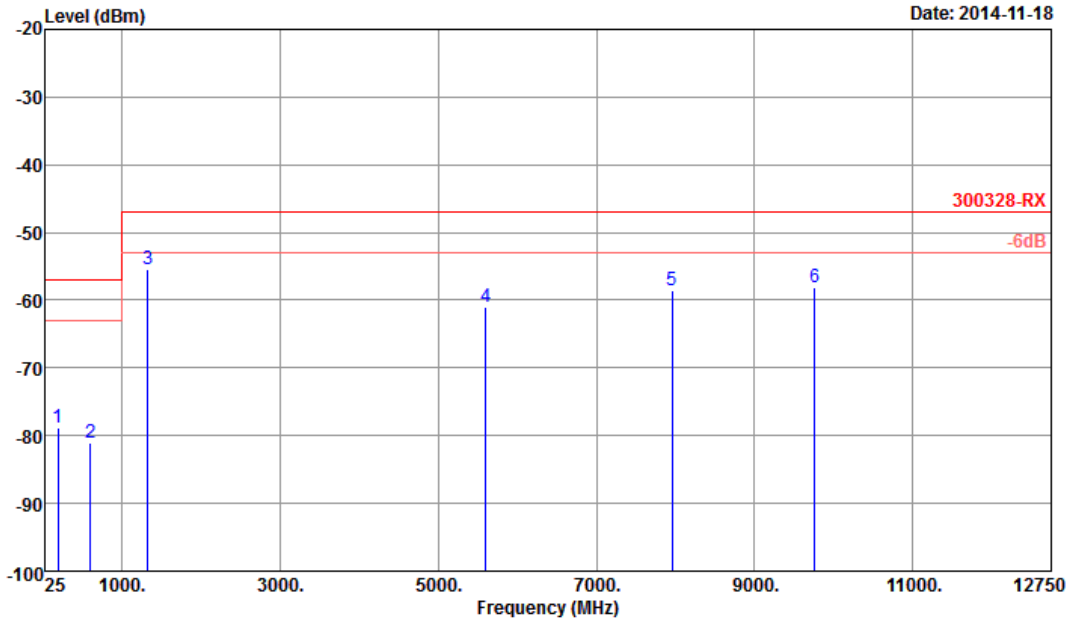

Site : 05CH03-HY
 Condition : 300328-RX HORIZONTAL
 Power : From System

	Freq	Level	Over Limit	Limit Line	Read Level	Factor	Pol/Phase
	MHz	dBm	dB	dBm	dBm	dB	
1	192.75	-78.86	-21.86	-57.00	-66.18	-12.68	HORIZONTAL
2	602.40	-81.01	-24.01	-57.00	-75.99	-5.02	HORIZONTAL
3 @	1330.00	-55.50	-8.50	-47.00	-44.27	-11.23	HORIZONTAL
4	5604.00	-61.07	-14.07	-47.00	-60.68	-0.39	HORIZONTAL
5	7953.00	-58.52	-11.52	-47.00	-63.89	5.37	HORIZONTAL
6	9757.50	-58.18	-11.18	-47.00	-65.71	7.53	HORIZONTAL



Test Mode :	802.11n HT20 CH01 (2412MHz) for MIMO <Ant. 1+2>	Temperature :	23~24°C
Test Engineer :	Pony Chen	Relative Humidity :	43~44%
		Polarization :	Vertical

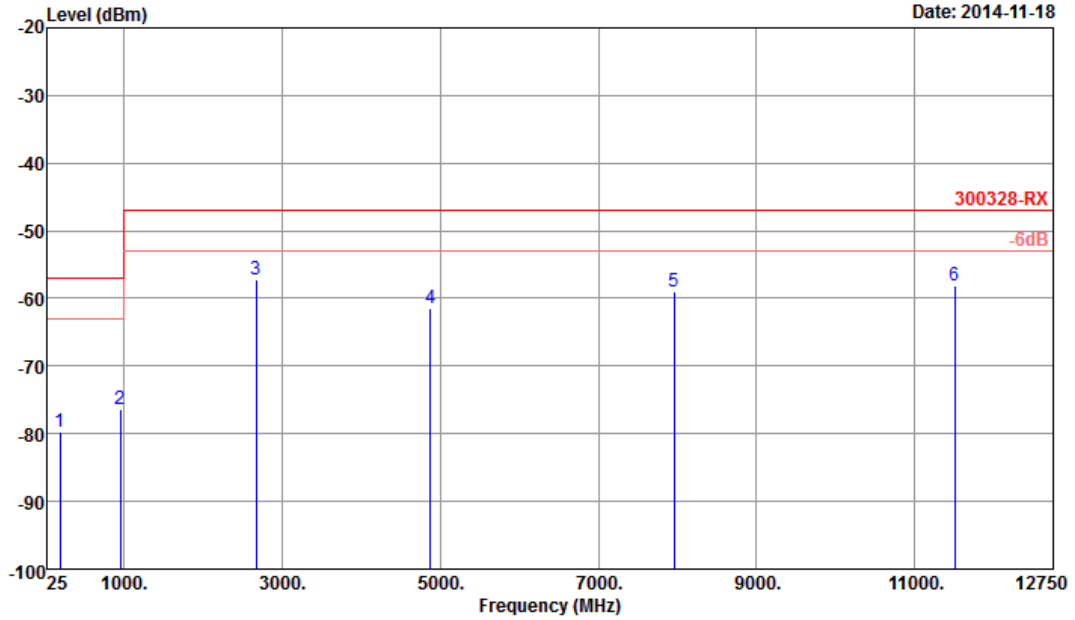

Site : 05CH03-HY
 Condition : 300328-RX VERTICAL
 Power : From System

	Freq	Level	Over Limit	Limit Line	Read Level	Factor	Pol/Phase
	MHz	dBm	dB	dBm	dBm	dB	
1	190.55	-79.75	-22.75	-57.00	-68.65	-11.10	VERTICAL
2	957.30	-76.40	-19.40	-57.00	-74.91	-1.49	VERTICAL
3 @	2670.00	-57.20	-10.20	-47.00	-49.44	-7.76	VERTICAL
4	4875.00	-61.56	-14.56	-47.00	-60.11	-1.45	VERTICAL
5	7956.00	-59.09	-12.09	-47.00	-64.42	5.33	VERTICAL
6	11501.25	-58.21	-11.21	-47.00	-66.89	8.68	VERTICAL

5 Adaptivity Test

5.1 Adaptivity and Receiver Blocking

5.1.1 Limit of Adaptivity and Receiver Blocking

Only for adaptive systems and RF Output Power > 10 dBm

LBT based Detect and Avoid (Load Based Equipment with spectrum sharing mechanism IEEE Std.):

LBT based spectrum sharing mechanism may implement IEEE Std. 802.11-2007 clauses 15, 17, 18 or 19, in IEEE Std. 802.11n-2009, clause 20 or in IEEE Std. 802.15.4-2006,

Short Control Signaling Transmissions shall have a maximum duty cycle of 10 % within an observation period of 50 ms.

5.1.2 Measurement Instruments

The measuring equipment is listed in the section 7 of this test report.

5.1.3 Test Procedures

1. The measurement procedure follows the clause 5.3.7.2.1 of the ETSI EN 300 328 V1.8.1 (2012-06).
2. For conducted measurements on devices with multiple transmit chains and receive chains. The power splitter/combiner shall be used to combine all the transmit/receive chains (antenna outputs) into a single test point. The insertion loss of the power splitter/combiner shall be taken into account.

5.1.4 Test Setup

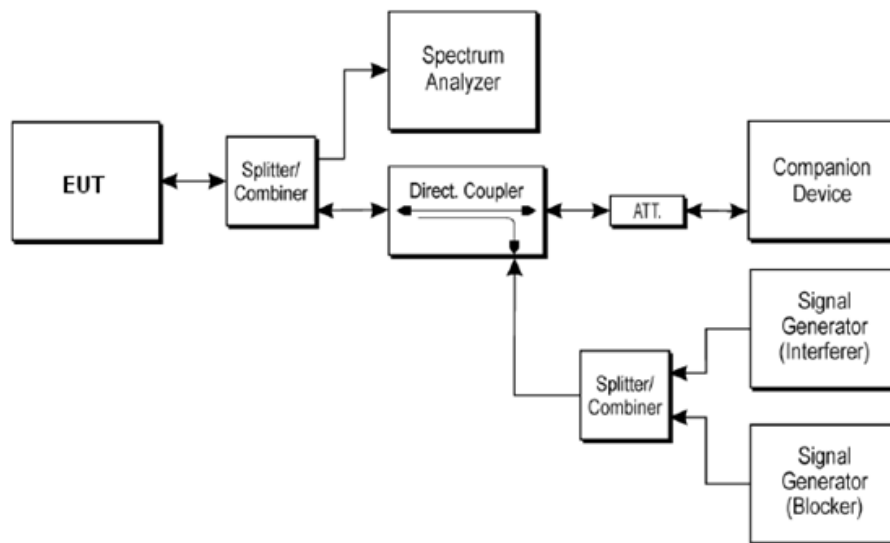



5.1.5 Support Unit used in test configuration and system

Item	Instrument	Manufacturer	Model No.	Characteristics
1.	WLAN AP	Motorola	AP7131N	Dual Band AP
2.	Notebook	Lenovo	E335	FTP / LAN

5.1.6 Test Results of Adaptivity and Receiver Blocking

Equipment Information:	
<input type="checkbox"/>	Non-Adaptive Equipment
	The maximum RF output power (E.I.R.P.) dBm:
	The maximum (Corresponding) Duty Cycle : %
<input checked="" type="checkbox"/>	Adaptive Equipment without the possibility to switch to a non-adaptive mode:
<input checked="" type="checkbox"/>	The equipment has implemented an LBT based DAA mechanism:
	<input type="checkbox"/> The equipment is Frame Based equipment
	<input checked="" type="checkbox"/> The equipment is Load Based equipment
	<input type="checkbox"/> The equipment can switch dynamically between Frame Based and Load Based equipment
<input type="checkbox"/>	The equipment has implemented an non-LBT based DAA mechanism
<input type="checkbox"/>	The equipment can operate in more than one adaptive mode
<input type="checkbox"/>	Adaptive Frequency Hopping using other forms of DAA (non-LBT based)
<input type="checkbox"/>	Adaptive Equipment which can also operate in non-adaptive mode

	Modulation	Data Rate (single)	Nominal Bandwidth	Channel	Test Frequency	Test Result
WIFI 2.4GHz	802.11b	11Mbit/s	20MHz	01	2412 MHz	PASS
				13	2472 MHz	PASS
	802.11g	54Mbit/s	20MHz	01	2412 MHz	PASS
				13	2472 MHz	PASS
	802.11n HT20	65Mbit/s	20MHz	01	2412 MHz	PASS
				13	2472 MHz	PASS
	802.11n HT40	135 Mbit/s	40MHz	03	2422 MHz	PASS
				11	2462 MHz	PASS

Note: The CCA time is declared by the manufacturer.



5.1.7 Test Plots of Adaptivity Test

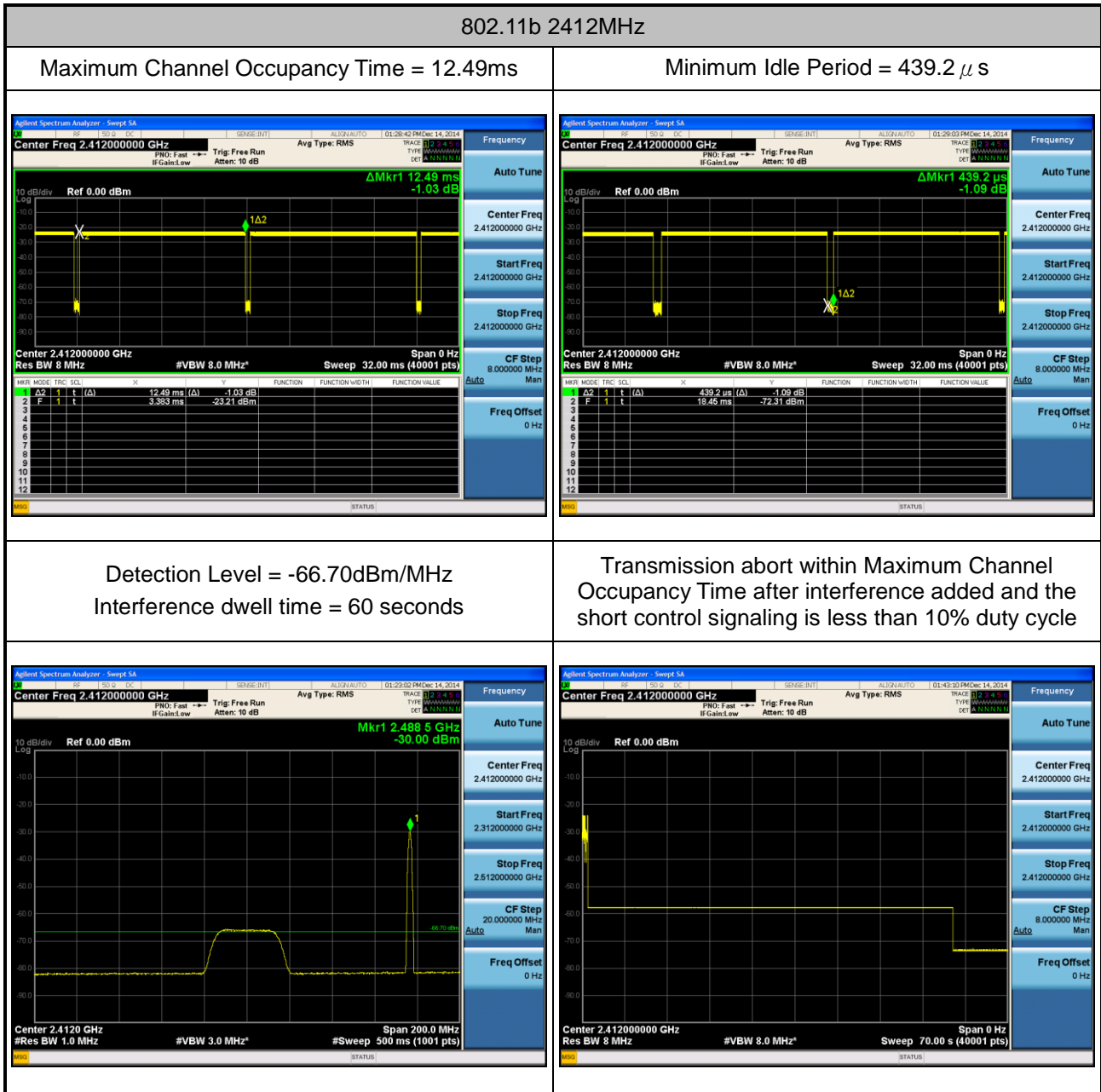

Note: Detection Level = -70 + 20 – EIRP + Gain for conducted measurement.



802.11b 2472MHz

Maximum Channel Occupancy Time = 12.49ms

Minimum Idle Period = 420.0 μ s

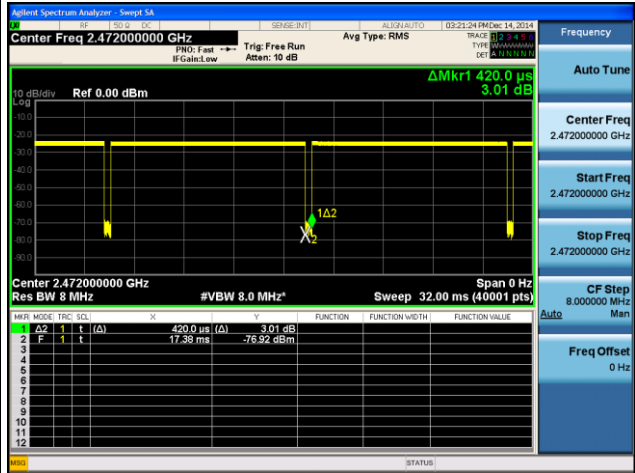
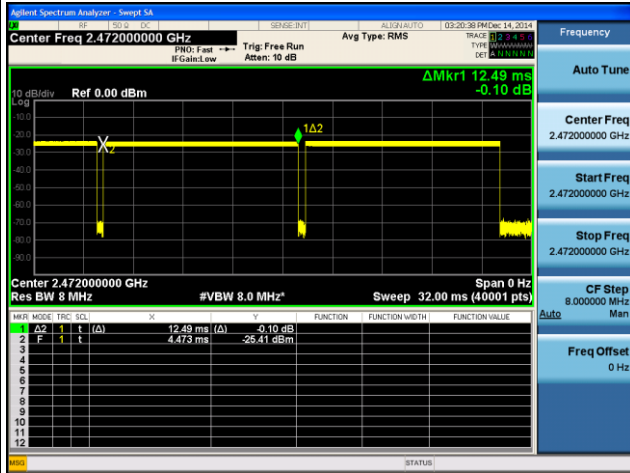

Detection Level = -66.70dBm/MHz
Interference dwell time = 60 seconds

Transmission abort within Maximum Channel Occupancy Time after interference added and the short control signaling is less than 10% duty cycle

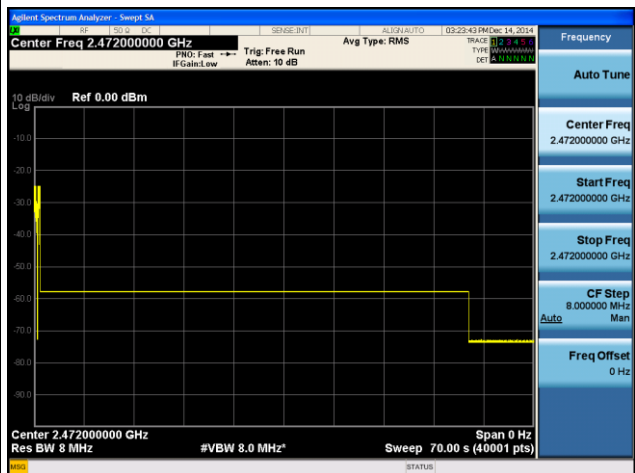
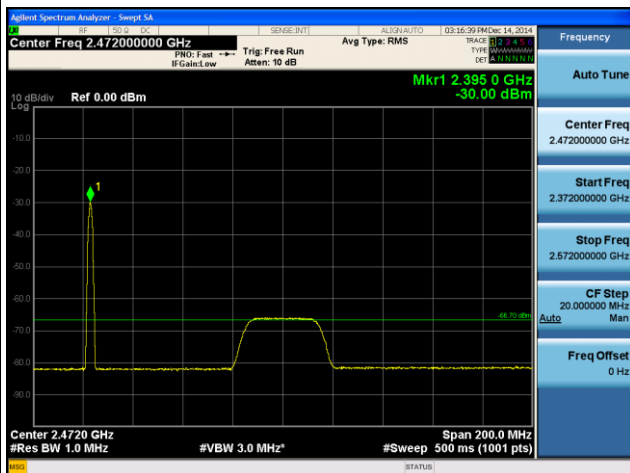

Note: Detection Level = -70 + 20 – EIRP + Gain for conducted measurement.



802.11g 2412MHz

Maximum Channel Occupancy Time = 2.076ms

Minimum Idle Period = 128.2 μ s

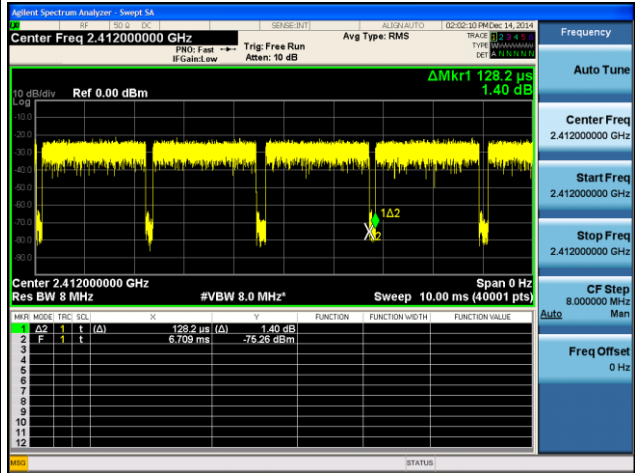
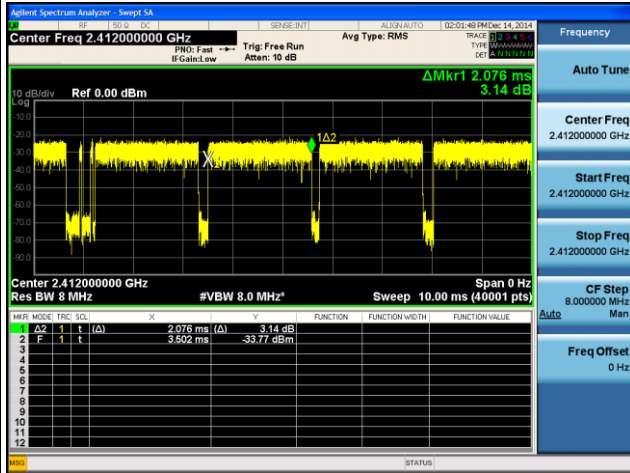

Detection Level = -66.70dBm/MHz
 Interference dwell time = 60 seconds

Transmission abort within Maximum Channel Occupancy Time after interference added and the short control signaling is less than 10% duty cycle

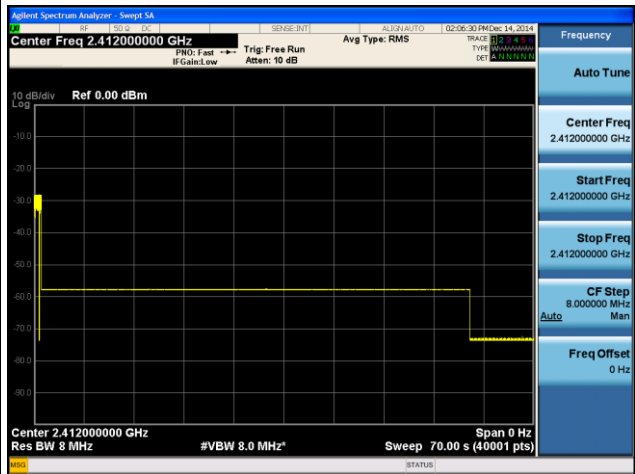
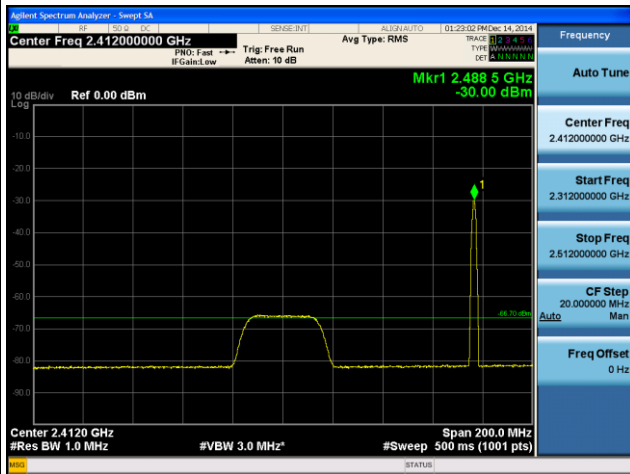

Note: Detection Level = -70 + 20 – EIRP + Gain for conducted measurement.



802.11g 2472MHz

Maximum Channel Occupancy Time = 2.076ms

Minimum Idle Period = 155.0 μ s

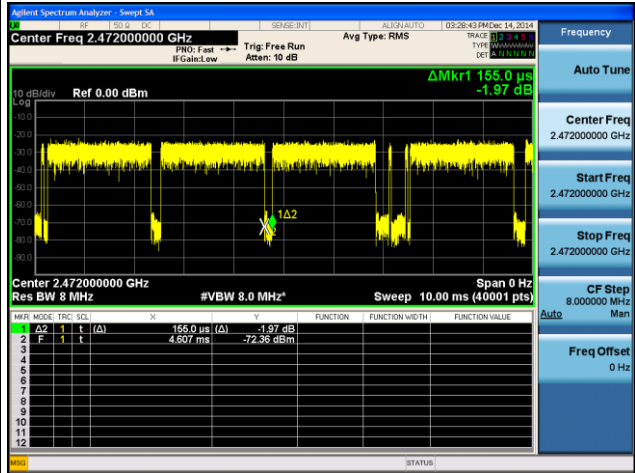
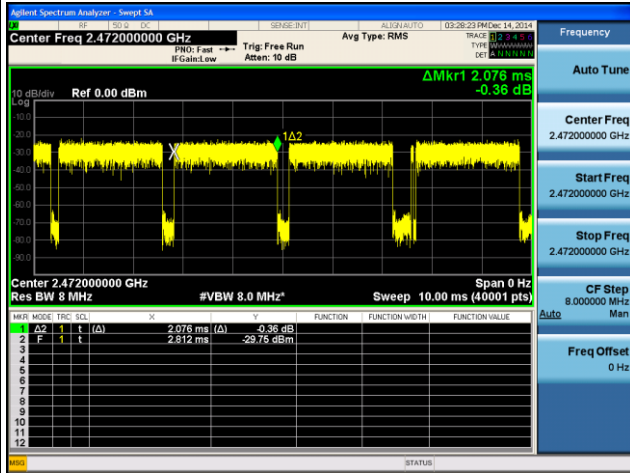

Detection Level = -66.70dBm/MHz
 Interference dwell time = 60 seconds

Transmission abort within Maximum Channel Occupancy Time after interference added and the short control signaling is less than 10% duty cycle

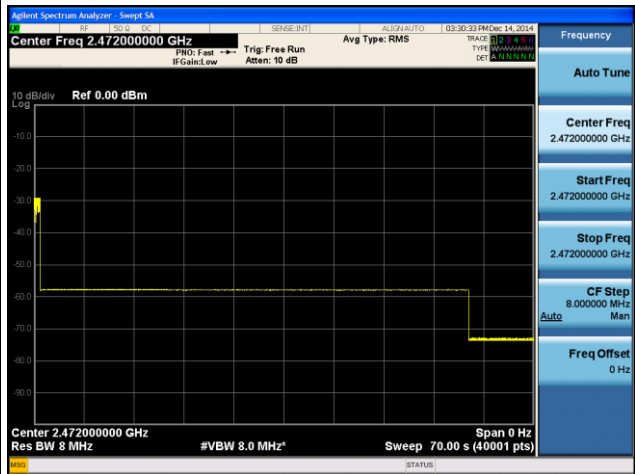
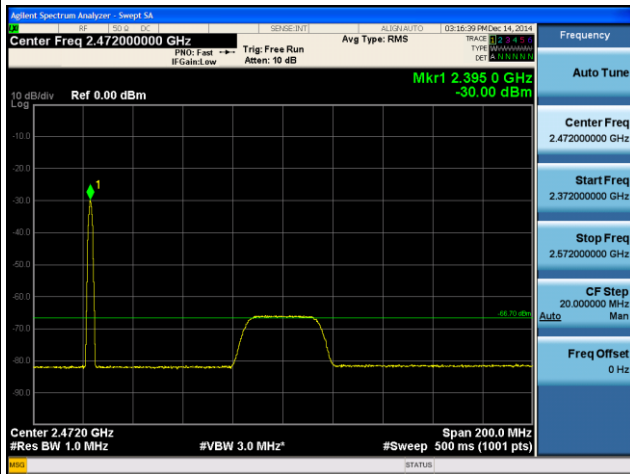

Note: Detection Level = -70 + 20 – EIRP + Gain for conducted measurement.



802.11n HT20 2412MHz

Maximum Channel Occupancy Time = 4.472ms

Minimum Idle Period = 151.9 μ s

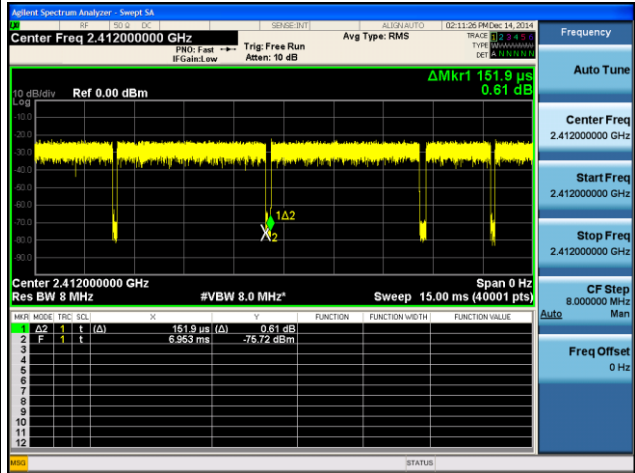
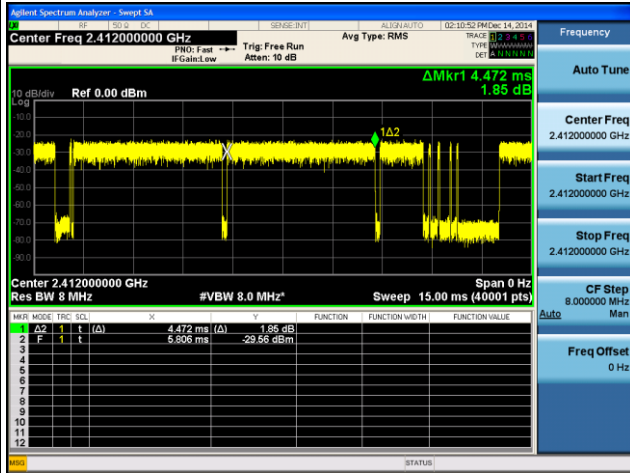

Detection Level = -66.70dBm/MHz
 Interference dwell time = 60 seconds

Transmission abort within Maximum Channel Occupancy Time after interference added and the short control signaling is less than 10% duty cycle

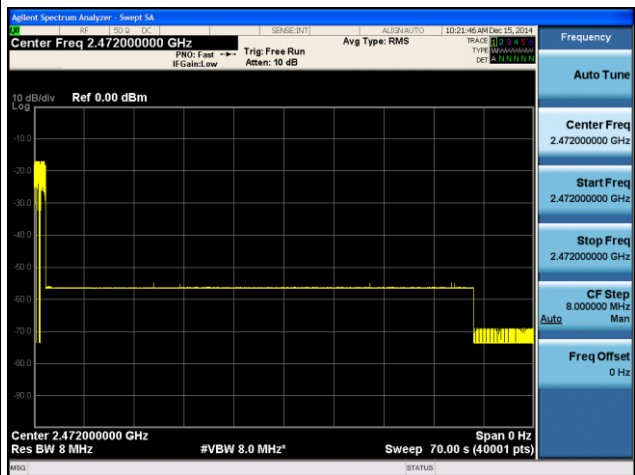
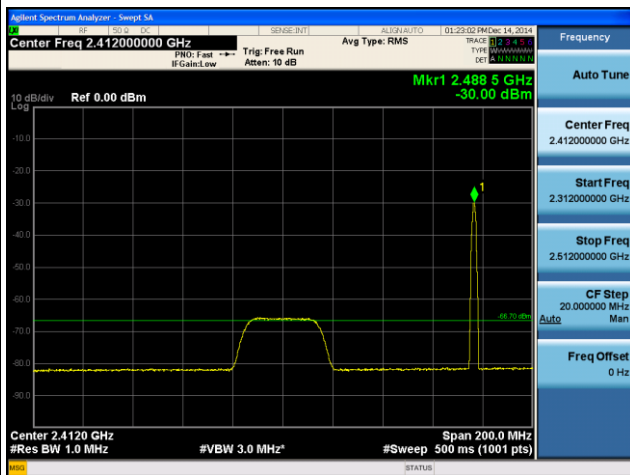

Note: Detection Level = -70 + 20 – EIRP + Gain for conducted measurement.



802.11n HT20 2472MHz

Maximum Channel Occupancy Time = 2.700ms

Minimum Idle Period = 134.3 μ s

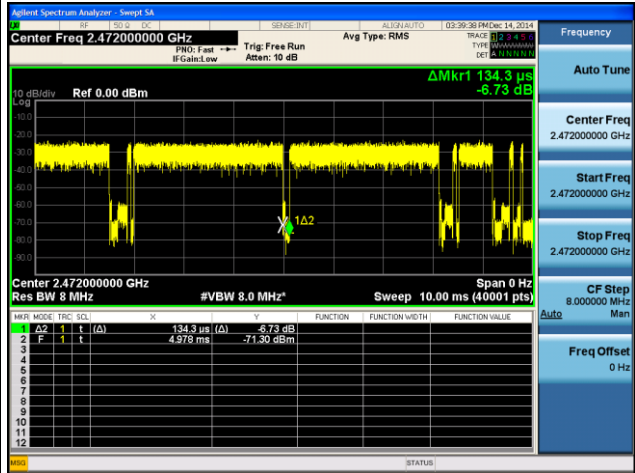
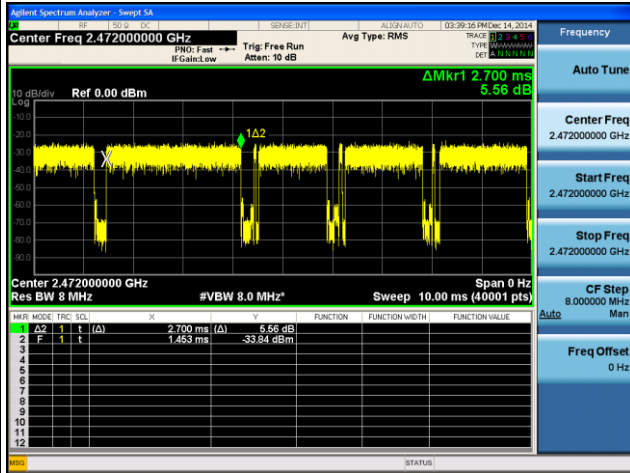

Detection Level = -66.70dBm/MHz
 Interference dwell time = 60 seconds

Transmission abort within Maximum Channel Occupancy Time after interference added and the short control signaling is less than 10% duty cycle

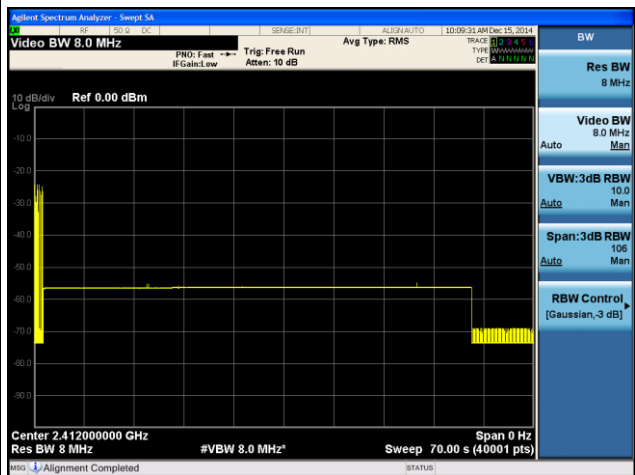
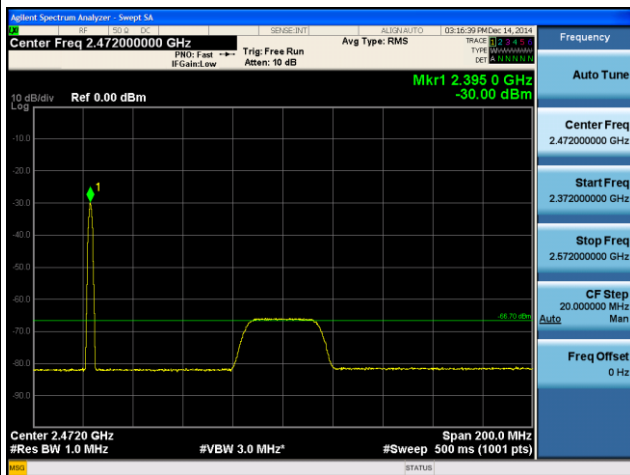

Note: Detection Level = -70 + 20 – EIRP + Gain for conducted measurement.



802.11n HT40 2422MHz

Maximum Channel Occupancy Time = 1.638ms

Minimum Idle Period = 179.3 μ s

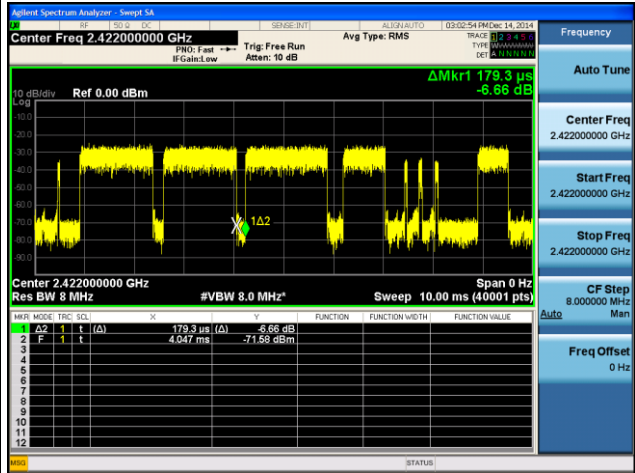
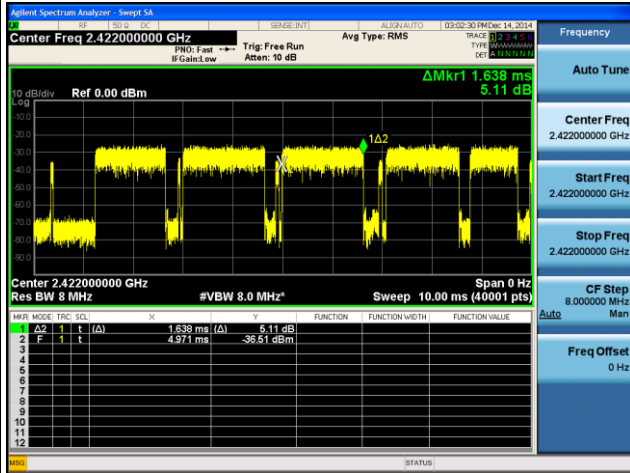

Detection Level = -66.70dBm/MHz
Interference dwell time = 60 seconds

Transmission abort within Maximum Channel Occupancy Time after interference added and the short control signaling is less than 10% duty cycle

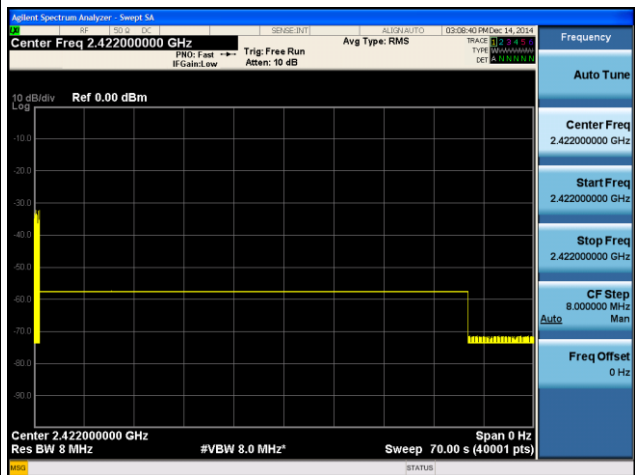
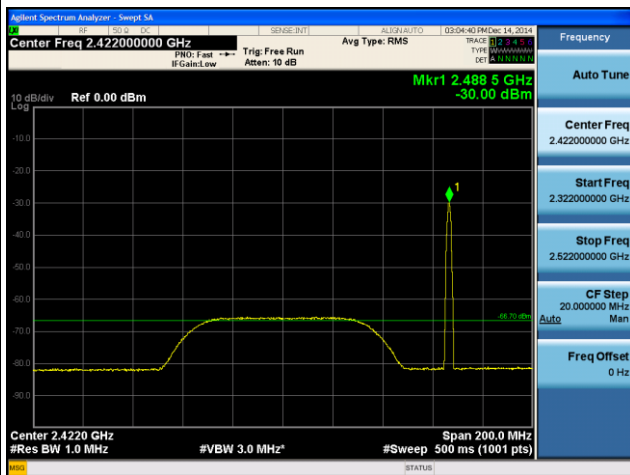

Note: Detection Level = -70 + 20 – EIRP + Gain for conducted measurement.



802.11n HT40 2462MHz

Maximum Channel Occupancy Time = 1.524ms

Minimum Idle Period = 233.7 μs

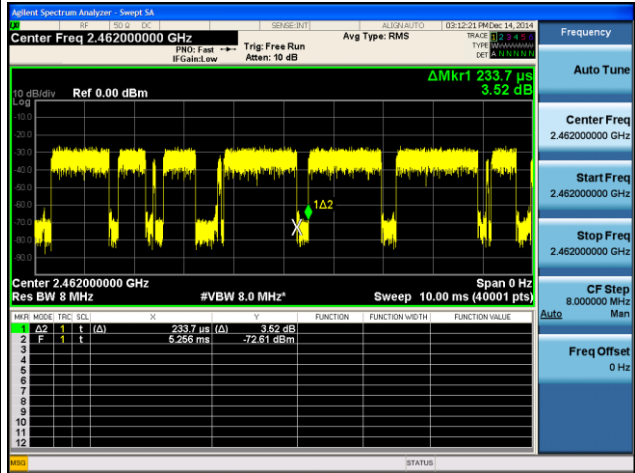
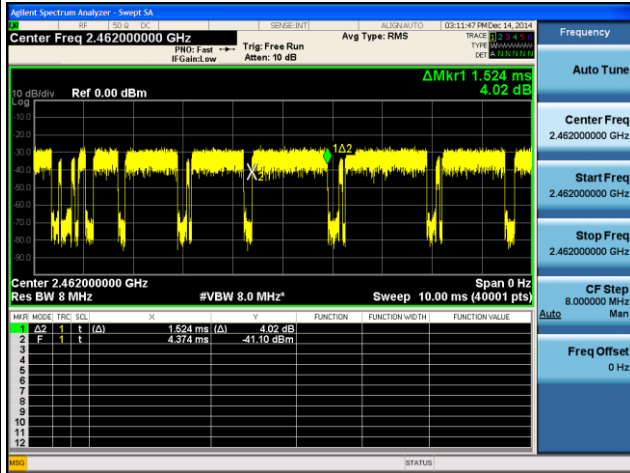

Detection Level = -66.70dBm/MHz
Interference dwell time = 60 seconds

Transmission abort within Maximum Channel Occupancy Time after interference added and the short control signaling is less than 10% duty cycle

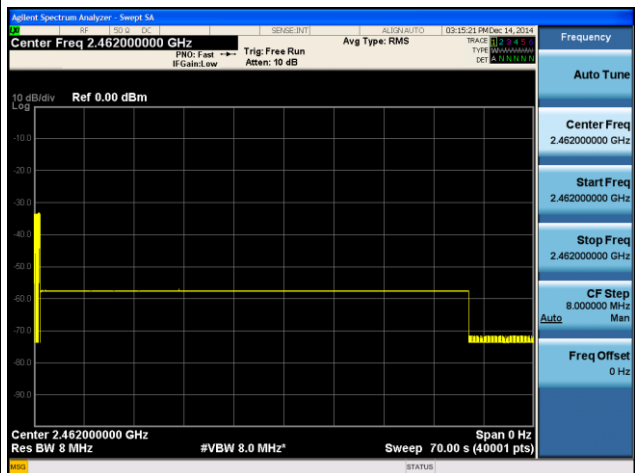
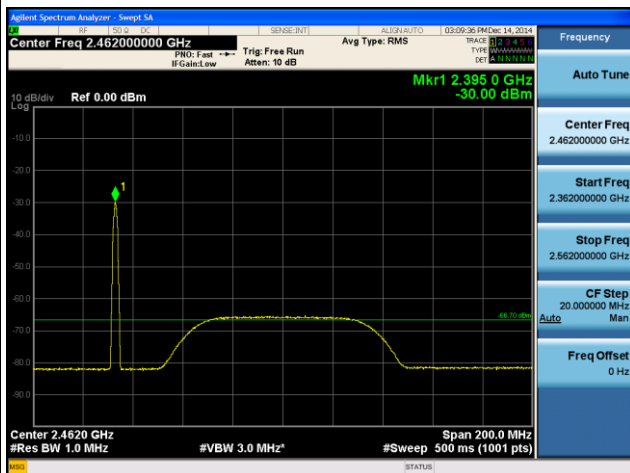

Note: Detection Level = -70 + 20 – EIRP + Gain for conducted measurement.

6 Photographs of Radiated Emission Test Configuration

LF



HF

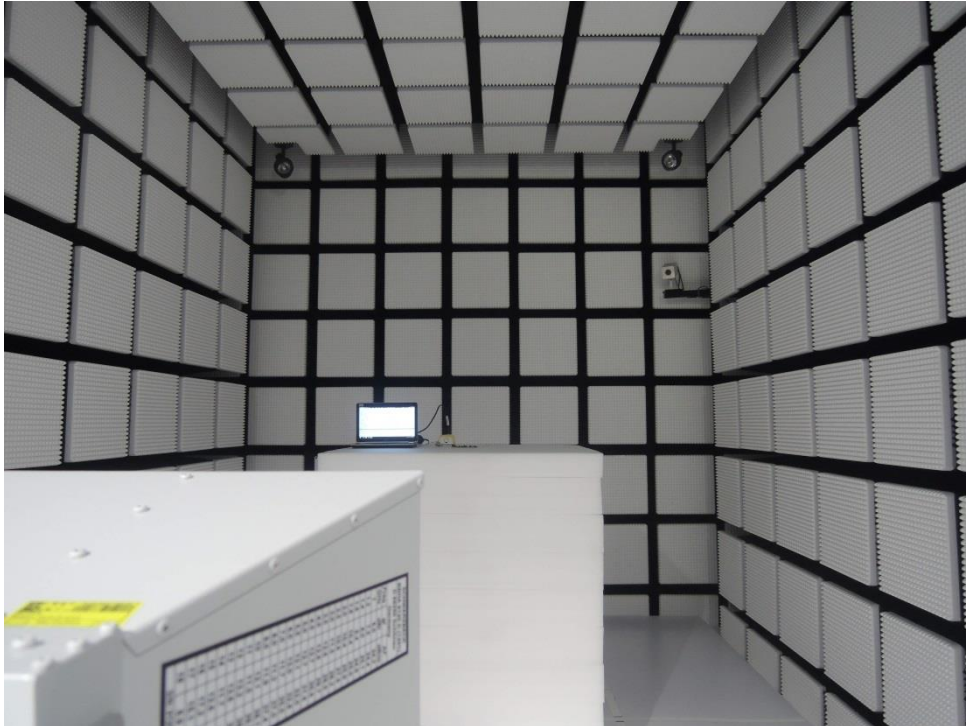



7 List of Measuring Equipment

Instrument	Manufacturer	Model No.	Serial No.	Characteristics	Calibration Date	Test Date	Due Date	Remark
Spectrum Analyzer	Rohde & Schwarz	FSP40	100055	9kHz~40GHz	Jun. 09, 2014	Dec. 10, 2014 ~ Dec. 11, 2014	Jun. 08, 2015	Conducted (TH02-HY)
Power Meter	DARE	RPR3006W	13I00030SN O31	9kHz~6GHz	Sep. 30, 2014	Dec. 10, 2014 ~ Dec. 11, 2014	Sep. 29, 2015	Conducted (TH02-HY)
Thermal Chamber	Ten Billion	TTH-D3SP	TBN-930701	N/A	Jul. 17, 2014	Dec. 10, 2014 ~ Dec. 11, 2014	Jul. 16, 2015	Conducted (TH02-HY)
Signal Analyzer	Rohde & Schwarz	FSQ	200578/026	20Hz~26.5GHz	Feb. 11, 2014	Dec. 10, 2014 ~ Dec. 11, 2014	Feb. 10, 2015	Conducted (TH02-HY)
Signal Generator (Interferer)	Rohde & Schwarz	SMJ100A	101375	9kHz~6GHz	Feb. 19, 2014	Dec. 14, 2014 ~ Dec. 15, 2014	Feb. 18, 2015	Conducted (TH02-HY)
Signal Generator (Blocker)	Rohde & Schwarz	SMU200A	103008	9kHz~3GHz	May 13, 2014	Dec. 14, 2014 ~ Dec. 15, 2014	May 12, 2015	Conducted (TH02-HY)
Spectrum Analyzer	Agilent	N9030A	MY52350276	3Hz~44GHz	Mar. 10, 2014	Dec. 14, 2014 ~ Dec. 15, 2014	Mar. 09, 2015	Conducted (TH02-HY)
Spectrum Analyzer	Agilent	N9010A	MY53470118	10Hz~ 44GHz	Feb. 10, 2014	Nov. 18, 2014	Feb. 09, 2015	Radiation (05CH03-HY)
Bilog Antenna	TDK	HLP-3003C	130776	30MHz ~ 3GHz	Dec. 12, 2013	Nov. 18, 2014	Dec. 11, 2014	Radiation (05CH03-HY)
Double Ridged Guide Horn Antenna	SCHWARZBECK	BBHA 9120 D	BBHA 9120 D 1212	1GHz ~ 18GHz	Mar. 03, 2014	Nov. 18, 2014	Mar. 02, 2015	Radiation (05CH03-HY)
Amplifier	EMCI	EMC001830	980191	10MHz~8GHz	Jan. 27, 2014	Nov. 18, 2014	Jan. 26, 2015	Radiation (05CH03-HY)
Preamplifier	Agilent	8449B	3008A02665	1GHz~26.5GHz	Feb. 10, 2014	Nov. 18, 2014	Feb. 09, 2015	Radiation (05CH03-HY)
Antenna Mast	ChainTek	MD-200	1308055	1m ~ 4m	N/A	Nov. 18, 2014	N/A	Radiation (05CH03-HY)
Turn Table	ChainTek	T-150S	1308010	0 degree ~ 360 degree	N/A	Nov. 18, 2014	N/A	Radiation (05CH03-HY)
Spectrum Analyzer	Rohde & Schwarz	FSV30	101749	10Hz ~ 30GHz	Feb. 10, 2014	Dec. 12, 2014 ~ Dec. 13, 2014	Feb. 09, 2015	Radiation (03CH07-HY)



8 Uncertainty Evaluation

Test Item	Uncertainty
Occupied Channel Bandwidth	± 0.49 %
RF output power, conducted	±0.61 dB
Power density, conducted	±0.60 dB
Radiated emissions	±2.79 dB
Temperature	±0.8 °C
Humidity	±3 %
Time	±0.33 %