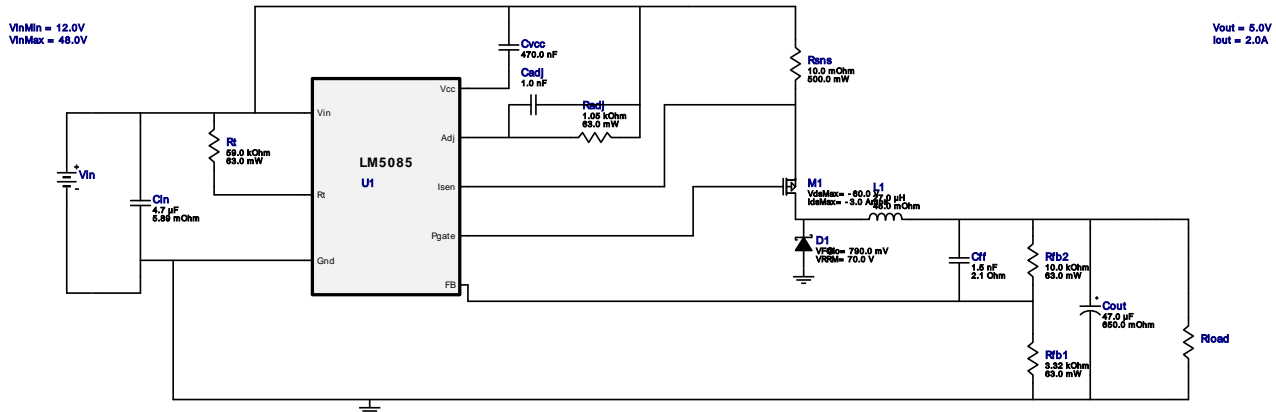
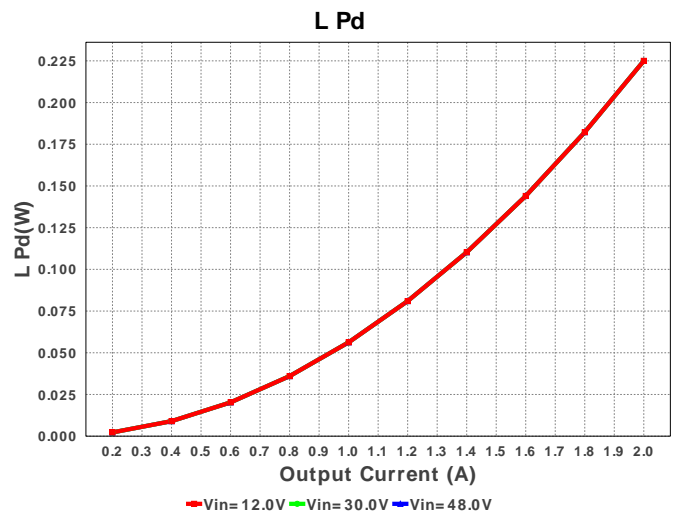
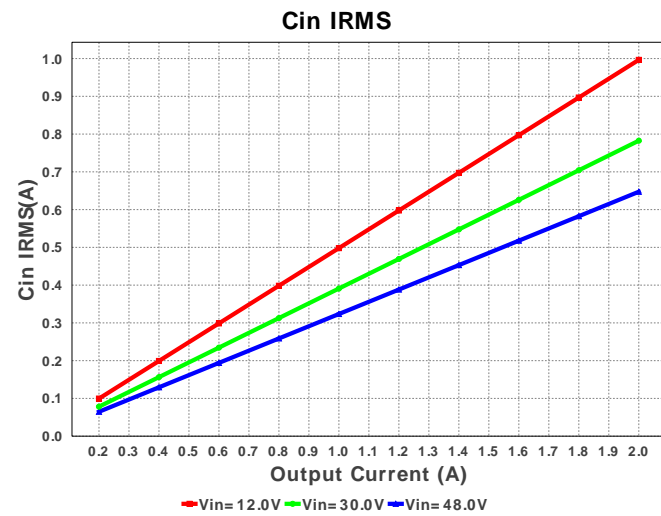
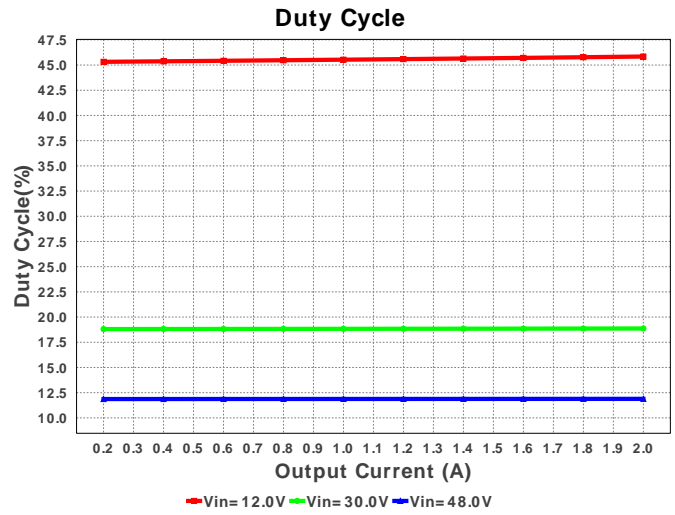
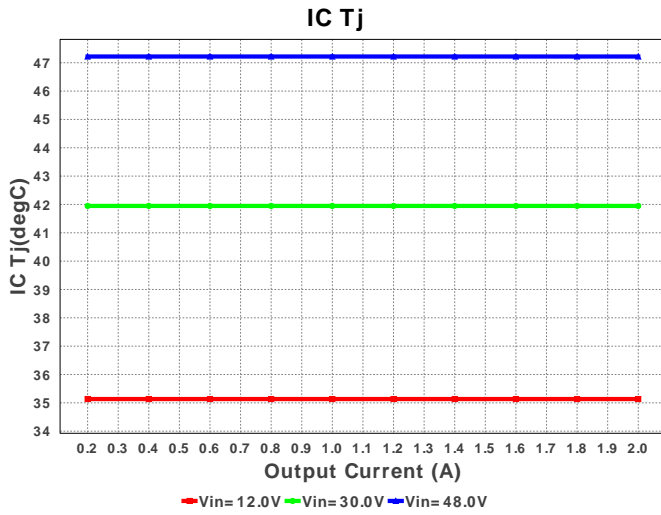

**WEBENCH® Design Report**

 Design : 3791413/8 LM5085MY/NOPB  
 LM5085MY/NOPB 12.0V-48.0V to 5.00V @ 2.0A

**Electrical BOM**

#	Name	Manufacturer	Part Number	Properties	Qty	Price	Footprint
1.	Cadj	Yageo America	CC0805KRX7R9BB102 Series= X7R	Cap= 1.0 nF VDC= 50.0 V IRMS= 0.0 A	1	\$0.01	 0805 7 mm <sup>2</sup>
2.	Cff	MuRata	GRM188R72E152KW07D Series= X7R	Cap= 1.5 nF ESR= 2.1 Ohm VDC= 250.0 V IRMS= 100.0 mA	1	\$0.12	 0603 5 mm <sup>2</sup>
3.	Cin	TDK	C3225X7S2A475M200AB Series= X7R	Cap= 4.7 uF ESR= 5.89 mOhm VDC= 100.0 V IRMS= 6.7739 A	1	\$0.42	 1210 15 mm <sup>2</sup>
4.	Cout	AVX	TPSB476K010R0650 Series= TPS	Cap= 47.0 uF ESR= 650.0 mOhm VDC= 10.0 V IRMS= 325.0 mA	1	\$0.16	 3528-21 17 mm <sup>2</sup>
5.	Cvcc	Taiyo Yuden	EMK212B7474KD-T Series= X7R	Cap= 470.0 nF VDC= 16.0 V IRMS= 0.0 A	1	\$0.02	 0805 7 mm <sup>2</sup>
6.	D1	Diodes Inc.	B370-13-F	VF@Io= 790.0 mV VRRM= 70.0 V	1	\$0.22	 SMC 83 mm <sup>2</sup>
7.	L1	Bourns	SRR1260-270M	L= 27.0 µH DCR= 45.0 mOhm	1	\$0.41	 SRR1260 210 mm <sup>2</sup>
8.	M1	Fairchild Semiconductor	FDC5614P	VdsMax= -60.0 V IdsMax= -3.0 Amps	1	\$0.23	 SOT-23-6 15 mm <sup>2</sup>
9.	Radj	Vishay-Dale	CRCW04021K05FKED Series= CRCW..e3	Res= 1.05 kOhm Power= 63.0 mW Tolerance= 1.0%	1	\$0.01	 0402 3 mm <sup>2</sup>
10.	Rfb1	Vishay-Dale	CRCW04023K32FKED Series= CRCW..e3	Res= 3.32 kOhm Power= 63.0 mW Tolerance= 1.0%	1	\$0.01	 0402 3 mm <sup>2</sup>

#	Name	Manufacturer	Part Number	Properties	Qty	Price	Footprint
11.	Rfb2	Vishay-Dale	CRCW040210K0FKED Series= CRCW..e3	Res= 10.0 kOhm Power= 63.0 mW Tolerance= 1.0%	1	\$0.01	0402 3 mm <sup>2</sup>
12.	Rsns	Stackpole Electronics Inc	CSR1206FK10L0 Series= ?	Res= 10.0 mOhm Power= 500.0 mW Tolerance= 1.0%	1	\$0.11	1206 11 mm <sup>2</sup>
13.	Rt	Vishay-Dale	CRCW040259K0FKED Series= CRCW..e3	Res= 59.0 kOhm Power= 63.0 mW Tolerance= 1.0%	1	\$0.01	0402 3 mm <sup>2</sup>
14.	U1	Texas Instruments	LM5085MY/NOPB	Switcher	1	\$0.85	MUY08A 24 mm <sup>2</sup>

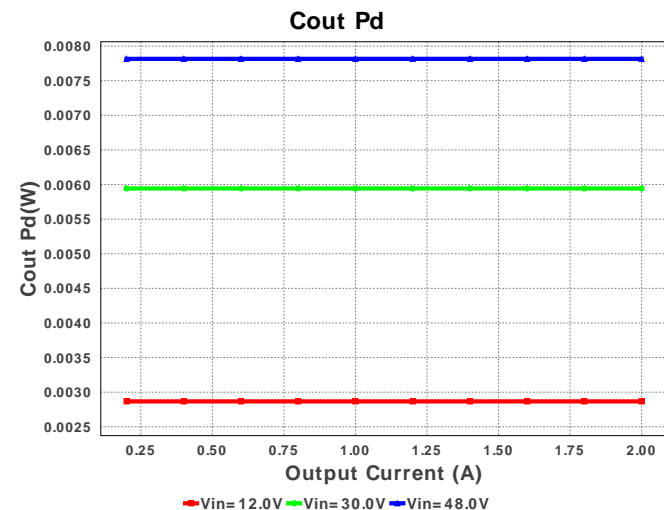
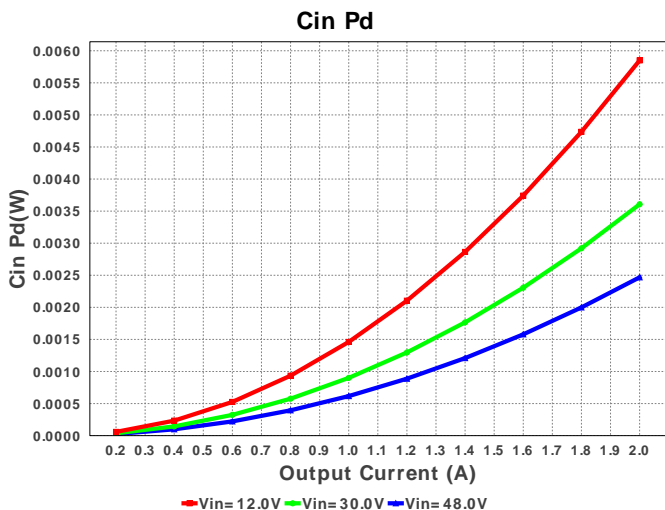
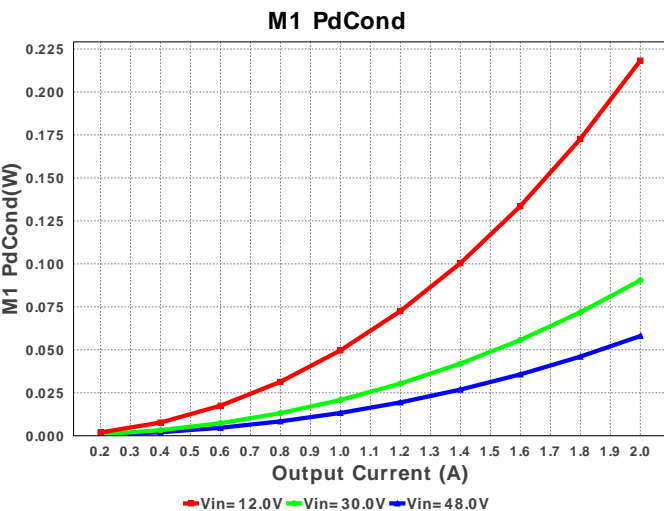
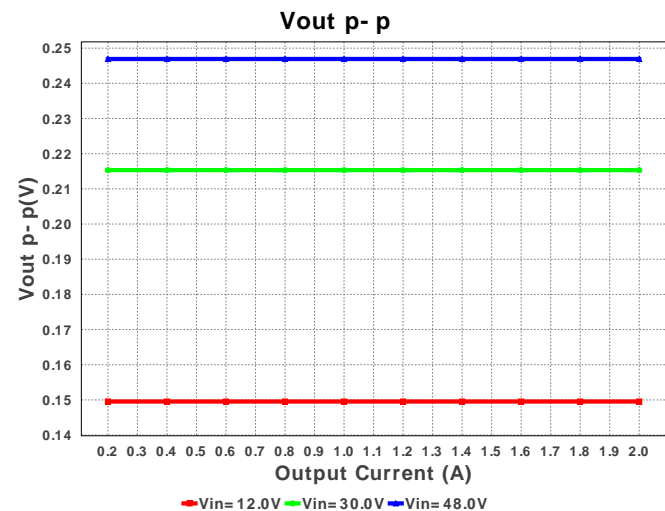
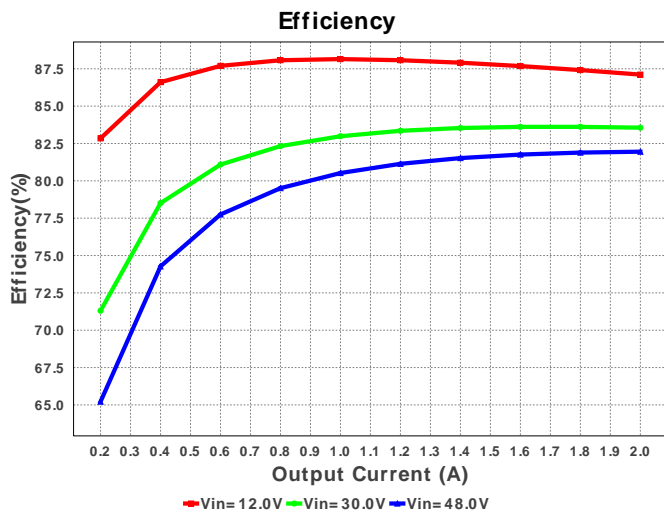
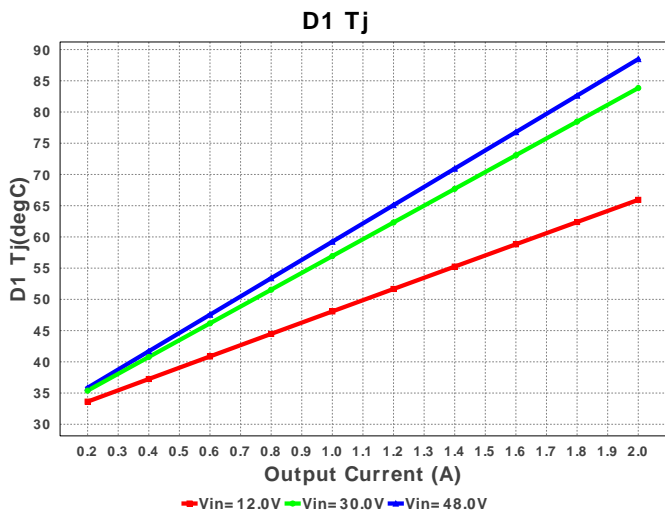

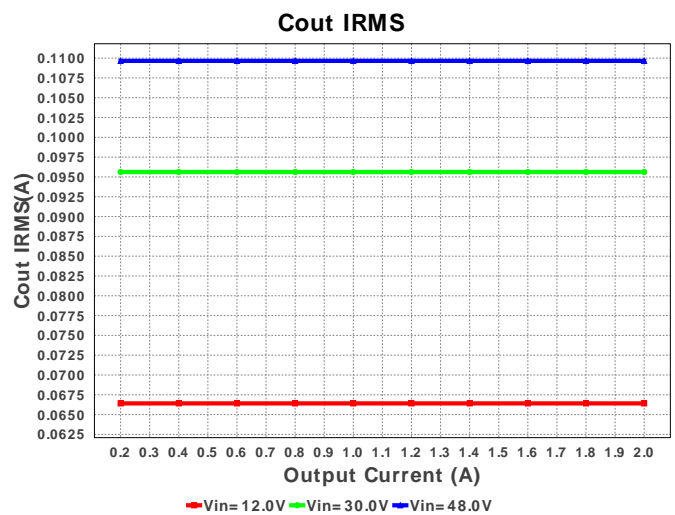
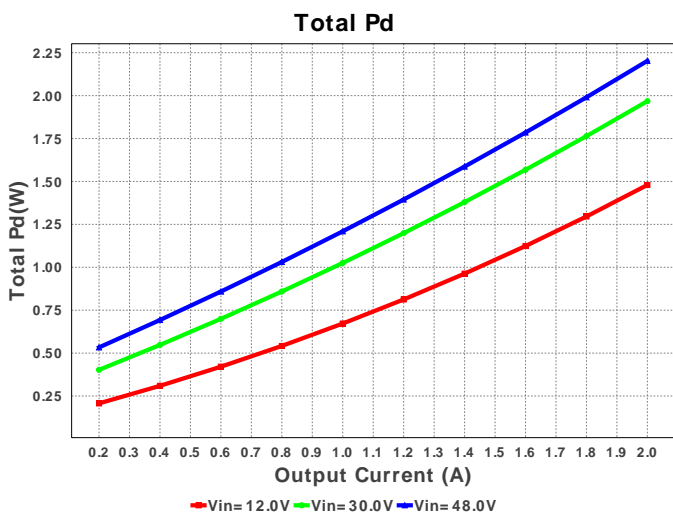
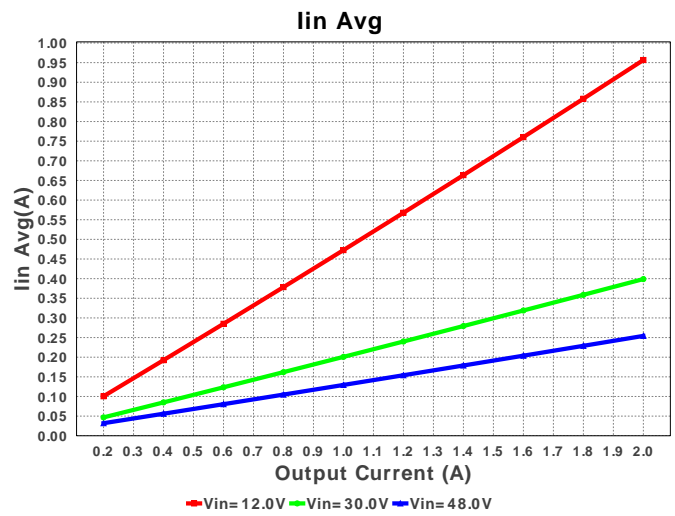
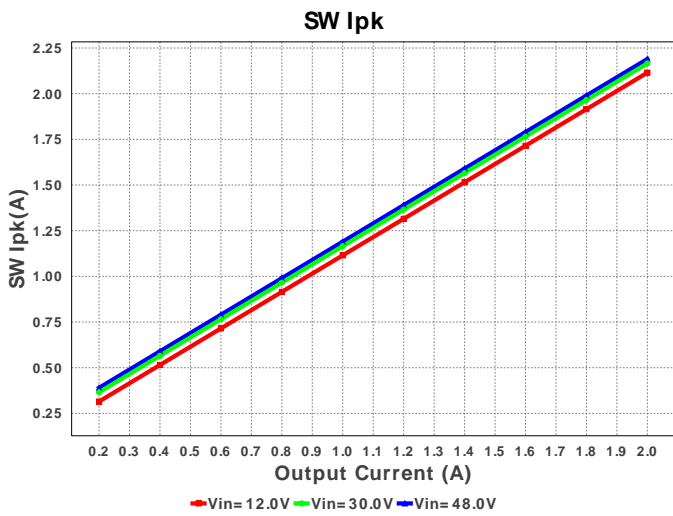
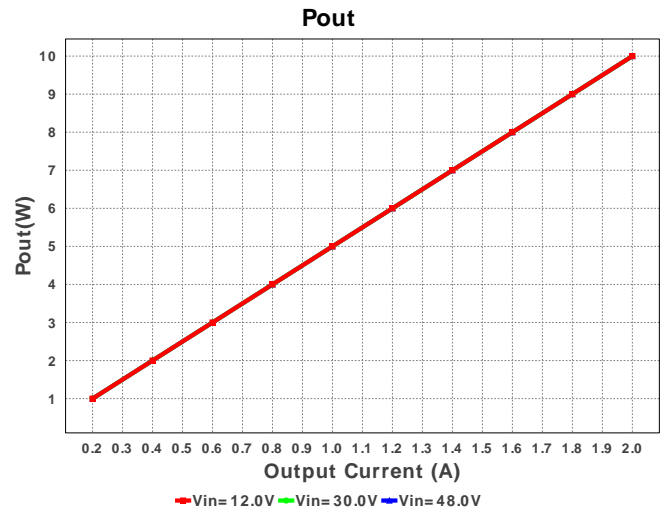
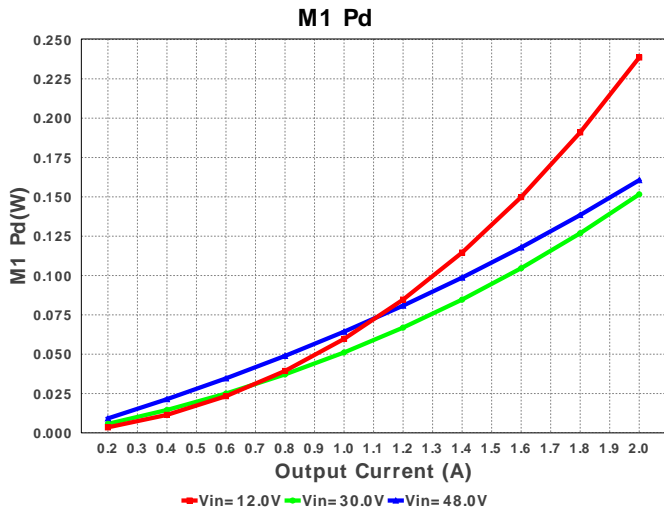



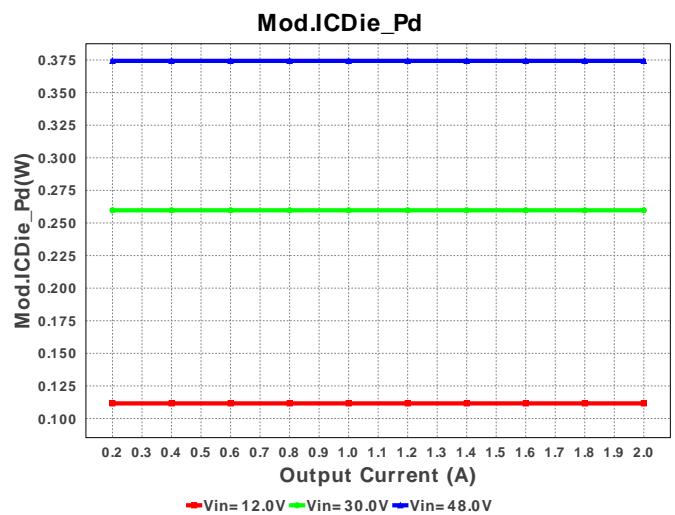
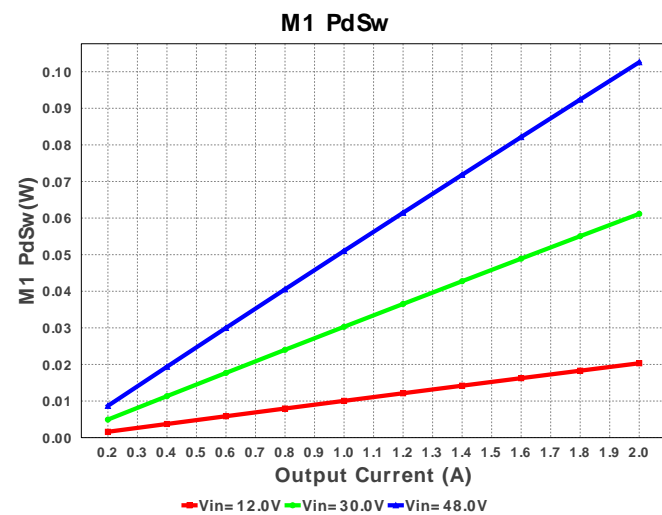
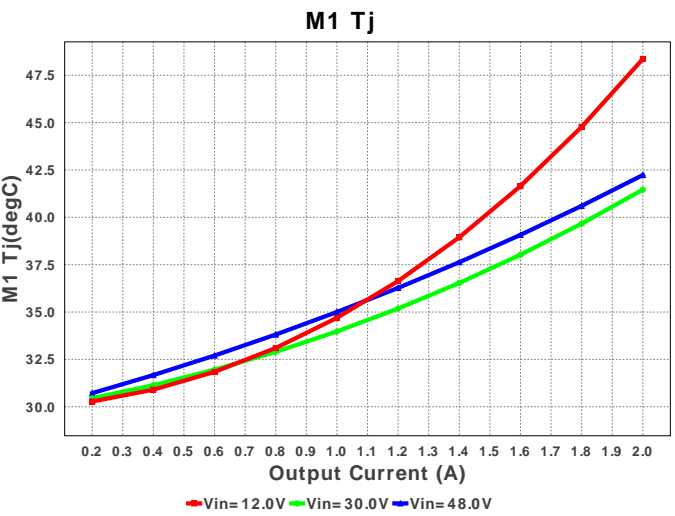
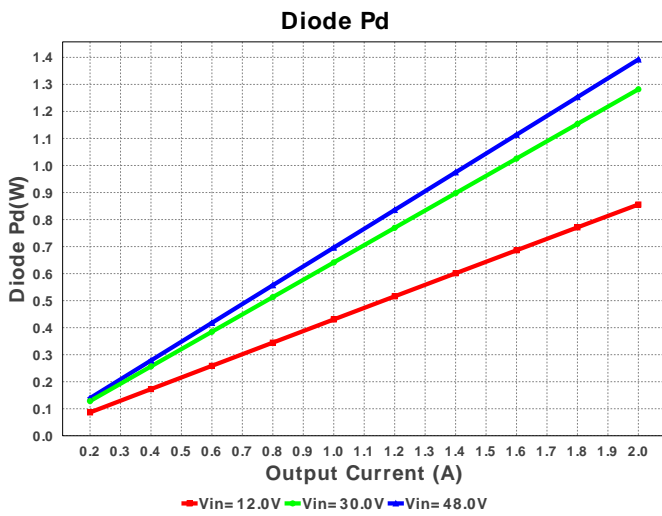
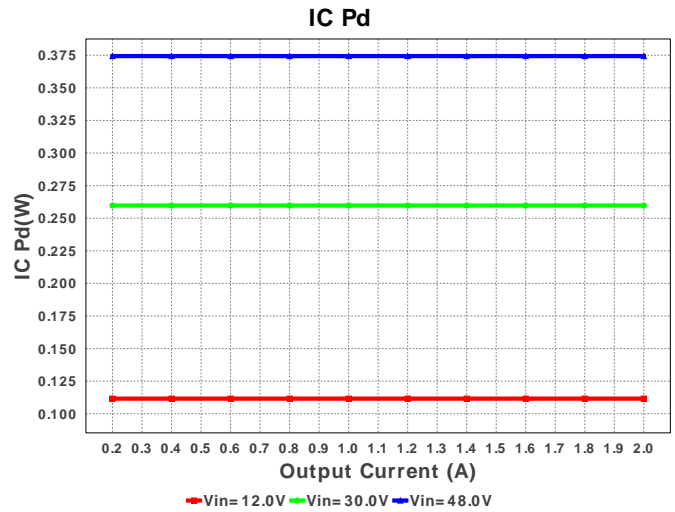
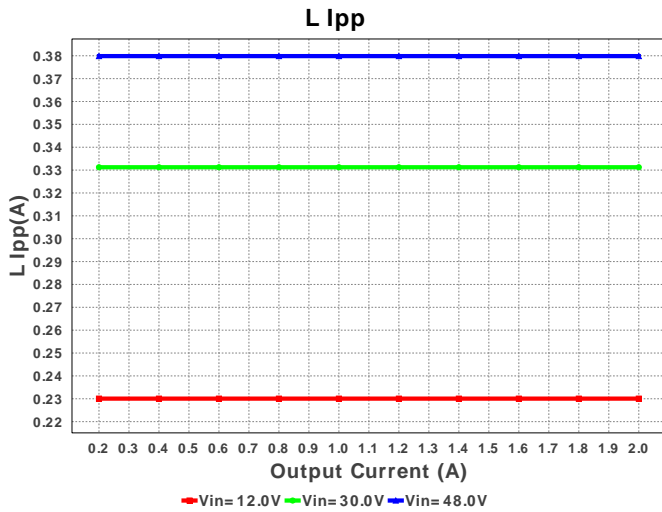

### Operating Values

#	Name	Value	Category	Description
1.	Cin IRMS	647.291 mA	Current	Input capacitor RMS ripple current
2.	Cout IRMS	109.654 mA	Current	Output capacitor RMS ripple current
3.	Iin Avg	254.23 mA	Current	Average input current
4.	L Ipp	379.852 mA	Current	Peak-to-peak inductor ripple current
5.	SW Ipk	2.19 A	Current	Peak switch current
6.	BOM Count	14	General	Total Design BOM count
7.	FootPrint	405.0 mm <sup>2</sup>	General	Total Foot Print Area of BOM components
8.	Frequency	361.048 kHz	General	Switching frequency
9.	IC Tolerance	25.0 mV	General	IC Feedback Tolerance
10.	Pout	10.0 W	General	Total output power
11.	Total BOM	\$2.59	General	Total BOM Cost

#	Name	Value	Category	Description
12.	D1 Tj	88.471 degC	Op_Point	D1 junction temperature
13.	Vout OP	5.0 V	Op_Point	Operational Output Voltage
14.	Duty Cycle	11.888 %	Op_point	Duty cycle
15.	Efficiency	81.948 %	Op_point	Steady state efficiency
16.	IC Tj	47.22 degC	Op_point	IC junction temperature
17.	ICThetaJA	46.0 degC/W	Op_point	IC junction-to-ambient thermal resistance
18.	IOUT_OP	2.0 A	Op_point	Iout operating point
19.	M1 Tj	42.232 degC	Op_point	M1 MOSFET junction temperature
20.	VIN_OP	48.0 V	Op_point	Vin operating point
21.	Vout p-p	246.92 mV	Op_point	Peak-to-peak output ripple voltage
22.	Cin Pd	2.468 mW	Power	Input capacitor power dissipation
23.	Cout Pd	7.816 mW	Power	Output capacitor power dissipation
24.	Diode Pd	1.392 W	Power	Diode power dissipation
25.	IC Pd	374.346 mW	Power	IC power dissipation
26.	L Pd	225.0 mW	Power	Inductor power dissipation
27.	M1 Pd	161.129 mW	Power	M1 MOSFET total power dissipation
28.	M1 PdCond	58.539 mW	Power	M1 MOSFET conduction losses
29.	M1 PdSw	102.59 mW	Power	M1 MOSFET switching losses
30.	Total Pd	2.203 W	Power	Total Power Dissipation

## Design Inputs

#	Name	Value	Description
1.	Iout	2.0 A	Maximum Output Current
2.	Iout1	2.0 Amps	Output Current #1
3.	VinMax	48.0 V	Maximum input voltage
4.	VinMin	12.0 V	Minimum input voltage
5.	Vout	5.0 V	Output Voltage
6.	Vout1	5.0 Volt	Output Voltage #1
7.	base_pn	LM5085	Base Product Number
8.	source	DC	Input Source Type
9.	Ta	30.0 degC	Ambient temperature

## Design Assistance

1. For a Constant On Time device to be stable, we need to provide a ripple at the feedback comparator. There are various methods to implement the ripple. Depending on the circuit complexity vs. the allowable ripple, we have three options to choose from. The simplest option, 'Low Complexity', would require only a high ESR cap at the output. This means that the BOM count will be small, but the output voltage ripple will be quite large. The 'optimal solution' would require a feed-forward cap in parallel with the upper feedback resistor to AC couple the ripple to the feedback node. This increases the BOM count slightly, but now we have more control over the output voltage ripple. If the output voltage requirement is very tight, then the best option is to go for the 'Low Output Ripple' solution. In this option we can go with very low ESR output caps and have very good control over the output voltage ripple

2. **LM5085 Product Folder** : <http://www.ti.com/product/lm5085> : contains the data sheet and other resources.

Texas Instruments' WEBENCH simulation tools attempt to recreate the performance of a substantially equivalent physical implementation of the design. Simulations are created using Texas Instruments' published specifications as well as the published specifications of other device manufacturers. While Texas Instruments does update this information periodically, this information may not be current at the time the simulation is built. Texas Instruments does not warrant the accuracy or completeness of the specifications or any information contained therein. Texas Instruments does not warrant that any designs or recommended parts will meet the specifications you entered, will be suitable for your application or fit for any particular purpose, or will operate as shown in the simulation in a physical implementation. Texas Instruments does not warrant that the designs are production worthy.

**You should completely validate and test your design implementation to confirm the system functionality for your application prior to production.**

Use of Texas Instruments' WEBENCH simulation tools is subject to [Texas Instruments' Site Terms and Conditions of Use](#). Prototype boards based on WEBENCH created designs are provided AS IS without warranty of any kind for evaluation and testing purposes and are subject to the terms of the [Evaluation License Agreement](#).