

mmWave Radar Interface Control Document

Revision 1.11



June 4, 2020

Contents

	Page
Contents	ii
List of Figures	ii
List of Tables	iii
Revision History	v
1 Introduction	1
1.1 Scope	1
1.2 Intended Audience	1
2 TI mmWave Radar Sensor Communications Overview	3
2.1 Communication Link Description	3
2.2 Communication Link configuration	3
2.2.1 SPI	3
2.2.2 Mailbox	3
2.3 Radar Message Structure	5
2.3.1 SYNC	6
2.3.2 MSGHDR	6
2.3.3 MSGDATA	12
2.3.4 CRC	13
3 Message Processing	15
3.1 Communication protocol	15
3.2 Communication Sequence	16
3.2.1 Command/Response Sequence (Host)	16
3.2.2 Flow Diagram (Host) – Command/Response	17
3.2.3 Flow Diagram (Host) – Bootup/ Asynchronous Event	18
3.2.4 SPI Message Sequence – Command/Response	19
4 Radar Interface Messages Descriptions	21
4.1 Summary of all messages and their associated sub-blocks	21
4.2 AWR_ACK_MSG	27

4.3	AWR_NACK_MSG	27
4.4	AWR_ERROR_MSG	28
4.5	AWR_RF_STATIC_CONF_SET_MSG	28
4.6	AWR_RF_STATIC_CONF_GET_MSG	29
4.7	AWR_RF_INIT_MSG	30
4.8	AWR_RF_DYNAMIC_CONF_SET_MSG	30
4.9	AWR_RF_DYNAMIC_CONF_GET_MSG	31
4.10	AWR_RF_FRAME_TRIG_MSG	32
4.11	AWR_RF_ADVANCED_FEATURES_CONF_SET_MSG	33
4.12	AWR_RF_MONITORING_CONF_SET_MSG	33
4.13	AWR_RF_STATUS_GET_MSG	35
4.14	AWR_RF_MONITORING_REPORT_GET_MSG	36
4.15	AWR_RF_MISC_CONF_SET_MSG	36
4.16	AWR_RF_MISC_CONF_GET_MSG	37
4.17	AWR_RF_ASYNC_EVENT_MSG1	37
4.18	AWR_RF_ASYNC_EVENT_MSG2	39
4.19	AWR_DEV_RFPOWERUP_MSG	40
4.20	AWR_DEV_CONF_SET_MSG	41
4.21	AWR_DEV_CONF_GET_MSG	41
4.22	AWR_DEV_FILE_DOWNLOAD_MSG	42
4.23	AWR_DEV_FRAME_CONFIG_APPLY_MSG	43
4.24	AWR_DEV_STATUS_GET_MSG	44
4.25	AWR_DEV_ASYNC_EVENT_MSG	44
5	Radar Functional APIs	46
5.1	Sub block related to AWR_ERROR_MSG	46
5.1.1	Sub block 0x0000 – AWR_RESP_ERROR_SB	46
5.2	Sub blocks related to AWR_RF_STATIC_CONF_SET_MSG	47
5.2.1	Sub block 0x0080 – AWR_CHAN_CONF_SET_SB	47
5.2.2	Sub block 0x0082 – AWR_ADCOUT_CONF_SET_SB	50
5.2.3	Sub block 0x0083 – AWR_LOWPOWERMODE_CONF_SET_SB	51
5.2.4	Sub block 0x0084 – AWR_DYNAMICPOWERSAVE_CONF_SET_SB	51
5.2.5	Sub block 0x0085 – AWR_HIGHSPEEDINTFCLK_CONF_SET_SB	52
5.2.6	Sub block 0x0086 – AWR_RF_DEVICE_CFG_SB	53
5.2.7	Sub block 0x0087 – AWR_RF_RADAR_MISC_CTL_SB	55
5.2.8	Sub block 0x0088 – AWR_CAL_MON_FREQUENCY_LIMITS_SB	56
5.2.9	Sub block 0x0089 – AWR_RF_INIT_CALIBRATION_CONF_SB	57
5.2.10	Sub block 0x008A – AWR_CAL_MON_FREQUENCY_TX_POWER_LIMITS_SB	59
5.2.11	Sub block 0x008B – AWR_CAL_DATA_RESTORE_SB	61
5.2.12	Sub block 0x008C – AWR_PHASE_SHIFTER_CAL_DATA_RESTORE_SB	62
5.2.13	Sub block 0x008D – AWR_APLL_SYNTH_BW_CONTROL_SB	64
5.3	Sub blocks related to AWR_RF_STATIC_CONF_GET_MSG	65

5.3.1	Sub block 0x00A0 – 0x00AA – RESERVED	65
5.3.2	Sub block 0x00AB – AWR_CAL_DATA_SAVE_SB	65
5.3.3	Sub block 0x00AC – AWR_PHASE_SHIFTER_CAL_DATA_SAVE_SB	69
5.4	Sub blocks related to AWR_RF_INIT_MSG	72
5.4.1	Sub block 0x00C0 – AWR_RF_INIT_SB	72
5.5	Sub blocks related to AWR_RF_DYNAMIC_CONF_SET_MSG	72
5.5.1	Sub block 0x0100 – AWR_PROFILE_CONF_SET_SB	72
5.5.2	Sub block 0x0101 – AWR_CHIRP_CONF_SET_SB	82
5.5.3	Sub block 0x0102 – AWR_FRAME_CONF_SET_SB	83
5.5.4	Sub block 0x0103 – AWR_CONT_STREAMING_MODE_CONF_SET_SB	86
5.5.5	Sub block 0x0104 – AWR_CONT_STREAMING_MODE_EN_SB	89
5.5.6	Sub block 0x0105 – AWR_ADVANCED_FRAME_CONF_SB	89
5.5.7	Sub block 0x0106 – AWR_PERCHIRPPHASESHIFT_CONF_SB	99
5.5.8	Sub block 0x0107 – AWR_PROG_FILT_COEFF_RAM_SET_SB	100
5.5.9	Sub block 0x0108 – AWR_PROG_FILT_CONF_SET_SB	101
5.5.10	Sub block 0x0109 – AWR_CALIB_MON_TIME_UNIT_CONF_SB	102
5.5.11	Sub block 0x010A – AWR_RUN_TIME_CALIBRATION_CONF_AND_TRIGGER_SB	103
5.5.12	Sub block 0x010B – AWR_INTER_RX_GAIN_PHASE_CONTROL_SB	107
5.5.13	Sub block 0x010C – AWR_RX_GAIN_TEMPLUT_SET_SB	108
5.5.14	Sub block 0x010D – AWR_TX_GAIN_TEMPLUT_SET_SB	111
5.5.15	Sub block 0x010E – AWR_LOOPBACK_BURST_CONF_SET_SB	114
5.5.16	Sub block 0x010F – AWR_DYN_CHIRP_CONF_SET_SB	120
5.5.17	Sub block 0x0110 – AWR_DYN_PERCHIRP_PHASESHIFTER_CONF_SET_SB	123
5.5.18	Sub block 0x0111 – AWR_DYN_CHIRP_ENABLE_SB	125
5.5.19	Sub block 0x0112 – AWR_INTERCHIRP_BLOCKCONTROLS_SB	126
5.5.20	Sub block 0x0113 – AWR_SUBFRAME_START_CONF_SB	128
5.6	Sub blocks related to AWR_RF_DYNAMIC_CONF_GET_SB	130
5.6.1	Sub block 0x0120 – AWR_PROFILE_CONF_GET_SB	130
5.6.2	Sub block 0x0121 – AWR_CHIRP_CONF_GET_SB	130
5.6.3	Sub block 0x0122 – AWR_FRAME_CONF_GET_SB	130
5.6.4	Sub block 0x0123 – RESERVED	131
5.6.5	Sub block 0x0124 – RESERVED	131
5.6.6	Sub block 0x0125 – AWR_ADV_FRAME_CONF_GET_SB	131
5.6.7	Sub block 0x0126 – RESERVED	131
5.6.8	Sub block 0x0127 – RESERVED	131
5.6.9	Sub block 0x0128 – RESERVED	131
5.6.10	Sub block 0x0129 – RESERVED	131
5.6.11	Sub block 0x012A – RESERVED	131
5.6.12	Sub block 0x012B – RESERVED	131
5.6.13	Sub block 0x012C – AWR_RX_GAIN_TEMPLUT_GET_SB	131
5.6.14	Sub block 0x012D – AWR_TX_GAIN_TEMPLUT_GET_SB	132
5.7	Sub blocks related to AWR_FRAME_TRIG_MSG	132

5.7.1	Sub block 0x0140 – AWR_FRAMESTARTSTOP_CONF_SB	132
5.8	Sub blocks related to AWR_RF_ADVANCED_FEATURES_CONF_SET_MSG . . .	133
5.8.1	Sub block 0x0180 – AWR_BPM_COMMON_CONF_SET_SB	133
5.8.2	Sub block 0x0181 – AWR_BPM_CHIRP_CONF_SET_SB	134
5.8.3	Sub block 0x0182 – AWR_POWER_SAVE_MODE_CONF_SET_SB	135
5.9	Sub blocks related to AWR_RF_STATUS_GET_MSG	136
5.9.1	Sub block 0x0220 – AWR_RF_VERSION_GET_SB	136
5.9.2	Sub block 0x0221 – AWR_RF_CPUFAULT_STATUS_GET_SB	138
5.9.3	Sub block 0x0222 – AWR_RF_ESMFAULT_STATUS_GET_SB	140
5.9.4	Sub block 0x0223 – AWR_RF_DIEID_GET_SB	142
5.9.5	Sub block 0x0224 – AWR_RF_BOOTUPBIST_STATUS_GET_SB	143
5.10	Sub blocks related to AWR_RF_MONITORING_REPORT_GET_MSG	145
5.10.1	Sub block 0x0260 – AWR_RF_DFE_STATISTICS_REPORT_GET_SB	145
5.11	Sub blocks related to AWR_RF_MISC_CONF_SET_MSG	154
5.11.1	Sub block 0x02C0 – RESERVED	154
5.11.2	Sub block 0x02C1 – RESERVED	154
5.11.3	Sub block 0x02C2 – AWR_RF_TEST_SOURCE_CONFIG_SET_SB	154
5.11.4	Sub block 0x02C3 – AWR_RF_TEST_SOURCE_ENABLE_SET_SB	156
5.11.5	Sub block 0x02C4 – 0x02CB RESERVED	156
5.11.6	Sub block 0x02CC – AWR_RF_LDO_BYPASS_SB	156
5.11.7	Sub block 0x02CD – AWR_RF_PALOOBACK_CFG_SB	158
5.11.8	Sub block 0x02CE – AWR_RF_PSLOOPBACK_CFG_SB	159
5.11.9	Sub block 0x02CF – AWR_RF_IFLOOPBACK_CFG_SB	160
5.11.10	Sub block 0x02D0 – AWR_RF_GPADC_CFG_SET_SB	161
5.11.11	Sub block 0x02D1 – RESERVED	164
5.11.12	Sub block 0x02D2 – RESERVED	164
5.11.13	Sub block 0x02D3 – RESERVED	164
5.12	Sub blocks related to AWR_RF_MISC_CONF_GET_MSG	164
5.12.1	Sub block 0x02E0 to 0x2E9 – RESERVED	164
5.12.2	Sub block 0x02EA – AWR_RF_TEMPERATURE_GET_SB	164
5.13	Sub blocks related to AWR_RF_ASYNC_EVENT_MSG1	166
5.13.1	Sub block 0x1000 – RESERVED	166
5.13.2	Sub block 0x1001 – RESERVED	166
5.13.3	Sub block 0x1002 – AWR_AE_RF_CPUFAULT_SB	166
5.13.4	Sub block 0x1003 – AWR_AE_RF_ESMFAULT_SB	167
5.13.5	Sub block 0x1004 – AWR_AE_RF_INITCALIBSTATUS_SB	170
5.13.6	Sub block 0x1005 – RESERVED	172
5.13.7	Sub block 0x1006 – RESERVED	172
5.13.8	Sub block 0x1007 – RESERVED	172
5.13.9	Sub block 0x1008 – RESERVED	172
5.13.10	Sub block 0x1009 – RESERVED	172
5.13.11	Sub block 0x100A – RESERVED	172
5.13.12	Sub block 0x100B – AWR_AE_RF_FRAME_TRIGGER_RDY_SB	172
5.13.13	Sub block 0x100C – AWR_AE_RF_GPADC_RESULT_DATA_SB	172

5.13.14	Sub block 0x100E – RESERVED	174
5.13.15	Sub block 0x100D – RESERVED	174
5.13.16	Sub block 0x100E – RESERVED	174
5.13.17	Sub block 0x100F – AWR_FRAME_END_AE_SB	174
5.13.18	Sub block 0x1010 – AWR_ANALOGFAULT_AE_SB	174
5.13.19	Sub block 0x1011 – AWR_CAL_MON_TIMING_FAIL_REPORT_AE_SB	175
5.13.20	Sub block 0x1012 – AWR_RUN_TIME_CALIB_SUMMARY_REPORT_AE_SB	176
5.13.21	Sub block 0x1013 – AWR_MONITOR_RF_DIG_LATENTFAULT_REPORT_AE_SB	179
5.13.22	Sub block 0x1014 – RESERVED	181
5.13.23	Sub block 0x1015 – AWR_MONITOR_REPORT_HEADER_AE_SB	181
5.13.24	Sub block 0x1016 – AWR_MONITOR_RF_DIG_PERIODIC_REPORT_AE_SB	181
5.13.25	Sub block 0x1017 – AWR_MONITOR_TEMPERATURE_REPORT_AE_SB	182
5.13.26	Sub block 0x1018 – AWR_MONITOR_RX_GAIN_PHASE_REPORT_AE_SB	183
5.13.27	Sub block 0x1019 – AWR_MONITOR_RX_NOISE_FIGURE_REPORT_AE_SB	187
5.13.28	Sub block 0x101A – AWR_MONITOR_RX_IFSTAGE_REPORT_AE_SB	189
5.13.29	Sub block 0x101B – AWR_MONITOR_TX0_POWER_REPORT_AE_SB	191
5.13.30	Sub block 0x101C – AWR_MONITOR_TX1_POWER_REPORT_AE_SB	192
5.13.31	Sub block 0x101D – AWR_MONITOR_TX2_POWER_REPORT_AE_SB	193
5.13.32	Sub block 0x101E – AWR_MONITOR_TX0_BALLBREAK_REPORT_AE_SB	194
5.13.33	Sub block 0x101F – AWR_MONITOR_TX1_BALLBREAK_REPORT_AE_SB	195
5.14	Sub blocks related to AWR_RF_ASYNC_EVENT_MSG2	196
5.14.1	Sub block 0x1020 – AWR_MONITOR_TX2_BALLBREAK_REPORT_AE_SB	196
5.14.2	Sub block 0x1021 – AWR_MONITOR_TX_GAIN_PHASE_MISMATCH_REPORT_AE_SB	197
5.14.3	Sub block 0x1022 – AWR_MONITOR_TX0_BPM_REPORT_AE_SB	199
5.14.4	Sub block 0x1023 – AWR_MONITOR_TX1_BPM_REPORT_AE_SB	200
5.14.5	Sub block 0x1024 – AWR_MONITOR_TX2_BPM_REPORT_AE_SB	202
5.14.6	Sub block 0x1025 – AWR_MONITOR_SYNTHESIZER_FREQUENCY_REPORT_AE_SB	203
5.14.7	Sub block 0x1026 – AWR_MONITOR_EXTERNAL_ANALOG_SIGNALS_REPORT_AE_SB	204
5.14.8	Sub block 0x1027 – AWR_MONITOR_TX0_INTERNAL_ANALOG_SIGNALS_REPORT_AE_SB	205
5.14.9	Sub block 0x1028 – AWR_MONITOR_TX1_INTERNAL_ANALOG_SIGNALS_REPORT_AE_SB	206

5.14.10	Sub block 0x1029 – AWR_MONITOR_TX2_INTERNAL_ANALOG_SIGNALS_REPORT_AE_SB	208
5.14.11	Sub block 0x102A – AWR_MONITOR_RX_INTERNAL_ANALOG_SIGNALS_REPORT_AE_SB	209
5.14.12	Sub block 0x102B – AWR_MONITOR_PMCLKLO_INTERNAL_ANALOG_SIGNALS_REPORT_AE_SB	210
5.14.13	Sub block 0x102C – AWR_MONITOR_GPADC_INTERNAL_ANALOG_SIGNALS_REPORT_AE_SB	211
5.14.14	Sub block 0x102D – AWR_MONITOR_PLL_CONTROL_VOLTAGE_REPORT_AE_SB	212
5.14.15	Sub block 0x102E – AWR_MONITOR_DUAL_CLOCK_COMP_REPORT_AE_SB	213
5.14.16	Sub block 0x1031 – AWR_MONITOR_RX_MIXER_IN_POWER_REPORT_AE_SB	215
5.14.17	Sub block 0x1033 – AWR_MONITOR_SYNTHESIZER_FREQUENCY_NONLIVE_REPORT_AE_SB	216
5.15	Sub blocks related to AWR_DEV_RFPOWERUP_MSG	218
5.15.1	Sub block 0x4000 – AWR_DEV_RFPOWERUP_SB	218
5.16	Sub blocks related to AWR_DEV_CONF_SET_MSG	218
5.16.1	Sub block 0x4040 – AWR_DEV_MCUCLOCK_CONF_SET_SB	218
5.16.2	Sub block 0x4041 – AWR_DEV_RX_DATA_FORMAT_CONF_SET_SB	219
5.16.3	Sub block 0x4042 – AWR_DEV_RX_DATA_PATH_CONF_SET_SB	221
5.16.4	Sub block 0x4043 – AWR_DEV_RX_DATA_PATH_LANEEN_SET_SB	224
5.16.5	Sub block 0x4044 – AWR_DEV_RX_DATA_PATH_CLK_SET_SB	225
5.16.6	Sub block 0x4045 – AWR_DEV_LVDS_CFG_SET_SB	226
5.16.7	Sub block 0x4046 – AWR_DEV_RX_CONTSTREAMING_MODE_CONF_SET_SB	228
5.16.8	Sub block 0x4047 – AWR_DEV_CSI2_CFG_SET_SB	229
5.16.9	Sub block 0x4048 – AWR_DEV_PMICCLOCK_CONF_SET_SB	231
5.16.10	Sub block 0x4049 – AWR_MSS_PERIODICTESTS_CONF_SB	235
5.16.11	Sub block 0x404A – AWR_MSS_LATENTFAULT_TEST_CONF_SB	236
5.16.12	Sub block 0x404B – AWR_DEV_TESTPATTERN_GEN_SET_SB	238
5.16.13	Sub block 0x404C – AWR_DEV_CONFIGURATION_SET_SB	241
5.17	Sub blocks related to AWR_DEV_CONF_GET_MSG	242
5.17.1	Sub block 0x4060 – AWR_DEV_MCUCLOCK_GET_SB	242
5.17.2	Sub block 0x4061 – AWR_DEV_RX_DATA_FORMAT_CONF_GET_SB	242
5.17.3	Sub block 0x4062 – AWR_DEV_RX_DATA_PATH_CONF_GET_SB	242
5.17.4	Sub block 0x4063 – AWR_DEV_RX_DATA_PATH_LANEEN_GET_SB	243
5.17.5	Sub block 0x4064 – AWR_DEV_RX_DATA_PATH_CLK_GET_SB	243
5.17.6	Sub block 0x4065 – AWR_DEV_LVDS_CFG_GET_SB	243
5.17.7	Sub block 0x4066 – AWR_DEV_RX_CONTSTREAMING_MODE_CONF_GET_SB	243
5.17.8	Sub block 0x4067 – AWR_DEV_CSI2_CFG_GET_SB	244
5.17.9	Sub block 0x4068 – AWR_DEV_PMICCLOCK_CONF_GET_SB	244

5.17.10	Sub block 0x4069 – AWR_MSS_LATENTFAULT_TEST_CONF_GET_SB	244
5.17.11	Sub block 0x406A – AWR_MSS_PERIODICTESTS_CONF_GET_SB	245
5.17.12	Sub block 0x406B – AWR_DEV_TESTPATTERN_GEN_GET_SB	245
5.18	Sub blocks related to AWR_DEV_FILE_DOWNLOAD_MSG	245
5.18.1	Sub block 0x4080 – AWR_DEV_FILE_DOWNLOAD_SB	245
5.19	Sub blocks related to AWR_DEV_FRAME_CONFIG_APPLY_MSG	246
5.19.1	Sub block 0x40C0 – AWR_DEV_FRAME_CONFIG_APPLY_SB	246
5.19.2	Sub block 0x40C1 – AWR_DEV_ADV_FRAME_CONFIG_APPLY_SB	247
5.20	Sub blocks related to AWR_DEV_STATUS_GET_MSG	249
5.20.1	Sub block 0x40E0 – AWR_MSSVERSION_GET_SB	249
5.20.2	Sub block 0x40E1 – AWR_MSSCPUFAULT_STATUS_GET_SB	250
5.20.3	Sub block 0x40E2 – AWR_MSSSESMFAULT_STATUS_GET_SB	252
5.21	Sub blocks related to AWR_DEV_ASYNC_EVENT_MSG	255
5.21.1	Sub block 0x5000 – AWR_AE_DEV_MSSPOWERUPDONE_SB	255
5.21.2	Sub block 0x5001 – AWR_AE_DEV_RFPOWERUPDONE_SB	257
5.21.3	Sub block 0x5002 – AWR_AE_MSS_CPUFAULT_SB	259
5.21.4	Sub block 0x5003 – AWR_AE_MSS_ESMFAULT_STATUS_SB	260
5.21.5	Sub block 0x5004 – RESERVED	263
5.21.6	Sub block 0x5005 – AWR_AE_MSS_BOOTERRORSTATUS_SB	263
5.21.7	Sub block 0x5006 – AWR_AE_MSS_LATENTFAULT_TESTREPORT_SB	265
5.21.8	Sub block 0x5007 – AWR_AE_MSS_PERIODICTEST_STATUS_SB	267
5.21.9	Sub block 0x5008 – AWR_AE_MSS_RFERROR_STATUS_SB	267
5.21.10	Sub block 0x5009 – AWR_AE_MSS_VMON_ERRORSTATUS_SB	268
5.21.11	Sub block 0x500A – AWR_AE_MSS_ADC_DATA_SB	269
5.21.12	Sub block 0x500B – RESERVED	269
6	API Programming Sequence	270
6.1	Single device mode	270
6.2	Cascaded device mode	272
6.3	Continuous streaming mode (in single device case)	274
6.4	Continuous streaming (CW) mode (in cascaded device case)	275
7	API Error Codes	278
7.1	Error codes for boot on SPI	288
8	Radar Monitoring APIs	291
8.1	Common Configurations and Reports	291
8.1.1	Sub block 0x01C0 – AWR_MONITOR_RF_DIG_LATENTFAULT_CONF_SB	291
8.1.2	Sub block 0x01C1 – AWR_MONITOR_RF_DIG_PERIODIC_CONF_SB	293
8.1.3	Sub block 0x01C2 – AWR_MONITOR_ANALOG_ENABLES_CONF_SB	294
8.2	Temperature Monitor	296
8.2.1	Sub block 0x01C3 – AWR_MONITOR_TEMPERATURE_CONF_SB	296
8.3	RX Gain and Phase Monitor	298

8.3.1	Sub block 0x01C4 – AWR_MONITOR_RX_GAIN_PHASE_CONF_SB	. 298
8.4	RX Noise Monitor	. 301
8.4.1	Sub block 0x01C5 – AWR_MONITOR_RX_NOISE_FIGURE_CONF_SB	301
8.5	RX IF Stage Monitor	. 303
8.5.1	Sub block 0x01C6 – AWR_MONITOR_RX_IFSTAGE_CONF_SB	. . . 303
8.6	TX Power Monitor	. . . 304
8.6.1	Sub block 0x01C7 – AWR_MONITOR_TX0_POWER_CONF_SB 304
8.6.2	Sub block 0x01C8 – AWR_MONITOR_TX1_POWER_CONF_SB 306
8.6.3	Sub block 0x01C9 – AWR_MONITOR_TX2_POWER_CONF_SB 307
8.7	TX Ball Break Monitor 309
8.7.1	Sub block 0x01CA – AWR_MONITOR_TX0_BALLBREAK_CONF_SB	. 309
8.7.2	Sub block 0x01CB – AWR_MONITOR_TX1_BALLBREAK_CONF_SB	. 310
8.7.3	Sub block 0x01CC – AWR_MONITOR_TX2_BALLBREAK_CONF_SB	. 311
8.8	TX Gain and Phase Mismatch Monitoring 312
8.8.1	Sub block 0x01CD – AWR_MONITOR_TX_GAIN_PHASE_MISMATCH_CONF_SB 312
8.9	TX BPM Phase Monitor 315
8.9.1	Sub block 0x01CE – AWR_MONITOR_TX0_BPM_CONF_SB 315
8.9.2	Sub block 0x01CF – AWR_MONITOR_TX1_BPM_CONF_SB 317
8.9.3	Sub block 0x01D0 – AWR_MONITOR_TX2_BPM_CONF_SB 319
8.10	Synthesizer Frequency Monitoring 321
8.10.1	Sub block 0x01D1 – AWR_MONITOR_SYNTHESIZER_FREQUENCY_CONF_SB 321
8.11	External Analog Signals Monitor 323
8.11.1	Sub block 0x01D2 – AWR_MONITORING_EXTERNAL_ANALOG_SIGNALS_CONF_SB 323
8.12	Internal Analog Signals Monitor 326
8.12.1	Sub block 0x01D3 – AWR_MONITOR_TX0_INTERNAL_ANALOG_SIGNALS_CONF_SB 327
8.12.2	Sub block 0x01D4 – AWR_MONITOR_TX1_INTERNAL_ANALOG_SIGNALS_CONF_SB 328
8.12.3	Sub block 0x01D5 – AWR_MONITOR_TX2_INTERNAL_ANALOG_SIGNALS_CONF_SB 329
8.12.4	Sub block 0x01D6 – AWR_MONITOR_RX_INTERNAL_ANALOG_SIGNALS_CONF_SB 330
8.12.5	Sub block 0x01D7 – AWR_MONITOR_PMCLKLO_INTERNAL_ANALOG_SIGNALS_CONF_SB 330
8.12.6	Sub block 0x01D8 – AWR_MONITOR_GPADC_INTERNAL_ANALOG_SIGNALS_CONF_SB 331
8.13	PLL Control Voltage Monitor 332
8.13.1	Sub block 0x01D9 – AWR_MONITOR_PLL_CONTROL_VOLTAGE_SIGNALS_CONF_SB 332
8.14	Dual Clock Comparator Based Clock Frequency Monitor 333

8.14.1	Sub block 0x01DA – AWR_MONITOR_DUAL_CLOCK_COMP_CONF_SB	334
8.15	RX Saturation Detection Monitor	335
8.15.1	Sub block 0x01DB – AWR_MONITOR_RX_SATURATION_DETECTOR_CONF_SB	335
8.15.2	Sub block 0x01DC – AWR_MONITOR_SIG_IMG_MONITOR_CONF_SB	337
8.16	RX mixer input power monitor	339
8.16.1	Sub block 0x01DD – AWR_MONITOR_RX_MIXER_IN_POWER_CONF_SB	339
8.17	Sub block 0x01DE – RESERVED	341
8.18	Analog Fault injection	341
8.18.1	Sub block 0x01DF – AWR_ANALOG_FAULT_INJECTION_CONF_SB	341
9	Unsupported Features/APIs and Debug APIs	348
9.1	Unsupported Features/APIs and Debug APIs	348
10	Chirp Parameters (CP) and Chirp Quality (CQ) data	349
10.1	Chirp Parameters data	349
10.2	Chirp Quality data	350
10.2.1	CQ1	352
10.2.2	CQ2	355
11	Chirp, Burst and Frame timings	358
11.1	Chirp Cycle Time	358
11.2	Minimum Inter Burst Time	359
11.3	Minimum Inter Sub-frame or Frame Time	360
12	Calibration and monitoring durations	361
12.1	Boot time calibration durations	361
12.2	Run time calibration durations	361
12.3	Monitoring duration	362
12.4	Software overheads	364
12.4.1	Note on idle time for clearing the watchdog (WDT)	364
12.5	Sample Application	369

List of Figures

2.1	AWR12xx, AWR22xx Software Architecture	4
2.2	xWR16xx, xWR18xx and IWR68xx Software Architecture	5
2.3	Radar Message Structure	5
2.4	Message Header Format	6
2.5	OPCODE Format	7
2.6	MSGLEN Format	10
2.7	FLAGS Format	10
2.8	NSBC Format	11
2.9	Message Sub block structure	13
3.1	Flow Diagram (API)	17
3.2	Flow Diagram (Asynchronous Events)	18
3.3	SPI Message Sequence	19
5.1	Frame trigger delay in case of external hardware trigger	86
5.2	Frame trigger delay in case of external hardware trigger	98
5.3	Dynamic chirp configuration use case timing diagram	126
5.4	Lane formats and the order of receiving the data from the lanes	228
10.1	Chirp parameter information fields	349
10.2	Chirp parameter information from DSS registers	350
10.3	CQ data start address configuration in single chirp use case	351
10.4	CQ data start address configuration in multi chirp use case	352
10.5	Time slices during RX signal and image band monitor and saturation monitor	353
10.6	CQ1 data format in memory in 16-bit mode	354
10.7	CQ1 data format in memory in 12-bit mode	355
10.8	CQ1 data format in memory in 14-bit mode	355
10.9	CQ2 data format in memory in 16-bit mode	356
10.10	CQ2 data format in memory in 12-bit mode	357
10.11	CQ2 data format in memory in 14-bit mode	357
12.1	Watchdog idle time calculation	365

List of Tables

1.1	TI CMOS mmWave radar devices	1
2.1	Possible SYNC values and their usage	6
2.3	MSGLEN field descriptions	10
2.4	FLAGS field description	10
2.5	NSBC field description	12
2.6	Checksum computation example	12
2.7	CRC types and their polynomials	13
4.1	Summary of all Radar messages and their associated sub blocks	21
5.1	AWR_RESP_ERROR_SB contents	46
5.2	AWR_CHAN_CONF_SET_SB contents	47
5.3	AWR_ADCOUT_CONF_SB contents	50
5.4	AWR_LOWPOWERMODE_CONF_SET_SB contents	51
5.5	AWR_DYNAMICPOWERSAVE_CONF_SET_SB contents	52
5.6	AWR_HIGHSPEEDINTFCLK_CONF_SET_SB contents	53
5.7	AWR_RF_DEVICE_CFG_SB contents	54
5.8	AWR_RF_MISC_CTL_SB contents	56
5.9	AWR_CAL_MON_FREQUENCY_LIMITS_SB contents	56
5.10	AWR_RF_INIT_CALIBRATION_CONF_SB contents	58
5.11	AWR_CAL_MON_FREQUENCY_TX_POWER_LIMITS_SB contents	59
5.12	AWR_CAL_DATA_RESTORE_SB contents	61
5.13	AWR_PHASE_SHIFTER_CAL_DATA_RESTORE_SB contents	62
5.14	Typical APLL and Synth BW settings	64
5.15	AWR_APLL_SYNTN_BW_CONTROL_SB contents	64
5.16	AWR_CAL_DATA_SAVE_SB contents	65
5.17	AWR_CAL_DATA_SAVE_SB response packet contents	65
5.18	AWR_CAL_DATA contents	66
5.19	AWR_CAL_DATA contents	67
5.20	AWR_PHASE_SHIFTER_CAL_DATA_SAVE_SB contents	69
5.21	AWR_PHASE_SHIFTER_CAL_DATA_SAVE_SB response packet contents	70
5.22	AWR_RF_INIT_SB contents	72
5.23	AWR_PROFILE_CONF_SB contents	73
5.24	Note on maximum sampling rate	81
5.25	AWR_CHIRP_CONF_SET_SB contents	82

5.26	AWR_FRAME_CONF_SET_SB contents	83
5.27	AWR_CONT_STREAMING_MODE_CONF_SET_SB contents	86
5.28	AWR_CONT_STREAMING_MODE_EN_SB contents	89
5.29	AWR_ADVANCED_FRAME_CONF_SB contents	90
5.30	AWR_PERCHIRPPHASESHIFT_CONF_SB contents	99
5.31	AWR_PROG_FILT_COEFF_RAM_SET_SB contents	100
5.32	AWR_PROG_FILT_CONF_SET_SB contents	101
5.33	AWR_CALIB_MON_TIME_UNIT_CONF_SB contents	102
5.34	AWR_RUN_TIME_CALIBRATION_CONF_AND_TRIGGER_SB contents	103
5.35	AWR_INTER_RX_GAIN_PHASE_CONTROL_SB contents	108
5.36	AWR_RX_GAIN_TEMPLUT_SET_SB contents	108
5.37	AWR_TX_GAIN_TEMPLUT_SET_SB contents	111
5.38	AWR_LOOPBACK_BURST_CONF_SET_SB contents	115
5.39	AWR_DYN_CHIRP_CONF_SET_SB contents	120
5.40	AWR_DYN_PERCHIRP_PHASESHIFTER_CONF_SB contents	124
5.41	AWR_DYN_CHIRP_ENABLE_SB contents	125
5.42	AWR_INTERCHIRP_BLOCKCONTROLS_SB contents	126
5.43	AWR_SUBFRAME_START_CONF_SB contents	129
5.44	AWR_PROFILE_CONF_GET_SB contents	130
5.45	AWR_CHIRP_CONF_GET_SB contents	130
5.46	AWR_FRAME_CONF_GET_SB contents	131
5.47	AWR_ADV_FRAME_CONF_GET_SB contents	131
5.48	AWR_RX_GAIN_TEMPLUT_GET_SB contents	132
5.49	AWR_TX_GAIN_TEMPLUT_GET_SB contents	132
5.50	AWR_FRAMESTARTSTOP_CONF_SB contents	132
5.51	AWR_BPM_COMMON_CONF_SET_SB contents	133
5.52	AWR_BPM_CHIRP_CONF_SET_SB contents	134
5.53	AWR_POWER_SAVE_MODE_CONF_SET_SB contents	135
5.54	AWR_RF_VERSION_GET_SB contents	136
5.55	AWR_RF_VERSION_SB response contents	137
5.56	AWR_RF_CPUFAULT_STATUS_GET_SB response contents	138
5.57	AWR_RF_CPUFAULT_STATUS_GET_SB response contents	138
5.58	AWR_RF_ESMFAULT_STATUS_GET_SB response contents	140
5.59	AWR_RF_ESMFAULT_STATUS_SB response contents	140
5.60	AWR_RF_DIEID_GET_SB response contents	143
5.61	AWR_RF_DIEID_STATUS_SB response contents	143
5.62	AWR_RF_BOOTUPBIST_STATUS_GET_SB response contents	143
5.63	AWR_RF_BOOTUPBIST_STATUS_DATA_SB response contents	144
5.64	AWR_RF_DFE_STATISTICS_REPORT_GET_SB response contents	145
5.65	AWR_RF_DFE_STATISTICS_REPORT_SB response contents	145
5.66	AWR_RF_TEST_SOURCE_CONFIG_SET_SB contents	154
5.67	AWR_RF_TEST_SOURCE_ENABLE_SET_SB contents	156
5.68	AWR_RF_LDO_BYPASS_SB contents	157
5.69	AWR_RF_PALOOPBACK_CFG_SB contents	158

5.70	AWR_RF_PSLOOPBACK_CFG_SB contents	159
5.71	AWR_RF_IFLOOPBACK_CFG_SB contents	161
5.72	AWR_RF_GPADC_CFG_SET_SB contents	162
5.73	AWR_RF_TEMPERATURE_GET_SB contents	165
5.74	AWR_RF_TEMPERATURE_DATA_SB contents	165
5.75	AWR_AE_RF_CPUFAULT_SB response contents	166
5.76	AWR_AE_RF_ESMFAULT_STATUS_SB response contents	168
5.77	AWR_AE_RF_INITCALIBSTATUS_SB response contents	170
5.78	AWR_AE_RF_FRAME_TRIGGER_RDY_SB response contents	172
5.79	AWR_AE_RF_GPADC_RESULT_DATA_SB response contents	172
5.80	AWR_FRAME_END_AE_SB response contents	174
5.81	AWR_ANALOGFAULT_AE_SB response contents	175
5.82	AWR_CAL_MON_TIMING_FAIL_REPORT_AE_SB response contents	175
5.83	AWR_RUN_TIME_CALIB_SYMMARY_REPORT_AE_SB response contents	177
5.84	AWR_MONITOR_RF_DIG_LATENTFAULT_REPORT_AE_SB response contents	179
5.85	AWR_MONITORING_REPORT_HEADER_AE_SB response contents	181
5.86	AWR_MONITOR_RF_DIG_PERIODIC_REPORT_AE_SB contents	181
5.87	AWR_MONITORING_TEMPERATURE_REPORT_AE_SB contents	182
5.88	AWR_MONITOR_RX_GAIN_PHASE_REPORT_AE_SB contents	183
5.89	AWR_MONITOR_RX_NOISE_FIGURE_REPORT_AE_SB contents	188
5.90	AWR_MONITOR_RX_IFSTAGE_REPORT_AE_SB contents	189
5.91	AWR_MONITOR_TX0_POWER_REPORT_AE_SB contents	191
5.92	AWR_MONITOR_TX1_POWER_REPORT_AE_SB contents	193
5.93	AWR_MONITOR_TX2_POWER_REPORT_AE_SB contents	194
5.94	AWR_MONITOR_TX0_BALLBREAK_REPORT_AE_SB contents	195
5.95	AWR_MONITOR_TX1_BALLBREAK_REPORT_AE_SB contents	195
5.96	AWR_MONITOR_TX2_BALLBREAK_REPORT_AE_SB contents	196
5.97	AWR_MONITOR_TX_GAIN_PHASE_REPORT_AE_SB contents	197
5.98	AWR_MONITOR_TX0_BPM_REPORT_AE_SB contents	199
5.99	AWR_MONITOR_TX1_BPM_REPORT_AE_SB contents	200
5.100	AWR_MONITOR_TX2_BPM_REPORT_AE_SB contents	202
5.101	AWR_MONITOR_SYNTH_FREQUENCY_REPORT_AE_SB contents	203
5.102	AWR_MONITOR_EXTERNAL_ANALOG_SIGNALS_REPORT_AE_SB contents	204
5.103	AWR_MONITOR_TX0_INTERNAL_ANALOG_SIGNALS_REPORT_AE_SB con- tents	206
5.104	AWR_MONITOR_TX1_INTERNAL_ANALOG_SIGNALS_REPORT_AE_SB con- tents	207
5.105	AWR_MONITOR_TX2_INTERNAL_ANALOG_SIGNALS_REPORT_AE_SB con- tents	208
5.106	AWR_MONITOR_RX_INTERNAL_ANALOG_SIGNALS_REPORT_AE_SB contents	209
5.107	AWR_MONITOR_PM_CLK_LO_INTERNAL_ANALOG_SIGNALS_REPORT_AE_ SB contents	210
5.108	AWR_MONITOR_GPADC_INTERNAL_ANALOG_SIGNALS_REPORT_AE_SB con- tents	211

5.109AWR_MONITOR_PLL_CONTROL_VOLTAGE_REPORT_AE_SB contents	212
5.110AWR_MONITOR_DUAL_CLOCK_COMP_REPORT_AE_SB contents	214
5.111AWR_MONITOR_RX_MIXER_IN_POWER_REPORT_AE_SB contents	215
5.112AWR_MONITOR_SYNTHESIZER_FREQUENCY_NONLIVE_REPORT_AE_SB con- tents	216
5.113AWR_DEV_POWERUP_SB contents	218
5.114AWR_DEV_MCUCLOCK_CONF_SET_SB contents	218
5.115AWR_DEV_RX_DATA_FORMAT_CONF_SB contents	219
5.116AWR_DEV_RX_DATA_PATH_CONF_SB contents	221
5.117AWR_DEV_RX_DATA_PATH_LANEEN_SET_SB contents	224
5.118AWR_DEV_RX_DATA_PATH_CLK_SET_SB contents	225
5.119AWR_DEV_LVDS_CFG_SET_SB contents	226
5.120AWR_DEV_RX_CONTSTREAMING_MODE_CFG_SET_SB contents	229
5.121AWR_DEV_CSI2_CFG_SET_SB contents	229
5.122AWR_DEV_PMICCLOCK_CONF_SET_SB contents	231
5.123PMIC clock frequency across chirps in chirp-to-chirp staircase mode in an exam- ple when PMIC clock varies from 2 MHz to 2.5 MHz in 32 chirps	234
5.124AWR_MSS_PERIODICTESTS_CONF_SB contents	235
5.125AWR_MSS_LATENTFAULT_TEST_CONF_SB contents	236
5.126AWR_DEV_TESTPATTERN_GEN_SET_SB contents	239
5.127AWR_DEV_CONFIGURATION_SET_SB contents	241
5.128AWR_DEV_MCUCLOCK_GET_SB contents	242
5.129AWR_DEV_RX_DATA_FORMAT_CONF_GET_SB contents	242
5.130AWR_DEV_RX_DATA_PATH_CONF_GET_SB contents	242
5.131AWR_DEV_RX_DATA_PATH_LANEEN_GET_SB contents	243
5.132AWR_DEV_RX_DATA_PATH_CLK_GET_SB contents	243
5.133AWR_DEV_LVDS_CFG_GET_SB contents	243
5.134AWR_DEV_RX_CONTSTREAMING_CONF_GET_SB contents	244
5.135AWR_DEV_CSI2_CFG_GET_SB contents	244
5.136AWR_DEV_PMICCLOCK_CONF_GET_SB contents	244
5.137AWR_MSS_LATENTFAULT_CONF_GET_SB contents	244
5.138AWR_MSS_PERIODICTESTS_CONF_GET_SB contents	245
5.139AWR_DEV_TESTPATTERN_GEN_GET_SB contents	245
5.140AWR_DEV_FILE_DOWNLOAD_SB contents	245
5.141AWR_DEV_FRAME_CONFIG_APPLY_SB contents	246
5.142AWR_DEV_ADV_FRAME_CONFIG_APPLY_SB contents	247
5.143AWR_MSSVERSION_GET_SB contents	249
5.144AWR_MSSVERSION_SB contents	249
5.145AWR_MSSVERSION_SB contents	250
5.146AWR_MSSCPUFAULT_STATUS_SB contents	251
5.147AWR_MSSSESMFAULT_STATUS_GET_SB contents	252
5.148AWR_MSSSESMFAULT_STATUS_SB contents	252
5.149AWR_AE_DEV_MSSPOWERUPDONE_SB contents	255
5.150AWR_AE_DEV_RFPOWERUPDONE_SB contents	257

5.151	AWR_AE_MSS_CPUFAULT_STATUS_SB contents	259
5.152	AWR_AE_MSS_ESMFAULT_STATUS_SB contents	260
5.153	AWR_AE_MSS_BOOTERRORSTATUS_SB contents	263
5.154	AWR_AE_MSS_LATENTFAULT_TESTREPORT_SB contents	265
5.155	AWR_AE_MSS_PERIODICTEST_STATUS_SB contents	267
5.156	AWR_AE_MSS_RFERROR_STATUS_SB contents	267
5.157	AWR_AE_MSS_VMON_ERRORSTATUS_SB contents	268
5.158	AWR_AE_MSS_ADC_DATA_SB contents	269
6.1	Sequence of APIs to be issued to master and slave devices in cascaded mode configuration for FMCW mode measurements	272
6.2	Sequence of APIs to be issued to master and slave devices in cascaded mode for CW mode measurements	275
7.1	BSS API error codes	278
7.2	MSS API error codes (Applicable only in AWR1243/AWR2243)	286
7.3	Bit field describing the error status during boot on SPI	288
8.1	AWR_MONITOR_RF_DIG_LATENTFAULT_CONF_SB contents	292
8.2	AWR_MONITOR_RF_DIG_PERIODIC_CONF_SB contents	293
8.3	AWR_MONITOR_ANALOG_ENABLES_CONF_SB contents	294
8.4	AWR_MONITOR_TEMPERATURE_CONF_SB contents	296
8.5	AWR_MONITOR_RX_GAIN_PHASE_CONF_SB contents	298
8.6	AWR_MONITOR_RX_NOISE_FIGURE_CONF_SB contents	302
8.7	AWR_MONITOR_RX_IFSTAGE_CONF_SB contents	303
8.8	AWR_MONITOR_TX0_POWER_CONF_SB contents	304
8.9	AWR_MONITOR_TX1_POWER_CONF_SB contents	306
8.10	AWR_MONITOR_TX2_POWER_CONF_SB contents	307
8.11	AWR_MONITOR_TX0_BALLBREAK_CONF_SB contents	309
8.12	AWR_MONITOR_TX1_BALLBREAK_CONF_SB contents	310
8.13	AWR_MONITOR_TX2_BALLBREAK_CONF_SB contents	311
8.14	AWR_MONITOR_TX_GAIN_PHASE_MISMATCH_CONF_SB contents	312
8.15	AWR_MONITOR_TX0_BPM_CONF_SB contents	316
8.16	AWR_MONITOR_TX1_BPM_CONF_SB contents	317
8.17	AWR_MONITOR_TX2_BPM_CONF_SB contents	319
8.18	AWR_MONITOR_SYNTHESIZER_FREQUENCY_CONF_SB contents	321
8.19	AWR_MONITOR_EXTERNAL_ANALOG_SIGNALS_CONF_SB contents	324
8.20	AWR_MONITOR_TX0_INTERNAL_ANALOG_SIGNALS_CONF_SB contents	327
8.21	AWR_MONITOR_TX1_INTERNAL_ANALOG_SIGNALS_CONF_SB contents	328
8.22	AWR_MONITOR_TX2_INTERNAL_ANALOG_SIGNALS_CONF_SB contents	329
8.23	AWR_MONITOR_RX_INTERNAL_ANALOG_SIGNALS_CONF_SB contents	330
8.24	AWR_MONITOR_PMCLKLO_INTERNAL_ANALOG_SIGNALS_CONF_SB contents	330
8.25	AWR_MONITOR_GPADC_INTERNAL_ANALOG_SIGNALS_CONF_SB contents	332
8.26	AWR_MONITOR_PLL_CONTROL_VOLTAGE_CONF_SB contents	332

8.27	DCC Clock monitor pairs	334
8.28	AWR_MONITOR_DUAL_CLOCK_COMP_CONF_SB contents	334
8.29	AWR_MONITOR_RX_SATURATION_DETECTOR_CONF_SB contents	336
8.30	AWR_MONITOR_RX_SIG_IMG_MONITOR_CONF_SB contents	338
8.31	AWR_MONITOR_MIXER_IN_POWER_CONF_SB contents	339
8.32	AWR_ANALOG_FAULT_INJECTION_CONF_SB contents	341
11.1	Minimum chirp cycle time	358
11.2	Minimum inter burst time	359
11.3	Minimum inter sub-frame/frame time	360
12.1	Duration of boot time calibrations	361
12.2	Duration of run time calibrations	362
12.3	Duration of analog monitors	363
12.4	Duration of digital monitors	363
12.5	Software overheads every FTTI that should be accounted to program CALIB_ MON_TIME_UNIT and CALIBRATION_PERIODICITY	364

Revision History

Revision	Date	Description
0.97	13.09.2018	<ol style="list-style-type: none">1. Added a new parameter CASCADING_PINOUT_CFG in AWR_CHAN_CONF_SET_SB in Section 5.2.1 on page 47.2. Added a new parameter PA LDO disable in AWR_RF_LDO_BYPASS_SB API in Section 5.11.6 on page 156.3. Added new APIs AWR_PHASE_SHIFTER_CAL_DATA_SAVE_SB in page 69 and AWR_PHASE_SHIFTER_CAL_DATA_RESTORE_SB in page 62.4. Added a new parameter LDO_SC_MONITORING_EN in AWR_MONITOR_ANALOG_ENABLES_CONF_SB in page 294.5. Fixed the length for the SBLKID AWR_DEV_CONFIGURATION_SET_SB in page 241.6. Added a note in AWR_CHIRP_CONF_SET_SB in page 82 that dither parameters are only additive to the programmed parameters in AWR_PROFILE_CONF_SB.7. Updated the valid range of SFx_PERIOD parameter in AWR_ADVANCED_FRAME_CONF_SB in page 89 to 1.342 s.8. Added a note below AWR_SUBFRAME_START_CONF_SB on page 129 indicating that watchdog feature is not available when software based sub-frame trigger mode is used.9. Added new parameters in AWR_MONITOR_PMCLKLO_INTERNAL_ANALOG_SIGNALS_CONF_SB in page 330 for 20 GHz sync signal monitoring. Also updated AWR_MONITOR_PMCLKLO_INTERNAL_ANALOG_SIGNALS_REPORT_AE_SB in page 210 with 20 GHz monitoring report.

10. Added parameters in `AWR_MONITOR_TXn_BPM_CONF_SB` in page numbers 199, 200 and 202 for phase shifter monitoring. Also updated `AWR_MONITOR_TXn_BPM_REPORT_AE_SB` in pages 199, 200 and 202 for phase shifter monitoring reports.
11. Added a note in page 102 indicating that programmable filter APIs should not be issued when frames are ongoing.
12. Updated the mapping of `PGA_GAIN_INDEX` numbers to gain values in `AWR_RF_PSLOOPBACK_CFG_SB` in page 159.
13. Added a note after `AWR_BPM_CHIRP_CONF_SET_SB` in page 134 and `AWR_PERCHIRPPHASESHIFT_CONF_SB` in page 99 indicating when the BPM and phase shifters are applied.
14. Added `TX_CAL_EN_CFG` parameter in `AWR_PROFILE_CONF_SET_SB` in page 72.
15. Added a note in `AWR_RF_INIT_CALIBRATION_CONF_SB` in page 57 indicating that if TX boot time calibration is disabled, no other backoff other than 0 dB is supported.
16. Added the monitoring duration of TX phase shifter in Table 12.3 in page 363.
17. Added a new API `AWR_RF_DIEID_GET_SB` in page 142 which reads the Die ID of the device.
18. Added a note in section `AWR_LOOPBACK_BURST_CONF_SET_SB` in page 114 indicating that when using loopback burst, the corresponding sub-frame in advanced frame configuration should use `SFx_NUM_UNIQUE_CHIRPS_PER_BURST` as 1.
19. Corrected the sequence of issuing APIs in page 270 - loopback burst config API should be issued after profile config API.
20. Updated error code 49 in Table 7.1 to include the maximum sampling rate based on device variant.
21. Added a note in page 364 explaining the watchdog clearing window calculation by the firmware.
22. Added a note in page 106 indicating if user has not enabled any one time calibrations, but if calibration report is enabled, then after issuing the `AWR_RUN_TIME_CALIBRATION_CONF_AND_TRIGGER_SB` API, the firmware will immediately sent out a calibration report.
23. Added the `RFLDOBYPASS_EN` API after `AWR_ADCOUT_CONF_SET_SB` in Table 6.1, Table 6.3, Table 6.1 and Table 6.2.

24. Added a note after [AWR_FRAME_CONF_SET_SB](#) indicating the pulse width requirements of the SYNC_IN pulse in hardware triggered mode.
25. Added a new parameter CHIRP_ROW_SELECT in [AWR_DYN_CHIRP_CONF_SET_SB](#) API in page 120 to enable faster configuration of chirps dynamically.
26. Updated the definition of REPORTING_MODE in [AWR_MSS_LATENTFAULT_TEST_CONF_SB](#) and [AWR_MSS_PERIODICTESTS_CONF_SB](#) APIs in pages 235 and 236.
27. Added new error code 159 to indicate incorrect CHIRP_ROW_SELECT value and updated error code 135 to account for CHIRP_ROW_SELECT values.
28. Added new error codes 1040, 1041, 1042, 1043, 1044, 1045, 1046, 1047, 1048 and 1050 in Table 7.2 in page 286.
29. Added examples of PMIC clock configuration in Section 5.16.9 in page 231.
30. Added a note in [AWR_ANALOG_FAULT_INJECTION_CONF_SB](#) in page 341 under SUPPLY_LDO_FAULT indicating that this fault ineffective under LDO_BYPASS condition.
31. Added a note about when to stop the frames when using sub-frame trigger or hardware trigger mode in page 128.
32. Updated font type to Helvetica.
33. Added a note about usage of CW CZ mode in page 86.
34. Added a note about TX3 gain and phase imbalance offset wrt. TX1 and TX2 in page 312.
35. Added a note about inter-burst idle time requirement in page 51.
36. Added a note about Noise figure Values reporting in NF Monitoring report AE in page 187.
37. Added a note in MSS powerup done AE in page 255.
38. Added a note about Tx output Power backoff in profile config API in page 72.
39. Added a note about Tx output Power monitoring in page 191.
40. Added a note about Programmable filter tap start index selection in page 100.
41. Added a note in [AWR_AE_MSS_BOOTERRORSTATUS_SB](#) AE in page 263.
42. Updated runtime VCO calibration time in page 361.
43. Updated VCO control voltage monitor upper threshold in page 212.

Revision	Date	Description
1.0	24.09.2018	<ol style="list-style-type: none"> Changed document name to "mmWave-Radar-Interface-Control.pdf" Updated supported device list and added two new IWR6843 60GHz and xWR1843 77GHz TI mmWave radar devices Added 60GHz RF frequency and slope programming details in following API sub-blocks AWR_CAL_MON_FREQUENCY_LIMITS_SB AWR_CAL_MON_FREQUENCY_TX_POWER_LIMITS_SB AWR_PROFILE_CONF_SB AWR_CHIRP_CONF_SET_SB AWR_CONT_STREAMING_MODE_CONF_SET_SB AWR_LOOPBACK_BURST_CONF_SET_SB AWR_DYN_CHIRP_CONF_SET_SB Added IWR6843 ES1.0 limitations in following API sub-blocks AWR_CAL_MON_FREQUENCY_LIMITS_SB AWR_CAL_MON_FREQUENCY_TX_POWER_LIMITS_SB AWR_RF_INIT_CALIBRATION_CONF_SB AWR_CAL_DATA_RESTORE_SB AWR_CAL_DATA_SAVE_SB AWR_CAL_DATA_SAVE_SB AWR_PROFILE_CONF_SB AWR_CONT_STREAMING_MODE_CONF_SET_SB AWR_PERCHIRPPHASESHIFT_CONF_SB AWR_RUN_TIME_CALIBRATION_CONF_AND_TRIGGER_SB AWR_RX_GAIN_TEMPLUT_SET_SB AWR_TX_GAIN_TEMPLUT_SET_SB AWR_LOOPBACK_BURST_CONF_SET_SB AWR_DYN_PERCHIRP_PHASESHIFTER_CONF_SET_SB AWR_SUBFRAME_START_CONF_SB AWR_RX_GAIN_TEMPLUT_GET_SB AWR_TX_GAIN_TEMPLUT_GET_SB AWR_BPM_COMMON_CONF_SET_SB AWR_BPM_CHIRP_CONF_SET_SB AWR_RF_BOOTUPBIST_STATUS_DATA_SB AWR_RF_PALOOPBACK_CFG_SB AWR_RF_PSLOOPBACK_CFG_SB AWR_RF_IFLOOPBACK_CFG_SB AWR_RF_TEMPERATURE_GET_SB AWR_RF_DIEID_GET_SB AWR_DYN_CHIRP_CONF_SET_SB AWR_RF_TEST_SOURCE_CONFIG_SET_SB Radar Monitoring APIs Async event sub-blocks

Revision	Date	Description
1.1	10.10.2018	<ol style="list-style-type: none">1. Updated AWR_DEV_LVDS_CFG_SET_SB subblock in page 226.2. Updated note on VCO selection in page 723. Added a note in Noise figure monitoring configuration SBC 301

Revision	Date	Description
1.2	19.01.2019	<ol style="list-style-type: none">1. Updated 60GHz VCO2 frequency range and Tx output power backoff support for IWR6843 in page 722. Updated MONITOR_START_TIME range in AWR_MONITOR_SYNTHESIZER_FREQUENCY_CONF_SB in page 3213. Removed ESM periodic monitoring support in AWR_MONITOR_RF_DIG_PERIODIC_CONF_SB in page 2934. Added TX Phase Shifter Status flag in AWR_MONITOR_TX0/1/2_BPM_REPORT_AE_SB in page 1995. Added Programmable filter Fatal error flags in BSS ESM G1 AE report AWR_AE_RF_ESMFAULT_STATUS_SB in page 1676. Added FRC Lock step Fatal error flag in MSS ESM G1 AE report AWR_AE_MSS_CPUFAULT_STATUS_SB in page 2607. Added a note on timing and handling of monitoring Async Events at the beginning of AWR_RF_ASYNC_EVENT_MSG1 section in page 1668. Added a note on Frame Stop functionality and timing in AWR_FRAMESTARTSTOP_CONF_SB in page 1329. Added a note on MSS max monitoring period in AWR_MSS_PERIODICTESTS_CONF_SB in page 23510. Removed Rx Power detect monitoring and its status in AWR_MONITOR_RX_INTERNAL_ANALOG_SIGNALS_REPORT_AE_SB in page 20911. Added a note on WDT timer enable conditions in AWR_RF_DEVICE_CFG_SB in page 5312. Added a note on external GPADC signal measurement report in AWR_RF_GPADC_CFG_SET_SB in page 16113. Updated Calibration periodicity valid range in AWR_RUN_TIME_CALIBRATION_CONF_AND_TRIGGER_SB in page 10314. Updated CAL_MON_TIME_UNIT period valid range in AWR_CALIB_MON_TIME_UNIT_CONF_SB in page 10215. Updated note on Noise figure Values reported in NF Monitoring report AE in page 187.

Revision	Date	Description
1.3	07.03.2019	<ol style="list-style-type: none">1. Added Rx Power detect monitoring and its status in AWR_MONITOR_RX_INTERNAL_ANALOG_SIGNALS_REPORT AE SB in page 2092. The PCR Test (b26) in AWR_MONITOR_RF_DIG_LATENTFAULT_CONF_SB is not recommended to use (refer latest release note) in page 2913. Added a device API protocol limitation related to CRC in page 13

Revision	Date	Description
1.4	25.03.2019	<ol style="list-style-type: none">1. Please refer Latest DFP release Note for all known issues and de-featured APIs.2. Added a note on destructive tests in AWR_MSS_LATENTFAULT_TEST_CONF_SB in page 2363. Updated PASS and FAIL bit definition/values in AWR_AE_DEV_MSSPOWERUPDONE_SB AND AWR_AE_MSS_BOOTERRORSTATUS_SB in page 255 and 263 respectively.4. Added new files type in AWR_DEV_FILE_DOWNLOAD_SB in page 245.

Revision	Date	Description
1.5	18.04.2019	<ol style="list-style-type: none">1. Added new fields in AWR_MONITOR_RX_GAIN_PHASE_REPORT_AE_SB in page 183.2. Added reporting mode field in AWR_MONITOR_RX_GAIN_PHASE_CONF_SB in page 298.3. Added reporting mode field in AWR_MONITOR_TX_GAIN_PHASE_MISMATCH_CONF_SB in page 312.4. Added new field NUM_OF_DUMMY_CHIRPS_AT_THE_END in AWR_FRAME_CONF_SET_SB in page ??.5. Added a note on minimum chirp duration in AWR_PROFILE_CONF_SET_SB in page 72.6. Added a new BSS fault type in AWR_AE_MSS_RFERROR_STATUS_SB in page 267.7. Added a note on RadarSS monitoring failure report redundancy for quiet mode in page 166.8. Updated AWR_MSSESMFAULT_STATUS_GET_SB to match with AWR_MSS_ESMFAULT_STATUS_SB in page 252.9. Updated description for error code 48 in page 27810. Updated API sequence description in page 27011. Added few notes in Rx saturation and signal image monitor configurations and sequence to follow in page 33512. De-featured PCR self test in AWR_MONITOR_RF_DIG_LATENTFAULT_CONF_SB in page 291, refer latest release note for more info.13. De-featured PCR self test in AWR_MSS_LATENTFAULT_TEST_CONF_SB in page 236, refer latest release note for more info.14. De-featured LPF monitor in AWR_MONITOR_RX_IFSTAGE_CONF_SB in page 30315. De-featured Rampgen clock monitor in AWR_MONITOR_DUAL_CLOCK_COMP_CONF_SB in page 33316. De-featured Rampgen ECC self test monitor in AWR_MONITOR_RF_DIG_LATENTFAULT_CONF_SB in page 29117. Added a note on synth frequency monitor configuration sequence in page 321

Revision	Date	Description
1.6	28.04.2019	<ol style="list-style-type: none">1. Updated Rx gain computation formula in AWR_MONITOR_RX_GAIN_PHASE_REPORT_AE_SB in page 183.2. Added detailed description on calibration data and usage notes in AWR_CAL_DATA_RESTORE_SB in page 61 and in AWR_CAL_DATA_SAVE_SB in page 65.3. Added a note on Hw triggered mode and timing of Hw pulse in page 83.4. Added a note on Hw triggered mode and timing of Hw pulse in page 89.5. Added calibration restore and monitoring APIs sequence order in page 2706. Added a note on monitoring APIs configuration sequence in page 2917. Added a note on using TEST_MODE in RF digital monitoring API configuration in page 2918. Added a note on using analog fault injection API in page 3419. Disabled RX power detector internal signal monitor in AWR_MONITOR_RX_INTERNAL_ANALOG_SIGNALS_CONF_SB monitor and corresponding status bits made reserved in AWR_MONITOR_RX_INTERNAL_ANALOG_SIGNALS_REPORT_AE_SB AE.10. Added PCR test status in AWR_AE_DEV_MSSPOWERUPDONE_SB AE in page 25511. Added new section about unsupported features and debug APIs in page 34812. Added notes about valid conditions to enable AWR_MSS_PERIODICTESTS_CONF_SB and AWR_MSS_LATENTFAULT_TEST_CONF_SB APIs in page 235 and 23613. Added a note about interference mitigation for boot calibrations in AWR_RF_INIT_SB API in page 72

Revision	Date	Description
1.7	10.07.2019	<ol style="list-style-type: none">1. De-featured VIM interrupt self test (vim test) from RF digital boot and latent monitoring in 143, 257, 291.2. Updated test source BOUNDARY_MIN_VECx and BOUNDARY_MAX_VECx axes 154.3. De-featured VCO slope monitoring in AWR_MONITOR_PLL_CONTROL_VOLTAGE_REPORT_AE_SB for 1st gen devices (please refer latest DFP 1.x release notes) 2124. De-featured VCO SYNTH_VCO_OPENLOOP fault injection in AWR_ANALOG_FAULT_INJECTION_CONF_SB for 1st gen devices (please refer latest DFP 1.x release notes) 3415. Updated Rx gain computation formula in AWR_MONITOR_RX_GAIN_PHASE_REPORT_AE_SB in page 183.

Revision	Date	Description
1.8	21.11.2019	<ol style="list-style-type: none">1. Updated Calibration structure definition for xWR6843 devices in page 672. Updated few API descriptions.3. Added new error code 160 in 278.4. Updated RF gain modes for xWR6843.5. Updated RF gain targets for xWR6843 ES2.

Revision	Date	Description
1.9	6.1.2020	<ol style="list-style-type: none">1. Removed some unnecessary references to IWR6843 ES1.0.2. Updated a few API descriptions.3. Updated one of the RF gain targets for xWR6843 ES2 from 34dB to 33dB.4. Updated calibration and frame/burst/chirp timing information.

Revision	Date	Description
1.10	19.4.2020	<ol style="list-style-type: none"> 1. Updated a few API descriptions. 2. Added new section to provide details about Chirp, Burst and Frame timings of device in page 358 3. Added a new API AWR_APLL_SYNTH_BW_CONTROL_SB in page 64 only for xWR6843 device. 4. Added a new AWR_POWER_SAVE_MODE_CONF_SET_SB in page 135 only for xWR6843 device. 5. Removed phase shifter monitor status flag from AWR_MONITOR_TXn_BPM_REPORT_AE_SB in page 199, 200 and 202. 6. Added new TX Phase shifter DAC monitor settings and reports in TXn internal analog signal monitors at 327 and 205. 7. removed 20G signal monitor status flag from AWR_MONITOR_PMCLKLO_INTERNAL_ANALOG_SIGNALS_REPORT_AE_SB in page 210 8. removed LPF monitor status flag from AWR_MONITOR_RX_IFSTAGE_REPORT_AE_SB in page 189 9. removed VCO slope monitor status flag from AWR_MONITOR_PLL_CONTROL_VOLTAGE_REPORT_AE_SB in page 212 10. removed Rampgen DCC monitor status flag from AWR_MONITOR_DUAL_CLOCK_COMP_REPORT_AE_SB in page 213 11. Added a new feature MONITOR_CONFIG_MODE in AWR_MONITOR_SYNTHESIZER_FREQUENCY_CONF_SB in page 321. 12. Added a new Async Event AWR_MONITOR_SYNTHESIZER_FREQUENCY_NONLIVE_REPORT_AE_SB in page 216. 13. Added recommended value for MONITOR_START_TIME in AWR_MONITOR_SYNTHESIZER_FREQUENCY_CONF_SB API in page 321

Revision	Date	Description
1.10	21.4.2020	<ol style="list-style-type: none">1. Updated few status flags in AWR_AE_DEV_MSSPOWERUPDONE_SB API in page 2552. Updated few status flags in AWR_MSSCPUFAULT_STATUS_GET_SB API in page 2503. Updated few status flags in AWR_AE_MSS_CPUFAULT_SB API in page 2594. Updated few status flags in AWR_AE_MSS_BOOTERRORSTATUS_SB API in page 2635. Updated few status flags in AWR_AE_MSS_ESMFAULT_STATUS_SB API in page 2606. Updated few status flags in AWR_MSS_LATENTFAULT_TEST_CONF_SB API in page 2367. Removed 900 Mbps (DDR only) data rate in AWR_DEV_RX_DATA_PATH_CLK_SET_SB API in page 2258. Added application care about notes in Communication Sequence section.9. Updated API programming sequence section in page 27010. Added new notes related to minimum chirp cycle time in AWR_PROFILE_CONF_SET_SB API in page 7211. Updated notes related to minimum burst time in AWR_FRAME_CONF_SET_SB and AWR_ADVANCED_FRAME_CONF_SB APIs in page 83 and 8912. Added new notes in AWR_CAL_MON_FREQUENCY_LIMITS_SB and AWR_CAL_MON_FREQUENCY_TX_POWER_LIMITS_SB APIs in page 5913. Updated few API descriptions and added new error codes for Synth frequency monitor.14. Added new notes in AWR_BPM_CHIRP_CONF_SET_SB API in page 13415. Updated calibration and monitoring duration in 361

Revision	Date	Description
1.11	4.6.2020	<ol style="list-style-type: none">1. Updated the format of the phase shifter calibration data in AWR_PHASE_SHIFTER_CAL_DATA_SAVE_SB in page 69 and AWR_PHASE_SHIFTER_CAL_DATA_RESTORE_SB in page 62.2. Added a table of typical settings for the fields in AWR_APLL_SYNTH_BW_CONTROL_SB API in page 64 (Only for xWR6x43 devices).3. Updated the valid range of values allowed for the frequency slope in xWR6x43 devices.4. Added a few more details on the temperature field in the runtime calibration summary report.5. Updated the actual RX gain computation from the gain values returned by AWR_MONITOR_RX_GAIN_PHASE_REPORT_AE_SB in page 183.6. Added a new MON_START_FREQ_CONST field to the AWR_MONITOR_TXx_BALLBREAK_CONF_SB APIs (only for xWR6x43 devices).7. Added TX Phase shifter DAC monitor disable option in TXn internal analog signal monitors at page 327

NOTE1: Please refer latest mmWave device DFP release notes for all known issues and de-featured APIs

NOTE2: All reserved bytes/bits in configuration API sub blocks shall be programmed with value zero. The functionality of radar device is not guaranteed if reserved bytes are not zero.

NOTE3: All reserved bytes/bits in API message reports (ack or AE) sub blocks shall be masked off in application.

1 Introduction

1.1 Scope

The Scope of this document is to define interface control specifications for wide range of TI mmWave sensors. The wide range of highly integrated 77GHz and 60GHz CMOS TI mmwave sensors are tabulated in table 1.1. The devices integrate all of the RF and Analog functionality, including VCO, PLL, PA, LNA, Mixer and ADC for multiple TX/RX channels into a single chip. The AWR1243 is an RF transceiver device and it includes 4 receiver channels and 3 transmit channels in a single chip. The AWR1243 supports multi-chip cascading. The xWR1642, xWR1843 and xWR6843 are radar-on-a-chip devices, which includes 4 receive channels and 2 or 3 transmit channels and additionally an integrated DSP for radar signal processing.

The device includes a Radar Sub-System (RadarSS) also called Built-in Self-Test (BSS) processor, which is responsible to configure the RF/Analog and digital front-end in real-time, as well as to periodically schedule calibration and functional safety monitoring. This enables the mmWave front-end to be self-contained and capable of adapting itself to handle temperature and ageing effects, and to enable significant ease-of-use from an external host perspective.

This document contains the Interface Control Specification for communications on the serial interface (SPI) between the Radar device and the external host processor. The same protocol is used in all devices when the messages are sent to Radar Control subsystem (BIST subsystem) from the MCU subsystem (Master subsystem) and DSP subsystems.

Refer Link <http://www.ti.com/sensors/mmwave/overview.html> for more informations.

Table 1.1: TI CMOS mmWave radar devices

Frequency Type	60GHz RF Frequency (57GHz to 64GHz)	77GHz RF Frequency (76GHz to 81GHz)
TI Automotive Radar Devices	NA	AWR1243, AWR1642, AWR1443, AWR1843
TI Industrial Radar Devices	xWR6843	IWR1642, IWR1443, IWR1843

1.2 Intended Audience

The intended audience for this document is firmware, host software, and validation engineers needing to understand the format and contents of all communications between the Radar device

and the host processor.

2 TI mmWave Radar Sensor Communications Overview

2.1 Communication Link Description

The AWR1243 radar device communicates with the external host processor using the SPI interface. The radar device is configured and controlled from the external host processor by sending commands to AWR1243 device over SPI.

The xWR1642, xWR1843 and xWR6843 radar device is configured and controlled using the internal MCU (Master subsystem) and it communicates with an external ECU using the CAN interface.

This document only talks about the communication protocol between radar device and external host processor using SPI in AWR1243. In xWR1642, xWR1843 and xWR6843 the same protocol is used to communicate between the BIST subsystem and Master subsystem.

2.2 Communication Link configuration

2.2.1 SPI

This interface is synchronous. The interface includes four signals (SPICCLK, SPICS, and Data In and Data Out) and supports clock rates up to 40 MHz. The AWR1243 radar device is always the SPI slave and the external host processor will be the SPI master.

2.2.2 Mailbox

This interface includes a SRAM and an interrupt line from Master subsystem to BIST subsystem. A reverse channel which includes a different SRAM and a different interrupt line from the BIST subsystem to Master subsystem is used for responses which originate from BIST subsystem.

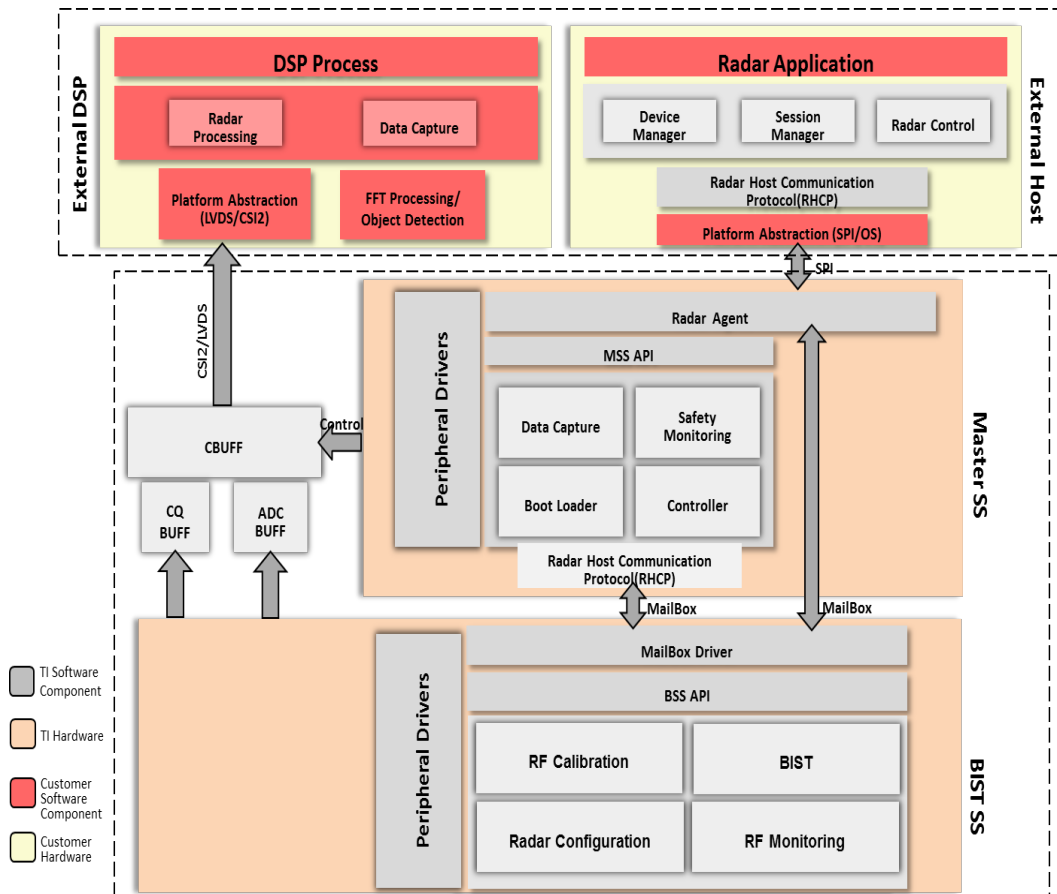

Figure 2.1: AWR12xx, AWR22xx Software Architecture

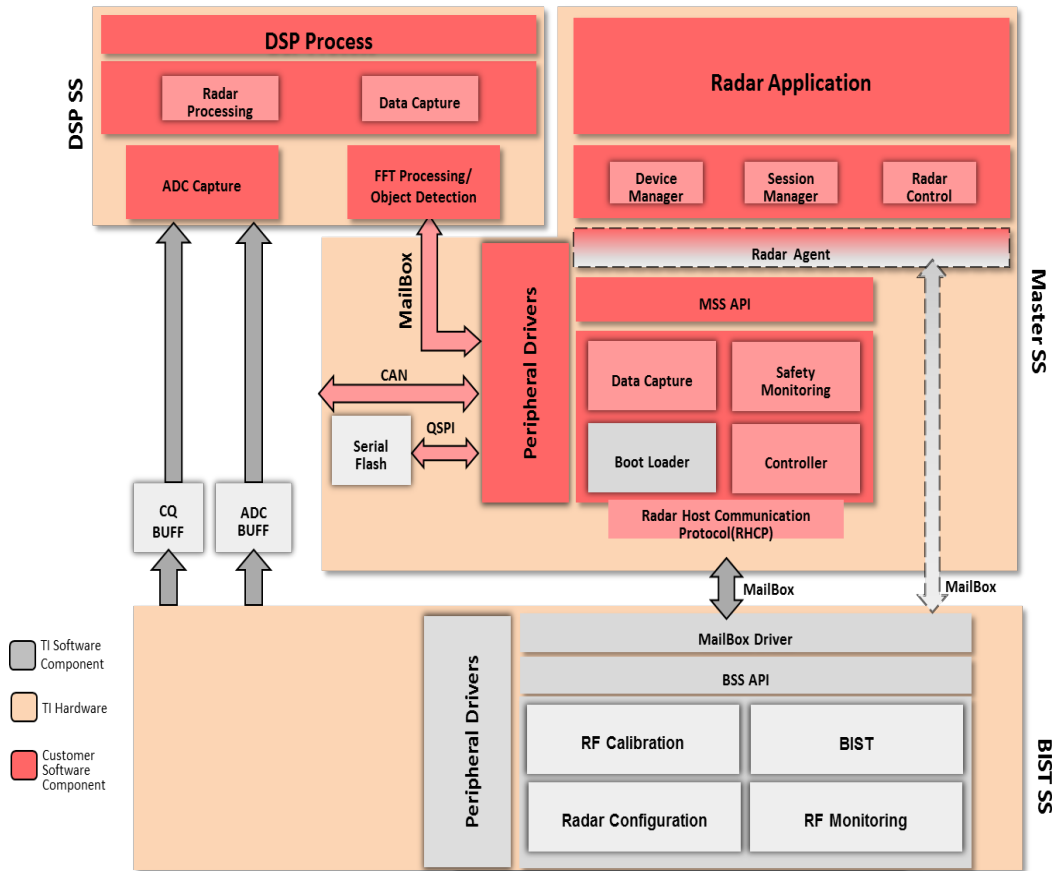

Figure 2.2: xWR16xx, xWR18xx and IWR68xx Software Architecture

2.3 Radar Message Structure

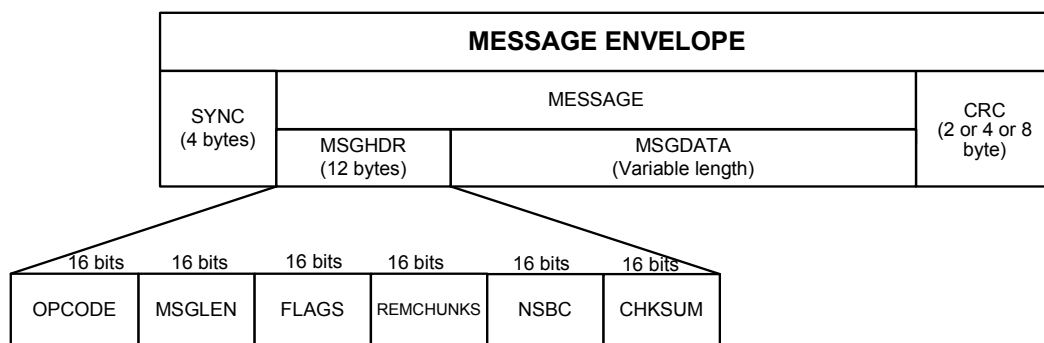

Figure 2.3: Radar Message Structure

Each message is sent in a message envelope, which starts with four special bytes called a sync pattern. Next, the message envelope contains the actual message and a CRC converted to a stream of bytes. Figure 2.3 defines the general form of radar messages. All communication messages between external host processor and the radar device will follow this message format. Each message consists of a 12-byte message header, variable length message data followed by a variable length CRC.

NOTE: The CRC and all the fields in the message headers and message data that are larger than one byte are sent in little-endian byte order i.e. the least significant byte is sent first.

A message envelope contains only one message.

2.3.1 SYNC

SYNC is a unique 4 byte pattern which marks the start of the message. It can take one of the following 3 values, in memory all the bytes are stored in little endian format (least significant byte first).

Table 2.1: Possible SYNC values and their usage

SYNC word value	Description
0x43211234	Messages from master to slave indicating a new command
0x87655678	Messages from external host to device indicating the host is now ready to receive a message from the device This pattern is defined as CNYS in this document.
0xABCDDCBA	Messages from slave to master

2.3.2 MSGHDR

Figure 2.4 defines the content of the message header. Each radar message must begin with this 12 byte message header in little endian format.

OPCODE (16 bits)	LENGTH (16 bits)	FLAGS (16 bits)	REMCHUNKS (16 bits)	NSBC (16 bits)	CHKSUM (16 bits)

Figure 2.4: Message Header Format

15	14	13	12	11	10	9	8	7	6	5	4	3	2	1	0
MSGID										MSGTYPE		DIRECTION			

Figure 2.5: OPCODE Format

OPCODE

The OPCODE is unique for a given message type. Figure 2.5 defines the OPCODE format.

Bits	Field	Description
[3:0]	DIRECTION	Direction of command 0000 Invalid 0001 Communication between Host to BSS 0010 Communication between BSS to Host 0011 Communication between Host to DSS 0100 Communication between DSS to Host 0101 Communication between Host to Master 0110 Communication between Master to Host 0111 Communication between BSS to Master 1000 Communication between Master to BSS 1001 Communication between BSS to DSS 1010 Communication between DSS to BSS 1011 Communication between Master to DSS 1100 Communication between DSS to Master 1101 RESERVED 1110 RESERVED 1111 RESERVED
[5:4]	MSGTYPE	Message type 00 COMMAND 01 RESPONSE (ACK or ERROR) 10 NACK 11 ASYNC
[15:6]	MSGID	Message ID 0x00 AWR_ERROR_MSG 0x01 RESERVED 0x02 RESERVED 0x03 RESERVED 0x04 AWR_RF_STATIC_CONF_SET_MSG 0x05 AWR_RF_STATIC_CONF_GET_MSG 0x06 AWR_RF_INIT_MSG 0x07 RESERVED 0x08 AWR_RF_DYNAMIC_CONF_SET_MSG 0x09 AWR_RF_DYNAMIC_CONF_GET_MSG 0x0A AWR_RF_FRAME_TRIG_MSG 0x0B RESERVED

		0x0C	AWR_RF_ADVANCED_FEATURES_CONF_SET_MSG
		0x0D	RESERVED
		0x0E	AWR_RF_MONITORING_CONF_SET_MSG
		0x0F	RESERVED
		0x10	RESERVED
		0x11	AWR_RF_STATUS_GET_MSG
		0x12	RESERVED
		0x13	AWR_RF_MONITORING_REPORT_GET_MSG
		0x14	RESERVED
		0x15	RESERVED
		0x16	AWR_RF_MISC_CONF_SET_MSG
		0x17	AWR_RF_MISC_CONF_GET_MSG
		0x18	RESERVED
		0x19	RESERVED
		0x80	AWR_RF_ASYNC_EVENT_MSG1
		0x81	AWR_RF_ASYNC_EVENT_MSG2
		0x200	AWR_DEV_RFPOWERUP_MSG
		0x201	RESERVED
		0x202	AWR_DEV_CONF_SET_MSG
		0x203	AWR_DEV_CONF_GET_MSG
		0x204	AWR_DEV_FILE_DOWNLOAD_MSG
		0x205	RESERVED
		0x206	AWR_DEV_FRAME_CONFIG_APPLY_MSG
		0x207	AWR_DEV_STATUS_GET_MSG
		0x208	RESERVED
		0x209	RESERVED
		0x20A	RESERVED
		0x20B	RESERVED
		0x20C	RESERVED
		0x20D	RESERVED
		0x280	AWR_DEV_ASYNC_EVENT_MSG

LENGTH

The length field contains the length of the message in bytes including the message header, message data and CRC. Note that length field does not include the length of the sync field. The minimum length of the message is 12 bytes and maximum is 252 bytes. The message length minus CRC length must also be a multiple of 4 bytes.

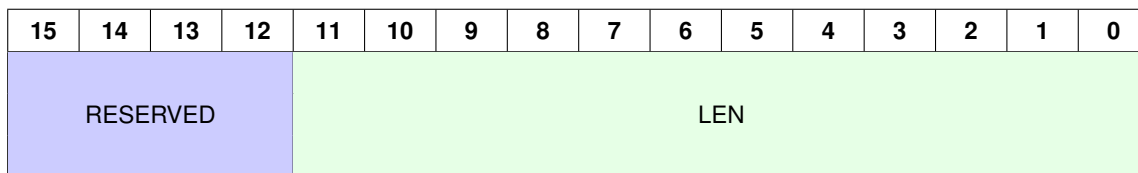

Figure 2.6: MSGLEN Format

Table 2.3: MSGLEN field descriptions

Bits	Field	Description
[11:0]	LEN	Message length in bytes (It includes message header, message data and CRC)
[15:12]	RESERVED	Keep these bits as 0s

FLAGS

The FLAGS is used to control the communication between the radar device and external host

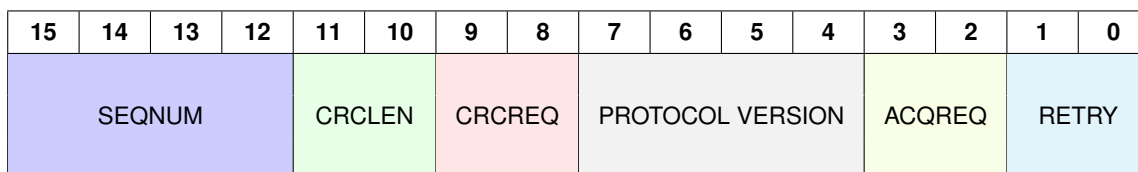

Figure 2.7: FLAGS Format

Table 2.4: FLAGS field description

Bits	Field	Description
[1:0]	RETRY	RETRY Value 00 New message 11 Retransmitted message 01 RESERVED 10 RESERVED
[3:2]	ACKREQ	Acknowledgement Request type 00 Acknowledgement is requested for the current message 11 Acknowledgement is not requested for the current message 01 RESERVED 10 RESERVED

Continued on next page

Table 2.4 – continued from previous page

[7:4]	PROTOCOL VERSION	Version number of the protocol that is used to communicate with the device (4 bits)
[9:8]	CRCREQ	CRC request type 00 CRC is appended to the message 11 CRC is not appended to the message 01 RESERVED 10 RESERVED
[11:10]	CRCLEN	Length of CRC appended to the message 00 16-bit CRC 01 32-bit CRC 10 64-bit CRC 11 RESERVED
[15:12]	SEQNUM	4 bit sequence number of the message. Sequence number is reset to 0 after a device boot and each new message has the incremented sequence number. Whenever the same message is retransmitted, the sequence number is not incremented.

NOTE: It is recommended to always append CRC to the message to prevent any message integrity issues

REMCHUNKS

If the message length is larger than 256 bytes, then it is split into multiple chunks of sizes less than 256 bytes. When this field is non-zero, this field indicates the number of remaining chunks that are to be expected.

NSBC

The message may contain several configuration sub blocks with structure as defined in Figure 2.3. The NSBC field indicates the total number sub blocks inside the message data.

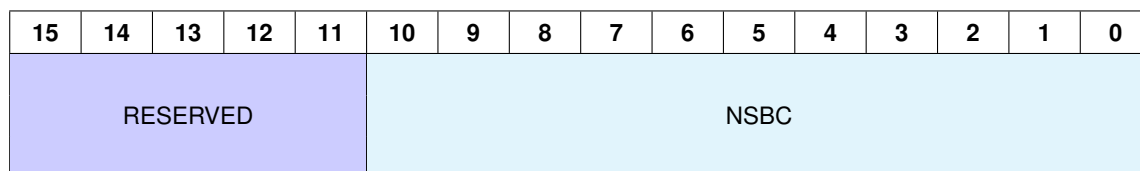

Figure 2.8: NSBC Format

Table 2.5: NSBC field description

Bits	Field	Description
[10:0]	NSBC	Number of sub blocks in the message
[15:11]	RESERVED	Keep these bits as 0s

CHKSUM

The message header is protected by a 16-bit checksum to enable the receiver to check the integrity of the message header. The checksum is computed on MSGHDR only (MSGID, MSGLEN, FLAGS, REMCHUNKS and NSBC fields). Note that SYNC field is not included in checksum calculation.

Checksum is 16-bit one's complement of the one's complement sum of all 16-bit words in the message header (Ref. <https://tools.ietf.org/html/rfc1071>).

For e.g., suppose the message header contents looks like this

Table 2.6: Checksum computation example

Field	Value
OPCODE	0x0281
MSGLEN	0x0800
FLAGS	0x040C
REMCHUNKS	0x0000
NSBC	0x0001
CHKSUM	0xF171

The receiver will compute the checksum as follows $0x0281 + 0x0800 = 0x0A81$.

Then, $0x0A81 + 0x040C = 0x0E8D$.

Then, $0x0E8D + 0x0000 = 0x0E8D$.

Then, $0x0E8D + 0x0001 = 0x0E8E$.

The carry bits generated beyond 16 bits should be added back to result

Ones complement of $0x0E8E$ is $0xF171$ which matches with the received checksum.

2.3.3 MSGDATA

The message data contains the actual message specific data for the message. The message data contains sub blocks with structure as defined in Figure 2.9. More than one sub block can be appended in the MSGDATA to reduce the overall communication latency. The total number of sub blocks in MSGDATA is indicated in the NSBC field in the MSGHDR.

All data fields are aligned so that their offset in message is a multiple of the field size in bytes. For e.g. a 32 bit field in the message will be aligned to a 4 byte boundary and a 16 bit field will

be aligned to a 2 byte boundary. This makes it possible to create a structure definition for the message for easy data access in most environments.

Any reserved (currently unused) fields in the messages should be always set as 0 when sent and ignored when received. This way those fields may be taken to use in later interface versions without modifying all old software.

All data structure in sub-blocks assumed to be in little endian format. For big endian Host system byte swap is required to match with defined protocol.

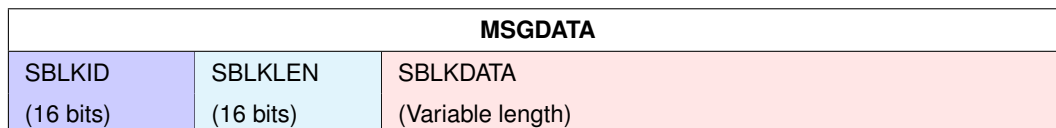

Figure 2.9: Message Sub block structure

SBLKID Unique ID of the sub block

SBLKLEN Length of the sub block in bytes

SBLKDATA Data corresponding to the sub block

2.3.4 CRC

This is a CRC which is appended to the message data to protect the integrity of the message. The CRC is computed on all the bytes in the MSGHDR and MSGDATA. Note that SYNC is not included in CRC calculation.

3 different types of CRCs can be used – 16 bit, 32 bit or 64 bit. The choice of the CRC type is indicated in the FLAGS field in the MSGHDR.

The 32 bit CRC is recommended CRC to be used in SPI protocol.

The polynomials used for each type of CRC calculation are

Table 2.7: CRC types and their polynomials

CRC type	Polynomial	Remarks
16 bit	$x^{16} + x^{12} + x^5 + 1$	16-bit CRC-CCITT
32 bit	$x^{32} + x^{26} + x^{23} + x^{22} + x^{16} + x^{12} + x^{11} + x^{10} + x^8 + x^7 + x^5 + x^4 + x^2 + x + 1$	CRC-32 (used in Ethernet)
64 bit	$x^{64} + x^4 + x^3 + x + 1$	CRC-64-ISO (HDLC)

NOTE:

Device SPI protocol Limitation: The CRC length of the message or Async-event shall be multiple of 4 bytes to enable reliable retry recovery mechanism in case of any checksum failure in a message.

3 Message Processing

3.1 Communication protocol

When requested by the message transmitter, all correctly formatted radar messages are acknowledged by the receiver. This request for an acknowledgement is specified in FLAGS field of the MSGHDR (message header) field (see Section 2.3.2). A correctly formatted message is one that is formatted properly with a SYNC, MSGHDR, MSGDATA and CRC and that passes the CRC test when received. If an incorrectly formatted message is received, the radar device responds with a NACK message (MSGTYPE field in the MSGHDR set to NACK response). If a correctly formatted message is received, and after processing the message no errors are encountered, the radar device responds with an ACK response. In case of errors on a correctly formatted message, the radar device responds with an ERROR response.

The ACK response is a radar message which contains SYNC, MSGHDR, MSGDATA and CRC. In case the MSGTYPE was COMMAND_GET the MSGDATA for ACK response will contain the parameter values read by the radar device.

The NACK response is a radar message with only SYNC, MSGHDR and CRC. It does not contain MSGDATA.

For most commands the radar device prepares the acknowledgments and response packets immediately on reception. In certain cases, higher priority events in the system delay the execution of external communication function. The response time to command is a function of:

- Speed of the selected communication channel
- Although typical radar command/response occurs within a few hundreds of microseconds, it is recommended that host software wait up to 1 millisecond for response or acknowledgment before timing out on nonresponse.

The radar communication protocol is defined as follows

1. The host sends a message to the radar device requesting an acknowledgement. Host sets a timeout period of 1 ms for a response from the radar device.
2. The radar device checks the CHKSUM field for Message header validity and checks the MSGDATA field for correctness and also computes the CRC of the message and compares it with the received CRC.
 - If the computed CHKSUM does not match the received CHKSUM, the radar device does not send any response. The transmitter will timeout and eventually resend the command again with RETRY flag set

- If the CRC matches and all parameters are valid/correct, the radar device sends an ACK to the host
 - If the CRC matches, but any parameter in the message is invalid/incorrect, then the radar device sends an ERROR response to the host
 - If the CRC does not match, the radar device sends a NACK response to the host
3. On reception of the ACK, the host can send the next command to the radar device.
 4. If the host receives a NACK from the radar device within the timeout period, it sends the message again without the RETRY flag set.
 5. If the host does not receive any response from the radar device within the timeout period then it sends the same command with the RETRY flag set.

3.2 Communication Sequence

3.2.1 Command/Response Sequence (Host)

1. Host prepares the message as defined by protocol in Section 2.3
2. Host writes the message to the communication channel and starts Retry Timer (~1 ms)
3. Host then waits for HOST IRQ high Interrupt
 - a. If IRQ is received, go to Step 4
 - b. If Retry Time expires, Enable Retry Flag and go to Step 2
4. Host writes CNYS (SYNC word = 0x5678 0x8765) and Dummy bytes (0xFFFF 0xFFFF 0xFFFF 0xFFFF 0xFFFF 0xFFFF) on communication channel
5. Host waits for low on Host IRQ line
 - a. If Host IRQ line is low, go to Step 6
 - b. If Retry Time expires, Flag Error
6. Host reads the header from communication channel
7. Host checks the validity of header (verify checksum)
 - a. If header is valid, parse the header and go to Step 8
 - b. If header is invalid, ignore the header and reports to error to Application
8. Host reads the payload from communication channel
9. Host checks the validity of the message (verify CRC)
 - a. If message is valid, process the message
 - b. If message is invalid, go to Step 2 with new sequence number

3.2.2 Flow Diagram (Host) – Command/Response

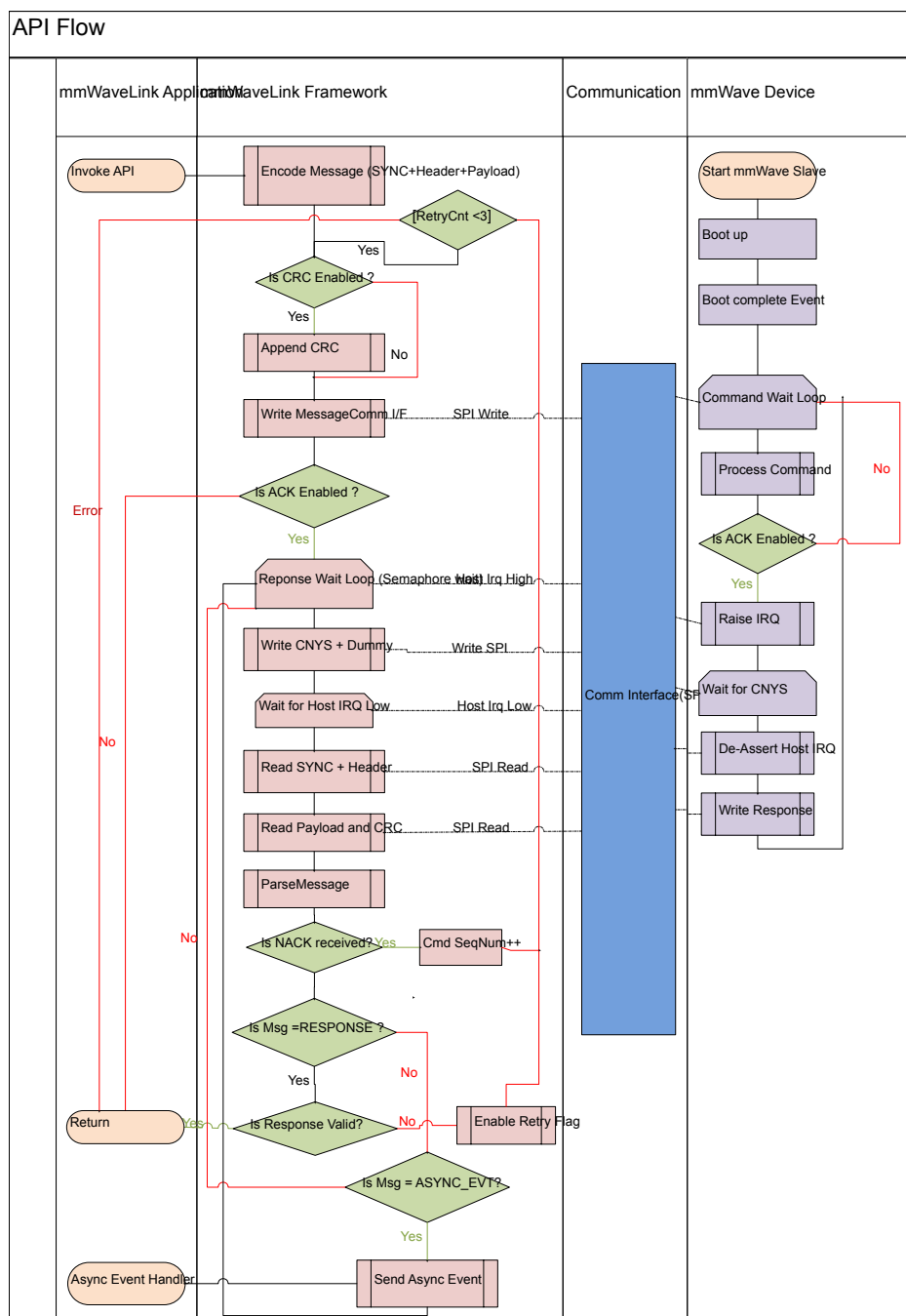

Figure 3.1: Flow Diagram (API)

3.2.3 Flow Diagram (Host) – Bootup/ Asynchronous Event

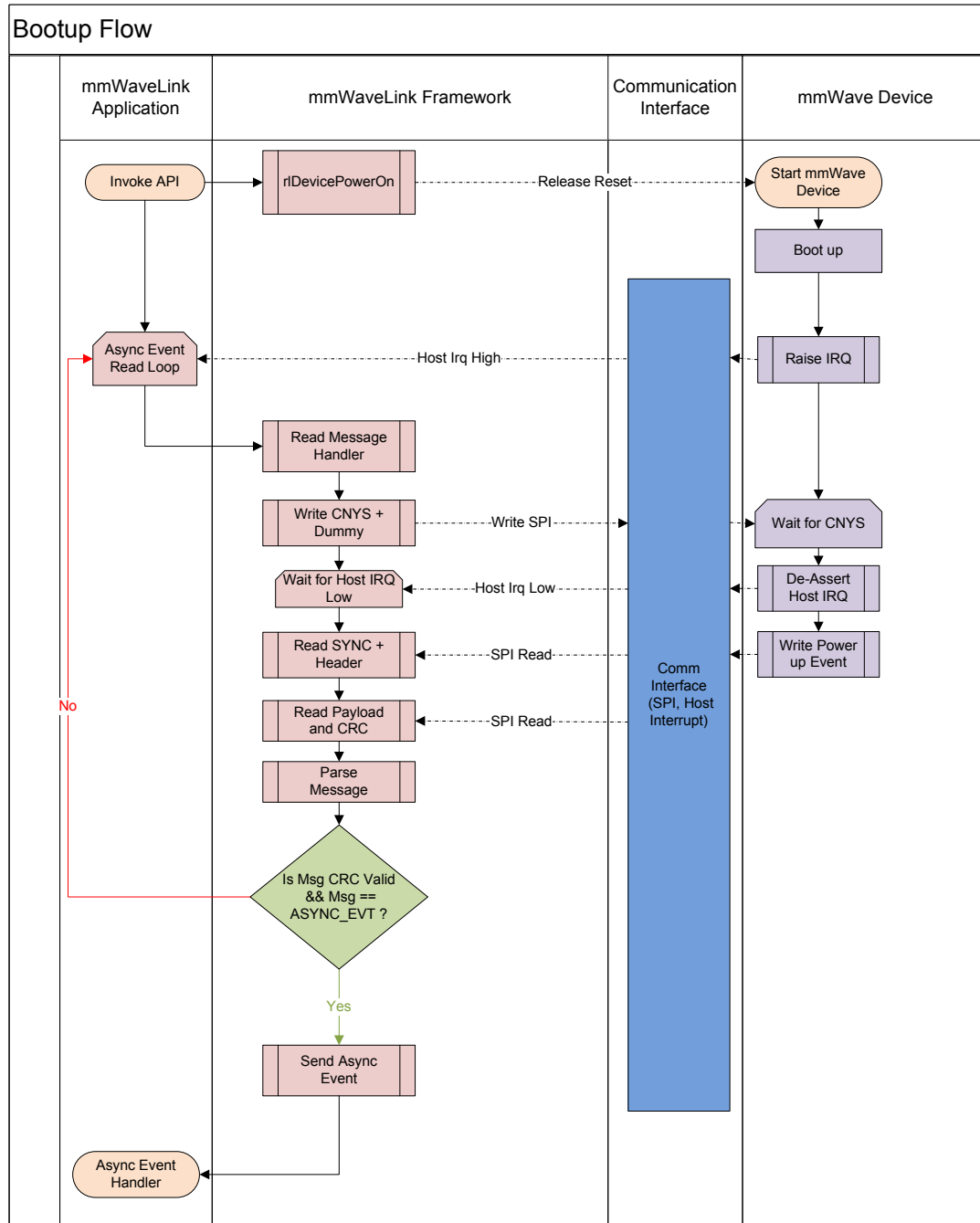

Figure 3.2: Flow Diagram (Asynchronous Events)

3.2.4 SPI Message Sequence – Command/Response

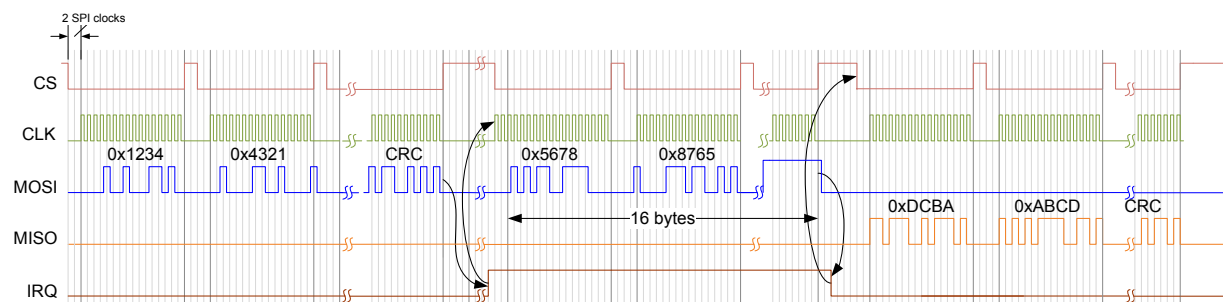

Figure 3.3: SPI Message Sequence

NOTE:

1. Host should ensure that there is a delay of at least 2 SPI clocks between CS going low and start of SPI clock
2. Host should ensure that CS is toggled for every 16 bits of transfer via SPI
3. There should be a delay of at least 2 SPI Clocks between consecutive CS
4. SPI needs to be operated at Mode 0 (Phase 1, Polarity 0)
5. SPI word length should be 16 bit (Half word)

**Application
Care Abouts:**

1. Retry of RF Power up message is unsupported.
2. HOST is recommended to wait for RF Power Async msg before any further APIs are issued. Lack of RF Power up Async msg should be treated as bootup failure.
3. It is recommended to wait for Async event for Latent fault injection API before the next CMD is issued.
4. HOST to ensure a delay of 30us in response to the HOST_IRQ interrupt, to allow for a SPI DMA configuration in device post HOST_IRQ set high.
5. It is recommended to use 232 as the chunk size in mmWavelink/HOST when firmware download is done through SPI.

4 Radar Interface Messages Descriptions

This section describes all the radar interface messages that are used in communication with the radar transceiver.

4.1 Summary of all messages and their associated sub-blocks

Table 4.1: Summary of all Radar messages and their associated sub blocks

Radar Messages	Associated sub-blocks
AWR_ACK_MSG	NA
AWR_NACK_MSG	NA
AWR_ERROR_MSG	AWR_RESP_ERROR_SB
AWR_RF_STATIC_CONF_SET_MSG	AWR_CHAN_CONF_SET_SB AWR_ADCOUT_CONF_SET_SB AWR_LOWPOWERMODE_CONF_SET_SB AWR_DYNAMICPOWERSAVE_CONF_SET_SB AWR_HIGHSPEEDINTFCLK_CONF_SET_SB AWR_RF_DEVICE_CFG_SB AWR_RF_RADAR_MISC_CTL_SB AWR_CAL_MON_FREQUENCY_LIMITS_SB AWR_RF_INIT_CALIBRATION_CONF_SB AWR_CAL_MON_FREQUENCY_TX_POWER_LIMITS_SB AWR_CAL_DATA_RESTORE_SB AWR_PHASE_SHIFTER_CAL_DATA_RESTORE_SB AWR_APLL_SYNTH_BW_CONTROL_SB
AWR_RF_STATIC_CONF_GET_MSG	AWR_CAL_DATA_SAVE_SB AWR_PHASE_SHIFTER_CAL_DATA_SAVE_SB
AWR_RF_INIT_MSG	AWR_RF_INIT_SB
AWR_RF_DYNAMIC_CONF_SET_MSG	AWR_PROFILE_CONF_SET_SB AWR_CHIRP_CONF_SET_SB AWR_FRAME_CONF_SET_SB

Continued on next page

Table 4.1 – continued from previous page

Radar Messages	Associated sub-blocks
	AWR_CONT_STREAMING_MODE_CONF_SET_SB AWR_CONT_STREAMING_MODE_EN_SB AWR_ADVANCED_FRAME_CONF_SB AWR_PERCHIRPPHASESHIFT_CONF_SB AWR_PROG_FILT_COEFF_RAM_SET_SB AWR_PROG_FILT_CONF_SET_SB AWR_CALIB_MON_TIME_UNIT_CONF_SB AWR_RUN_TIME_CALIBRATION_CONF_AND_TRIGGER_SB AWR_INTER_RX_GAIN_PHASE_CONTROL_SB AWR_RX_GAIN_TEMPLUT_SET_SB AWR_TX_GAIN_TEMPLUT_SET_SB AWR_LOOPBACK_BURST_CONF_SET_SB AWR_DYN_CHIRP_CONF_SET_SB AWR_DYN_PERCHIRP_PHASESHIFTER_CONF_SB AWR_DYN_CHIRP_ENABLE_SB AWR_INTERCHIRP_BLOCKCONTROLS_SB AWR_SUBFRAME_START_CONF_SB
AWR_RF_DYNAMIC_CONF_GET_MSG	AWR_PROFILE_CONF_GET_SB AWR_CHIRP_CONF_GET_SB AWR_FRAME_CONF_GET_SB AWR_ADVANCED_FRAME_CONF_GET_SB AWR_RX_GAIN_TEMPLUT_GET_SB AWR_TX_GAIN_TEMPLUT_GET_SB
AWR_RF_FRAME_TRIG_MSG	AWR_FRAMESTARTSTOP_CONF_SB
AWR_RF_ADVANCED_FEATURES_CONF_SET_MSG	AWR_BPM_COMMON_CONF_SET_SB AWR_BPM_CHIRP_CONF_SET_SB AWR_POWER_SAVE_MODE_CONF_SET_SB
AWR_RF_MONITORING_CONF_SET_MSG	AWR_MONITOR_RF_DIG_LATENTFAULT_CONF_SB AWR_MONITOR_RF_DIG_PERIODIC_CONF_SB AWR_MONITOR_ANALOG_ENABLES_CONF_SB AWR_MONITOR_TEMPERATURE_CONF_SB AWR_MONITOR_RX_GAIN_PHASE_CONF_SB AWR_MONITOR_RX_NOISE_FIGURE_CONF_SB AWR_MONITOR_RX_IFSTAGE_CONF_SB

Continued on next page

Table 4.1 – continued from previous page

Radar Messages	Associated sub-blocks
	AWR_MONITOR_TX0_POWER_CONF_SB AWR_MONITOR_TX1_POWER_CONF_SB AWR_MONITOR_TX2_POWER_CONF_SB AWR_MONITOR_TX0_BALLBREAK_CONF_SB AWR_MONITOR_TX1_BALLBREAK_CONF_SB AWR_MONITOR_TX2_BALLBREAK_CONF_SB AWR_MONITOR_TX_GAIN_PHASE_MISMATCH_CONF_SB AWR_MONITOR_TX0_BPM_CONF_SB AWR_MONITOR_TX1_BPM_CONF_SB AWR_MONITOR_TX2_BPM_CONF_SB AWR_MONITOR_SYNTHESIZER_FREQUENCY_CONF_SB AWR_MONITOR_EXTERNAL_ANALOG_SIGNALS_CONF_SB AWR_MONITOR_TX0_INTERNAL_ANALOG_SIGNALS_CONF_SB AWR_MONITOR_TX1_INTERNAL_ANALOG_SIGNALS_CONF_SB AWR_MONITOR_TX2_INTERNAL_ANALOG_SIGNALS_CONF_SB AWR_MONITOR_RX_INTERNAL_ANALOG_SIGNALS_CONF_SB AWR_MONITOR_PMCLKLO_INTERNAL_ANALOG_SIGNALS_CONF_SB AWR_MONITOR_GPADC_INTERNAL_ANALOG_SIGNALS_CONF_SB AWR_MONITOR_PLL_CONTROL_VOLTAGE_SIGNALS_CONF_SB AWR_MONITOR_DUAL_CLOCK_COMP_CONF_SB AWR_MONITOR_RX_SATURATION_DETECTOR_CONF_SB AWR_MONITOR_SIG_IMG_MONITOR_CONF_SB AWR_MONITOR_RX_MIXER_IN_POWER_CONF_SB AWR_ANALOG_FAULT_INJECTION_CONF_SB
AWR_RF_MONITORING_REPORT_GET_MSG	AWR_RF_DFE_STATISTICS_REPORT_GET_SB
AWR_RF_STATUS_GET_MSG	AWR_RF_VERSION_GET_SB AWR_RF_CPUFAULT_STATUS_GET_SB AWR_RF_ESMFAULT_STATUS_GET_SB

Continued on next page

Table 4.1 – continued from previous page

Radar Messages	Associated sub-blocks
	AWR_RF_DIEID_GET_SB AWR_RF_BOOTUPBIST_STATUS_GET_SB
AWR_RF_MISC_CONF_SET_MSG	AWR_RF_TEST_SOURCE_CONFIG_SET_SB AWR_RF_TEST_SOURCE_ENABLE_SET_SB AWR_RF_LDO_BYPASS_SB AWR_RF_PALOOPBACK_CFG_SB AWR_RF_PSLOOPBACK_CFG_SB AWR_RF_IFLOOPBACK_CFG_SB AWR_RF_GPADC_CFG_SET_SB
AWR_RF_MISC_CONF_GET_MSG	AWR_RF_TEMPERATURE_GET_SB
AWR_RF_ASYNC_EVENT_MSG1	AWR_AE_RF_CPUFAULT_SB AWR_AE_RF_ESMFAULT_SB AWR_AE_RF_INITCALIBSTATUS_SB AWR_AE_RF_FRAME_TRIGGER_RDY_SB AWR_AE_RF_GPADC_RESULT_DATA_SB AWR_FRAME_END_AE_SB AWR_ANALOGFAULT_AE_SB AWR_CAL_MON_TIMING_FAIL_REPORT_AE_SB AWR_RUN_TIME_CALIBRATION_SUMMARY_REPORT_AE_SB AWR_MONITOR_RF_DIG_LATENTFAULT_REPORT_AE_SB AWR_MONITOR_REPORT_HEADER_AE_SB AWR_MONITOR_RF_DIG_PERIODIC_REPORT_AE_SB AWR_MONITOR_TEMPERATURE_REPORT_AE_SB AWR_MONITOR_RX_GAIN_PHASE_REPORT_AE_SB AWR_MONITOR_RX_NOISE_FIGURE_REPORT_AE_SB AWR_MONITOR_RX_IFSTAGE_REPORT_AE_SB AWR_MONITOR_TX0_POWER_REPORT_AE_SB AWR_MONITOR_TX1_POWER_REPORT_AE_SB AWR_MONITOR_TX2_POWER_REPORT_AE_SB AWR_MONITOR_TX0_BALLBREAK_REPORT_AE_SB AWR_MONITOR_TX1_BALLBREAK_REPORT_AE_SB
	AWR_MONITOR_TX2_BALLBREAK_REPORT_AE_SB AWR_MONITOR_TX_GAIN_PHASE_MISMATCH_REPORT_AE_SB

Continued on next page

Table 4.1 – continued from previous page

Radar Messages	Associated sub-blocks
	AWR_MONITOR_TX0_BPM_REPORT_AE_SB AWR_MONITOR_TX1_BPM_REPORT_AE_SB AWR_MONITOR_TX2_BPM_REPORT_AE_SB AWR_MONITOR_SYNTHESIZER_FREQUENCY_REPORT_AE_SB AWR_MONITOR_EXTERNAL_ANALOG_SIGNALSREPORT_AE_SB AWR_MONITOR_TX0_INTERNAL_ANALOG_SIGNALS_REPORT_AE_SB AWR_MONITOR_TX1_INTERNAL_ANALOG_SIGNALS_REPORT_AE_SB AWR_MONITOR_TX2_INTERNAL_ANALOG_SIGNALS_REPORT_AE_SB AWR_MONITOR_RX_INTERNAL_ANALOG_SIGNALS_REPORT_AE_SB AWR_MONITOR_PMCLKLO_INTERNAL_ANALOG_SIGNALS_REPORT_AE_SB AWR_MONITOR_GPADC_INTERNAL_ANALOG_SIGNALS_REPORT_AE_SB AWR_MONITOR_PLL_CONTROL_VOLTAGE_REPORT_AE_SB AWR_MONITOR_DUAL_CLOCK_COMP_REPORT_AE_SB AWR_MONITOR_RX_MIXER_IN_POWER_REPORT_AE_SB AWR_MONITOR_SYNTHESIZER_FREQUENCY_NONLIVE_REPORT_AE_SB
AWR_DEV_RFPOWERUP_MSG	AWR_DEV_RFPOWERUP_SB
AWR_DEV_CONF_SET_MSG	AWR_DEV_MCUCLOCK_CONF_SET_SB AWR_DEV_RX_DATA_FORMAT_CONF_SET_SB AWR_DEV_RX_DATA_PATH_CONF_SET_SB AWR_DEV_RX_DATA_PATH_LANEEN_SET_SB AWR_DEV_RX_DATA_PATH_CLK_SET_SB AWR_DEV_LVDS_CFG_SET_SB AWR_DEV_RX_CONTSTREAMING_MODE_CONF_SET_SB AWR_DEV_CSI2_CFG_SET_SB AWR_DEV_PMICCLOCK_CONF_SET_SB AWR_MSS_LATENTFAULT_TEST_CONF_SB AWR_MSS_PERIODICTESTS_CONF_SB

Continued on next page

Table 4.1 – continued from previous page

Radar Messages	Associated sub-blocks
	AWR_DEV_TESTPATTERN_GEN_SET_SB AWR_DEV_CONFIGURATION_SET_SB
AWR_DEV_CONF_GET_MSG	AWR_DEV_MCUCLOCK_GET_SB AWR_DEV_RX_DATA_FORMAT_CONF_GET_SB AWR_DEV_RX_DATA_PATH_CONF_GET_SB AWR_DEV_RX_DATA_PATH_LANEEN_GET_SB AWR_DEV_RX_DATA_PATH_CLK_GET_SB AWR_DEV_LVDS_CFG_GET_SB AWR_DEV_RX_CONTSTREAMING_MODE_CONF_GET_SB AWR_DEV_CSI2_CFG_GET_SB AWR_DEV_PMICCLOCK_CONF_GET_SB AWR_MSS_LATENTFAULT_TEST_CONF_GET_SB AWR_MSS_PERIODICCONF_GET_SB AWR_DEV_TESTPATTERN_GEN_GET_SB
AWR_DEV_FILE_DOWNLOAD_MSG	AWR_DEV_FILE_DOWNLOAD_SB
AWR_DEV_FRAME_CONFIG_APPLY_MSG	AWR_DEV_FRAME_CONFIG_APPLY_SB AWR_DEV_ADV_FRAME_CONFIG_APPLY_SB
AWR_DEV_STATUS_GET_MSG	AWR_MSSVERSION_GET_SB AWR_MSSCPUFAULT_STATUS_GET_SB AWR_MSSSEMFault_STATUS_GET_SB
AWR_DEV_ASYNC_EVENT_MSG	AWR_AE_DEV_MSSPOWERUPDONE_SB AWR_AE_DEV_RFPOWERUPDONE_SB AWR_AE_MSS_CPUFAULT_SB AWR_AE_MSS_ESMFAULT_SB AWR_AE_MSS_BOOTERRORSTATUS_SB AWR_AE_MSS_LATENTFAULT_TESTREPORT_SB AWR_AE_MSS_PERIODICTEST_STATUS_SB AWR_AE_MSS_RFERROR_STATUS_SB AWR_AE_MSS_VMON_ERRORSTATUS_SB AWR_AE_MSS_ADC_DATA_SB

4.2 AWR_ACK_MSG

The AWR_ACK_MSG is sent by the radar transceiver on a successful reception of a command after its CRC check.

Field Name	Number of bytes	Description												
SYNC	4	Value = 0xABCDDCBA												
OPCODE	2	<table border="0"> <tr> <td>Bits</td> <td>Variable name</td> <td>Value</td> </tr> <tr> <td>b3:0</td> <td>DIRECTION</td> <td>See Table 2.2</td> </tr> <tr> <td>b5:4</td> <td>MSGTYPE</td> <td>01</td> </tr> <tr> <td>b15:6</td> <td>MSGID</td> <td>Same as MSGID in the command</td> </tr> </table>	Bits	Variable name	Value	b3:0	DIRECTION	See Table 2.2	b5:4	MSGTYPE	01	b15:6	MSGID	Same as MSGID in the command
Bits	Variable name	Value												
b3:0	DIRECTION	See Table 2.2												
b5:4	MSGTYPE	01												
b15:6	MSGID	Same as MSGID in the command												
MSGLEN	2	Length of the message in bytes (do not include sync length)												
FLAGS	2	See Section 2.3.2												
REMCHUNKS	2	Value = 0												
NSBC	2	Number of sub blocks contained in the message												
CHKSUM	2	See Section 2.3.2												
CRC	Variable	Based on CRCLen field in FLAGS												

4.3 AWR_NACK_MSG

The AWR_NACK_MSG is sent by the radar transceiver if the CRC check of the command fails.

Field Name	Number of bytes	Description												
SYNC	4	Value = 0xABCDDCBA												
OPCODE	2	<table border="0"> <tr> <td>Bits</td> <td>Variable name</td> <td>Value</td> </tr> <tr> <td>b3:0</td> <td>DIRECTION</td> <td>See Table 2.2</td> </tr> <tr> <td>b5:4</td> <td>MSGTYPE</td> <td>10</td> </tr> <tr> <td>b15:6</td> <td>MSGID</td> <td>Same as MSGID in the command</td> </tr> </table>	Bits	Variable name	Value	b3:0	DIRECTION	See Table 2.2	b5:4	MSGTYPE	10	b15:6	MSGID	Same as MSGID in the command
Bits	Variable name	Value												
b3:0	DIRECTION	See Table 2.2												
b5:4	MSGTYPE	10												
b15:6	MSGID	Same as MSGID in the command												
MSGLEN	2	Length of the message in bytes (do not include sync length)												
FLAGS	2	See Section 2.3.2												
REMCHUNKS	2	Value = 0												
NSBC	2	Number of sub blocks contained in the message												

CHKSUM	2	See Section 2.3.2
CRC	Variable	Based on CRCLLEN field in FLAGS

4.4 AWR_ERROR_MSG

The AWR_RF_ERROR_MSG is sent by the radar transceiver on finding errors in the command send by host.

Field Name	Number of bytes	Description												
SYNC	4	Value = 0xABCDDCBA												
OPCODE	2	<table border="0"> <tr> <td>Bits</td> <td>Variable name</td> <td>Value</td> </tr> <tr> <td>b3:0</td> <td>DIRECTION</td> <td>See Table 2.2</td> </tr> <tr> <td>b5:4</td> <td>MSGTYPE</td> <td>01</td> </tr> <tr> <td>b15:6</td> <td>MSGID</td> <td>0x00</td> </tr> </table>	Bits	Variable name	Value	b3:0	DIRECTION	See Table 2.2	b5:4	MSGTYPE	01	b15:6	MSGID	0x00
Bits	Variable name	Value												
b3:0	DIRECTION	See Table 2.2												
b5:4	MSGTYPE	01												
b15:6	MSGID	0x00												
MSGLEN	2	Length of the message in bytes (do not include sync length)												
FLAGS	2	See Section 2.3.2												
REMCHUNKS	2	Value = 0												
NSBC	2	Number of sub blocks contained in the message												
CHKSUM	2	See Section 2.3.2												
MSGDATA	Variable	Supported sub blocks AWR_RESP_ERROR_SB												
CRC	Variable	Based on CRCLLEN field in FLAGS												

4.5 AWR_RF_STATIC_CONF_SET_MSG

Field Name	Number of bytes	Description												
SYNC	4	Value = 0x43211234												
OPCODE	2	<table border="0"> <tr> <td>Bits</td> <td>Variable name</td> <td>Value</td> </tr> <tr> <td>b3:0</td> <td>DIRECTION</td> <td>See Table 2.2</td> </tr> <tr> <td>b5:4</td> <td>MSGTYPE</td> <td>00</td> </tr> <tr> <td>b15:6</td> <td>MSGID</td> <td>0x04</td> </tr> </table>	Bits	Variable name	Value	b3:0	DIRECTION	See Table 2.2	b5:4	MSGTYPE	00	b15:6	MSGID	0x04
Bits	Variable name	Value												
b3:0	DIRECTION	See Table 2.2												
b5:4	MSGTYPE	00												
b15:6	MSGID	0x04												

MSGLEN	2	Length of the message in bytes (do not include sync length)
FLAGS	2	See Section 2.3.2
REMCHUNKS	2	Value = 0
NSBC	2	Number of sub blocks contained in the message
CHKSUM	2	See Section 2.3.2
MSGDATA	Variable	Supported sub blocks AWR_CHAN_CONF_SET_SB AWR_ADCOUT_CONF_SET_SB AWR_LOWPPOWERMODE_CONF_SET_SB AWR_DYNAMICPOWERSAVE_CONF_SET_SB AWR_HIGHSPEEDINTFCLK_CONF_SET_SB AWR_RF_DEVICE_CFG_SB AWR_RF_RADAR_MISC_CTL_SB AWR_CAL_MON_FREQUENCY_LIMITS_SB AWR_RF_INIT_CALIBRATION_CONF_SB AWR_CAL_MON_FREQUENCY_TX_POWER_LIMITS_SB AWR_CAL_DATA_RESTORE_SB AWR_PHASE_SHIFTER_CAL_DATA_RESTORE_SB AWR_APLL_SYNTH_BW_CONTROL_SB
CRC	Variable	Based on CRCLen field in FLAGS

4.6 AWR_RF_STATIC_CONF_GET_MSG

Field Name	Number of bytes	Description												
SYNC	4	Value = 0x43211234												
OPCODE	2	<table border="1"> <thead> <tr> <th>Bits</th> <th>Variable name</th> <th>Value</th> </tr> </thead> <tbody> <tr> <td>b3:0</td> <td>DIRECTION</td> <td>See Table 2.2</td> </tr> <tr> <td>b5:4</td> <td>MSGTYPE</td> <td>00</td> </tr> <tr> <td>b15:6</td> <td>MSGID</td> <td>0x05</td> </tr> </tbody> </table>	Bits	Variable name	Value	b3:0	DIRECTION	See Table 2.2	b5:4	MSGTYPE	00	b15:6	MSGID	0x05
Bits	Variable name	Value												
b3:0	DIRECTION	See Table 2.2												
b5:4	MSGTYPE	00												
b15:6	MSGID	0x05												

MSGLEN	2	Length of the message in bytes (do not include sync length)
FLAGS	2	See Section 2.3.2
REMCHUNKS	2	Value = 0
NSBC	2	Number of sub blocks contained in the message
CHKSUM	2	See Section 2.3.2
MSGDATA	Variable	Supported sub blocks AWR_CAL_DATA_SAVE_SB AWR_PHASE_SHIFTER_CAL_DATA_SAVE_SB
CRC	Variable	Based on CRCLLEN field in FLAGS

4.7 AWR_RF_INIT_MSG

Field Name	Number of bytes	Description
SYNC	4	Value = 0x43211234
OPCODE	2	Bits Variable name Value b3:0 DIRECTION See Table 2.2 b5:4 MSGTYPE 00 b15:6 MSGID 0x06
MSGLEN	2	Length of the message in bytes (do not include sync length)
FLAGS	2	See Section 2.3.2
REMCHUNKS	2	Value = 0
NSBC	2	Number of sub blocks contained in the message
CHKSUM	2	See Section 2.3.2
MSGDATA	Variable	Supported sub blocks AWR_RF_INIT_SB
CRC	Variable	Based on CRCLLEN field in FLAGS

4.8 AWR_RF_DYNAMIC_CONF_SET_MSG

Field Name	Number of bytes	Description
------------	-----------------	-------------

SYNC	4	Value = 0x43211234												
OPCODE	2	<table border="1"> <thead> <tr> <th>Bits</th> <th>Variable name</th> <th>Value</th> </tr> </thead> <tbody> <tr> <td>b3:0</td> <td>DIRECTION</td> <td>See Table 2.2</td> </tr> <tr> <td>b5:4</td> <td>MSGTYPE</td> <td>00</td> </tr> <tr> <td>b15:6</td> <td>MSGID</td> <td>0x08</td> </tr> </tbody> </table>	Bits	Variable name	Value	b3:0	DIRECTION	See Table 2.2	b5:4	MSGTYPE	00	b15:6	MSGID	0x08
Bits	Variable name	Value												
b3:0	DIRECTION	See Table 2.2												
b5:4	MSGTYPE	00												
b15:6	MSGID	0x08												
MSGLEN	2	Length of the message in bytes (do not include sync length)												
FLAGS	2	See Section 2.3.2												
REMCHUNKS	2	Value = 0												
NSBC	2	Number of sub blocks contained in the message												
CHKSUM	2	See Section 2.3.2												
MSGDATA	Variable	Supported sub blocks AWR_PROFILE_CONF_SET_SB AWR_CHIRP_CONF_SET_SB AWR_FRAME_CONF_SET_SB AWR_CONT_STREAMING_MODE_CONF_SET_SB AWR_CONT_STREAMING_MODE_EN_SB AWR_ADVANCED_FRAME_CONF_SB AWR_PERCHIRPPHASESHIFT_CONF_SB AWR_PROG_FILT_COEFF_RAM_SET_SB AWR_PROG_FILT_CONF_SET_SB AWR_CALIB_MON_TIME_UNIT_CONF_SB AWR_RUN_TIME_CALIBRATION_CONF_AND_TRIGGER_SB AWR_INTER_RX_GAIN_PHASE_CONTROL_SB AWR_RX_GAIN_TEMPLUT_SET_SB AWR_TX_GAIN_TEMPLUT_SET_SB AWR_LOOPBACK_BURST_CONF_SET_SB AWR_DYN_CHIRP_CONF_SET_SB AWR_DYN_PERCHIRP_PHASESHIFTER_CONF_SB AWR_DYN_CHIRP_ENABLE_SB AWR_INTERCHIRP_BLOCKCONTROLS_SB AWR_SUBFRAME_START_CONF_SB												
CRC	Variable	Based on CRCLLEN field in FLAGS												

4.9 AWR_RF_DYNAMIC_CONF_GET_MSG

Field Name	Number of bytes	Description												
SYNC	4	Value = 0x43211234												
OPCODE	2	<table border="0"> <tr> <td>Bits</td> <td>Variable name</td> <td>Value</td> </tr> <tr> <td>b3:0</td> <td>DIRECTION</td> <td>See Table 2.2</td> </tr> <tr> <td>b5:4</td> <td>MSGTYPE</td> <td>00</td> </tr> <tr> <td>b15:6</td> <td>MSGID</td> <td>0x09</td> </tr> </table>	Bits	Variable name	Value	b3:0	DIRECTION	See Table 2.2	b5:4	MSGTYPE	00	b15:6	MSGID	0x09
Bits	Variable name	Value												
b3:0	DIRECTION	See Table 2.2												
b5:4	MSGTYPE	00												
b15:6	MSGID	0x09												
MSGLEN	2	Length of the message in bytes (do not include sync length)												
FLAGS	2	See Section 2.3.2												
REMCHUNKS	2	Value = 0												
NSBC	2	Number of sub blocks contained in the message												
CHKSUM	2	See Section 2.3.2												
MSGDATA	Variable	Supported sub blocks AWR_PROFILE_CONF_GET_SB AWR_CHIRP_CONF_GET_SB AWR_FRAME_CONF_GET_SB AWR_ADVANCED_FRAME_CONF_GET_SB AWR_RX_GAIN_TEMPLUT_GET_SB AWR_TX_GAIN_TEMPLUT_GET_SB												
CRC	Variable	Based on CRCLEN field in FLAGS												

4.10 AWR_RF_FRAME_TRIG_MSG

Field Name	Number of bytes	Description												
SYNC	4	Value = 0x43211234												
OPCODE	2	<table border="0"> <tr> <td>Bits</td> <td>Variable name</td> <td>Value</td> </tr> <tr> <td>b3:0</td> <td>DIRECTION</td> <td>See Table 2.2</td> </tr> <tr> <td>b5:4</td> <td>MSGTYPE</td> <td>00</td> </tr> <tr> <td>b15:6</td> <td>MSGID</td> <td>0x0A</td> </tr> </table>	Bits	Variable name	Value	b3:0	DIRECTION	See Table 2.2	b5:4	MSGTYPE	00	b15:6	MSGID	0x0A
Bits	Variable name	Value												
b3:0	DIRECTION	See Table 2.2												
b5:4	MSGTYPE	00												
b15:6	MSGID	0x0A												
MSGLEN	2	Length of the message in bytes (do not include sync length)												
FLAGS	2	See Section 2.3.2												
REMCHUNKS	2	Value = 0												

NSBC	2	Number of sub blocks contained in the message
CHKSUM	2	See Section 2.3.2
MSGDATA	Variable	Supported sub blocks AWR_FRAMESTARTSTOP_CONF_SB
CRC	Variable	Based on CRCLLEN field in FLAGS

4.11 AWR_RF_ADVANCED_FEATURES_CONF_SET_MSG

Field Name	Number of bytes	Description												
SYNC	4	Value = 0x43211234												
OPCODE	2	<table border="0"> <tr> <td>Bits</td> <td>Variable name</td> <td>Value</td> </tr> <tr> <td>b3:0</td> <td>DIRECTION</td> <td>See Table 2.2</td> </tr> <tr> <td>b5:4</td> <td>MSGTYPE</td> <td>00</td> </tr> <tr> <td>b15:6</td> <td>MSGID</td> <td>0x0C</td> </tr> </table>	Bits	Variable name	Value	b3:0	DIRECTION	See Table 2.2	b5:4	MSGTYPE	00	b15:6	MSGID	0x0C
Bits	Variable name	Value												
b3:0	DIRECTION	See Table 2.2												
b5:4	MSGTYPE	00												
b15:6	MSGID	0x0C												
MSGLEN	2	Length of the message in bytes (do not include sync length)												
FLAGS	2	See Section 2.3.2												
REMCHUNKS	2	Value = 0												
NSBC	2	Number of sub blocks contained in the message												
CHKSUM	2	See Section 2.3.2												
MSGDATA	Variable	Supported sub blocks AWR_BPM_COMMON_CONF_SET_SB AWR_BPM_CHIRP_CONF_SET_SB AWR_POWER_SAVE_MODE_CONF_SET_SB												
CRC	Variable	Based on CRCLLEN field in FLAGS												

4.12 AWR_RF_MONITORING_CONF_SET_MSG

Field Name	Number of bytes	Description												
SYNC	4	Value = 0x43211234												
OPCODE	2	<table border="1"> <thead> <tr> <th>Bits</th> <th>Variable name</th> <th>Value</th> </tr> </thead> <tbody> <tr> <td>b3:0</td> <td>DIRECTION</td> <td>See Table 2.2</td> </tr> <tr> <td>b5:4</td> <td>MSGTYPE</td> <td>00</td> </tr> <tr> <td>b15:6</td> <td>MSGID</td> <td>0x0E</td> </tr> </tbody> </table>	Bits	Variable name	Value	b3:0	DIRECTION	See Table 2.2	b5:4	MSGTYPE	00	b15:6	MSGID	0x0E
Bits	Variable name	Value												
b3:0	DIRECTION	See Table 2.2												
b5:4	MSGTYPE	00												
b15:6	MSGID	0x0E												
MSGLEN	2	Length of the message in bytes (do not include sync length)												
FLAGS	2	See Section 2.3.2												
REMCHUNKS	2	Value = 0												
NSBC	2	Number of sub blocks contained in the message												
CHKSUM	2	See Section 2.3.2												
MSGDATA	Variable	Supported sub blocks AWR_MONITOR_RF_DIG_LATENTFAULT_CONF_SB AWR_MONITOR_RF_DIG_PERIODIC_CONF_SB AWR_MONITOR_ANALOG_ENABLES_CONF_SB AWR_MONITOR_TEMPERATURE_SONF_SB AWR_MONITOR_RX_GAIN_PHASE_CONF_SB AWR_MONITOR_RX_NOISE_FIGURE_CONF_SB AWR_MONITOR_RX_IFSTAGE_CONF_SB AWR_MONITOR_TX0_POWER_CONF_SB AWR_MONITOR_TX1_POWER_CONF_SB AWR_MONITOR_TX2_POWER_CONF_SB AWR_MONITOR_TX0_BALLBREAK_CONF_SB AWR_MONITOR_TX1_BALLBREAK_CONF_SB AWR_MONITOR_TX2_BALLBREAK_CONF_SB AWR_MONITOR_TX_GAIN_PHASE_MISMATCH_CONF_SB AWR_MONITOR_TX0_BPM_CONF_SB AWR_MONITOR_TX1_BPM_CONF_SB AWR_MONITOR_TX2_BPM_CONF_SB AWR_MONITOR_SYNTHESIZER_FREQUENCY_CONF_SB AWR_MONITOR_EXTERNAL_ANALOG_SIGNALS_CONF_SB AWR_MONITOR_TX0_INTERNAL_ANALOG_SIGNALS_CONF_SB												

		AWR_MONITOR_TX1_INTERNAL_ANALOG_SIGNALS_CONF_SB AWR_MONITOR_TX2_INTERNAL_ANALOG_SIGNALS_CONF_SB AWR_MONITOR_RX_INTERNAL_ANALOG_SIGNALS_CONF_SB AWR_MONITOR_PMCLKLO_INTERNAL_ANALOG_SIGNALS_CONF_SB AWR_MONITOR_GPADC_INTERNAL_ANALOG_SIGNALS_CONF_SB AWR_MONITOR_PLL_CONTROL_VOLTAGE_SIGNALS_CONF_SB AWR_MONITOR_DUAL_CLOCK_COMP_CONF_SB AWR_MONITOR_RX_SATURATION_DETECTOR_CONF_SB AWR_MONITOR_SIG_IMG_MONITOR_CONF_SB AWR_MONITOR_RX_MIXER_IN_POWER_CONF_SB AWR_ANALOG_FAULT_INJECTION_CONF_SB
CRC	Variable	Based on CRCLEN field in FLAGS

4.13 AWR_RF_STATUS_GET_MSG

Field Name	Number of bytes	Description												
SYNC	4	Value = 0x43211234												
OPCODE	2	<table border="0"> <tr> <td>Bits</td> <td>Variable name</td> <td>Value</td> </tr> <tr> <td>b3:0</td> <td>DIRECTION</td> <td>See Table 2.2</td> </tr> <tr> <td>b5:4</td> <td>MSGTYPE</td> <td>00</td> </tr> <tr> <td>b15:6</td> <td>MSGID</td> <td>0x11</td> </tr> </table>	Bits	Variable name	Value	b3:0	DIRECTION	See Table 2.2	b5:4	MSGTYPE	00	b15:6	MSGID	0x11
Bits	Variable name	Value												
b3:0	DIRECTION	See Table 2.2												
b5:4	MSGTYPE	00												
b15:6	MSGID	0x11												
MSGLEN	2	Length of the message in bytes (do not include sync length)												
FLAGS	2	See Section 2.3.2												
REMCHUNKS	2	Value = 0												
NSBC	2	Number of sub blocks contained in the message												
CHKSUM	2	See Section 2.3.2												
MSGDATA	Variable	Supported sub blocks AWR_RF_VERSION_GET_SB												

		AWR_RF_CPUFAULT_STATUS_GET_SB AWR_RF_ESMFAULT_STATUS_GET_SB AWR_RF_DIEID_GET_SB AWR_RF_BOOTUPBIST_STATUS_GET_SB
CRC	Variable	Based on CRCLLEN field in FLAGS

4.14 AWR_RF_MONITORING_REPORT_GET_MSG

Field Name	Number of bytes	Description												
SYNC	4	Value = 0x43211234												
OPCODE	2	<table border="0"> <tr> <td>Bits</td> <td>Variable name</td> <td>Value</td> </tr> <tr> <td>b3:0</td> <td>DIRECTION</td> <td>See Table 2.2</td> </tr> <tr> <td>b5:4</td> <td>MSGTYPE</td> <td>00</td> </tr> <tr> <td>b15:6</td> <td>MSGID</td> <td>0x13</td> </tr> </table>	Bits	Variable name	Value	b3:0	DIRECTION	See Table 2.2	b5:4	MSGTYPE	00	b15:6	MSGID	0x13
Bits	Variable name	Value												
b3:0	DIRECTION	See Table 2.2												
b5:4	MSGTYPE	00												
b15:6	MSGID	0x13												
MSGLEN	2	Length of the message in bytes (do not include sync length)												
FLAGS	2	See Section 2.3.2												
REMCHUNKS	2	Value = 0												
NSBC	2	Number of sub blocks contained in the message												
CHKSUM	2	See Section 2.3.2												
MSGDATA	Variable	Supported sub blocks AWR_RF_DFE_STATISTICS_REPORT_GET_SB												
CRC	Variable	Based on CRCLLEN field in FLAGS												

4.15 AWR_RF_MISC_CONF_SET_MSG

Field Name	Number of bytes	Description												
SYNC	4	Value = 0x43211234												
OPCODE	2	<table border="0"> <tr> <td>Bits</td> <td>Variable name</td> <td>Value</td> </tr> <tr> <td>b3:0</td> <td>DIRECTION</td> <td>See Table 2.2</td> </tr> <tr> <td>b5:4</td> <td>MSGTYPE</td> <td>00</td> </tr> <tr> <td>b15:6</td> <td>MSGID</td> <td>0x16</td> </tr> </table>	Bits	Variable name	Value	b3:0	DIRECTION	See Table 2.2	b5:4	MSGTYPE	00	b15:6	MSGID	0x16
Bits	Variable name	Value												
b3:0	DIRECTION	See Table 2.2												
b5:4	MSGTYPE	00												
b15:6	MSGID	0x16												

MSGLEN	2	Length of the message in bytes (do not include sync length)
FLAGS	2	See Section 2.3.2
REMCHUNKS	2	Value = 0
NSBC	2	Number of sub blocks contained in the message
CHKSUM	2	See Section 2.3.2
MSGDATA	Variable	Supported sub blocks AWR_RF_TEST_SOURCE_CONFIG_SET_SB AWR_RF_TEST_SOURCE_ENABLE_SET_SB AWR_RF_LDO_BYPASS_SB AWR_RF_PALOOPBACK_CFG_SB AWR_RF_PSLOOPBACK_CFG_SB AWR_RF_IFLOOPBACK_CFG_SB AWR_RF_GPADC_CFG_SET_SB
CRC	Variable	Based on CRCLLEN field in FLAGS

4.16 AWR_RF_MISC_CONF_GET_MSG

Field Name	Number of bytes	Description												
SYNC	4	Value = 0x43211234												
OPCODE	2	<table border="0"> <tr> <td>Bits</td> <td>Variable name</td> <td>Value</td> </tr> <tr> <td>b3:0</td> <td>DIRECTION</td> <td>See Table 2.2</td> </tr> <tr> <td>b5:4</td> <td>MSGTYPE</td> <td>00</td> </tr> <tr> <td>b15:6</td> <td>MSGID</td> <td>0x17</td> </tr> </table>	Bits	Variable name	Value	b3:0	DIRECTION	See Table 2.2	b5:4	MSGTYPE	00	b15:6	MSGID	0x17
Bits	Variable name	Value												
b3:0	DIRECTION	See Table 2.2												
b5:4	MSGTYPE	00												
b15:6	MSGID	0x17												
MSGLEN	2	Length of the message in bytes (do not include sync length)												
FLAGS	2	See Section 2.3.2												
REMCHUNKS	2	Value = 0												
NSBC	2	Number of sub blocks contained in the message												
CHKSUM	2	See Section 2.3.2												
MSGDATA	Variable	Supported sub blocks AWR_RF_TEMPERATURE_GET_SB												
CRC	Variable	Based on CRCLLEN field in FLAGS												

4.17 AWR_RF_ASYNC_EVENT_MSG1

The AWR_RF_ASYNC_EVENT_MSG1 is sent by the radar transceiver to the host. This message indicates that specific events have occurred within the device.

Field Name	Number of bytes	Description												
SYNC	4	Value = 0xABCDDBCA												
OPCODE	2	<table border="1"> <thead> <tr> <th>Bits</th> <th>Variable name</th> <th>Value</th> </tr> </thead> <tbody> <tr> <td>b3:0</td> <td>DIRECTION</td> <td>See Table 2.2</td> </tr> <tr> <td>b5:4</td> <td>MSGTYPE</td> <td>11</td> </tr> <tr> <td>b15:6</td> <td>MSGID</td> <td>0x80</td> </tr> </tbody> </table>	Bits	Variable name	Value	b3:0	DIRECTION	See Table 2.2	b5:4	MSGTYPE	11	b15:6	MSGID	0x80
Bits	Variable name	Value												
b3:0	DIRECTION	See Table 2.2												
b5:4	MSGTYPE	11												
b15:6	MSGID	0x80												
MSGLEN	2	Length of the message in bytes (do not include sync length)												
FLAGS	2	See Section 2.3.2												
REMCHUNKS	2	Value = 0												
NSBC	2	Number of sub blocks contained in the message												
CHKSUM	2	See Section 2.3.2												
MSGDATA	Variable	Supported sub blocks AWR_AE_RF_CPUFAULT_SB AWR_AE_RF_ESMFAULT_SB AWR_AE_RF_INITCALIBSTATUS_SB AWR_AE_RF_FRAME_TRIGGER_RDY_SB AWR_AE_RF_GPADC_RESULT_DATA_SB AWR_FRAME_END_AE_SB AWR_ANALOGFAULT_AE_SB AWR_CAL_MON_TIMING_FAIL_REPORT_AE_SB AWR_RUN_TIME_CALIBRATION_SUMMARY_REPORT_AE_SB AWR_MONITOR_RF_DIG_LATENTFAULT_REPORT_AE_SB AWR_MONITOR_REPORT_HEADER_AE_SB AWR_MONITOR_RF_DIG_PERIODIC_REPORT_AE_SB AWR_MONITOR_TEMPERATURE_REPORT_AE_SB AWR_MONITOR_RX_GAIN_PHASE_REPORT_AE_SB AWR_MONITOR_RX_NOISE_FIGURE_REPORT_AE_SB AWR_MONITOR_RX_IFSTAGE_REPORT_AE_SB AWR_MONITOR_TX0_POWER_REPORT_AE_SB AWR_MONITOR_TX1_POWER_REPORT_AE_SB AWR_MONITOR_TX2_POWER_REPORT_AE_SB AWR_MONITOR_TX0_BALLBREAK_REPORT_AE_SB												

		AWR_MONITOR_TX1_BALLBREAK_REPORT_AE_SB
CRC	Variable	Based on CRCLLEN field in FLAGS

4.18 AWR_RF_ASYNC_EVENT_MSG2

The AWR_RF_ASYNC_EVENT_MSG2 is sent by the radar transceiver to the host. This message indicates that specific events have occurred within the device.

Field Name	Number of bytes	Description												
SYNC	4	Value = 0xABCDDBCA												
OPCODE	2	<table border="0"> <tr> <td>Bits</td> <td>Variable name</td> <td>Value</td> </tr> <tr> <td>b3:0</td> <td>DIRECTION</td> <td>See Table 2.2</td> </tr> <tr> <td>b5:4</td> <td>MSGTYPE</td> <td>11</td> </tr> <tr> <td>b15:6</td> <td>MSGID</td> <td>0x81</td> </tr> </table>	Bits	Variable name	Value	b3:0	DIRECTION	See Table 2.2	b5:4	MSGTYPE	11	b15:6	MSGID	0x81
Bits	Variable name	Value												
b3:0	DIRECTION	See Table 2.2												
b5:4	MSGTYPE	11												
b15:6	MSGID	0x81												
MSGLLEN	2	Length of the message in bytes (do not include sync length)												
FLAGS	2	See Section 2.3.2												
REMCHUNKS	2	Value = 0												
NSBC	2	Number of sub blocks contained in the message												
CHKSUM	2	See Section 2.3.2												
MSGDATA	Variable	Supported sub blocks AWR_MONITOR_TX2_BALLBREAK_REPORT_AE_SB AWR_MONITOR_TX_GAIN_PHASE_MISMATCH_REPORT_AE_SB AWR_MONITOR_TX0_BPM_REPORT_AE_SB AWR_MONITOR_TX1_BPM_REPORT_AE_SB AWR_MONITOR_TX2_BPM_REPORT_AE_SB AWR_MONITOR_SYNTHESIZER_FREQUENCY_REPORT_AE_SB AWR_MONITOR_EXTERNAL_ANALOG_SIGNALSREPORT_AE_SB AWR_MONITOR_TX0_INTERNAL_ANALOG_SIGNALS_REPORT_AE_SB AWR_MONITOR_TX1_INTERNAL_ANALOG_SIGNALS_REPORT_AE_SB AWR_MONITOR_TX2_INTERNAL_ANALOG_SIGNALS_REPORT_AE_SB												

		AWR_MONITOR_RX_INTERNAL_ANALOG_SIGNALS_REPORT_AE_SB AWR_MONITOR_PMCLKLO_INTERNAL_ANALOG_SIGNALS_REPORT_AE_SB AWR_MONITOR_GPADC_INTERNAL_ANALOG_SIGNALS_REPORT_AE_SB AWR_MONITOR_PLL_CONTROL_VOLTAGE_REPORT_AE_SB AWR_MONITOR_DUAL_CLOCK_COMP_REPORT_AE_SB AWR_MONITOR_RX_MIXER_IN_POWER_REPORT_AE_SB AWR_MONITOR_SYNTHESIZER_FREQUENCY_NONLIVE_REPORT_AE_SB
CRC	Variable	Based on CRCLEN field in FLAGS

4.19 AWR_DEV_RFPOWERUP_MSG

The AWR_DEV_RFPOWERUP_MSG is sent by the host to the MSS. This message indicates that BSS can now be powered up.

Field Name	Number of bytes	Description
SYNC	4	Value = 0xABCDDBCA
OPCODE	2	Bits Variable name Value b3:0 DIRECTION See Table 2.2 b5:4 MSGTYPE 00 b15:6 MSGID 0x200
MSGLEN	2	Length of the message in bytes (do not include sync length)
FLAGS	2	See Section 2.3.2
REMCHUNKS	2	Value = 0
NSBC	2	Number of sub blocks contained in the message
CHKSUM	2	See Section 2.3.2
MSGDATA	Variable	Supported sub blocks AWR_DEV_RFPOWERUP_SB
CRC	Variable	Based on CRCLEN field in FLAGS

4.20 AWR_DEV_CONF_SET_MSG

The AWR_DEV_CONF_SET_MSG is sent by the host to the radar transceiver. This message indicates that specific events have occurred within the device.

Field Name	Number of bytes	Description
SYNC	4	Value = 0x43211234
OPCODE	2	Bits Variable name Value b3:0 DIRECTION See Table 2.2 b5:4 MSGTYPE 00 b15:6 MSGID 0x202
MSGLEN	2	Length of the message in bytes (do not include sync length)
FLAGS	2	See Section 2.3.2
REMCHUNKS	2	Value = 0
NSBC	2	Number of sub blocks contained in the message
CHKSUM	2	See Section 2.3.2
MSGDATA	Variable	Supported sub blocks AWR_DEV_MCUCLOCK_CONF_SET_SB AWR_DEV_RX_DATA_FORMAT_CONF_SET_SB AWR_DEV_RX_DATA_PATH_CONF_SET_SB AWR_DEV_RX_DATA_PATH_LANEEN_SET_SB AWR_DEV_RX_DATA_PATH_CLK_SET_SB AWR_DEV_LVDS_CFG_SET_SB AWR_DEV_RX_CONTSTREAMING_MODE_CONF_SET_SB AWR_DEV_CSI2_CFG_SET_SB AWR_DEV_PMICCLOCK_CONF_SET_SB AWR_MSS_LATENTFAULT_TEST_CONF_SB AWR_MSS_PERIODICTESTS_CONF_SB AWR_DEV_TESTPATTERN_GEN_SET_SB AWR_DEV_CONFIGURATION_SET_SB
CRC	Variable	Based on CRCLEN field in FLAGS

4.21 AWR_DEV_CONF_GET_MSG

The AWR_DEV_CONF_GET_MSG is sent by the host to the radar transceiver to read back the configuration values.

Field Name	Number of bytes	Description												
SYNC	4	Value = 0x43211234												
OPCODE	2	<table border="1"> <thead> <tr> <th>Bits</th> <th>Variable name</th> <th>Value</th> </tr> </thead> <tbody> <tr> <td>b3:0</td> <td>DIRECTION</td> <td>See Table 2.2</td> </tr> <tr> <td>b5:4</td> <td>MSGTYPE</td> <td>00</td> </tr> <tr> <td>b15:6</td> <td>MSGID</td> <td>0x203</td> </tr> </tbody> </table>	Bits	Variable name	Value	b3:0	DIRECTION	See Table 2.2	b5:4	MSGTYPE	00	b15:6	MSGID	0x203
Bits	Variable name	Value												
b3:0	DIRECTION	See Table 2.2												
b5:4	MSGTYPE	00												
b15:6	MSGID	0x203												
MSGLEN	2	Length of the message in bytes (do not include sync length)												
FLAGS	2	See Section 2.3.2												
REMCHUNKS	2	Value = 0												
NSBC	2	Number of sub blocks contained in the message												
CHKSUM	2	See Section 2.3.2												
MSGDATA	Variable	Supported sub blocks AWR_DEV_MCUCLOCK_GET_SB AWR_DEV_RX_DATA_FORMAT_CONF_GET_SB AWR_DEV_RX_DATA_PATH_CONF_GET_SB AWR_DEV_RX_DATA_PATH_LANEEN_GET_SB AWR_DEV_RX_DATA_PATH_CLK_GET_SB AWR_DEV_LVDS_CFG_GET_SB AWR_DEV_RX_CONTSTREAMING_MODE_CONF_GET_SB AWR_DEV_CSI2_CFG_GET_SB AWR_DEV_PMICLOCK_CONF_GET_SB AWR_MSS_LATENTFAULT_TEST_CONF_GET_SB AWR_MSS_PERIODICCONF_GET_SB AWR_DEV_TESTPATTERN_GEN_GET_SB												
CRC	Variable	Based on CRCLEN field in FLAGS												

4.22 AWR_DEV_FILE_DOWNLOAD_MSG

The AWR_DEV_FILE_DOWNLOAD_MSG is sent by the host to MSS. This message sends a file to be written into the device.

Field Name	Number of bytes	Description
------------	-----------------	-------------

SYNC	4	Value = 0x43211234												
OPCODE	2	<table border="1"> <thead> <tr> <th>Bits</th> <th>Variable name</th> <th>Value</th> </tr> </thead> <tbody> <tr> <td>b3:0</td> <td>DIRECTION</td> <td>See Table 2.2</td> </tr> <tr> <td>b5:4</td> <td>MSGTYPE</td> <td>00</td> </tr> <tr> <td>b15:6</td> <td>MSGID</td> <td>0x204</td> </tr> </tbody> </table>	Bits	Variable name	Value	b3:0	DIRECTION	See Table 2.2	b5:4	MSGTYPE	00	b15:6	MSGID	0x204
Bits	Variable name	Value												
b3:0	DIRECTION	See Table 2.2												
b5:4	MSGTYPE	00												
b15:6	MSGID	0x204												
MSGLEN	2	Length of the message in bytes (do not include sync length)												
FLAGS	2	See Section 2.3.2												
REMCHUNKS	2	Value = 0												
NSBC	2	Number of sub blocks contained in the message												
CHKSUM	2	See Section 2.3.2												
MSGDATA	Variable	Supported sub blocks AWR_DEV_FILE_DOWNLOAD_SB												
CRC	Variable	Based on CRCLLEN field in FLAGS												

4.23 AWR_DEV_FRAME_CONFIG_APPLY_MSG

The AWR_DEV_FRAME_CONFIG_APPLY_MSG is sent by the host to MSS. This message indicates to MSS to apply all the regular framing mode configurations related to ADC buffer and CBUFF.

Field Name	Number of bytes	Description												
SYNC	4	Value = 0x43211234												
OPCODE	2	<table border="1"> <thead> <tr> <th>Bits</th> <th>Variable name</th> <th>Value</th> </tr> </thead> <tbody> <tr> <td>b3:0</td> <td>DIRECTION</td> <td>See Table 2.2</td> </tr> <tr> <td>b5:4</td> <td>MSGTYPE</td> <td>00</td> </tr> <tr> <td>b15:6</td> <td>MSGID</td> <td>0x206</td> </tr> </tbody> </table>	Bits	Variable name	Value	b3:0	DIRECTION	See Table 2.2	b5:4	MSGTYPE	00	b15:6	MSGID	0x206
Bits	Variable name	Value												
b3:0	DIRECTION	See Table 2.2												
b5:4	MSGTYPE	00												
b15:6	MSGID	0x206												
MSGLEN	2	Length of the message in bytes (do not include sync length)												
FLAGS	2	See Section 2.3.2												
REMCHUNKS	2	Value = 0												
NSBC	2	Number of sub blocks contained in the message												
CHKSUM	2	See Section 2.3.2												
MSGDATA	Variable	Supported sub blocks AWR_DEV_FRAME_CONFIG_APPLY_SB AWR_DEV_ADV_FRAME_CONFIG_APPLY_SB												

CRC	Variable	Based on CRCLLEN field in FLAGS
-----	----------	---------------------------------

4.24 AWR_DEV_STATUS_GET_MSG

The AWR_DEV_STATUS_GET_MSG is sent by the host to MSS to get some status information from the device.

Field Name	Number of bytes	Description												
SYNC	4	Value = 0x43211234												
OPCODE	2	<table border="0"> <tr> <td>Bits</td> <td>Variable name</td> <td>Value</td> </tr> <tr> <td>b3:0</td> <td>DIRECTION</td> <td>See Table 2.2</td> </tr> <tr> <td>b5:4</td> <td>MSGTYPE</td> <td>00</td> </tr> <tr> <td>b15:6</td> <td>MSGID</td> <td>0x207</td> </tr> </table>	Bits	Variable name	Value	b3:0	DIRECTION	See Table 2.2	b5:4	MSGTYPE	00	b15:6	MSGID	0x207
Bits	Variable name	Value												
b3:0	DIRECTION	See Table 2.2												
b5:4	MSGTYPE	00												
b15:6	MSGID	0x207												
MSGLEN	2	Length of the message in bytes (do not include sync length)												
FLAGS	2	See Section 2.3.2												
REMCHUNKS	2	Value = 0												
NSBC	2	Number of sub blocks contained in the message												
CHKSUM	2	See Section 2.3.2												
MSGDATA	Variable	Supported sub blocks AWR_MSSVERSION_GET_SB AWR_MSSCPUFAULT_STATUS_GET_SB AWR_MSSSEMFault_STATUS_GET_SB												
CRC	Variable	Based on CRCLLEN field in FLAGS												

4.25 AWR_DEV_ASYNC_EVENT_MSG

The AWR_DEV_ASYNC_EVENT_MSG is sent by the radar transceiver to the host. This message indicates that specific events have occurred within the device.

Field Name	Number of bytes	Description												
SYNC	4	Value = 0x43211234												
OPCODE	2	<table border="0"> <tr> <td>Bits</td> <td>Variable name</td> <td>Value</td> </tr> <tr> <td>b3:0</td> <td>DIRECTION</td> <td>See Table 2.2</td> </tr> <tr> <td>b5:4</td> <td>MSGTYPE</td> <td>11</td> </tr> <tr> <td>b15:6</td> <td>MSGID</td> <td>0x280</td> </tr> </table>	Bits	Variable name	Value	b3:0	DIRECTION	See Table 2.2	b5:4	MSGTYPE	11	b15:6	MSGID	0x280
Bits	Variable name	Value												
b3:0	DIRECTION	See Table 2.2												
b5:4	MSGTYPE	11												
b15:6	MSGID	0x280												

MSGLEN	2	Length of the message in bytes (do not include sync length)
FLAGS	2	See Section 2.3.2
REMCHUNKS	2	Value = 0
NSBC	2	Number of sub blocks contained in the message
CHKSUM	2	See Section 2.3.2
MSGDATA	Variable	Supported sub blocks AWR_AE_DEV_MSSPOWERUPDONE_SB AWR_AE_DEV_RFPOWERUPDONE_SB AWR_AE_MSS_CPUFAULT_SB AWR_AE_MSS_ESMFAULT_SB AWR_AE_MSS_BOOTERRORSTATUS_SB AWR_AE_MSS_LATENTFAULT_TESTREPORT_SB AWR_AE_MSS_PERIODICTEST_STATUS_SB AWR_AE_MSS_RFERROR_STATUS_SB AWR_AE_MSS_VMON_ERRORSTATUS_SB AWR_AE_MSS_ADC_DATA_SB
CRC	Variable	Based on CRCLLEN field in FLAGS

5 Radar Functional APIs

This section describes all the radar interface sub blocks that are used in messages for communicating with the radar transceiver. Some of the sub blocks are status responses from the radar device. All the API sub-blocks defined in this document are applicable to all mmWave Radar Sensors unless it is specified in the sub-block.

5.1 Sub block related to AWR_ERROR_MSG

5.1.1 Sub block 0x0000 – AWR_RESP_ERROR_SB

This sub block contains the error response for an API command. Table 5.1 describes the contents of this sub block.

Table 5.1: AWR_RESP_ERROR_SB contents

Field Name	Number of bytes	Description
SBLKID	2	Value = 0x0000
SBLKLEN	2	Value = 8
API_RESP	2	0x0001 ERROR_CMD: Incorrect MSGID 0x0002 ERROR_CMD: No Sub block found in the MSG 0x0003 ERROR_CMD: Incorrect Sub block ID 0x0004 ERROR_CMD: Incorrect Sub block Length 0x0005 ERROR_CMD: Incorrect Sub block data 0x0006 ERROR_PROC: Error in processing the command 0x0007 ERROR_FILECRCMISMATCH: File CRC mismatched 0x0008 ERROR_FILETYPEMISMATCH: File type mismatched w.r.t. magic number 0x0009 See Section 7 for details on error codes from each API - 0xFFFF

API_RESP_ERROR_SBC_ID	2	0x0000 Sub-Block ID in which Error Occurred for sub-block related errors – 0xFFFF
-----------------------	---	-----------------------------------------------------------------------------------------

5.2 Sub blocks related to AWR_RF_STATIC_CONF_SET_MSG

5.2.1 Sub block 0x0080 – AWR_CHAN_CONF_SET_SB

This sub block contains static device configurations (applicable for the given power cycle) - how many RX and TX channels are needed for operation. It also defines static configurations related to whether the sensor uses a single mmWave or multiple chips to realize a larger antenna array (multiple is applicable only in AWR1243). Table 5.2 describes the contents of this sub block.

Table 5.2: AWR_CHAN_CONF_SET_SB contents

Field Name	Number of bytes	Description
SBLKID	2	Value = 0x0080
SBLKLEN	2	Value = 12
RX_CHAN_EN	2	This field specifies which RX channels are to be enabled Bit Description b0 RX_CHAN0_EN 0 Disable RX Channel 0 1 Enable RX Channel 0 b1 RX_CHAN1_EN 0 Disable RX Channel 1 1 Enable RX Channel 1 b2 RX_CHAN2_EN 0 Disable RX Channel 2 1 Enable RX Channel 2 b3 RX_CHAN3_EN 0 Disable RX Channel 3 1 Enable RX Channel 3 b15:4 RESERVED 0b000000000000

Continued on next page

Table 5.2 – continued from previous page

TX_CHAN_EN	2	<p>This field specifies which TX channels are to be enabled</p> <table border="0"> <thead> <tr> <th>Bit</th> <th>Description</th> </tr> </thead> <tbody> <tr> <td>b0</td> <td>TX_CHAN0_EN</td> </tr> <tr> <td>0</td> <td>Disable TX Channel 0</td> </tr> <tr> <td>1</td> <td>Enable TX Channel 0</td> </tr> <tr> <td>b1</td> <td>TX_CHAN1_EN</td> </tr> <tr> <td>0</td> <td>Disable TX Channel 1</td> </tr> <tr> <td>1</td> <td>Enable TX Channel 1</td> </tr> <tr> <td>b2</td> <td>TX_CHAN2_EN (3rd Tx is supported only on some of the devices, Please refer device data sheet)</td> </tr> <tr> <td>0</td> <td>Disable TX Channel 2</td> </tr> <tr> <td>1</td> <td>Enable TX Channel 2</td> </tr> <tr> <td>b15:3</td> <td>RESERVED</td> </tr> <tr> <td></td> <td>0b0000000000000</td> </tr> </tbody> </table>	Bit	Description	b0	TX_CHAN0_EN	0	Disable TX Channel 0	1	Enable TX Channel 0	b1	TX_CHAN1_EN	0	Disable TX Channel 1	1	Enable TX Channel 1	b2	TX_CHAN2_EN (3rd Tx is supported only on some of the devices, Please refer device data sheet)	0	Disable TX Channel 2	1	Enable TX Channel 2	b15:3	RESERVED		0b0000000000000
Bit	Description																									
b0	TX_CHAN0_EN																									
0	Disable TX Channel 0																									
1	Enable TX Channel 0																									
b1	TX_CHAN1_EN																									
0	Disable TX Channel 1																									
1	Enable TX Channel 1																									
b2	TX_CHAN2_EN (3rd Tx is supported only on some of the devices, Please refer device data sheet)																									
0	Disable TX Channel 2																									
1	Enable TX Channel 2																									
b15:3	RESERVED																									
	0b0000000000000																									
CASCADING_CFG	2	<p>This field specifies the cascading configuration.</p> <table border="0"> <thead> <tr> <th>Value</th> <th>Description</th> </tr> </thead> <tbody> <tr> <td>0x0000</td> <td>SINGLECHIP: Single mmWave sensor application</td> </tr> <tr> <td>0x0001</td> <td>MULTICHIP_MASTER: Multiple cascade sensor application. This device is a master chip and generates LO and conveys to other slave sensors. This is applicable only for device which supports cascading.</td> </tr> <tr> <td>0x0002</td> <td>MULTICHIP_SLAVE: Multiple cascade sensor application. This device is a slave chip and uses LO conveyed to it by the master sensor. This is applicable only for device which supports cascading.</td> </tr> </tbody> </table> <p>MULTICHIP_MASTER and MULTICHIP_SLAVE are in general referred to as MULTICHIP applications, where larger antenna array sizes are possible in comparison with SINGLECHIP cases.</p> <p>Please refer device data sheet for cascading capability and 20G SYNC pins.</p>	Value	Description	0x0000	SINGLECHIP: Single mmWave sensor application	0x0001	MULTICHIP_MASTER: Multiple cascade sensor application. This device is a master chip and generates LO and conveys to other slave sensors. This is applicable only for device which supports cascading.	0x0002	MULTICHIP_SLAVE: Multiple cascade sensor application. This device is a slave chip and uses LO conveyed to it by the master sensor. This is applicable only for device which supports cascading.																
Value	Description																									
0x0000	SINGLECHIP: Single mmWave sensor application																									
0x0001	MULTICHIP_MASTER: Multiple cascade sensor application. This device is a master chip and generates LO and conveys to other slave sensors. This is applicable only for device which supports cascading.																									
0x0002	MULTICHIP_SLAVE: Multiple cascade sensor application. This device is a slave chip and uses LO conveyed to it by the master sensor. This is applicable only for device which supports cascading.																									

Continued on next page

Table 5.2 – continued from previous page

		Bit	Description
CASCADING_ PINOUTCFG	2	b0	FM_CW_CLKOUT_MASTER_DIS Applicable only in MUTICHIP_MASTER device. Default value is 0 0 Enable FM_CW_CLKOUT on master 1 Disable FM_CW_CLKOUT on master
		b1	FM_CW_SYNCOUT_MASTER_DIS Applicable only in MULTICHIP_MASTER device. Default value is 0 0 Enable FM_CW_SYNCOUT on master 1 Disable FM_CW_SYNCOUT on master
		b2	FM_CW_CLKOUT_SLAVE_EN Applicable only in MULTICHIP_SLAVE device. Default value is 0 0 Disable FM_CW_CLKOUT on slave 1 Enable FM_CW_CLKOUT on slave
		b3	FM_CW_SYNCOUT_SLAVE_EN Applicable only in MULTICHIP_SLAVE device. Default value is 0 0 Disable FM_CW_SYNCOUT on slave 1 Enable FM_CW_SYNCOUT on slave
		b4	INTLO_MASTER_EN Applicable only in MULTICHIP_MASTER device. Default value is 0 0 Use externally looped back LO 1 Use internal LO in master Note that the externally looped-back LO mode is useful when length-matching the 20 GHz path between master and slave device.
		b5	OSCCLKOUT_MASTER_DIS Applicable only in MULTICHIP_MASTER device. Default value is 0 0 Enable OSCCLKOUT in master 1 Disable OSCCLKOUT in master
		b15:6	RESERVED

NOTE: The cascade features are not supported in DFP 1.x (1st generation devices). Please refer latest release note for more info.

5.2.2 Sub block 0x0082 – AWR_ADCOUT_CONF_SET_SB

This sub block contains static device configurations (applicable for the given power cycle) - regarding the data format of the ADC output (including the digital filtering).

Table 5.3 describes the contents of this sub block.

Table 5.3: AWR_ADCOUT_CONF_SB contents

Field Name	Number of bytes	Description
SBLKID	2	Value = 0x0082
SBLKLEN	2	Value = 12
NUM_ADC_BITS	1	Bit Description b1:0 Value Definition 00 12 bits 01 14 bits 10 16 bits Other RESERVED b7:2 RESERVED 0b000000
FULL_SCALE_REDUCTION_FACTOR	1	Number of bits to reduce ADC full scale by Valid range: 0 to (16 – Number of ADC bits) For e.g. for 12 bit ADC output, this field can take values 0, 1, 2 or 3 For 14 bit ADC output, this field can take values 0, 1 or 2 For 16 bit ADC output, this field can take only value 0 Example: If the user desires 12 bit ADC output, then the digital front end (DFE) chain drops 4 LSBs before placing the data in ADC buffer (DFE output is 16 bits wide). If the user sets FULL_SCALE_REDUCTION_FACTOR as 1, then the DFE will drop only 3 LSBs but still restricting the data in ADC buffer to be within $\pm 2^{12}$. This allows wider ADC swings in smaller signal conditions.

Continued on next page

Table 5.3 – continued from previous page

ADC_OUT_FMT	2	Bits	Description
		b1:0	Value Definition
		00	Real
		01	Complex 1x (image band filtered out)
		10	Complex 2x (image band visible)
		11	Pseudo Real
		b15:2	RESERVED
			0b00000000000000
RESERVED	2	0x0000	
RESERVED	2	0x0000	

5.2.3 Sub block 0x0083 – AWR_LOWPOWERMODE_CONF_SET_SB

This sub block contains static device configurations (applicable for this power cycle) - Sigma Delta ADC root sampling clock rate (reducing rate to half to save power in small IF bandwidth applications).

Table 5.4 describes the contents of this sub block.

Table 5.4: AWR_LOWPOWERMODE_CONF_SET_SB contents

Field Name	Number of bytes	Description
SBLKID	2	Value = 0x0083
SBLKLEN	2	Value = 8
RESERVED	2	0x0000
LP_ADC_MODE	2	Value Definition
		0x00 Regular ADC mode
		0x01 Low power ADC mode

NOTE:

Low power ADC mode is mandatory on a 5 MHz part variant (for e.g. xWR1642), Normally if IF BW \leq 7.5MHz then low power mode setting is recommended.

5.2.4 Sub block 0x0084 – AWR_DYNAMICPOWERSAVE_CONF_SET_SB

This sub block defines static device configuration - whether to enable dynamic power saving during inter-chirp IDLE times by turning off various circuits e.g. TX, RX, LO Distribution blocks. If

Idle time + Tx start time < 10us or Idle time < 3.5us then inter-chirp dynamic power save option will be disabled, in that case, 15us of inter-burst idle time will be utilized to configure sequencer LO, TX and RX signal timings by firmware.

Table 5.4 describes the contents of this sub block.

Table 5.5: AWR_DYNAMICPOWERSAVE_CONF_SET_SB contents

Field Name	Number of bytes	Description
SBLKID	2	Value = 0x0084
SBLKLEN	2	Value = 8
BLOCK_CFG	2	Bits Definition b0 Enable power save by switching off TX during inter-chirp IDLE period 0 Disable 1 Enable Default value: 1 (power saving is enabled) b1 Enable power save by switching off RX during inter-chirp IDLE period 0 Disable 1 Enable Default value: 1 (power saving is enabled) b2 Enable power save by switching off LO Distribution blocks during inter-chirp IDLE period 0 Disable 1 Enable Default value: 1 (power saving is enabled) b15:3 RESERVED 0b00000000000000
RESERVED	2	0x0000

NOTE: All the 3 configuration bits (TX, RX and LO) should have same value, i.e. user should program value 0x7 to enable power save or 0x0 to disable the power save in BLOCK_CFG.

5.2.5 Sub block 0x0085 – AWR_HIGHSPEEDINTFCLK_CONF_SET_SB

This sub block contains static device configurations (applicable for the given power cycle) - regarding high speed interface clock rates which are related to sending the ADC data from AWR device to the host in either LVDS or CSI2 format.

Table 5.6 describes the contents of this sub block.

Table 5.6: AWR_HIGHSPEEDINTFCLK_CONF_SET_SB contents

Field Name	Number of bytes	Description																														
SBLKID	2	Value = 0x0085																														
SBLKLEN	2	Value = 8																														
HSICKRATE_CODE	2	<p>This field indicates the high speed interface input clock rate, needed by the LVDS or CSI2 module. It should be N times the final serial data rate, where $N = 2$ in DDR mode and $N = 1$ in SDR mode.</p> <p>Bit 15:5 = Reserved (all 0). Bit 3:0 are to be set based on desired rate as follows:</p> <table border="1" style="margin-left: auto; margin-right: auto;"> <thead> <tr> <th></th> <th>b1:0</th> <th>b1:0</th> <th>b1:0</th> <th>b1:0</th> </tr> </thead> <tbody> <tr> <td></td> <td>00</td> <td>01</td> <td>10</td> <td>11</td> </tr> <tr> <td>b3:2 00</td> <td>Reserved</td> <td>800 MHz</td> <td>400 MHz</td> <td>200 MHz</td> </tr> <tr> <td>b3:2 01</td> <td>Reserved</td> <td>900 MHz</td> <td>450 MHz</td> <td>225 MHz</td> </tr> <tr> <td>b3:2 10</td> <td>Reserved</td> <td>1200 MHz</td> <td>600 MHz</td> <td>300 MHz</td> </tr> <tr> <td>b3:2 11</td> <td>Reserved</td> <td>1800 MHz</td> <td>Reserved</td> <td>Reserved</td> </tr> </tbody> </table> <p>For example, for 900 Mbps output rate with DDR, choose Bit3:0=0b1101, and for 450 Mbps output rate with SDR, choose Bit3:0=0b0110.</p>		b1:0	b1:0	b1:0	b1:0		00	01	10	11	b3:2 00	Reserved	800 MHz	400 MHz	200 MHz	b3:2 01	Reserved	900 MHz	450 MHz	225 MHz	b3:2 10	Reserved	1200 MHz	600 MHz	300 MHz	b3:2 11	Reserved	1800 MHz	Reserved	Reserved
	b1:0	b1:0	b1:0	b1:0																												
	00	01	10	11																												
b3:2 00	Reserved	800 MHz	400 MHz	200 MHz																												
b3:2 01	Reserved	900 MHz	450 MHz	225 MHz																												
b3:2 10	Reserved	1200 MHz	600 MHz	300 MHz																												
b3:2 11	Reserved	1800 MHz	Reserved	Reserved																												
RESERVED	2	0x0000																														

5.2.6 Sub block 0x0086 – AWR_RF_DEVICE_CFG_SB

This sub block configures the direction of async event from BSS. Typically async events are sent to MSS. With this API, the user can configure the destination of async event.

Table 5.7 describes the contents of this sub block.

Table 5.7: AWR_RF_DEVICE_CFG_SB contents

Field Name	Number of bytes	Description
SBLKID	2	Value = 0x0086
SBLKLEN	2	Value = 16
RF_AE_DIRECTION	4	<p>Bits Definition</p> <p>b1:0 ASYNC_EVENT_DIR</p> <p> 00 BSS to MSS</p> <p> 01 BSS to HOST</p> <p> 10 BSS to DSS</p> <p> 11 RESERVED</p> <p>The ASYNC_EVENT_DIR controls the direction for following ASYNC_EVENTS</p> <p> 1. CPU_FAULT</p> <p> 2. ESM_FAULT</p> <p> 3. ANALOG_FAULT</p> <p>All other ASYNC_EVENTS are sent to the subsystem which issues the API</p> <p>Default value: 0b00</p> <p>b3:2 MONITORING_ASYNC_EVENT_DIR</p> <p> 00 BSS to MSS</p> <p> 01 BSS to HOST</p> <p> 10 BSS to DSS</p> <p> 11 RESERVED</p> <p>Default value: 0b00</p> <p>b31:4 RESERVED</p> <p> 0x0000000</p>

Continued on next page

Table 5.7 – continued from previous page

AE_CONTROL	1	Bits Definition b0 FRAME_START_ASYNC_EVENT_DIS 0 Frame Start async event enable 1 Frame Start async event disable Default value: 0 b1 FRAME_STOP_ASYNC_EVENT_DIS 0 Frame Stop async event enable 1 Frame Stop async event disable Default value: 0 b7:2 RESERVED 0b000000
RESERVED	2	0x0000
BSS_DIG_CTRL	1	Bits Definition b0 WDT_DISABLE 0 Keep watchdog disabled 1 Enable watchdog b7:1 RESERVED 0b0000000 NOTE: The Windowed WDT can be enabled only in Sw triggered framing Mode or in cascade mode where frames of all the devices synchronized with same clock source, if frames are triggered from Hw trigger pulse generated from unsynchronized clock then WDT can not be enabled. Refer section 9.4 for more details on WDT timing and programming window 364
ASYNC_EVENT_CRC_CONFIG	1	Value Description 0 16 bit CRC for BSS async events 1 32 bit CRC for BSS async events 2 64 bit CRC for BSS async events
RESERVED	3	0x000000

5.2.7 Sub block 0x0087 – AWR_RF_RADAR_MISC_CTL_SB

This sub block controls miscellaneous global RF controls for e.g. per-chirp phase shifter global control.

NOTE: Issue this API first in the sequence if AWR_PERCHIRPPHASESHIFT_CONF_SB and AWR_DYN_PERCHIRP_PHASESHIFTER_CONF_SET_SB are issued down in the sequence.

Table 5.8 describes the contents of this sub block.

Table 5.8: AWR_RF_MISC_CTL_SB contents

Field Name	Number of bytes	Description
SBLKID	2	Value = 0x0087
SBLKLEN	2	Value = 12
RF_MISC_CTL	4	Bits Definition b0 PERCHIRP_PHASESHIFTER_EN 0 Per chirp phase shifter is disabled 1 Per chirp phase shifter is enabled This control is applicable only in devices which support phase shifter (refer data sheet). For other devices, this is a RESERVED bit and should be set to 0. Default value: 0 b31:1 RESERVED 0b000_0000_0000_0000_0000_0000_0000_0000
RESERVED	4	0x00000000

5.2.8 Sub block 0x0088 – AWR_CAL_MON_FREQUENCY_LIMITS_SB

This sub block sets the limits for RF frequency transmission. This API is deprecated as a new API AWR_CAL_MON_FREQUENCY_TX_POWER_LIMITS_SB is added to limit frequency for each TX channels in Table 5.11

Table 5.9 describes the contents of this sub block.

Table 5.9: AWR_CAL_MON_FREQUENCY_LIMITS_SB contents

Field Name	Number of bytes	Description
SBLKID	2	Value = 0x0088
SBLKLEN	2	Value = 16

Continued on next page

Table 5.9 – continued from previous page

FREQ_LIMIT_LOW	2	<p>The sensor's lower frequency limit for calibrations and monitoring is encoded in 2 bytes (16 bit unsigned number) 1 LSB = 100 MHz For 77GHz Devices(76GHz to 81Ghz): Valid range: 760 to 810 Default value: 760 (If this API is not issued) For 60GHz Devices(57GHz to 64Ghz): Valid range: 570 to 640 Default value: 570 (If this API is not issued)</p>
FREQ_LIMIT_HIGH	2	<p>The sensor's higher frequency limit for calibrations and monitoring is encoded in 2 bytes (16 bit unsigned number) 1 LSB = 100 MHz For 77GHz Devices (76GHz to 81Ghz): Valid range: 760 to 810 Default value: 810 (If this API is not issued) For 60GHz Devices(57GHz to 64Ghz): Valid range: 570 to 640 Default value: 640 (If this API is not issued) NOTE: FREQ_LIMIT_HIGH should be strictly greater than FREQ_LIMIT_LOW Examples: For an LRR device deployed in the US, one might typically configure FREQ_LIMIT_LOW to 760 and FREQ_LIMIT_HIGH to 770.</p>
RESERVED	8	<p>RESERVED 0x0000_0000_0000_0000</p>

NOTE1:	The minimum RF bandwidth shall be set to 200MHz, this is to perform internal calibration and monitoring.
NOTE2:	The limit set in this API is not applicable for functional chirps and loop-back chirps used in advanced frame config API.
NOTE3:	The TX0 frequency limit is used by default in calibrations and monitors where TX is not relevant or enabled.
NOTE4:	The RF band used in functional chirp profiles shall be within the limit set in this API.
NOTE5:	The mid frequency code of RF band used in functional chirp profiles + 200MHz shall be within the max limit set in this API.

5.2.9 Sub block 0x0089 – AWR_RF_INIT_CALIBRATION_CONF_SB

This sub block configures device to perform boot time calibration.
 Table 5.10 describes the contents of this sub block.

Table 5.10: AWR_RF_INIT_CALIBRATION_CONF_SB contents

Field Name	Number of bytes	Description																														
SBLKID	2	Value = 0x0089																														
SBLKLEN	2	Value = 16																														
RF_INIT_CALIB_ENABLE_MASK	4	<p>Normally, upon receiving RF INIT message, the BSS performs all relevant initial calibrations. This step can be disabled by the host by setting the corresponding calibration bit in this field to 0x0. If disabled, the host needs to send the INJECT CALIB DATA message so that the BSS can operate using the calibration data thus injected.</p> <p>Each of these calibrations can be selectively disabled by issuing this message before RF INIT message.</p> <table border="0"> <tr> <td>Bit</td> <td>Definition</td> </tr> <tr> <td>b0</td> <td>RESERVED</td> </tr> <tr> <td>b1</td> <td>RESERVED</td> </tr> <tr> <td>b2</td> <td>RESERVED</td> </tr> <tr> <td>b3</td> <td>RESERVED</td> </tr> <tr> <td>b4</td> <td>Enable LODIST calibration</td> </tr> <tr> <td>b5</td> <td>Enable RX ADC DC offset calibration</td> </tr> <tr> <td>b6</td> <td>Enable HPF cutoff calibration</td> </tr> <tr> <td>b7</td> <td>Enable LPF cutoff calibration</td> </tr> <tr> <td>b8</td> <td>Enable Peak detector calibration</td> </tr> <tr> <td>b9</td> <td>Enable TX power calibration</td> </tr> <tr> <td>b10</td> <td>Enable RX gain calibration</td> </tr> <tr> <td>b11</td> <td>Enable TX Phase calibration (Device dependent feature, please refer data sheet)</td> </tr> <tr> <td>b12</td> <td>Enable RX IQMM calibration</td> </tr> <tr> <td>b31:13</td> <td>RESERVED</td> </tr> </table> <p>0b000_0000_0000_0000_0000 Default value: 0x1FF0</p> <p>NOTE: If calibrations are disabled then it is mandatory to restore the same.</p>	Bit	Definition	b0	RESERVED	b1	RESERVED	b2	RESERVED	b3	RESERVED	b4	Enable LODIST calibration	b5	Enable RX ADC DC offset calibration	b6	Enable HPF cutoff calibration	b7	Enable LPF cutoff calibration	b8	Enable Peak detector calibration	b9	Enable TX power calibration	b10	Enable RX gain calibration	b11	Enable TX Phase calibration (Device dependent feature, please refer data sheet)	b12	Enable RX IQMM calibration	b31:13	RESERVED
Bit	Definition																															
b0	RESERVED																															
b1	RESERVED																															
b2	RESERVED																															
b3	RESERVED																															
b4	Enable LODIST calibration																															
b5	Enable RX ADC DC offset calibration																															
b6	Enable HPF cutoff calibration																															
b7	Enable LPF cutoff calibration																															
b8	Enable Peak detector calibration																															
b9	Enable TX power calibration																															
b10	Enable RX gain calibration																															
b11	Enable TX Phase calibration (Device dependent feature, please refer data sheet)																															
b12	Enable RX IQMM calibration																															
b31:13	RESERVED																															
RESERVED	4	0x00000000																														
RESERVED	4	0x00000000																														

NOTE1: The APLL, SYNTH1 and SYNTH2 calibrations are always triggered by default on RF init command

5.2.10 Sub block 0x008A – AWR_CAL_MON_FREQUENCY_TX_POWER_LIMITS_SB

This sub block sets the limits for RF frequency transmission for each TX and also TX power limits.

Table 5.11: AWR_CAL_MON_FREQUENCY_TX_POWER_LIMITS_SB contents

Field Name	Number of bytes	Description
SBLKID	2	Value = 0x008A
SBLKLEN	2	Value = 28
FREQ_LIMIT_LOW_TX0	2	The sensor's lower frequency limit for calibrations and monitoring for TX0 is encoded in 2 bytes (16 bit unsigned number) 1 LSB = 10 MHz For 77GHz Devices(76GHz to 81Ghz): Valid range: 7600 to 8100 Default value: 7600 (If this API is not issued) For 60GHz Devices(57GHz to 64Ghz): Valid range: 5700 to 6400 Default value: 5700 (If this API is not issued)
FREQ_LIMIT_LOW_TX1	2	The sensor's lower frequency limit for calibrations and monitoring for TX1 is encoded in 2 bytes (16 bit unsigned number) 1 LSB = 10 MHz For 77GHz Devices(76GHz to 81Ghz): Valid range: 7600 to 8100 Default value: 7600 (If this API is not issued) For 60GHz Devices(57GHz to 64Ghz): Valid range: 5700 to 6400 Default value: 5700 (If this API is not issued)
FREQ_LIMIT_LOW_TX2	2	The sensor's lower frequency limit for calibrations and monitoring for TX2 is encoded in 2 bytes (16 bit unsigned number) 1 LSB = 10 MHz For 77GHz Devices(76GHz to 81Ghz): Valid range: 7600 to 8100 Default value: 7600 (If this API is not issued) For 60GHz Devices(57GHz to 64Ghz): Valid range: 5700 to 6400

Continued on next page

Table 5.11 – continued from previous page

		Default value: 5700 (If this API is not issued)
FREQ_LIMIT_HIGH_TX0	2	<p>The sensor's higher frequency limit for calibrations and monitoring for TX0 is encoded in 2 bytes (16 bit unsigned number)</p> <p>1 LSB = 10 MHz</p> <p>For 77GHz Devices (76GHz to 81Ghz): Valid range: 7600 to 8100 Default value: 8100 (If this API is not issued)</p> <p>For 60GHz Devices (57GHz to 64Ghz): Valid range: 5700 to 6400 Default value: 6400 (If this API is not issued)</p> <p>NOTE: FREQ_LIMIT_HIGH_TXn should be strictly greater than FREQ_LIMIT_LOW_TXn</p>
FREQ_LIMIT_HIGH_TX1	2	<p>The sensor's higher frequency limit for calibrations and monitoring for TX1 is encoded in 2 bytes (16 bit unsigned number)</p> <p>1 LSB = 10 MHz</p> <p>For 77GHz Devices (76GHz to 81Ghz): Valid range: 7600 to 8100 Default value: 8100 (If this API is not issued)</p> <p>For 60GHz Devices (57GHz to 64Ghz): Valid range: 5700 to 6400 Default value: 6400 (If this API is not issued)</p> <p>NOTE: FREQ_LIMIT_HIGH_TXn should be strictly greater than FREQ_LIMIT_LOW_TXn</p>
FREQ_LIMIT_HIGH_TX2	2	<p>The sensor's higher frequency limit for calibrations and monitoring for TX2 is encoded in 2 bytes (16 bit unsigned number)</p> <p>1 LSB = 10 MHz</p> <p>For 77GHz Devices (76GHz to 81Ghz): Valid range: 7600 to 8100 Default value: 8100 (If this API is not issued)</p> <p>For 60GHz Devices (57GHz to 64Ghz): Valid range: 5700 to 6400 Default value: 6400 (If this API is not issued)</p> <p>NOTE: FREQ_LIMIT_HIGH_TXn should be strictly greater than FREQ_LIMIT_LOW_TXn</p>
TX0_POWER_BACKOFF	1	<p>TX0 output power back off</p> <p>1 LSB = 1 dB</p> <p>Valid values: 0, 3, 6, 9</p> <p>Default value: 0</p>
TX1_POWER_BACKOFF	1	<p>TX1 output power back off</p> <p>1 LSB = 1 dB</p> <p>Valid values: 0, 3, 6, 9</p> <p>Default value: 0</p>

Continued on next page

Table 5.11 – continued from previous page

TX2_POWER_BACKOFF	1	TX2 output power back off 1 LSB = 1 dB Valid values: 0, 3, 6, 9 Default value: 0
RESERVED	1	0x00
RESERVED	2	0x0000
RESERVED	2	0x0000
RESERVED	2	0x0000
RESERVED	2	0x0000

NOTE1:	The minimum RF bandwidth 200MHz, this is to perform internal calibration and monitoring.
NOTE2:	The limit set in this API is not applicable for functional chirps and loop-back chirps used in advanced frame config API.
NOTE3:	The TX0 frequency limit is used by default in calibrations and monitors where TX is not relevant or enabled.
NOTE4:	The RF band used in functional chirp profiles shall be within the limit set in this API.
NOTE5:	The mid frequency code of RF band used in functional chirp profiles + 200MHz shall be within the max limit set in this API.

5.2.11 Sub block 0x008B – AWR_CAL_DATA_RESTORE_SB

This sub block restores the calibration data which was stored previously using the [AWR_CAL_DATA_SAVE_SB](#) command. The async event [AWR_AE_RF_INITCALIBSTATUS_SB](#) will be issued after this API, this indicates success of the calibration data restore. The calibration data contents are defined in page 66 in [AWR_CAL_DATA](#) table.

Table 5.12: AWR_CAL_DATA_RESTORE_SB contents

Field Name	Number of bytes	Description
SBLKID	2	Value = 0x008B
SBLKLEN	2	Value = 232
RESERVED	2	0x0000
CHUNK_ID	2	Index of the current chunk Valid range: 0 to 2
CAL_DATA	224	Calibration data chunk which was stored in non-volatile memory

NOTE1:	All 3 chunks of 224 bytes each shall be sent to radar device to complete the restore process and to generate AWR_AE_RF_INITCALIBSTATUS_SB AE.
NOTE2:	Refer recommended API sequence and order in page 270 for more details on sequence of issuing this API.

5.2.12 Sub block 0x008C – AWR_PHASE_SHIFTER_CAL_DATA_RESTORE_SB

This sub block restores the calibration data which was stored previously using the AWR_PHASE_SHIFTER_CAL_DATA_SAVE_SB command. This is device specific feature, please refer data sheet.

Table 5.13: AWR_PHASE_SHIFTER_CAL_DATA_RESTORE_SB contents

Field Name	Number of bytes	Description
SBLKID	2	Value = 0x008C
SBLKLEN	2	Value = 136
TX_INDX	1	Index of the transmit channel for which the following data applies Valid range: 0 to 2
CAL_APPLY	1	Set this to 1 after applying calibration data from all transmitters. This bit will indicate to the firmware to start the correction process.

Continued on next page

Table 5.13 – continued from previous page

OBS_PHSIFT_DATA	128	<p>Observed phase shift corresponding to each desired phase shift. Index n corresponds to desired phase shift of $n \times 5.625^\circ$.</p> <p>For TX0 the mapping is as below:</p> <table border="1" data-bbox="662 459 1257 1025"> <thead> <tr> <th>n</th> <th>Desired phase shift</th> <th>Observed phase shift is injected in the following bytes</th> </tr> </thead> <tbody> <tr><td>47</td><td>264.375°</td><td>byte[1], byte[0]</td></tr> <tr><td>48</td><td>270.0 °</td><td>byte[3], byte[2]</td></tr> <tr><td>⋮</td><td>⋮</td><td></td></tr> <tr><td>62</td><td>348.75 °</td><td>byte[31], byte[30]</td></tr> <tr><td>63</td><td>354.375°</td><td>byte[33], byte[32]</td></tr> <tr><td>0</td><td>0.0 °</td><td>byte[35], byte[34]</td></tr> <tr><td>1</td><td>5.625°</td><td>byte[37], byte[36]</td></tr> <tr><td>⋮</td><td>⋮</td><td></td></tr> <tr><td>45</td><td>253.125°</td><td>byte[125], byte[124]</td></tr> <tr><td>46</td><td>258.75 °</td><td>byte[127], byte[126]</td></tr> </tbody> </table> <p>For TX1 and TX2 the mapping is as below:</p> <table border="1" data-bbox="662 1075 1257 1641"> <thead> <tr> <th>n</th> <th>Desired phase shift</th> <th>Observed phase shift is injected in the following bytes</th> </tr> </thead> <tbody> <tr><td>15</td><td>84.375°</td><td>byte[1], byte[0]</td></tr> <tr><td>16</td><td>90.0 °</td><td>byte[3], byte[2]</td></tr> <tr><td>⋮</td><td>⋮</td><td></td></tr> <tr><td>62</td><td>348.75 °</td><td>byte[31], byte[30]</td></tr> <tr><td>63</td><td>354.375°</td><td>byte[33], byte[32]</td></tr> <tr><td>0</td><td>0.0 °</td><td>byte[35], byte[34]</td></tr> <tr><td>1</td><td>5.625°</td><td>byte[37], byte[36]</td></tr> <tr><td>⋮</td><td>⋮</td><td></td></tr> <tr><td>13</td><td>73.125°</td><td>byte[125], byte[124]</td></tr> <tr><td>14</td><td>78.75 °</td><td>byte[127], byte[126]</td></tr> </tbody> </table> <p>1 LSB = $360^\circ / 2^{10}$</p>	n	Desired phase shift	Observed phase shift is injected in the following bytes	47	264.375°	byte[1], byte[0]	48	270.0 °	byte[3], byte[2]	⋮	⋮		62	348.75 °	byte[31], byte[30]	63	354.375°	byte[33], byte[32]	0	0.0 °	byte[35], byte[34]	1	5.625°	byte[37], byte[36]	⋮	⋮		45	253.125°	byte[125], byte[124]	46	258.75 °	byte[127], byte[126]	n	Desired phase shift	Observed phase shift is injected in the following bytes	15	84.375°	byte[1], byte[0]	16	90.0 °	byte[3], byte[2]	⋮	⋮		62	348.75 °	byte[31], byte[30]	63	354.375°	byte[33], byte[32]	0	0.0 °	byte[35], byte[34]	1	5.625°	byte[37], byte[36]	⋮	⋮		13	73.125°	byte[125], byte[124]	14	78.75 °	byte[127], byte[126]
n	Desired phase shift	Observed phase shift is injected in the following bytes																																																																		
47	264.375°	byte[1], byte[0]																																																																		
48	270.0 °	byte[3], byte[2]																																																																		
⋮	⋮																																																																			
62	348.75 °	byte[31], byte[30]																																																																		
63	354.375°	byte[33], byte[32]																																																																		
0	0.0 °	byte[35], byte[34]																																																																		
1	5.625°	byte[37], byte[36]																																																																		
⋮	⋮																																																																			
45	253.125°	byte[125], byte[124]																																																																		
46	258.75 °	byte[127], byte[126]																																																																		
n	Desired phase shift	Observed phase shift is injected in the following bytes																																																																		
15	84.375°	byte[1], byte[0]																																																																		
16	90.0 °	byte[3], byte[2]																																																																		
⋮	⋮																																																																			
62	348.75 °	byte[31], byte[30]																																																																		
63	354.375°	byte[33], byte[32]																																																																		
0	0.0 °	byte[35], byte[34]																																																																		
1	5.625°	byte[37], byte[36]																																																																		
⋮	⋮																																																																			
13	73.125°	byte[125], byte[124]																																																																		
14	78.75 °	byte[127], byte[126]																																																																		
RESERVED	2	0x0000																																																																		

5.2.13 Sub block 0x008D – AWR_APLL_SYNTH_BW_CONTROL_SB

This is a new feature addition in **xWR6843**. This sub block is used to control bandwidth of the APLL and Synthesizer. The typical recommended settings are as below.

Table 5.14: Typical APLL and Synth BW settings

SYNTH_ICP_TRIM	SYNTH_RZ_TRIM	APLL_ICP_TRIM	APLL_RZ_TRIM_LPF	APLL_VCO_BIAS_RTRIM	VCO1_BW	VCO2_BW	APLL_BW	Emission Improv	1M PN Degradation@60G	100K PN Improv @60G
1	8	0x26	0x9	8	1.5M	1.5M	150K	2dB	2dB	0dB
3	8	0x26	0x9	8	0.75M	0.75M	150K	2dB	2dB	0dB
1	8	0x3F	0x9	8	1.5M	1.5M	300K	2dB	4dB	5dB
1	8	0x26	0x9	5	1.5M	1.5M	150K	8dB	1.5dB	0dB
3	8	0x26	0x9	5	0.75M	0.75M	150K	8dB	1.5dB	0dB
1	8	0x3F	0x9	5	1.5M	1.5M	300K	8dB	3.5dB	5dB
1	8	0x26	0x9	6	1.5M	1.5M	150K	5dB	1dB	0dB
3	8	0x26	0x9	6	0.75M	0.75M	150K	5dB	1dB	0dB
1	8	0x3F	0x9	6	1.5M	1.5M	300K	5dB	3dB	5dB
1	8	0x26	0x9	18	1.5M	1.5M	150K	0dB	0dB	0dB
3	8	0x26	0x9	18	0.75M	0.75M	150K	0dB	0dB	0dB
1	8	0x3F	0x9	18	1.5M	1.5M	300K	0dB	2dB	5dB

Table 5.15: AWR_APLL_SYNTH_BW_CONTROL_SB contents

Field Name	Number of bytes	Description
SBLKID	2	Value = 0x008D
SBLKLEN	2	Value = 20
SYNTH_ICP_TRIM	1	Synth ICP trim code
SYNTH_RZ_TRIM	1	Synth RZ trim code
APLL_ICP_TRIM	1	APLL ICP trim code
APLL_RZ_TRIM_LPF	1	APLL RZ LPF trim code
APLL_RZ_TRIM_VCO	1	APLL RZ VCO trim code
RESERVED	11	0x0000

NOTE: Recommended to issue this AWR_APLL_SYNTH_BW_CONTROL_SB API before AWR_RF_INIT_SB API. The RF_INIT synthesizer boot calibration shall run after changing the APLL BW.

5.3 Sub blocks related to AWR_RF_STATIC_CONF_GET_MSG

5.3.1 Sub block 0x00A0 – 0x00AA – RESERVED

5.3.2 Sub block 0x00AB – AWR_CAL_DATA_SAVE_SB

This sub block reads the calibration data from the device which can be injected later using the AWR_CAL_DATA_RESTORE_SB command.

NOTE: The total size of the calibration data is 672 bytes, this has been split into 3 chunks (NUM_CHUNKS) of 224 bytes each due to SPI limitation. The Host should receive all these 3 chunks from radar device, later host can store only relevant data in non volatile memory.

Table 5.16: AWR_CAL_DATA_SAVE_SB contents

Field Name	Number of bytes	Description
SBLKID	2	Value = 0x00AB
SBLKLEN	2	Value = 8
RESERVED	2	0x0000
CHUNK_ID	2	Index of the requested chunk Valid values: 0 to NUM_CHUNKS - 1

Response to the above command will contain the calibration data which is formatted as shown below

Table 5.17: AWR_CAL_DATA_SAVE_SB response packet contents

Field Name	Number of bytes	Description
SBLKID	2	Value = 0x00AB
SBLKLEN	2	Value = 232
NUM_CHUNKS	2	Total number of calibration data chunks NUM_CHUNKS
CHUNK_ID	2	Current chunk number

Continued on next page

Table 5.17 – continued from previous page

CAL_DATA	224	Calibration data, refer CAL_DATA contents below
----------	-----	-------------------------------------------------

Table 5.18: AWR_CAL_DATA contents

Field Name	Number of bytes	Description
CAL_VALIDITY_STATUS	4	<p>This field indicates the status of each calibration (0 – FAIL, 1 – PASS). If a particular calibration was not enabled, then its corresponding field should be ignored.</p> <p>Bit Definition (0 – FAIL, 1 – PASS)</p> <p>b0 RESERVED</p> <p>b1 APLL tuning (Ignore while store restore)</p> <p>b2 SYNTH VCO1 tuning (Ignore while store restore)</p> <p>b3 SYNTH VCO2 tuning (Ignore while store restore)</p> <p>b4 LODIST calibration (Ignore while store restore)</p> <p>b5 RX ADC DC offset calibration</p> <p>b6 HPF cutoff calibration</p> <p>b7 LPF cutoff calibration</p> <p>b8 Peak detector calibration (optional)</p> <p>b9 TX Power calibration (optional)</p> <p>b10 RX gain calibration</p> <p>b11 TX Phase calibration (optional)</p> <p>b12 RX IQMM calibration</p> <p>b31:13 RESERVED</p> <p>The recommended Validity status bits while restoring is 0x000014E0, assuming only RX_ADC_DC_CAL_DATA, HPF_CAL_DATA, LPF_CAL_DATA, RX_RF_GAIN_CAL_DATA and IQMM_CAL_DATA are stored and restored.</p>
CAL_VALIDITY_STATUS_COPY	4	Redundant CAL_VALIDITY_STATUS value, this value should match with CAL_VALIDITY_STATUS
IF_STAGE_CAL_STATUS	4	<p>This field indicates the status of IF stage calibration (0 – FAIL, 1 – PASS). If a particular calibration was not enabled, then its corresponding field should be ignored.</p> <p>Bit Definition (0 – FAIL, 1 – PASS)</p> <p>b0 HPF1</p> <p>b1 HPF2</p> <p>b2 LPF1</p> <p>b3 LPF2</p> <p>b31:4 RESERVED</p>

		This value shall be set to 0xF if HPF and LPF calibration validity status are PASS
RESERVED	4	RESERVED
CAL_TEMPERA-TURE	2	Temperature at which boot calibration is done
RESERVED	14	RESERVED
RX_ADC_DC_CAL_DATA	16	Rx chain ADC DC calibration data
HPF1_CAL_DATA	1	HPF1 calibration data
HPF2_CAL_DATA	1	HPF2 calibration data
RESERVED	2	RESERVED
LPF1_CAL_DATA	24	LPF1 calibration data
LPF2_CAL_DATA	24	LPF2 calibration data
RX_RF_GAIN_CAL_DATA	12	RX RF gain calibration data
IQMM_CAL_DATA	72	RX IQMM calibration data
TX_POWER_CAL_DATA	84	TX Power calibration data
POWER_DET_CAL_DATA	348	Power detector calibration data
RESERVED	56	RESERVED

AWR6843 calibration data structure:

Table 5.19: AWR_CAL_DATA contents

Field Name	Number of bytes	Description
------------	-----------------	-------------

CAL_VALIDITY_STATUS	4	<p>This field indicates the status of each calibration (0 – FAIL, 1 – PASS). If a particular calibration was not enabled, then its corresponding field should be ignored.</p> <p>Bit Definition (0 – FAIL, 1 – PASS)</p> <p>b0 RESERVED</p> <p>b1 APLL tuning (Ignore while store restore)</p> <p>b2 SYNTH VCO1 tuning (Ignore while store restore)</p> <p>b3 SYNTH VCO2 tuning (Ignore while store restore)</p> <p>b4 LODIST calibration (Ignore while store restore)</p> <p>b5 RX ADC DC offset calibration</p> <p>b6 HPF cutoff calibration</p> <p>b7 LPF cutoff calibration</p> <p>b8 Peak detector calibration (optional)</p> <p>b9 TX Power calibration (optional)</p> <p>b10 RX gain calibration</p> <p>b11 TX Phase calibration (Ignore while store restore)</p> <p>b12 RX IQMM calibration</p> <p>b31:13 RESERVED</p> <p>The recommended Validity status bits while restoring is 0x000014E0, assuming only RX_ADC_DC_CAL_DATA, HPF_CAL_DATA, LPF_CAL_DATA, RX_RF_GAIN_CAL_DATA and IQMM_CAL_DATA are stored and restored.</p>
CAL_VALIDITY_STATUS_COPY	4	Redundant CAL_VALIDITY_STATUS value, this value should match with CAL_VALIDITY_STATUS
RESERVED	8	RESERVED
CAL_TEMPERATURE	2	Temperature at which boot calibration is done
RESERVED	14	RESERVED
RX_ADC_DC_CAL_DATA	16	Rx chain ADC DC calibration data
HPF1_CAL_DATA	1	HPF1 calibration data
HPF2_CAL_DATA	1	HPF2 calibration data
LODIST_BIAS_CODE	1	LODIST calibration data
RESERVED	1	RESERVED
RX_RF_GAIN_CAL_DATA	8	RX RF gain calibration data
IQMM_CAL_DATA	104	RX IQMM calibration data

TX_POWER_CAL_DATA	122	TX Power calibration data
POWER_DET_CAL_DATA	344	Power detector calibration data
RESERVED	42	RESERVED

NOTE1:	Before storing the calibration data in non volatile memory, the host shall make sure validity status of all enabled calibrations are SET to value 1 including APLL, VCO1, VCO2 and LODIST calibration validity in RF_INIT of radar device.
NOTE2:	Host can store only relevant calibration data in non volatile memory and corresponding validity bits shall be set to 1 in AWR_CAL_DATA_RESTORE_SB and rest of the validity bits should be clear to 0 before restoring the data to radar device.
NOTE3:	Host shall ignore APLL, VCO1, VCO2 and LODIST calibration validity bits while restoring, these calibrations will be done in each device power-up.

5.3.3 Sub block 0x00AC – AWR_PHASE_SHIFTER_CAL_DATA_SAVE_SB

This sub block reads the phase shifter calibration data from the device which can be injected later using the AWR_PHASE_SHIFTER_CAL_DATA_RESTORE_SB command. This is device specific feature, please refer data sheet.

Table 5.20: AWR_PHASE_SHIFTER_CAL_DATA_SAVE_SB contents

Field Name	Number of bytes	Description
SBLKID	2	Value = 0x00AC
SBLKLEN	2	Value = 8
TX_INDX	1	Index of the transmitter channel for which the phase shift is desired Valid range: 0 to 2
RESERVED	3	0x000000

Response to the above command will contain the phase shifter calibration data which is formatted as shown below

Table 5.21: AWR_PHASE_SHIFTER_CAL_DATA_SAVE_SB response packet contents

Field Name	Number of bytes	Description
SBLKID	2	Value = 0x00AC
SBLKLEN	2	Value = 136
TX_INDx	1	Index of the transmitter channel for which the following phase shift values applies Valid range: 0 to 2
RESERVED	1	0x00

Continued on next page

Table 5.21 – continued from previous page

OBS_PHSIFT_DATA	128	<p>Observed phase shift corresponding to each desired phase shift. Index n corresponds to desired phase shift of $n \times 5.625^\circ$.</p> <p>For TX0 the mapping is as below:</p> <table border="1" data-bbox="662 459 1257 1025"> <thead> <tr> <th>n</th> <th>Desired phase shift</th> <th>Observed phase shift is injected in the following bytes</th> </tr> </thead> <tbody> <tr><td>47</td><td>264.375°</td><td>byte[1], byte[0]</td></tr> <tr><td>48</td><td>270.0 °</td><td>byte[3], byte[2]</td></tr> <tr><td>⋮</td><td>⋮</td><td></td></tr> <tr><td>62</td><td>348.75 °</td><td>byte[31], byte[30]</td></tr> <tr><td>63</td><td>354.375°</td><td>byte[33], byte[32]</td></tr> <tr><td>0</td><td>0.0 °</td><td>byte[35], byte[34]</td></tr> <tr><td>1</td><td>5.625°</td><td>byte[37], byte[36]</td></tr> <tr><td>⋮</td><td>⋮</td><td></td></tr> <tr><td>45</td><td>253.125°</td><td>byte[125], byte[124]</td></tr> <tr><td>46</td><td>258.75 °</td><td>byte[127], byte[126]</td></tr> </tbody> </table> <p>For TX1 and TX2 the mapping is as below:</p> <table border="1" data-bbox="662 1075 1257 1641"> <thead> <tr> <th>n</th> <th>Desired phase shift</th> <th>Observed phase shift is injected in the following bytes</th> </tr> </thead> <tbody> <tr><td>15</td><td>84.375°</td><td>byte[1], byte[0]</td></tr> <tr><td>16</td><td>90.0 °</td><td>byte[3], byte[2]</td></tr> <tr><td>⋮</td><td>⋮</td><td></td></tr> <tr><td>62</td><td>348.75 °</td><td>byte[31], byte[30]</td></tr> <tr><td>63</td><td>354.375°</td><td>byte[33], byte[32]</td></tr> <tr><td>0</td><td>0.0 °</td><td>byte[35], byte[34]</td></tr> <tr><td>1</td><td>5.625°</td><td>byte[37], byte[36]</td></tr> <tr><td>⋮</td><td>⋮</td><td></td></tr> <tr><td>13</td><td>73.125°</td><td>byte[125], byte[124]</td></tr> <tr><td>14</td><td>78.75 °</td><td>byte[127], byte[126]</td></tr> </tbody> </table> <p>1 LSB = $360^\circ / 2^{10}$</p>	n	Desired phase shift	Observed phase shift is injected in the following bytes	47	264.375°	byte[1], byte[0]	48	270.0 °	byte[3], byte[2]	⋮	⋮		62	348.75 °	byte[31], byte[30]	63	354.375°	byte[33], byte[32]	0	0.0 °	byte[35], byte[34]	1	5.625°	byte[37], byte[36]	⋮	⋮		45	253.125°	byte[125], byte[124]	46	258.75 °	byte[127], byte[126]	n	Desired phase shift	Observed phase shift is injected in the following bytes	15	84.375°	byte[1], byte[0]	16	90.0 °	byte[3], byte[2]	⋮	⋮		62	348.75 °	byte[31], byte[30]	63	354.375°	byte[33], byte[32]	0	0.0 °	byte[35], byte[34]	1	5.625°	byte[37], byte[36]	⋮	⋮		13	73.125°	byte[125], byte[124]	14	78.75 °	byte[127], byte[126]
n	Desired phase shift	Observed phase shift is injected in the following bytes																																																																		
47	264.375°	byte[1], byte[0]																																																																		
48	270.0 °	byte[3], byte[2]																																																																		
⋮	⋮																																																																			
62	348.75 °	byte[31], byte[30]																																																																		
63	354.375°	byte[33], byte[32]																																																																		
0	0.0 °	byte[35], byte[34]																																																																		
1	5.625°	byte[37], byte[36]																																																																		
⋮	⋮																																																																			
45	253.125°	byte[125], byte[124]																																																																		
46	258.75 °	byte[127], byte[126]																																																																		
n	Desired phase shift	Observed phase shift is injected in the following bytes																																																																		
15	84.375°	byte[1], byte[0]																																																																		
16	90.0 °	byte[3], byte[2]																																																																		
⋮	⋮																																																																			
62	348.75 °	byte[31], byte[30]																																																																		
63	354.375°	byte[33], byte[32]																																																																		
0	0.0 °	byte[35], byte[34]																																																																		
1	5.625°	byte[37], byte[36]																																																																		
⋮	⋮																																																																			
13	73.125°	byte[125], byte[124]																																																																		
14	78.75 °	byte[127], byte[126]																																																																		
RESERVED	2	0x0000																																																																		

5.4 Sub blocks related to AWR_RF_INIT_MSG

5.4.1 Sub block 0x00C0 – AWR_RF_INIT_SB

This sub block, needed to be initially issued, triggers one time calibrations such as those related to APLL and synthesizer. The BSS processor is woken up upon receiving this sub block, the RF analog and digital baseband sections are initialized.

Table 5.22 describes the content of this sub block.

Table 5.22: AWR_RF_INIT_SB contents

Field Name	Number of bytes	Description
SBLKID	2	Value = 0x00C0
SBLKLEN	2	Value = 4

NOTE1: This sub block will be acknowledged immediately but an async event [AWR_AE_RF_INITCALIBSTATUS_SB](#) from BSS will indicate that the RF initialization is complete. No commands shall be sent to BSS till the async event is received.

NOTE2: It is not recommended to issue this API in runtime multiple times. This API shall be issued only once after power cycle with or without calibration data restore operation.

NOTE2: The following boot-time calibrations are susceptible to corruption by interference. The calibrations may result in false configuration of the RF analog sections due to corruption by interference during the calibration measurements.

- a. RX gain calibration (susceptible to interference)
- b. RX IQMM calibration (susceptible to interference)
- c. TX Phase calibration (susceptible to interference)

It is recommended to perform factory calibration and store the calibration data in non volatile memory using [AWR_CAL_DATA_SAVE_SB](#) API. This data can be restored to radar device using [AWR_CAL_DATA_RESTORE_SB](#) API. More info related to save restore provided in page [65](#)

5.5 Sub blocks related to AWR_RF_DYNAMIC_CONF_SET_MSG

5.5.1 Sub block 0x0100 – AWR_PROFILE_CONF_SET_SB

This sub block contains FMCW radar chirp profiles or properties (FMCW slope, chirp duration, TX power etc.). Since the device supports multiple profiles, each profile is defined in this sub

block. Internal RF and analog calibrations may be triggered upon receiving this sub block and ASYNC_EVENT response sent once completed.

NOTE: This API can be issued dynamically to change profile parameters. Few parameters which cannot be changed are

1. PF_NUM_ADC_SAMPLES
2. PF_DIGITAL_OUTPUT_SAMPLING_RATE
3. Programmable filter coefficients in xWR1642/xWR6843/xWR1843

Table 5.23 describes the contents of this sub block.

Table 5.23: AWR_PROFILE_CONF_SB contents

Field Name	Number of bytes	Description
SBLKID	2	Value = 0x0100
SBLKLEN	2	Value = 48
PF_INDX	2	The profile index for which the rest of the fields are applicable for

Continued on next page

Table 5.23 – continued from previous page

PF_VCO_SELECT	1	Bit	<p>Description</p> <p>b0 FORCE_VCO_SEL (Not supported for production, debug purpose only)</p> <p>0 Use internal VCO selection</p> <p>1 Forced external VCO selection</p> <p>b1 VCO_SEL (Not supported for production, debug purpose only)</p> <p>0 VCO1 (77G: 76–78GHz, 60G: 57-60.75GHz)</p> <p>1 VCO2 (77G: 77–81GHz, 60G: 60–64GHz)</p> <p>NOTE:</p> <p>1. xWR1xxx devices: There is an overlap region of 77-78 GHz in which any of the VCOs can be used, for other regions use only the VCO which can work in that region. For e.g. for 76-78 GHz use only VCO1 and for 77-81GHz use only VCO2, for 77-78 GHz, any VCO can be used. Also note that users can inter-mix chirps from different VCOs within the same frame. 2. xWR6843 device: There is an overlap region of 60-60.75 GHz in which any of the VCOs can be used.</p> <p>b7:2 RESERVED</p> <p>0b000000</p>
PF_CALLUT_UPDATE	1	Bit	<p>Description</p> <p>b0 RETAIN_TXCAL_LUT</p> <p>0 Update TX calibration LUT</p> <p>1 Do not update TX calibration LUT</p> <p>b1 RETAIN_RXCAL_LUT</p> <p>0 Update RX calibration LUT and update RX IQMM correction</p> <p>1 Do not update RX calibration LUT</p> <p>b7:2 RESERVED (set it to 0b000000)</p> <p>If PF_TX_OUTPUT_POWER_BACKOFF is changed then set RETAIN_TXCAL_LUT to 0, else set it to 1 and if PF_RX_GAIN or if sweep bandwidth is changed, then set RETAIN_RXCAL_LUT to 0 else set them to 1</p>

Continued on next page

Table 5.23 – continued from previous page

PF_FREQ_START_CONST	4	<p>Start frequency for this profile</p> <p>For 77GHz Devices (76GHz to 81Ghz): 1 LSB = $3.6e9/2^{26}$ Hz \approx 53.644 Hz Valid range: 0x5471C71B to 0x5A000000</p> <p>For 60GHz Devices (57GHz to 64Ghz): 1 LSB = $2.7e9/2^{26}$ Hz \approx 40.233 Hz Valid range: 0x5471C71C to 0x5ED097B4</p>										
PF_IDLE_TIME_CONST	4	<p>Idle time for each profile</p> <p>1 LSB = 10 ns Valid range: 0 to 524287</p>										
PF_ADC_START_TIME_CONST	4	<p>Time of starting of ADC capture relative to the knee of the ramp</p> <p>1 LSB = 10 ns Valid range: 0 to 4095</p>										
PF_RAMP_END_TIME	4	<p>End of ramp time relative to the knee of the ramp</p> <p>1 LSB = 10 ns Valid range: 0 to 500000</p> <p>Ensure that the total frequency sweep is either within these ranges: 77G: 76-78 GHz or 77-81 GHz 60G: 57-60.75GHz or 60-64GHz</p>										
PF_TX_OUTPUT_POWER_BACKOFF	4	<table border="0"> <thead> <tr> <th>Bits</th> <th>Description</th> </tr> </thead> <tbody> <tr> <td>b7:0</td> <td>TX0 output power back off</td> </tr> <tr> <td>b15:8</td> <td>TX1 output power back off</td> </tr> <tr> <td>b23:16</td> <td>TX2 output power back off</td> </tr> <tr> <td>b31:24</td> <td>RESERVED (set it to 0x00)</td> </tr> </tbody> </table> <p>This field defines how much the transmit power should be reduced from the maximum.</p> <p>1 LSB = 1 dB Valid Range: 0 to 20</p> <p>If Tx power boot time calibration is disabled then only 0dB back off is supported.</p> <p>0dB back-off corresponds to typically 12dBm power level in 1st gen xWR1xxx devices. 0dB back-off corresponds to typically 13dBm power level in xWR6843 devices.</p>	Bits	Description	b7:0	TX0 output power back off	b15:8	TX1 output power back off	b23:16	TX2 output power back off	b31:24	RESERVED (set it to 0x00)
Bits	Description											
b7:0	TX0 output power back off											
b15:8	TX1 output power back off											
b23:16	TX2 output power back off											
b31:24	RESERVED (set it to 0x00)											

Continued on next page

Table 5.23 – continued from previous page

Register Name	Width (bits)	Bits	Description
PF_TX_PHASE_SHIFTER	4	b1:0 b7:2 b9:8 b15:10 b17:16 b23:18 b31:24	RESERVED (set it to 0b00) TX0 phase shift value 1 LSB = $360^\circ/2^6 \approx 5.625^\circ$ RESERVED (set it to 0b00) TX1 phase shift value 1 LSB = $360^\circ/2^6 \approx 5.625^\circ$ RESERVED (set it to 0b00) TX2 phase shift value 1 LSB = $360^\circ/2^6 \approx 5.625^\circ$ RESERVED 0x00 This field defines the additional phase shift to be introduced on each transmitter output. This option is supported only on selected device variants, Please refer data sheet. NOTE: Chirps corresponding to different profiles are not guaranteed to have phase coherency.
PF_FREQ_SLOPE_CONST	2		Frequency slope for each profile is encoded in 2 bytes (16 bit signed number) For 77GHz Devices (76GHz to 81Ghz): 1 LSB = $3.6e9 \times 900/2^{26}$ Hz ≈ 48.279 kHz/ μ s Valid range: -2072 to 2072 For 60GHz Devices (57GHz to 64Ghz): 1 LSB = $2.7e9 \times 900/2^{26}$ Hz ≈ 36.21 kHz/ μ s Valid range: Only even numbers in the range -6905 to 6905 (250MHz/ μ s) Note: Refer AWR_APLL_SYNTH_BW_CONTROL_SB BW control API for constraints on max slope.
PF_TX_START_TIME	2		Time of start of transmitter relative to the knee of the ramp 1 LSB = 10 ns Valid range: -4096 to 4095 Positive numbers refer to start of TX after knee of the ramp and negative numbers refer to start of TX before the knee of the ramp.
PF_NUM_ADC_SAMPLES	2		Number of ADC samples to capture in a chirp for each RX

Continued on next page

Table 5.23 – continued from previous page

		<p>Valid range: 2 to MAX_NUM_SAMPLES, where MAX_NUM_SAMPLES is such that all the enabled RX channels' data fits into 16 kB memory in AWR1243/xWR1443 or 32 kB memory in xWR1642/xWR6843/xWR1843, with each sample consuming 2 bytes for real ADC output case and 4 bytes for complex 1x and complex 2x ADC output cases. For example in AWR1243/ xWR1443 when the ADC buffer size is 16 kB</p> <table border="1"> <thead> <tr> <th>Number of RX chains</th> <th>ADC format</th> <th>MAX_NUM_SAMPLES</th> </tr> </thead> <tbody> <tr> <td>4</td> <td>Complex</td> <td>1024</td> </tr> <tr> <td>4</td> <td>Real</td> <td>2048</td> </tr> <tr> <td>2</td> <td>Complex</td> <td>2048</td> </tr> <tr> <td>2</td> <td>Real</td> <td>4096</td> </tr> </tbody> </table>	Number of RX chains	ADC format	MAX_NUM_SAMPLES	4	Complex	1024	4	Real	2048	2	Complex	2048	2	Real	4096
Number of RX chains	ADC format	MAX_NUM_SAMPLES															
4	Complex	1024															
4	Real	2048															
2	Complex	2048															
2	Real	4096															
PF_DIGITAL_OUTPUT_SAMPLING_RATE	2	<p>ADC Sampling rate for this profile is encoded in 2 bytes (16 bit unsigned number) 1 LSB = 1 ksp/s Valid range: xWR1xxx devices: 2000 to 37500 (Max 15MHz IF bandwidth) xWR6x43 devices: 2000 to 25000 (Max 10MHz IF bandwidth)</p>															
PF_HPF1_CORNER_FREQ	1	<p>HPF1 corner frequency for each profile is encoded in 1 byte Value HPF1 corner frequency definition 0x00 175 kHz 0x01 235 kHz 0x02 350 kHz 0x03 700 kHz</p>															
PF_HPF2_CORNER_FREQ	1	<p>HPF2 corner frequency for each profile is encoded in 1 byte Value HPF2 corner frequency definition 0x00 350 kHz 0x01 700 kHz 0x02 1.4 MHz 0x03 2.8 MHz</p>															

Continued on next page

Table 5.23 – continued from previous page

TX_CAL_EN_CFG	2	<p>Number of transmitters to turn on during TX power calibration. During actual operation, if more than 1 TXs are enabled during the chirp, then enabling the same TXs during calibration will have better TX output power accuracy</p> <p>Bit Definition</p> <p>b2:0 TX enabled during TX0 calibration b0 - TX0, b1 - TX1, b2 - TX2</p> <p>b5:3 TX enabled during TX1 calibration b3 - TX0, b4 - TX1, b5 - TX2</p> <p>b8:6 TX enabled during TX2 calibration b6 - TX0, b7 - TX1, b8 - TX2</p> <p>b14:9 RESERVED</p> <p>b15 Enable multi TX enable during TX power calibration</p> <p>If this bit is not set, only 1 TX is enabled during the TX power calibration. For e.g. during TX0 calibration, only TX0 will be enabled; during TX1 calibration, only TX1 will be enabled and so on</p>
---------------	---	-----------------------------------------------------------------------------------------------------------------------------------------------------------------------------------------------------------------------------------------------------------------------------------------------------------------------------------------------------------------------------------------------------------------------------------------------------------------------------------------------------------------------------------------------------------------------------------------------------------------------------------------------------------------------------------------------------------------------------------------------------------------------------------------------------------------------------------------

Continued on next page

Table 5.23 – continued from previous page

PF_RX_GAIN	2	<p>Bit Definition</p> <p>b5:0 RX_GAIN</p> <p>This field defines RX gain for each channel.</p> <p>1 LSB = 1 dB</p> <p>Valid values:</p> <p>xWR1xxx devices - all even values from 24 to 52</p> <p>xWR6x43 devices - all even values from 30 to 48</p> <p>b7:6 RF_GAIN_TARGET (NA for IWR6843 ES1.0, RF gain is fixed to 34 dB)</p> <p>AWR12xx, xWR14xx, xWR16xx, xWR18xx:</p> <table border="0"> <tr> <td>Value</td> <td>RF gain target</td> </tr> <tr> <td>00</td> <td>30 dB</td> </tr> <tr> <td>01</td> <td>34 dB</td> </tr> <tr> <td>10</td> <td>RESERVED</td> </tr> <tr> <td>11</td> <td>26 dB</td> </tr> </table> <p>xWR6843 ES2:</p> <table border="0"> <tr> <td>Value</td> <td>RF gain target</td> </tr> <tr> <td>00</td> <td>30 dB</td> </tr> <tr> <td>01</td> <td>33 dB</td> </tr> <tr> <td>10</td> <td>36 dB</td> </tr> <tr> <td>11</td> <td>RESERVED</td> </tr> </table> <p>b15:8 RESERVED (set it to 0x00)</p> <p>The total RX gain is achieved as a sum of RF gain and IF amplifiers gain. The RF Gain target allows the user to control the RF gain independently from the total RX gain, thus giving flexibility to the user to trade-off linearity vs. noise figure. Out of multiple gain settings for the RF stages, the firmware calibration algorithm uses the one that makes the RF gain as close as possible to the user programmed RF Gain Target.</p> <p>In AWR6843 ES1.0 device, Rx Gain is not accurate and not calibrated. The RF gain is 34dB and total Rx gain can be varied from 28dB to 56dB</p>	Value	RF gain target	00	30 dB	01	34 dB	10	RESERVED	11	26 dB	Value	RF gain target	00	30 dB	01	33 dB	10	36 dB	11	RESERVED
Value	RF gain target																					
00	30 dB																					
01	34 dB																					
10	RESERVED																					
11	26 dB																					
Value	RF gain target																					
00	30 dB																					
01	33 dB																					
10	36 dB																					
11	RESERVED																					
RESERVED	2	0x0000																				

NOTE1:	Please refer Table 11.1 for details on minimum chirp duration.
NOTE2:	The max TX output power back-off only up to 20dB is supported.
NOTE3:	The RF band used in functional chirp profiles shall be within the limit set in AWR_CAL_MON_FREQUENCY_TX_POWER_LIMITS_SB API.
NOTE4:	This API takes around 700us to execute in RadarSS sub System.
NOTE5:	Phase shifter(PS) settings are applied at the knee of the ramp.
NOTE6:	The mid frequency code of RF band used in functional chirp profiles + 200MHz shall be within the max limit set in this API.

Table 5.24: Note on maximum sampling rate

NOTE:

The maximum sampling rate supported is limited based on the information in the table below

When device supports 15 MHz IF bandwidth (refer device data sheet)

	Real/Pseudo Real	Complex1x	Complex2x
Regular ADC mode	37.5 Msps	18.75 Msps	37.5 Msps
Low power ADC mode	18.75 Msps	9.375 Msps	18.75 Msps

When device supports 10 MHz IF bandwidth (refer device data sheet)

	Real/Pseudo Real	Complex1x	Complex2x
Regular ADC mode	25 Msps	12.5 Msps	25 Msps
Low power ADC mode	18.75 Msps	9.375 Msps	18.75 Msps

When device supports 5 MHz IF bandwidth (refer device data sheet)

	Real/Pseudo Real	Complex1x	Complex2x
Regular ADC mode	12.5 Msps	6.25 Msps	12.5 Msps
Low power ADC mode	12.5 Msps	6.25 Msps	12.5 Msps

- The IF bandwidth here refers to the IF frequency of the farthest reflection desired to be detected
- Typically, the IF frequency range preserved well in the receiver baseband is $0.9 \times$ Sampling Rate in Complex 1x and $0.45 \times$ Sampling Rate in Complex 2x and Real/Pseudo Real.
- The maximum sampling rates are also subject to restrictions from LVDS/CSI2 interface rate and ADC bits configurations. Typically in Complex2x mode, the maximum sampling rate would be 25 Msps

5.5.2 Sub block 0x0101 – AWR_CHIRP_CONF_SET_SB

This sub block contains chirp to chirp variations on top of the chirp profiles defined in the AWR_PROFILE_CONF_SET_SB. E.g. which profile is to be used for each chirp in a frame, and small dithers in FMCW start frequency and idle time for each chirp are possible to be defined here. The dithers used in this configuration sub block are only additive on top of programmed parameters in AWR_PROFILE_CONF_SET_SB.

Table 5.25 describes the contents of this sub block.

Table 5.25: AWR_CHIRP_CONF_SET_SB contents

Field Name	Number of bytes	Description
SBLKID	2	Value = 0x0101
SBLKLEN	2	Value = 24
CHIRP_START_INDXX	2	Valid range 0 to 511
CHIRP_END_INDXX	2	Valid range CHIRP_START_INDXX to 511
PROFILE_INDXX	2	Valid range 0 to 3
RESERVED	2	0x0000
CHIRP_FREQ_START_VAR	4	For 77GHz Devices (76GHz to 81GHz): 1 LSB = $3.6e9/2^{26} \approx 53.644$ Hz Valid range: 0 to 8388607 (450MHz) For 60GHz Devices (57GHz to 64Ghz): 1 LSB = $2.7e9/2^{26} \approx 40.23$ Hz Valid range: 0 to 8388607 (337.5MHz)
CHIRP_FREQ_SLOPE_VAR	2	For 77GHz Devices (76GHz to 81GHz): 1 LSB = $3.6e9 \times 900/2^{26} \approx 48.279$ kHz Valid range: 0 to 63 (3MHz/us) For 60GHz Devices (57GHz to 64Ghz): 1 LSB = $2.7e9 \times 900/2^{26} \approx 36.21$ Hz Valid range: Only even numbers between 0 to 63 (2.3MHz/us)
CHIRP_IDLE_TIME_VAR	2	Idle time of each chirp is encoded in 2 bytes (16 bit unsigned number) 1 LSB = 10 ns Valid range: 0 to 4095
CHIRP_ADC_START_TIME_VAR	2	ADC start time of each chirp is encoded in 2 bytes (16 bit unsigned number) 1 LSB = 10 ns Valid range: 0 to 4095

Continued on next page

Table 5.25 – continued from previous page

CHIRP_TX_EN	2	TX enable selection Bit Definition b0 TX0 Enable b1 TX1 Enable b2 TX2 Enable b15:3 RESERVED 0b0_0000_0000_0000 NOTE: Maximum number of TXs that can be turned on in a chirp depends on the device data sheet specification
-------------	---	--------------------------------------------------------------------------------------------------------------------------------------------------------------------------------------------------------------------------------------------------------

5.5.3 Sub block 0x0102 – AWR_FRAME_CONF_SET_SB

This sub block defines a frame, i.e. a sequence of chirps to be transmitted subsequently, the no. of frames to be transmitted, frame periodicity and how to trigger them.

Table 5.26 describes the contents of this sub block.

Table 5.26: AWR_FRAME_CONF_SET_SB contents

Field Name	Number of bytes	Description
SBLKID	2	Value = 0x0102
SBLKLEN	2	Value = 28
RESERVED	2	May use to indicate Frame mode or Continuous chirping mode of operation.
CHIRP_START_INDXX	2	Valid range 0 to 511
CHIRP_END_INDXX	2	Valid range CHIRP_START_INDXX to 511
NUM_LOOPS	2	Number of times to repeat from CHIRP_START_INDXX to CHIRP_END_INDXX in each frame Valid range 1 to 255
NUM_FRAMES	2	Number of frames to transmit 16 bit unsigned number Valid range: 0 to 65535 (0 for infinite frames)
RESERVED	2	0x0000

Continued on next page

Table 5.26 – continued from previous page

FRAME_PERIODICITY	4	<p>PERIOD \geq Sum total time of all chirps + <i>InterFrameBlankTime</i>, where, Sum total time of all chirps = Num Loops * Num chirps * Chirp Period. <i>InterFrameBlankTime</i> is primarily for sensor calibration/monitoring, thermal control, transferring out any safety monitoring data if requested, hardware reconfiguration for next frame, re triggering of next frame. InterFrameBlankTime \geq 300 μs typical, refer a NOTE end of this API for more info. Add 150 μs to <i>InterFrameBlankTime</i> if data-path reconfiguration needed in frame boundary due to change in profile. 1 LSB = 5 ns Valid range 300 μs to 1.342 s</p>						
TRIGGER_SELECT	2	<table border="0"> <thead> <tr> <th>Value</th> <th>Definition</th> </tr> </thead> <tbody> <tr> <td>0x0001</td> <td>SWTRIGGER (Software API based triggering): Frame is triggered upon receiving AWR_FRAMESTARTSTOP_CONF_SB. There could be several tens of micro seconds uncertainty in triggering. This mode is not applicable if this device is configured as MULTICHIP_SLAVE in AWR_CHAN_CONF_SB.</td> </tr> <tr> <td>0x0002</td> <td>HWTRIGGER (Hardware SYNC_IN based triggering): Each frame is triggered by rising edge of pulse in SYNC_IN pin, after receiving AWR_FRAMESTARTSTOP_CONF_SB (this is to prevent spurious transmission). W.r.t. the SYNC_IN pulse, the actual transmission has 160ns delay and 5ns uncertainty in SINGLECHIP and only a 300 ps uncertainty (due to tight inter-chip synchronization needed) in MULTICHIP sensor applications as defined in AWR_CHAN_CONF_SB. For more details please refer to device datasheet.</td> </tr> </tbody> </table>	Value	Definition	0x0001	SWTRIGGER (Software API based triggering): Frame is triggered upon receiving AWR_FRAMESTARTSTOP_CONF_SB. There could be several tens of micro seconds uncertainty in triggering. This mode is not applicable if this device is configured as MULTICHIP_SLAVE in AWR_CHAN_CONF_SB.	0x0002	HWTRIGGER (Hardware SYNC_IN based triggering): Each frame is triggered by rising edge of pulse in SYNC_IN pin, after receiving AWR_FRAMESTARTSTOP_CONF_SB (this is to prevent spurious transmission). W.r.t. the SYNC_IN pulse, the actual transmission has 160ns delay and 5ns uncertainty in SINGLECHIP and only a 300 ps uncertainty (due to tight inter-chip synchronization needed) in MULTICHIP sensor applications as defined in AWR_CHAN_CONF_SB. For more details please refer to device datasheet.
Value	Definition							
0x0001	SWTRIGGER (Software API based triggering): Frame is triggered upon receiving AWR_FRAMESTARTSTOP_CONF_SB. There could be several tens of micro seconds uncertainty in triggering. This mode is not applicable if this device is configured as MULTICHIP_SLAVE in AWR_CHAN_CONF_SB.							
0x0002	HWTRIGGER (Hardware SYNC_IN based triggering): Each frame is triggered by rising edge of pulse in SYNC_IN pin, after receiving AWR_FRAMESTARTSTOP_CONF_SB (this is to prevent spurious transmission). W.r.t. the SYNC_IN pulse, the actual transmission has 160ns delay and 5ns uncertainty in SINGLECHIP and only a 300 ps uncertainty (due to tight inter-chip synchronization needed) in MULTICHIP sensor applications as defined in AWR_CHAN_CONF_SB. For more details please refer to device datasheet.							
RESERVED	1	0x00						
NUM_OF_DUMMY_CHIRPS_AT_THE_END	1	<p>Number of dummy chirps which will run in the rampgen at the end of the frame. The ADC data, CP and CQ data for these chirps will not be sent out from the device/DFE. 1LSB = 1 dummy chirp in the end of frame Valid Range: 0 to 128 (should be less than the total number of chirps in a frame)</p>						

Continued on next page

Table 5.26 – continued from previous page

FRAME_TRIGGER_DELAY	4	<p>Optional time delay from the SYNC_IN trigger to the occurrence of frame chirps. Applicable only in SINGLECHIP sensor applications, as defined in AWR_CHAN_CONF_SB. It is recommended only for staggering the transmission of multiple radar sensors around the car for interference avoidance, if needed.</p> <p>Typical range is 0 to 100 micro seconds.</p> <p>Units: 1 LSB = 5 ns</p>
---------------------	---	---------------------------------------------------------------------------------------------------------------------------------------------------------------------------------------------------------------------------------------------------------------------------------------------------------------------------------------------------------------------------------------------

NOTE1:	If hardware triggered mode is used, the SYNC_IN pulse width should be less than 1 us. Also, the minimum pulse width of SYNC_IN should be 25 ns.
NOTE2:	If frame trigger delay is used with hardware triggered mode, then external SYNC_IN pulse periodicity should take care of the configured frame trigger delay and frame periodicity. The external pulse should be issued only after the sum total of frame trigger delay and frame periodicity. See figure below
NOTE3:	If dummy chirp is used then programmer should make sure the idle time of dummy chirp $\geq 4\mu s + \text{DFE spill over time of previous chirp}$ (calculate from rampgen calculator). The first chirp of frame can not be a dummy chirp.
NOTE4:	In Hw triggered mode, the Hw pulse should be issued or periodicity of pulse is configured such that, the pulse is generated only 150us after the completion of previous frame/burst (The pulse should not be issued before end of previous frame/burst). The time delta between end of previous frame/burst and raising edge of Hw pulse recommended to be $< 300\mu s$.
NOTE5:	The PF_NUM_ADC_SAMPLES parameter should be identical across chirps in a frame, when multiple profiles are used in a frame.
NOTE6:	The PF_DIGITAL_OUTPUT_SAMPLING_RATE impacts the LVD-S/CSI2 data rate in a frame, so it is recommended to analyze timing impact if different sample rate is used across chirps in a frame.
NOTE7:	Please refer Table 11.3 for details on minimum inter-frame blank time requirements.

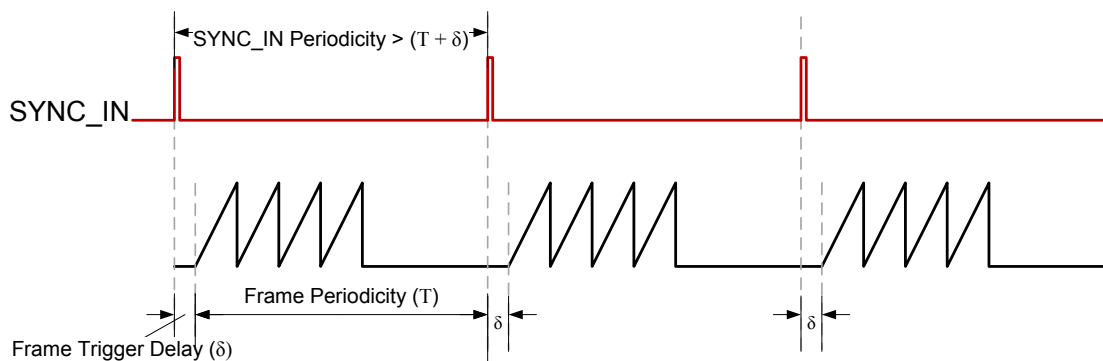

Figure 5.1: Frame trigger delay in case of external hardware trigger

5.5.4 Sub block 0x0103 – AWR_CONT_STREAMING_MODE_CONF_SET_SB

This sub block contains configuration needed to enable continuous streaming mode from the device.

NOTE: The continuous streaming mode configuration APIs are supported only for debug purpose. Please refer latest DFP release note for more info.

Table 5.27 describes the contents of this sub block.

Table 5.27: AWR_CONT_STREAMING_MODE_CONF_SET_SB contents

Field Name	Number of bytes	Description
SBLKID	2	Value = 0x0103
SBLKLEN	2	Value = 24
PF_FREQ_START_CONST	4	Frequency start for each profile is encoded in 4 bytes (32 bit unsigned number) For 77GHz Devices (76GHz to 81GHz): 1 LSB = $3.6e9/2^{26}$ Hz \approx 53.644 Hz Valid range: 0 to 0x7FFFFFFF For 60GHz Devices (57GHz to 64GHz): 1 LSB = $2.7e9/2^{26}$ Hz \approx 40.23 Hz Valid range: 0 to 0x7FFFFFFF

Continued on next page

Table 5.27 – continued from previous page

PF_TX_OUTPUT_POWER_BACKOFF	4	Bits Description b7:0 TX0 output power back off b15:8 TX1 output power back off b23:16 TX2 output power back off b31:24 RESERVED (set it to 0x00) This field defines how much the transmit power should be reduced from the maximum. 1 LSB = 1 dB
PF_TX_PHASE_SHIFTER	4	Bits Description b1:0 RESERVED (set it to 0b00) b7:2 TX0 phase shift value 1 LSB = $360^\circ/2^6 \approx 5.625^\circ$ b9:8 RESERVED (set it to 0b00) b15:10 TX1 phase shift value 1 LSB = $360^\circ/2^6 \approx 5.625^\circ$ b17:16 RESERVED (set it to 0b00) b23:18 TX2 phase shift value 1 LSB = $360^\circ/2^6 \approx 5.625^\circ$ b31:24 RESERVED 0x00 This field defines the additional phase shift to be introduced on each transmitter output. In IWR6843 ES1.0, only 0 degree phase is supported.
PF_DIGITAL_OUTPUT_SAMPLING_RATE	2	ADC Sampling rate for each profile is encoded in 2 bytes (16 bit unsigned number) 1 LSB = 1 ksps Valid range 2000 to 37500
PF_HPF1_CORNER_FREQ	1	HPF1 corner frequency for each profile is encoded in 1 byte Value HPF1 corner frequency definition 0x00 175 kHz 0x01 235 kHz 0x02 350 kHz 0x03 700 kHz

Continued on next page

Table 5.27 – continued from previous page

PF_HPF2_CORNER_FREQ	1	<p>HPF2 corner frequency for each profile is encoded in 1 byte</p> <p>Value HPF2 corner frequency definition</p> <p>0x00 350 kHz</p> <p>0x01 700 kHz</p> <p>0x02 1.4 MHz</p> <p>0x03 2.8 MHz</p>
PF_RX_GAIN	1	<p>This field defines RX gain for continuous streaming mode.</p> <p>Bit Definition</p> <p>5:0 RX_GAIN This field defines RX gain for each profile. 1 LSB = 1 dB Valid values:</p> <p>xWR1xx devices - all even values from 24 to 52 xWR6x43 devices - all even values from 30 to 48</p> <p>7:6 RF_GAIN_TARGET (NA for IWR6843 ES1.0, In IWR6843 ES1.0 RF gain is fixed to 36 dB) AWR12xx, AWR14xx, AWR16xx, AWR18xx:</p> <p>Value RF gain target</p> <p>00 30 dB</p> <p>01 34 dB</p> <p>10 RESERVED</p> <p>11 26 dB</p> <p>xWR6843 ES2:</p> <p>Value RF gain target</p> <p>00 30 dB</p> <p>01 33 dB</p> <p>10 36 dB</p> <p>11 RESERVED</p> <p>Refer Profile configuration API for more info.</p>

Continued on next page

Table 5.27 – continued from previous page

VCO_SELECT	1	Bit	Description
		b0	FORCE_VCO_SEL
		0	Use internal VCO selection
		1	Forced external VCO selection
		b1	VCO_SEL
		0	VCO1 (77G: 76 – 78 GHz, 60G: 57 - 60.75GHz)
		1	VCO2 (77G: 77 – 81 GHz, 60G: 60 – 64GHz)
		b7:2	RESERVED
			0b00_0000
RESERVED	2	0x0000	

NOTE: Continuous streaming (CW) mode is useful for RF lab characterization and debug. In this mode, the device is configured to transmit a single continuous wave (CW - 0 slope) tone at a specific RF frequency continuously.

5.5.5 Sub block 0x0104 – AWR_CONT_STREAMING_MODE_EN_SB

This sub block contains configuration needed to enable continuous streaming mode from the device.

Table 5.28 describes the contents of this sub block.

Table 5.28: AWR_CONT_STREAMING_MODE_EN_SB contents

Field Name	Number of bytes	Description
SBLKID	2	Value = 0x0104
SBLKLEN	2	Value = 8
CONT_STREAMING_EN	2	Value Definition 0x0000 Disable continuous streaming mode 0x0001 Enable continuous streaming mode
RESERVED	2	0x0000

5.5.6 Sub block 0x0105 – AWR_ADVANCED_FRAME_CONF_SB

This sub block contains advanced frame configuration options.

Table 5.29 describes the contents of this sub block.

Table 5.29: AWR_ADVANCED_FRAME_CONF_SB contents

Field Name	Number of bytes	Description
SBLKID	2	Value = 0x0105
SBLKLEN	2	Value = 152
NUM_SUB-FRAMES	1	Number of sub frames enabled in this frame Valid range: 1 to 4
FORCE_SINGLE_PROFILE	1	Value Definition 0x0 The profile index set in Chirp Config API message governs which profile is used when that chirp is transmitted 0x1 The profile index indicated in Chirp Config message is ignored and all the chirps in each sub frame use a single profile as indicated by that sub frame's profile index set in this message. NOTE: This Field is not used/applicable for loop-back sub-frame.
LOOPBACK_CFG	1	Bit Definition b0 LOOPBACK_CFG_EN 0 Disable 1 Enable b2:1 SUB_FRAME_ID Sub frame ID for which the loop-back configuration applies b7:3 RESERVED
SUB_FRAMETRIGGER	1	0 Disabled (default mode, i.e no trigger is required in Frame SW triggered mode and a pulse trigger is required for every burst start in frame hardware triggered mode) 1 Enabled (Need to trigger each sub-frame either by SW in software triggered mode through AWR_SUBFRAME_START_CONF_SB API or HW pulse in hardware triggered mode)
SF1_PROFILE_INDX	2	This is applicable only if FORCE_SINGLE_PROFILE is set to 1. Please refer to that field for description. Valid range: 0 to 3 Not applicable for loop-back sub-frame
SF1_CHIRP_START_INDX	2	Start index of the first chirp for the first burst in sub frame 1 Valid range: 0 to 511 Not applicable for loop-back sub-frame

Continued on next page

Table 5.29 – continued from previous page

SF1_NUM_UNIQUE_CHIRPS_PER_BURST	2	Number of unique chirps per burst Valid range: 1 to 512 Not applicable for loop-back sub-frame
SF1_NUM_LOOPS_PER_BURST	2	Number of times to loop through the unique chirps in each burst, without gaps, using HW. Valid range: 1 to 255
SF1_BURST_PERIOD	4	$BURST_PERIOD \geq (NUM_LOOPS_PER_BURST \times (\text{Sum total of all unique chirp times per burst}) + InterBurstBlankTime)$, where <i>InterBurstBlankTime</i> is primarily for sensor calibration / monitoring, thermal control, and some minimum time needed for triggering next burst. <i>InterBurstBlankTime</i> $\geq 100 \mu s$ typical, refer a NOTE end of this API for more info. NOTE: Across bursts, if the value (Sum total of all unique chirp times per burst), is not a constant, then the actual available blank time can vary and needs to be accounted for. 1 LSB = 5 ns Valid range: 100 μs to 1.342 s
SF1_CHIRP_START_INDX_OFFSET	2	The chirp start index for each burst is determined as the chirp start index of the previous burst plus SFx_START_INDX_OFFSET \times BURST_INDX i.e. $CHIRP_START_INDX = SFx_CHIRP_START_INDX + (SFx_CHIRP_START_INDX_OFFSET \times BURST_INDEX)$ Valid range: 0 to 511 A value of 0 can be used to repeat the same set of unique chirps across bursts. Non-zero values allow spanning a larger number of unique chirps (across bursts). This field Not applicable for loop-back sub-frame
SF1_NUM_BURSTS	2	Number of bursts constituting this sub frame Valid range: 1 to 512 Valid range: 1 to 16 for loop-back sub-frame
SF1_NUM_OUTER_LOOPS	2	Number of times to loop over the set of above defined bursts, for this sub frame. Valid range: 1 to 64 This filed is Not applicable for loop-back sub-frame
RESERVED	2	0x0000

Continued on next page

Table 5.29 – continued from previous page

SF1_PERIOD	4	<p>PERIOD \geq Sum total time of all bursts + <i>InterSubFrameBlankTime</i>, where, Sum total time of all bursts = Num Outer Loops * Num Bursts * Burst Period.</p> <p><i>InterSubFrameBlankTime</i> is primarily for sensor calibration/monitoring, thermal control, transferring out any safety monitoring data if requested, hardware reconfiguration for next sub frame, retriggering of next SF.</p> <p><i>InterSubFrameBlankTime</i> \geq 300 μs typical, refer a NOTE end of this API for more info.</p> <p>Add 150 μs to <i>InterSubFrameBlankTime</i> if data-path re-configuration needed in sub-frame boundary due to change in profile.</p> <p>1 LSB = 5 ns Valid range 300 μs to 1.342 s</p>
RESERVED	4	0x00000000
RESERVED	4	0x00000000
SF2_PROFILE_INDXX	2	<p>This is applicable only if FORCE_SINGLE_PROFILE is set to 1. Please refer to that field for description.</p> <p>Valid range: 0 to 3</p>
SF2_CHIRP_START_INDXX	2	<p>Start index of the first chirp for the first burst in sub frame 2</p> <p>Valid range: 0 to 511</p>
SF2_NUM_UNIQUE_CHIRPS_PER_BURST	2	<p>Number of unique chirps per burst</p> <p>Valid range: 1 to 512</p>
SF2_NUM_LOOPS_PER_BURST	2	<p>Number of times to loop through the unique chirps in each burst, without gaps, using HW.</p> <p>Valid range: 1 to 255</p>
SF2_BURST_PERIOD	4	<p>BURST_PERIOD \geq (NUM_LOOPS_PER_BURST \times (Sum total of all unique chirp times per burst) + <i>InterBurstBlankTime</i>, where <i>InterBurstBlankTime</i> is primarily for sensor calibration / monitoring, thermal control, and some minimum time needed for triggering next burst.</p> <p><i>InterBurstBlankTime</i> \geq 100 μs typical, refer a NOTE end of this API for more info.</p> <p>NOTE: Across bursts, if the value (Sum total of all unique chirp times per burst), is not a constant, then the actual available blank time can vary and needs to be accounted for.</p> <p>1 LSB = 5 ns Valid range: 100 μs to 1.342 s</p>

Continued on next page

Table 5.29 – continued from previous page

SF2_CHIRP_START_INDX_OFFSET	2	The chirp start index for each burst is determined as the chirp start index of the previous burst plus SFx_START_INDX_OFFSET * BURST_INDX i.e. $CHIRP_START_INDX = SFx_CHIRP_START_INDX + (SFx_CHIRP_START_INDX_OFFSET \times BURST_INDEX)$ Valid range: 0 to 511 A value of 0 can be used to repeat the same set of unique chirps across bursts. Non-zero values allow spanning a larger number of unique chirps (across bursts). This field Not applicable for loop-back sub-frame
SF2_NUM_BURSTS	2	Number of bursts constituting this sub frame Valid range: 1 to 512 Valid range: 1 to 16 for loop-back sub-frame
SF2_NUM_OUTER_LOOPS	2	Number of times to loop over the set of above defined bursts, for this sub frame. Valid range: 1 to 64 This field is Not applicable for loop-back sub-frame
RESERVED	2	0x0000
SF2_PERIOD	4	$PERIOD \geq \text{Sum total time of all bursts} + \text{InterSubFrameBlankTime}$, where, $\text{Sum total time of all bursts} = \text{Num Outer Loops} * \text{Num Bursts} * \text{Burst Period}$. <i>InterSubFrameBlankTime</i> is primarily for sensor calibration/monitoring, thermal control, transferring out any safety monitoring data if requested, hardware reconfiguration for next sub frame, retriggering of next SF. $\text{InterSubFrameBlankTime} \geq 300 \mu\text{s}$ typical, refer a NOTE end of this API for more info. Add $150 \mu\text{s}$ to <i>InterSubFrameBlankTime</i> if data-path re-configuration needed in sub-frame boundary due to change in profile. 1 LSB = 5 ns Valid range $300 \mu\text{s}$ to 1.342 s
RESERVED	4	0x00000000
RESERVED	4	0x00000000
SF3_PROFILE_INDX	2	This is applicable only if FORCE_SINGLE_PROFILE is set to 1. Please refer to that field for description. Valid range: 0 to 3
SF3_CHIRP_START_INDX	2	Start index of the first chirp in this sub frame Valid range: 0 to 511 This field Not applicable for loop-back sub-frame

Continued on next page

Table 5.29 – continued from previous page

SF3_NUM_UNIQUE_CHIRPS_PER_BURST	2	Number of unique chirps per burst Valid range: 1 to 512 This field Not applicable for loop-back sub-frame
SF3_NUM_LOOPS_PER_BURST	2	Number of times to loop through the unique chirps in each burst, without gaps, using HW. Valid range: 1 to 255
SF3_BURST_PERIOD	4	$PERIOD \geq \text{Sum total time of all bursts} + \text{InterSubFrameBlankTime}$, where, $\text{Sum total time of all bursts} = \text{Num Outer Loops} * \text{Num Bursts} * \text{Burst Period}$. <i>InterSubFrameBlankTime</i> is primarily for sensor calibration/monitoring, thermal control, transferring out any safety monitoring data if requested, hardware reconfiguration for next sub frame, retriggering of next SF. $\text{InterSubFrameBlankTime} \geq 300 \mu\text{s}$ typical, refer a NOTE end of this API for more info. Add $150 \mu\text{s}$ to <i>InterSubFrameBlankTime</i> if data-path re-configuration needed in sub-frame boundary due to change in profile. 1 LSB = 5 ns Valid range $300 \mu\text{s}$ to 1.342 s
SF3_CHIRP_START_INDX_OFFSET	2	The chirp start index for each burst is determined as the chirp start index of the previous burst plus $\text{SF}_x\text{_START_INDX_OFFSET} * \text{BURST_INDX}$ i.e. $\text{CHIRP_START_INDX} = \text{SF}_x\text{_CHIRP_START_INDX} + (\text{SF}_x\text{_CHIRP_START_INDX_OFFSET} * \text{BURST_INDEX})$ Valid range: 0 to 511 A value of 0 can be used to repeat the same set of unique chirps across bursts. Non-zero values allow spanning a larger number of unique chirps (across bursts). This field Not applicable for loop-back sub-frame
SF3_NUM_BURSTS	2	Number of bursts constituting this sub frame Valid range: 1 to 512 Valid range: 1 to 16 for loop-back sub-frame
SF3_NUM_OUTER_LOOPS	2	Number of times to loop over the set of above defined bursts, for this sub frame. Valid range: 1 to 64 This filed is Not applicable for loop-back sub-frame
RESERVED	2	0x0000

Continued on next page

Table 5.29 – continued from previous page

SF3_PERIOD	4	<p>PERIOD \geq Sum total time of all bursts + <i>InterSubFrameBlankTime</i>, where, Sum total time of all bursts = Num Outer Loops * Num Bursts * Burst Period.</p> <p><i>InterSubFrameBlankTime</i> is primarily for sensor calibration/monitoring, thermal control, transferring out any safety monitoring data if requested, hardware reconfiguration for next sub frame, retriggering of next SF.</p> <p><i>InterSubFrameBlankTime</i> \geq 300 μs typical, refer a NOTE end of this API for more info.</p> <p>Add 150 μs to <i>InterSubFrameBlankTime</i> if data-path re-configuration needed in sub-frame boundary due to change in profile.</p> <p>1 LSB = 5 ns Valid range 300 μs to 1.342 s</p>
RESERVED	4	0x00000000
RESERVED	4	0x00000000
SF4_PROFILE_INDXX	2	<p>This is applicable only if FORCE_SINGLE_PROFILE is set to 1. Please refer to that field for description.</p> <p>Valid range: 0 to 3</p>
SF4_CHIRP_START_INDXX	2	<p>Start index of the first chirp in this sub frame</p> <p>Valid range: 0 to 511</p> <p>This field Not applicable for loop-back sub-frame</p>
SF4_NUM_UNIQUE_CHIRPS_PER_BURST	2	<p>Number of unique chirps per burst</p> <p>Valid range: 1 to 512</p> <p>This field Not applicable for loop-back sub-frame</p>
SF4_NUM_LOOPS_PER_BURST	2	<p>Number of times to loop through the unique chirps in each burst, without gaps, using HW.</p> <p>Valid range: 1 to 255</p>
SF4_BURST_PERIOD	4	<p>BURST_PERIOD \geq (NUM_LOOPS_PER_BURST \times (Sum total of all unique chirp times per burst) + <i>InterBurstBlankTime</i>, where <i>InterBurstBlankTime</i> is primarily for sensor calibration / monitoring, thermal control, and some minimum time needed for triggering next burst.</p> <p><i>InterBurstBlankTime</i> \geq 100 μs typical, refer a NOTE end of this API for more info.</p> <p>NOTE: Across bursts, if the value (Sum total of all unique chirp times per burst), is not a constant, then the actual available blank time can vary and needs to be accounted for.</p> <p>1 LSB = 5 ns Valid range: 100 μs to 1.342 s</p>

Continued on next page

Table 5.29 – continued from previous page

SF4_CHIRP_START_INDX_OFFSET	2	<p>The chirp start index for each burst is determined as the chirp start index of the previous burst plus SFx_START_INDX_OFFSET * BURST_INDX i.e.</p> $\text{CHIRP_START_INDX} = \text{SFx_CHIRP_START_INDX} + (\text{SFx_CHIRP_START_INDX_OFFSET} \times \text{BURST_INDEX})$ <p>Valid range: 0 to 511</p> <p>A value of 0 can be used to repeat the same set of unique chirps across bursts. Non-zero values allow spanning a larger number of unique chirps (across bursts). This field Not applicable for loop-back sub-frame</p>
SF4_NUM_BURSTS	2	<p>Number of bursts constituting this sub frame</p> <p>Valid range: 1 to 512</p> <p>Valid range: 1 to 16 for loop-back sub-frame</p>
SF4_NUM_OUTER_LOOPS	2	<p>Number of times to loop over the set of above defined bursts, for this sub frame.</p> <p>Valid range: 1 to 64</p> <p>This field is Not applicable for loop-back sub-frame</p>
RESERVED	2	0x0000
SF4_PERIOD	4	<p>$\text{PERIOD} \geq \text{Sum total time of all bursts} + \text{InterSubFrameBlankTime}$,</p> <p>where, Sum total time of all bursts = Num Outer Loops * Num Bursts * Burst Period.</p> <p><i>InterSubFrameBlankTime</i> is primarily for sensor calibration/monitoring, thermal control, transferring out any safety monitoring data if requested, hardware reconfiguration for next sub frame, retriggering of next SF.</p> <p>$\text{InterSubFrameBlankTime} \geq 300 \mu\text{s}$ typical, refer a NOTE end of this API for more info.</p> <p>Add $150 \mu\text{s}$ to <i>InterSubFrameBlankTime</i> if data-path re-configuration needed in sub-frame boundary due to change in profile.</p> <p>1 LSB = 5 ns</p> <p>Valid range $300 \mu\text{s}$ to 1.342 s</p>
RESERVED	4	0x00000000
RESERVED	4	0x00000000
NUM_FRAMES	2	<p>Number of frames to transmit (1 frame = all enabled sub frames).</p> <p>If set to 0, frames are transmitted endlessly till Frame Stop message is received.</p> <p>Valid range: 0 to 65535</p>

Continued on next page

Table 5.29 – continued from previous page

TRIGGER_SELECT	2	<p>0x0001 SWTRIGGER (Software API based triggering): Frame is triggered upon receiving AWR_FRAMESTARTSTOP_CONF_SB. There could be several tens of micro seconds uncertainty in triggering. This mode is not applicable if this device is configured as MULTICHIP_SLAVE in AWR_CHAN_CONF_SB.</p> <p>0x0002 HWTRIGGER (Hardware SYNC_IN based triggering): Each frame is triggered by rising edge of pulse in SYNC_IN pin, after receiving AWR_FRAMESTARTSTOP_CONF_SB (this is to prevent spurious transmission). w.r.t. the SYNC_IN pulse, the actual transmission has 5ns uncertainty in SINGLECHIP and only a 300 ps uncertainty (due to tight inter-chip synchronization needed) in MULTICHIP sensor applications as defined in AWR_CHAN_CONF_SB.</p>
FRAME_TRIGGER_DELAY	4	<p>Optional time delay from the SYNC_IN trigger to the occurrence of frame chirps. Applicable only in SINGLECHIP sensor applications, as defined in AWR_CHAN_CONF_SB. It is recommended only for staggering the transmission of multiple radar sensors around the car for interference avoidance, if needed.</p> <p>Typical range is 0 to few tens of micro seconds. Units: 1 LSB = 5 ns</p>
RESERVED	4	0x00000000
RESERVED	4	0x00000000

NOTE1:	If hardware trigger mode is used with SUBFRAMETRIGGER = 0, then the trigger should be issued for each burst. If SUBFRAMETRIGGER = 1, then the trigger needs to be issued for each sub-frame.
NOTE2:	If hardware triggered mode is used, the SYNC_IN pulse width should be less than 1 us. Also, the minimum pulse width of SYNC_IN should be 25 ns.
NOTE3:	If frame trigger delay is used with hardware triggered mode, then external SYNC_IN pulse periodicity should take care of the configured frame trigger delay and frame periodicity. The external pulse should be issued only after the sum total of frame trigger delay and frame periodicity. See figure below
NOTE4:	In Hw triggered mode, the Hw pulse should be issued or periodicity of pulse is configured such that, the pulse is generated only 150us after the completion of previous frame/burst (The pulse should not be issued before end of previous frame/burst). The time delta between end of previous frame/burst and raising edge of Hw pulse recommended to be < 300us.
NOTE5:	The PF_NUM_ADC_SAMPLES parameter should be identical across chirps in a sub-frame, when multiple profiles are used in a sub-frame.
NOTE6:	The PF_DIGITAL_OUTPUT_SAMPLING_RATE impacts the LVD-S/CSI2 data rate in a sub-frame, so it is recommended to analyze timing impact if different sample rate is used across chirps in a sub-frame.
NOTE7:	Please refer Table 11.2 and Table 11.3 for details on minimum inter-burst and inter sub-frame/frame blank time requirements.

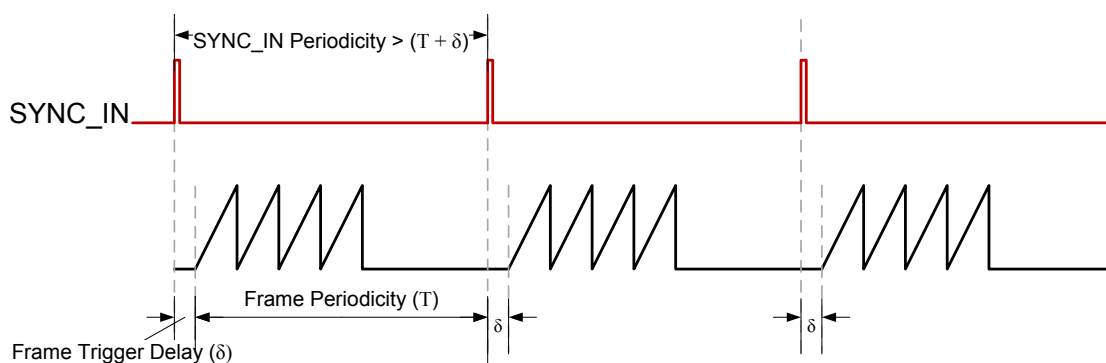

Figure 5.2: Frame trigger delay in case of external hardware trigger

NOTE: The loop-back configuration in this API is not supported in DFP 1.x (1st generation devices). Please refer latest DFP release note for more info.

5.5.7 Sub block 0x0106 – AWR_PERCHIRPPHASESHIFT_CONF_SB

This sub block defines static phase shift configurations per chirp in each of the TXs. The API is applicable only in certain devices (Please refer data sheet). This API will be honored after enabling PERCHIRP_PHASESHIFTER_EN in AWR_RF_RADAR_MISC_CTL_SB.

Table 5.30 describes the contents of this sub block.

Table 5.30: AWR_PERCHIRPPHASESHIFT_CONF_SB contents

Field Name	Number of bytes	Description
SBLKID	2	Value = 0x0106
SBLKLEN	2	Value = 12
CHIRP_START_INDXX	2	Start index of the chirp for configuring the phase shifter Valid range 0 to 511
CHIRP_END_INDXX	2	End index of the chirp for configuring the phase shifter Valid range 0 to 511
TX0_PHASE_SHIFTER	1	TX0 phase shift value Bits TX0 phase shift definition b1:0 RESERVED (set it to 0b00) b7:2 TX0 phase shift value 1 LSB = $360^\circ/2^6 = 5.625^\circ$ Valid range: 0 to 63
TX1_PHASE_SHIFTER	1	TX1 phase shift value Bits TX1 phase shift definition b1:0 RESERVED (set it to 0b00) b7:2 TX1 phase shift value 1 LSB = $360^\circ/2^6 = 5.625^\circ$ Valid range: 0 to 63
TX2_PHASE_SHIFTER	1	TX2 phase shift value Bits TX2 phase shift definition b1:0 RESERVED (set it to 0b00) b7:2 TX2 phase shift value 1 LSB = $360^\circ/2^6 = 5.625^\circ$ Valid range: 0 to 63
RESERVED	1	0x00

NOTE1: Phase shifters are applied at the knee of the ramp.

5.5.8 Sub block 0x0107 – AWR_PROG_FILT_COEFF_RAM_SET_SB

This sub block can be used to program the coefficients for the external programmable filter. The API is applicable only in xWR1642/xWR6843/xWR1843.

Note that the programmable filter is applicable in Complex 1X and Real-only output modes for sampling rates under 6.25 Msps (Complex 1X) and under 12.5 Msps (Real). This is to allow for a trade-off between digital filter chain setting time and close-in anti-alias attenuation. A real-coefficient FIR with up to 26 taps (16-bit coefficients) is supported in the Complex 1X output mode, and a real-coefficient FIR with up to 20 taps (16-bit coefficients) is supported in the Real output mode

NOTE: The programmable filter configuration APIs are not supported in DFP 1.x (1st generation devices). Please refer latest DFP release note for more info.

NOTE: This API should be issued before AWR_PROFILE_CONF_SET_SB.

Table 5.31 describes the contents of this sub block.

Table 5.31: AWR_PROG_FILT_COEFF_RAM_SET_SB contents

Field Name	Number of bytes	Description
SBLKID	2	Value = 0x0107
SBLKLEN	2	Value = 212
COEFF_ARRAY	208	<p>The array of coefficients for the programmable filter, across all profiles, to be stored in the coefficient RAMS. Each tap is a 16-bit signed <1.15, s> number. The exact set of taps to be used for a given profile can be specified through AWR_PROG_FILT_CONF_SB</p> <p>NOTE: All the filter taps across profiles are to be provided in one shot. There is a HW constraint that each profile's filter taps should start at four 32-bit word aligned address (i.e., the coefficients corresponding to any profile should start at array index which is a multiple of 8). Unused coefficients shall be initialized to zero.</p>

5.5.9 Sub block 0x0108 – AWR_PROG_FILT_CONF_SET_SB

This sub block can be used to configure the coefficients for the external programmable filter and associate them to a certain profile. The API is applicable only in xWR1642/xWR6843/xWR1843. This API should be issued before AWR_PROFILE_CONF_SET_SB.

NOTE: The programmable filter configuration APIs are not supported in this release. Please refer latest DFP release note for more info.

Table 5.32 describes the contents of this sub block.

Table 5.32: AWR_PROG_FILT_CONF_SET_SB contents

Field Name	Number of bytes	Description
SBLKID	2	Value = 0x0108
SBLKLEN	2	Value = 8
PROFILE_INDX	1	This field indicates the profile Index for which this configuration applies.
PROG_FILT_COEFF_START_INDEX	1	The index of the first coefficient of the programmable filter taps corresponding to this profile in the coefficient RAM programmed using AWR_PROG_FILT_COEFF_SET_SB NOTE: The profile's filter tap start index shall be 8 tap aligned (four 32-bit word aligned address).
PROG_FILT_LENGTH	1	The length (number of taps) of the filter corresponding to this profile. Together with the previous field, this determines the set of coefficients picked up from the coefficient RAM to form the filter taps for this profile. NOTE: This has to be an even number. For odd-length filters, a 0 (zero) tap needs to be appended at the end to make the length even. This is a HW constraint.
PROG_FILT_FREQ_SHIFT_FACTOR	1	Relevant only for the Complex 1x output mode with the programmable filter. Determines the magnitude of the frequency shift do be done before filtering using the real-coefficient programmable filter. 1 LSB = $0.01 \times F_s$ shift, where F_s is the output sampling rate, specified as PF_DIGITAL_OUTPUT_SAMPLING_RATE in AWR_PROFILE_CONF_SET_SB

NOTE1:	PROG_FILT_COEFF_START_INDEX should be 8 tap aligned (four 32-bit word aligned address)
NOTE2:	Programmable filter APIs (AWR_PROG_FILT_COEFF_RAM_SET_SB and AWR_PROG_FILT_CONF_SET_SB) should not be issued when frames are ongoing.

5.5.10 Sub block 0x0109 – AWR_CALIB_MON_TIME_UNIT_CONF_SB

This API sub block is used to set calibration and monitoring time unit.

Table 5.33: AWR_CALIB_MON_TIME_UNIT_CONF_SB contents

Field Name	Number of bytes	Description
SBLKID	2	Value = 0x0109
SBLKLEN	2	Value = 12
CALIB_MON_TIME_UNIT	2	<p>Defines the basic time unit, in terms of which calibration and/or monitoring periodicities are to be defined.</p> <p>If any monitoring functions are desired and enabled, the monitoring infrastructure automatically inherits this time unit as the period over which the various monitors are cyclically executed; so this should be set to the desired FTTI.</p> <p>For calibrations, a separate CALIB_PERIODICITY can be specified, as a multiple of this time unit, in AWR_RUN_TIME_CALIBRATION_CONF_AND_TRIGGER_SB</p> <p>NOTE: Even though calibrations may not be desired every time unit, every time unit shall be made long enough to include active chirping time, time required for all enabled calibrations and monitoring functions.</p> <p>1 LSB = Duration of one frame Recommendation: See examples in Section 12 Default value: 100 Valid range : 40ms to 250ms (Derive actual count value from programmed frame period)</p>
NUM_OF_CASCADDED_DEV	1	<p>Applicable only in cascaded mode. In non-cascaded mode set this to 1</p> <p>Default value: 1</p>

Continued on next page

Table 5.33 – continued from previous page

DEVICE_ID	1	Applicable only in cascaded mode. In non-cascaded mode set this to 0 Default value: 0
RESERVED	4	0x0000_0000

NOTE1:	The Minimum total blank time in a CAL_MON_TIME_UNIT shall be 1ms to run internal APLL and SYNTH calibrations + ~12.5% of CAL_MON_TIME_UNIT for WDT clearing time if WDT is enabled. Refer to Table 12.3, Table 12.4 for the duration of run time monitors and Table 12.5 for software overheads.
NOTE2:	The CALIB_MON_TIME_UNIT is applicable for one frame trigger API. Once frame is stopped then FTTI will reset, CALIB_MON_TIME_UNIT is not applicable across multiple SW frame trigger API.
NOTE3:	In case of single frame configured in frame config API, then set CALIB_MON_TIME_UNIT to one to run all monitors. It is recommended to use ONE_TIME_CALIB_ENABLE_MASK in AWR_RUN_TIME_CALIBRATION_CONF_AND_TRIGGER_SB API to run one shot calibrations before frame trigger in single frame case.

5.5.11 Sub block 0x010A – AWR_RUN_TIME_CALIBRATION_CONF_AND_TRIGGER_SB

This API is used to trigger one time calibrations instantaneously or schedule periodic run time calibrations, which will be scheduled while framing in inter-burst idle time (Min available idle time of 250 μ s is required).

Table 5.34: AWR_RUN_TIME_CALIBRATION_CONF_AND_TRIGGER_SB contents

Field Name	Number of bytes	Description
SBLKID	2	Value = 0x010A
SBLKLEN	2	Value = 24

Continued on next page

Table 5.34 – continued from previous page

ONE_TIME_ CALIB_ENABLE_ MASK	4	<p>Upon receiving this trigger message, one time calibration of various RF/analog aspects are triggered if the corresponding bits in this field are set to 1. The response is in the form of an asynchronous event sent to the host. The calibrations, if enabled, are performed after the completion of any ongoing calibration cycle, and the calibration results take effect from the frame that begins after the asynchronous event response is sent from the BSS. APLL and SYNTH calibrations are done always internally irrespective of bits are enabled or not, the time required for these calibrations must be allocated.</p> <table border="0"> <thead> <tr> <th>Bit</th> <th>Definition</th> </tr> </thead> <tbody> <tr><td>b0</td><td>RESERVED</td></tr> <tr><td>b1</td><td>RESERVED</td></tr> <tr><td>b2</td><td>RESERVED</td></tr> <tr><td>b3</td><td>RESERVED</td></tr> <tr><td>b4</td><td>LODIST_CALIBRATION_EN</td></tr> <tr><td>b5</td><td>RESERVED</td></tr> <tr><td>b6</td><td>RESERVED</td></tr> <tr><td>b7</td><td>RESERVED</td></tr> <tr><td>b8</td><td>PD_CALIBRATION_EN</td></tr> <tr><td>b9</td><td>TX_POWER_CALIBRATION_EN</td></tr> <tr><td>b10</td><td>RX_GAIN_CALIBRATION_EN</td></tr> <tr><td>b11</td><td>RESERVED</td></tr> <tr><td>b12</td><td>RESERVED</td></tr> <tr><td>b31:13</td><td>RESERVED</td></tr> </tbody> </table> <p>0b0000_0000_0000_0000_000 Default value: 0</p>	Bit	Definition	b0	RESERVED	b1	RESERVED	b2	RESERVED	b3	RESERVED	b4	LODIST_CALIBRATION_EN	b5	RESERVED	b6	RESERVED	b7	RESERVED	b8	PD_CALIBRATION_EN	b9	TX_POWER_CALIBRATION_EN	b10	RX_GAIN_CALIBRATION_EN	b11	RESERVED	b12	RESERVED	b31:13	RESERVED
Bit	Definition																															
b0	RESERVED																															
b1	RESERVED																															
b2	RESERVED																															
b3	RESERVED																															
b4	LODIST_CALIBRATION_EN																															
b5	RESERVED																															
b6	RESERVED																															
b7	RESERVED																															
b8	PD_CALIBRATION_EN																															
b9	TX_POWER_CALIBRATION_EN																															
b10	RX_GAIN_CALIBRATION_EN																															
b11	RESERVED																															
b12	RESERVED																															
b31:13	RESERVED																															

Continued on next page

Table 5.34 – continued from previous page

PERIODIC_ CALIB_ENABLE_ MASK	4	<p>Automatic periodic triggering of calibrations of various RF/analog aspects can be set up by the host issuing this message with corresponding bits in this field set to 1.</p> <table border="0"> <thead> <tr> <th>Bit</th> <th>Definition</th> </tr> </thead> <tbody> <tr><td>b0</td><td>RESERVED</td></tr> <tr><td>b1</td><td>RESERVED</td></tr> <tr><td>b2</td><td>RESERVED</td></tr> <tr><td>b3</td><td>RESERVED</td></tr> <tr><td>b4</td><td>LODIST_CALIBRATION_EN</td></tr> <tr><td>b5</td><td>RESERVED</td></tr> <tr><td>b6</td><td>RESERVED</td></tr> <tr><td>b7</td><td>RESERVED</td></tr> <tr><td>b8</td><td>PD_CALIBRATION_EN</td></tr> <tr><td>b9</td><td>TX_POWER_CALIBRATION_EN</td></tr> <tr><td>b10</td><td>RX_GAIN_CALIBRATION_EN</td></tr> <tr><td>b11</td><td>RESERVED</td></tr> <tr><td>b12</td><td>RESERVED</td></tr> <tr><td>b31:13</td><td>RESERVED</td></tr> </tbody> </table> <p>APLL and SYNTH calibrations are done always internally (at a periodicity of 1 second) irrespective of bits are enabled or not, the time required for these calibrations must be allocated. Refer to Table 12.2 for the duration of run time calibrations</p> <p>Default value: 0</p>	Bit	Definition	b0	RESERVED	b1	RESERVED	b2	RESERVED	b3	RESERVED	b4	LODIST_CALIBRATION_EN	b5	RESERVED	b6	RESERVED	b7	RESERVED	b8	PD_CALIBRATION_EN	b9	TX_POWER_CALIBRATION_EN	b10	RX_GAIN_CALIBRATION_EN	b11	RESERVED	b12	RESERVED	b31:13	RESERVED
Bit	Definition																															
b0	RESERVED																															
b1	RESERVED																															
b2	RESERVED																															
b3	RESERVED																															
b4	LODIST_CALIBRATION_EN																															
b5	RESERVED																															
b6	RESERVED																															
b7	RESERVED																															
b8	PD_CALIBRATION_EN																															
b9	TX_POWER_CALIBRATION_EN																															
b10	RX_GAIN_CALIBRATION_EN																															
b11	RESERVED																															
b12	RESERVED																															
b31:13	RESERVED																															

Continued on next page

Table 5.34 – continued from previous page

CALIBRATION_PERIODICITY	4	<p>This field is applicable only for those calibrations which are enabled to be done periodically in the PERIODIC_CALIB_ENABLE_MASK field. This field indicates the desired periodicity of calibrations.</p> <p>If this field is set to N, the results of the first calibration (based on ONE_TIME_CALIB_ENABLE_MASK) are applicable for the first N CALIB_MON_TIME_UNITS. The results of the next calibration are applicable for the next N CALIB_MON_TIME_UNITS, and so on.</p> <p>Recommendation: Set CALIBRATION_PERIODICITY such that frequency of calibrations is greater than or equal to 1 second.</p> <p>1 LSB = 1 CALIB_MON_TIME_UNIT, as specified in AWR_CALIB_MON_TIME_UNIT_CONF_SB.</p> <p>If the user does not wish to receive calibration reports when periodic calibrations are not enabled, then the user should set CALIBRATION_PERIODICITY to 0 Default value: 0 Valid Range: 0 (Disable), 4 to 100 (value 1 is not a valid value, this will cause internal APLL and SYNTH calibrations to stop)</p>												
ENABLE_CAL_REPORT	1	<table border="0"> <tr> <td style="padding-right: 20px;">Bit</td> <td>Definition</td> </tr> <tr> <td>b0</td> <td>ENABLE_SUMMARY_REPORT</td> </tr> <tr> <td>0</td> <td>Summary reports are disabled</td> </tr> <tr> <td>1</td> <td>Summary reports are enabled</td> </tr> <tr> <td></td> <td>Default value: 0</td> </tr> <tr> <td>b7:1</td> <td>RESERVED</td> </tr> </table> <p>NOTE1: If calibration reports are enabled, the reports will be sent every 1 second whenever internal calibrations (APLL and SYNTH) are triggered and at every CALIBRATION_PERIODICITY when the user enabled calibrations are triggered.</p> <p>NOTE2: If user has not enabled any one time calibrations, but if calibration report is enabled, then after issuing this API, the firmware will attempt to run the APLL and SYNTH calibrations and the calibration report will be immediately sent out.</p>	Bit	Definition	b0	ENABLE_SUMMARY_REPORT	0	Summary reports are disabled	1	Summary reports are enabled		Default value: 0	b7:1	RESERVED
Bit	Definition													
b0	ENABLE_SUMMARY_REPORT													
0	Summary reports are disabled													
1	Summary reports are enabled													
	Default value: 0													
b7:1	RESERVED													
RESERVED	1	0x00												

Continued on next page

Table 5.34 – continued from previous page

TX_POWER_CAL_MODE	1	Bit	Definition
		b0	TX_POWER_CAL_MODE (Not valid for IWR6843 ES1.0) 0 Update TX gain setting from LUT and do a closed loop calibration (OLPC + CLPC) 1 Update TX gain settings from LUT only (OLPC only) OLPC: Open Loop Power Control. In this mode the TX stage codes are set based on a coarse measurement and a LUT generated for every temperature and the stage codes are picked from the LUT CLPC: Closed Loop Power Control. In this mode the TX stage codes are picked from the coarse LUT as generated in OLPC step. Later the TX power is measured and the TX stage codes are corrected to achieve the desired TX power accuracy. Default value: 0
		b7:1	RESERVED
RESERVED	1	0x00	
RESERVED	4	0x00000000	

NOTE1: The API AWR_RUN_TIME_CALIBRATION_CONF_AND_TRIGGER_SB can be issued when the device is framing, the calibration periodicity update or one time calibrations can be done while frames are running.

5.5.12 Sub block 0x010B – AWR_INTER_RX_GAIN_PHASE_CONTROL_SB

This API can be used to induce different gain/phase offsets on the different RXs, for inter-RX mismatch compensation.

NOTE: The Inter RX gain phase control configuration API is not supported in this release. Please refer latest DFP release note for more info.

Table 5.35: AWR_INTER_RX_GAIN_PHASE_CONTROL_SB contents

Field Name	Number of bytes	Description
SBLKID	2	Value = 0x010B
SBLKLEN	2	Value = 28
PROFILE_INDX	1	This field indicates the profile Index for which this configuration applies.
RESERVED	3	0x000000
DIGITAL_GAIN	4	One byte per RX (8-bit signed number) Bits Assignment b7:0 RX0 digital gain b15:8 RX1 digital gain b23:16 RX2 digital gain b31:24 RX3 digital gain 1 LSB = 0.1 dB Valid Range: -120 to 119
DIGITAL_PHASE_SHIFT	8	Two bytes per RX Bits Assignment b15:0 RX0 digital phase shift b31:16 RX1 digital phase shift b47:32 RX2 digital phase shift b63:48 RX3 digital phase shift 1 LSB = $360^\circ / 2^{16} \approx 0.0055^\circ$ Valid Range: 0 to 65535 NOTE: This field is NOT applicable when ADC_OUT_FMT is 00 (real output)
RESERVED	8	0x00000000

5.5.13 Sub block 0x010C – AWR_RX_GAIN_TEMPLUT_SET_SB

This API can be used to overwrite the RX gain temperature LUT used in firmware. This API should be issued after profile configuration API.

Table 5.36: AWR_RX_GAIN_TEMPLUT_SET_SB contents

Field Name	Number of bytes	Description
SBLKID	2	Value = 0x010C
SBLKLEN	2	Value = 28

Continued on next page

Table 5.36 – continued from previous page

PROFILE_INDX	1	This field indicates the profile Index for which this configuration applies.
RESERVED	1	0x00

Continued on next page

Table 5.36 – continued from previous page

RX_GAIN_CODE	19	<p>Byte0: RX gain code for temperature <-30 °C</p> <p>Byte1: RX gain code for temperature [-30, -20) °C</p> <p>Byte2: RX gain code for temperature [-20, -10) °C</p> <p>Byte3: RX gain code for temperature [-10, 0) °C</p> <p>Byte4: RX gain code for temperature [0, 10) °C</p> <p>Byte5: RX gain code for temperature [10, 20) °C</p> <p>Byte6: RX gain code for temperature [20, 30) °C</p> <p>Byte7: RX gain code for temperature [30, 40) °C</p> <p>Byte8: RX gain code for temperature [40, 50) °C</p> <p>Byte9: RX gain code for temperature [50, 60) °C</p> <p>Byte10: RX gain code for temperature [60, 70) °C</p> <p>Byte11: RX gain code for temperature [70, 80) °C</p> <p>Byte12: RX gain code for temperature [80, 90) °C</p> <p>Byte13: RX gain code for temperature [90, 100) °C</p> <p>Byte14: RX gain code for temperature [100, 110) °C</p> <p>Byte15: RX gain code for temperature [110, 120) °C</p> <p>Byte16: RX gain code for temperature [120, 130) °C</p> <p>Byte17: RX gain code for temperature [130, 140) °C</p> <p>Byte18: RX gain code for temperature ≥ 140 °C</p> <p>Each byte is encoded as follows</p> <table border="0"> <tr> <td>Bits</td> <td>Definition</td> </tr> <tr> <td>b4:0</td> <td> IF_GAIN_CODE IF gain is $\text{IF_GAIN_CODE} \times 2 - 6$ dB Valid values: 0 to 17 1 LSB = 2 dB </td> </tr> <tr> <td>b7:5</td> <td> RF_GAIN_CODE xWR1xxx devices: <table border="0"> <tr> <td>Value</td> <td>RF Gain</td> </tr> <tr> <td>0</td> <td>Maximum RF gain</td> </tr> <tr> <td>1</td> <td>Maximum RF gain – 2 dB</td> </tr> <tr> <td>2</td> <td>Maximum RF gain – 4 dB</td> </tr> <tr> <td>3</td> <td>Maximum RF gain – 6 dB</td> </tr> <tr> <td>4</td> <td>Maximum RF gain – 8 dB</td> </tr> </table> xWR6843 device: <table border="0"> <tr> <td>Value</td> <td>RF Gain</td> </tr> <tr> <td>0</td> <td>Maximum RF gain</td> </tr> <tr> <td>1</td> <td>Maximum RF gain – 3.5 dB</td> </tr> <tr> <td>2</td> <td>Maximum RF gain – 6 dB</td> </tr> </table> </td> </tr> </table>	Bits	Definition	b4:0	IF_GAIN_CODE IF gain is $\text{IF_GAIN_CODE} \times 2 - 6$ dB Valid values: 0 to 17 1 LSB = 2 dB	b7:5	RF_GAIN_CODE xWR1xxx devices: <table border="0"> <tr> <td>Value</td> <td>RF Gain</td> </tr> <tr> <td>0</td> <td>Maximum RF gain</td> </tr> <tr> <td>1</td> <td>Maximum RF gain – 2 dB</td> </tr> <tr> <td>2</td> <td>Maximum RF gain – 4 dB</td> </tr> <tr> <td>3</td> <td>Maximum RF gain – 6 dB</td> </tr> <tr> <td>4</td> <td>Maximum RF gain – 8 dB</td> </tr> </table> xWR6843 device: <table border="0"> <tr> <td>Value</td> <td>RF Gain</td> </tr> <tr> <td>0</td> <td>Maximum RF gain</td> </tr> <tr> <td>1</td> <td>Maximum RF gain – 3.5 dB</td> </tr> <tr> <td>2</td> <td>Maximum RF gain – 6 dB</td> </tr> </table>	Value	RF Gain	0	Maximum RF gain	1	Maximum RF gain – 2 dB	2	Maximum RF gain – 4 dB	3	Maximum RF gain – 6 dB	4	Maximum RF gain – 8 dB	Value	RF Gain	0	Maximum RF gain	1	Maximum RF gain – 3.5 dB	2	Maximum RF gain – 6 dB
Bits	Definition																											
b4:0	IF_GAIN_CODE IF gain is $\text{IF_GAIN_CODE} \times 2 - 6$ dB Valid values: 0 to 17 1 LSB = 2 dB																											
b7:5	RF_GAIN_CODE xWR1xxx devices: <table border="0"> <tr> <td>Value</td> <td>RF Gain</td> </tr> <tr> <td>0</td> <td>Maximum RF gain</td> </tr> <tr> <td>1</td> <td>Maximum RF gain – 2 dB</td> </tr> <tr> <td>2</td> <td>Maximum RF gain – 4 dB</td> </tr> <tr> <td>3</td> <td>Maximum RF gain – 6 dB</td> </tr> <tr> <td>4</td> <td>Maximum RF gain – 8 dB</td> </tr> </table> xWR6843 device: <table border="0"> <tr> <td>Value</td> <td>RF Gain</td> </tr> <tr> <td>0</td> <td>Maximum RF gain</td> </tr> <tr> <td>1</td> <td>Maximum RF gain – 3.5 dB</td> </tr> <tr> <td>2</td> <td>Maximum RF gain – 6 dB</td> </tr> </table>	Value	RF Gain	0	Maximum RF gain	1	Maximum RF gain – 2 dB	2	Maximum RF gain – 4 dB	3	Maximum RF gain – 6 dB	4	Maximum RF gain – 8 dB	Value	RF Gain	0	Maximum RF gain	1	Maximum RF gain – 3.5 dB	2	Maximum RF gain – 6 dB							
Value	RF Gain																											
0	Maximum RF gain																											
1	Maximum RF gain – 2 dB																											
2	Maximum RF gain – 4 dB																											
3	Maximum RF gain – 6 dB																											
4	Maximum RF gain – 8 dB																											
Value	RF Gain																											
0	Maximum RF gain																											
1	Maximum RF gain – 3.5 dB																											
2	Maximum RF gain – 6 dB																											

Continued on next page

Table 5.36 – continued from previous page

RESERVED	1	0x00
RESERVED	2	0x0000

5.5.14 Sub block 0x010D – AWR_TX_GAIN_TEMPLUT_SET_SB

This API can be used to overwrite the TX gain temperature LUT used in firmware. This API should be issued after profile configuration API.

Table 5.37: AWR_TX_GAIN_TEMPLUT_SET_SB contents

Field Name	Number of bytes	Description
SBLKID	2	Value = 0x010D
SBLKLEN	2	Value = 68
PROFILE_INDX	1	This field indicates the profile Index for which this configuration applies
RESERVED	1	0x00

Continued on next page

Table 5.37 – continued from previous page

TX0_GAIN_CODE	19	Byte0: TX0 gain code for temperature <-30 °C Byte1: TX0 gain code for temperature [-30, -20) °C Byte2: TX0 gain code for temperature [-20, -10) °C Byte3: TX0 gain code for temperature [-10, 0) °C Byte4: TX0 gain code for temperature [0, 10) °C Byte5: TX0 gain code for temperature [10, 20) °C Byte6: TX0 gain code for temperature [20, 30) °C Byte7: TX0 gain code for temperature [30, 40) °C Byte8: TX0 gain code for temperature [40, 50) °C Byte9: TX0 gain code for temperature [50, 60) °C Byte10: TX0 gain code for temperature [60, 70) °C Byte11: TX0 gain code for temperature [70, 80) °C Byte12: TX0 gain code for temperature [80, 90) °C Byte13: TX0 gain code for temperature [90, 100) °C Byte14: TX0 gain code for temperature [100, 110) °C Byte15: TX0 gain code for temperature [110, 120) °C Byte16: TX0 gain code for temperature [120, 130) °C Byte17: TX0 gain code for temperature [130, 140) °C Byte18: TX0 gain code for temperature ≥140 °C Each byte is encoded as follows <table border="0" data-bbox="673 1146 1093 1294"> <tr> <td>Bits</td> <td>Definition</td> </tr> <tr> <td>b5:0</td> <td>STG_CODE Higher values for higher gain</td> </tr> <tr> <td>b7:6</td> <td>RESERVED</td> </tr> </table>	Bits	Definition	b5:0	STG_CODE Higher values for higher gain	b7:6	RESERVED
Bits	Definition							
b5:0	STG_CODE Higher values for higher gain							
b7:6	RESERVED							
RESERVED	1	0x00						

Continued on next page

Table 5.37 – continued from previous page

TX1_GAIN_CODE	19	Byte0: TX1 gain code for temperature <-30 °C Byte1: TX1 gain code for temperature [-30, -20) °C Byte2: TX1 gain code for temperature [-20, -10) °C Byte3: TX1 gain code for temperature [-10, 0) °C Byte4: TX1 gain code for temperature [0, 10) °C Byte5: TX1 gain code for temperature [10, 20) °C Byte6: TX1 gain code for temperature [20, 30) °C Byte7: TX1 gain code for temperature [30, 40) °C Byte8: TX1 gain code for temperature [40, 50) °C Byte9: TX1 gain code for temperature [50, 60) °C Byte10: TX1 gain code for temperature [60, 70) °C Byte11: TX1 gain code for temperature [70, 80) °C Byte12: TX1 gain code for temperature [80, 90) °C Byte13: TX1 gain code for temperature [90, 100) °C Byte14: TX1 gain code for temperature [100, 110) °C Byte15: TX1 gain code for temperature [110, 120) °C Byte16: TX1 gain code for temperature [120, 130) °C Byte17: TX1 gain code for temperature [130, 140) °C Byte18: TX1 gain code for temperature ≥140 °C Each byte is encoded as follows Bits Definition b5:0 STG_CODE Higher values for higher gain b7:6 RESERVED
RESERVED	1	0x00

Continued on next page

Table 5.37 – continued from previous page

TX2_GAIN_CODE	19	Byte0: TX2 gain code for temperature <-30 °C Byte1: TX2 gain code for temperature [-30, -20) °C Byte2: TX2 gain code for temperature [-20, -10) °C Byte3: TX2 gain code for temperature [-10, 0) °C Byte4: TX2 gain code for temperature [0, 10) °C Byte5: TX2 gain code for temperature [10, 20) °C Byte6: TX2 gain code for temperature [20, 30) °C Byte7: TX2 gain code for temperature [30, 40) °C Byte8: TX2 gain code for temperature [40, 50) °C Byte9: TX2 gain code for temperature [50, 60) °C Byte10: TX2 gain code for temperature [60, 70) °C Byte11: TX2 gain code for temperature [70, 80) °C Byte12: TX2 gain code for temperature [80, 90) °C Byte13: TX2 gain code for temperature [90, 100) °C Byte14: TX2 gain code for temperature [100, 110) °C Byte15: TX2 gain code for temperature [110, 120) °C Byte16: TX2 gain code for temperature [120, 130) °C Byte17: TX2 gain code for temperature [130, 140) °C Byte18: TX2 gain code for temperature ≥140 °C Each byte is encoded as follows <table border="0"> <tr> <td>Bits</td> <td>Definition</td> </tr> <tr> <td>b5:0</td> <td>STG_CODE Higher values for higher gain</td> </tr> <tr> <td>b7:6</td> <td>RESERVED</td> </tr> </table>	Bits	Definition	b5:0	STG_CODE Higher values for higher gain	b7:6	RESERVED
Bits	Definition							
b5:0	STG_CODE Higher values for higher gain							
b7:6	RESERVED							
RESERVED	1	0x00						
RESERVED	2	0x0000						

5.5.15 Sub block 0x010E – AWR_LOOPBACK_BURST_CONF_SET_SB

This API can be used to introduce loopback chirps within the functional frames. This loopback chirps will be introduced only if advanced frame configuration is used where user can define which sub-frame contains loopback chirps. The following loopback configuration will apply to one burst and user can program up to 16 different loopback configurations in 16 different bursts of a given sub-frame. User has to ensure that the corresponding sub-frame is defined in AWR_ADVANCED_FRAME_CONF_SB and sufficient time is given to allow the loopback bursts to be transmitted.

NOTE: The loop-back configuration API is not supported in this release. Please refer latest DFP release note for more info.

NOTE1:	If user desires to enable loopback chirps within functional frames, then this API should be issued after AWR_PROFILE_CONF_SET_SB
NOTE2:	Only profile based phase shifter is supported in loopback configuration. Per-chirp phase shifter if enabled will not be reflected in loopback chirps.
NOTE3:	For the sub-frame in which loopback is desired, user should set SFx_NUM_UNIQUE_CHIRPS_PER_BURST as 1 and can use SFx_NUM_LOOPS_PER_BURST for multiple chirps in the burst.

Table 5.38: AWR_LOOPBACK_BURST_CONF_SET_SB contents

Field Name	Number of bytes	Description												
SBLKID	2	Value = 0x010E												
SBLKLEN	2	Value = 48												
LOOPBACK_SEL	1	<table border="0"> <tr> <td>Value</td> <td>Definition</td> </tr> <tr> <td>0</td> <td>No loopback</td> </tr> <tr> <td>1</td> <td>IF loopback</td> </tr> <tr> <td>2</td> <td>PS loopback</td> </tr> <tr> <td>3</td> <td>PA loopback</td> </tr> <tr> <td>Others</td> <td>RESERVED</td> </tr> </table>	Value	Definition	0	No loopback	1	IF loopback	2	PS loopback	3	PA loopback	Others	RESERVED
Value	Definition													
0	No loopback													
1	IF loopback													
2	PS loopback													
3	PA loopback													
Others	RESERVED													
BASE_PROFILE_INDX	1	Base profile used for loopback chirps Valid values 0 to 3												
BURST_INDX	1	Indicates the index of the burst in the loopback sub-frame for which this configuration applies Valid values 0 to 15												
RESERVED	1	0x00												
FREQ_CONST	4	Start frequency for loopback. The start frequency configured here should be within profile's sweep bandwidth. For 77GHz Devices (76GHz to 81GHz): 1 LSB = $3.6e9/2^{26}$ Hz \approx 53.644 Hz Valid range: 0x5471C71B to 0x5A000000 For 60GHz Devices (57GHz to 64GHz): 1 LSB = $2.7e9/2^{26}$ Hz \approx 40.233 Hz Valid range: 0x5471C71C to 0x5ED097B4												

Continued on next page

Table 5.38 – continued from previous page

SLOPE_CONST	2	<p>Frequency slope for loopback burst (32 bit signed number)</p> <p>For 77GHz Devices (76GHz to 81GHz): 1 LSB = $3.6e9 \times 900/2^{26} \approx 48.279 \text{ kHz}/\mu\text{s}$ Valid range: -2072 to 2072</p> <p>For 60GHz Devices (57GHz to 64GHz): 1 LSB = $2.7e9 \times 900/2^{26} \approx 36.21 \text{ kHz}/\mu\text{s}$ Valid range: Only even numbers between -6905 and 6905</p>																												
RESERVED	2	0x0000																												
TX_BACKOFF	4	<table border="0"> <thead> <tr> <th>Bits</th> <th>Definition</th> </tr> </thead> <tbody> <tr> <td>b7:0</td> <td>TX0 back off 1 LSB = 1 dB</td> </tr> <tr> <td>b15:8</td> <td>TX1 back off 1 LSB = 1 dB</td> </tr> <tr> <td>b23:16</td> <td>TX2 back off 1 LSB = 1 dB</td> </tr> <tr> <td>b31:24</td> <td>RESERVED</td> </tr> </tbody> </table> <p>This setting is applicable only in PA loop-back mode.</p>	Bits	Definition	b7:0	TX0 back off 1 LSB = 1 dB	b15:8	TX1 back off 1 LSB = 1 dB	b23:16	TX2 back off 1 LSB = 1 dB	b31:24	RESERVED																		
Bits	Definition																													
b7:0	TX0 back off 1 LSB = 1 dB																													
b15:8	TX1 back off 1 LSB = 1 dB																													
b23:16	TX2 back off 1 LSB = 1 dB																													
b31:24	RESERVED																													
RX_GAIN	2	<table border="0"> <thead> <tr> <th>Bits</th> <th>Definition</th> </tr> </thead> <tbody> <tr> <td>b5:0</td> <td> RX_GAIN This field defines RX gain for each profile 1 LSB = 1 dB Valid values: all even values from 24 to 52 </td> </tr> <tr> <td>b7:6</td> <td> RF_GAIN_TARGET AWR12xx, AWR14xx, AWR16xx, AWR18xx: <table border="0"> <tr><td>Value</td><td>RF gain target</td></tr> <tr><td>00</td><td>30 dB</td></tr> <tr><td>01</td><td>34 dB</td></tr> <tr><td>10</td><td>RESERVED</td></tr> <tr><td>11</td><td>26 dB</td></tr> </table> xWR6843 ES2: <table border="0"> <tr><td>Value</td><td>RF gain target</td></tr> <tr><td>00</td><td>30 dB</td></tr> <tr><td>01</td><td>33 dB</td></tr> <tr><td>10</td><td>36 dB</td></tr> <tr><td>11</td><td>RESERVED</td></tr> </table> </td> </tr> <tr> <td>b15:8</td> <td>RESERVED</td> </tr> </tbody> </table>	Bits	Definition	b5:0	RX_GAIN This field defines RX gain for each profile 1 LSB = 1 dB Valid values: all even values from 24 to 52	b7:6	RF_GAIN_TARGET AWR12xx, AWR14xx, AWR16xx, AWR18xx: <table border="0"> <tr><td>Value</td><td>RF gain target</td></tr> <tr><td>00</td><td>30 dB</td></tr> <tr><td>01</td><td>34 dB</td></tr> <tr><td>10</td><td>RESERVED</td></tr> <tr><td>11</td><td>26 dB</td></tr> </table> xWR6843 ES2: <table border="0"> <tr><td>Value</td><td>RF gain target</td></tr> <tr><td>00</td><td>30 dB</td></tr> <tr><td>01</td><td>33 dB</td></tr> <tr><td>10</td><td>36 dB</td></tr> <tr><td>11</td><td>RESERVED</td></tr> </table>	Value	RF gain target	00	30 dB	01	34 dB	10	RESERVED	11	26 dB	Value	RF gain target	00	30 dB	01	33 dB	10	36 dB	11	RESERVED	b15:8	RESERVED
Bits	Definition																													
b5:0	RX_GAIN This field defines RX gain for each profile 1 LSB = 1 dB Valid values: all even values from 24 to 52																													
b7:6	RF_GAIN_TARGET AWR12xx, AWR14xx, AWR16xx, AWR18xx: <table border="0"> <tr><td>Value</td><td>RF gain target</td></tr> <tr><td>00</td><td>30 dB</td></tr> <tr><td>01</td><td>34 dB</td></tr> <tr><td>10</td><td>RESERVED</td></tr> <tr><td>11</td><td>26 dB</td></tr> </table> xWR6843 ES2: <table border="0"> <tr><td>Value</td><td>RF gain target</td></tr> <tr><td>00</td><td>30 dB</td></tr> <tr><td>01</td><td>33 dB</td></tr> <tr><td>10</td><td>36 dB</td></tr> <tr><td>11</td><td>RESERVED</td></tr> </table>	Value	RF gain target	00	30 dB	01	34 dB	10	RESERVED	11	26 dB	Value	RF gain target	00	30 dB	01	33 dB	10	36 dB	11	RESERVED									
Value	RF gain target																													
00	30 dB																													
01	34 dB																													
10	RESERVED																													
11	26 dB																													
Value	RF gain target																													
00	30 dB																													
01	33 dB																													
10	36 dB																													
11	RESERVED																													
b15:8	RESERVED																													

Continued on next page

Table 5.38 – continued from previous page

TX_ENABLE	1	Bits	Definition
		b0	TX0 Enable
		b1	TX1 Enable
		b2	TX2 Enable (PS LB not supported for TX2)
		b7:3	RESERVED
		This setting is applicable in all loop-back modes.	
RESERVED	1	0x00	
BPM_CONFIG	2	Bit	Definition
		b0	CONST_BPM_VAL_TX0_OFF Value of Binary Phase Shift value for TX0, during idle time
		b1	CONST_BPM_VAL_TX0_ON Value of Binary Phase Shift value for TX0, during chirp
		b2	CONST_BPM_VAL_TX1_OFF For TX1
		b3	CONST_BPM_VAL_TX1_ON For TX1
		b4	CONST_BPM_VAL_TX2_OFF For TX2
		b5	CONST_BPM_VAL_TX2_ON For TX2
		b15:6	RESERVED
		This setting is applicable only in PA and PS loop-back modes.	
DIGITAL_CORRECTION_DISABLE	2	Bits	Digital corrections
		b0	IQMM correction disable (only for PS and PA loopback, for IF loopback IQMM is disabled by firmware) 0 - Enable, 1 - Disable
		b1	Inter-RX Gain and Phase correction disable 0 - Enable, 1 - Disable This setting is applicable in all loop-back modes.
		b15:2	RESERVED

Continued on next page

Table 5.38 – continued from previous page

IF_LOOPBACK_FREQ	1	Value	IF Loopback frequency	Value	IF Loopback frequency
		0	180 kHz	8	4.02 MHz
		1	240 kHz	9	5 MHz
		2	360 kHz	10	6 MHz
		3	720 kHz	11	8.03 MHz
		4	1 MHz	12	9 MHz
		5	2 MHz	13	10 MHz
		6	2.5 MHz	255-14	RESERVED
		7	3 MHz		
IF_LOOPBACK_MAG	1	1 LSB = 10 mV Valid range: 1 to 63			
PS1_PGA_GAIN_INDEX	1	PGA gain for TX0			
		Value	PGA gain value	Value	PGA gain value
		0	PGA is OFF	15	-3 dB
		1	-22 dB	16	-2 dB
		2	-16 dB	17	-1 dB
		3	-15 dB	18	0 dB
		4	-14 dB	19	1 dB
		5	-13 dB	20	2 dB
		6	-12 dB	21	3 dB
		7	-11 dB	22	4 dB
		8	-10 dB	23	5 dB
		9	-9 dB	24	6 dB
		10	-8 dB	25	7 dB
		11	-7 dB	26	8 dB
		12	-6 dB	27	9 dB
13	-5 dB	255-28	RESERVED		
14	-4 dB				

Continued on next page

Table 5.38 – continued from previous page

PS2_PGA_GAIN_INDEX	1	PGA gain for TX1			
		Value	PGA gain value	Value	PGA gain value
		0	PGA is OFF	15	-3 dB
		1	-22 dB	16	-2 dB
		2	-16 dB	17	-1 dB
		3	-15 dB	18	0 dB
		4	-14 dB	19	1 dB
		5	-13 dB	20	2 dB
		6	-12 dB	21	3 dB
		7	-11 dB	22	4 dB
		8	-10 dB	23	5 dB
		9	-9 dB	24	6 dB
		10	-8 dB	25	7 dB
		11	-7 dB	26	8 dB
		12	-6 dB	27	9 dB
13	-5 dB	255-28	RESERVED		
14	-4 dB				
PS_LOOPBACK_FREQ	4	Phase shifter loop back frequency in kHz 1 LSB = 1 kHz Bits Definition b15:0 TX0 Loopback Frequency [b31:16] TX1 Loopback Frequency			
RESERVED	4	RESERVED			
PA_LOOPBACK_FREQ	2	This value is a 100 MHz divider which sets the loopback frequency For e.g. for a 1 MHz frequency, set this to 100 For a 2 MHz frequency, set this to 50 NOTE: To ensure no leakage of signal power, user has to ensure that 100MHz/LOOPBACK_FREQ is an integer multiple of bin width For e.g. if user choses 25Msps sampling rate and 2048 samples/chirp, then LOOPBACK_FREQ of 64 (=1.5625 MHz) will ensure no leakage			
RESERVED	2	0x0000			
RESERVED	2	0x0000			
RESERVED	2	0x0000			

5.5.16 Sub block 0x010F – AWR_DYN_CHIRP_CONF_SET_SB

This API can be used to dynamically change the chirp configuration while frames are on-going. The configuration will be stored in software and the new configuration will be applied after receiving the AWR_DYN_CHIRP_ENABLE_SB API.

Table 5.39: AWR_DYN_CHIRP_CONF_SET_SB contents

Field Name	Number of bytes	Description												
SBLKID	2	Value = 0x010F												
SBLKLEN	2	Value = 200												
CHIRP_ROW_SELECT	1	Bits Description b3:0 RESERVED b7:4 If user does not wish to reconfigure all 3 chirp rows, then the following mode can be used to configure only one row per chirp which enables the user to configure 48 chirps in one API, effectively saving on the reconfiguration time. If CHIRP_ROW_SELECT[7:4] is non-zero, then the API parameters CHIRP _x _R1, CHIRP _x _R2 and CHIRP _x _R3 for $1 \leq x \leq 16$ in this API would mean CHIRP(3x - 2) _{Ry} , CHIRP(3x - 1) _{Ry} and CHIRP(3x) _{Ry} where <i>y</i> is as per the below table <table border="1"> <thead> <tr> <th>Value</th> <th>Definition</th> </tr> </thead> <tbody> <tr> <td>0b0000</td> <td>Enables all 3 chirp rows to be reconfigured (default)</td> </tr> <tr> <td>0b0001</td> <td>Enables only chirp row 1 to be reconfigured</td> </tr> <tr> <td>0b0010</td> <td>Enables only chirp row 2 to be reconfigured</td> </tr> <tr> <td>0b0011</td> <td>Enables only chirp row 3 to be reconfigured</td> </tr> <tr> <td>Others</td> <td>RESERVED</td> </tr> </tbody> </table>	Value	Definition	0b0000	Enables all 3 chirp rows to be reconfigured (default)	0b0001	Enables only chirp row 1 to be reconfigured	0b0010	Enables only chirp row 2 to be reconfigured	0b0011	Enables only chirp row 3 to be reconfigured	Others	RESERVED
Value	Definition													
0b0000	Enables all 3 chirp rows to be reconfigured (default)													
0b0001	Enables only chirp row 1 to be reconfigured													
0b0010	Enables only chirp row 2 to be reconfigured													
0b0011	Enables only chirp row 3 to be reconfigured													
Others	RESERVED													
CHIRP_SEGMENT_SELECT	1	Valid range 0 to 31. Indicates the segment of the chirp RAM that the 16 chirp definitions in this sub block map to												

Continued on next page

Table 5.39 – continued from previous page

PROGRAM_ MODE	2	Bits	Description
		b0	Value Definition
		0	Program the new configuration when AWR_DYN_CHIRP_ENABLE API is issued
		1	Program the new configuration immediately NOTE: User has to ensure that the chirps which are being reconfigured are not the ones which are currently in use for chirping
		b15:1	RESERVED

Continued on next page

Table 5.39 – continued from previous page

CHIRP1_R1	4	Bits	Definition
		b3:0	PROFILE_INDX Valid range 0 to 3
		b7:4	RESERVED
		b13:8	FREQ_SLOPE_VAR For 77GHz Devices (76GHz to 81GHz): 1 LSB = $3.6e9 \times 900/2^{26} \approx 48.279$ kHz Valid range: 0 to 63 For 60GHz Devices (57GHz to 64GHz): 1 LSB = $2.7e9 \times 900/2^{26} \approx 36.21$ kHz Valid range: Only even numbers from 0 to 63
		b15:14	RESERVED
		b18:16	TX_ENABLE
			Bit Definition
			b0 TX0 Enable
			b1 TX1 Enable
			b2 TX2 Enable
		b23:19	RESERVED
		b29:24	BPM_CONSTANT_BITS
			Bit Definition
			b0 CONST_BPM_VAL_TX0_OFF Value of Binary Phase Shift value for TX0, during idle time
			b1 CONST_BPM_VAL_TX0_ON Value of Binary Phase Shift value for TX0, during chirp
			b2 CONST_BPM_VAL_TX1_OFF For TX1
			b3 CONST_BPM_VAL_TX1_ON For TX1
	b4 CONST_BPM_VAL_TX2_OFF For TX2		
	b5 CONST_BPM_VAL_TX2_ON For TX2		
b31:30	RESERVED		

Continued on next page

Table 5.39 – continued from previous page

CHIRP1_R2	4	Bits	Definition
		b22:0	FREQ_START_VAR For 77GHz Devices (76GHz to 81GHz): 1 LSB = $3.6e9/2^{26} \approx 53.644$ Hz Valid range: 0 to 8388607 For 60GHz Devices (57GHz to 64GHz): 1 LSB = $2.7e9/2^{26} \approx 40.233$ Hz Valid range: 0 to 8388607
		b31:23	RESERVED
CHIRP1_R3	4	Bits	Definition
		b11:0	IDLE_TIME_VAR 1 LSB = 10 ns Valid range: 0 to 4095
		b15:12	RESERVED
		b27:16	ADC_START_TIME_VAR 1 LSB = 10 ns Valid range: 0 to 4095
		b31:28	RESERVED
CHIRP2_R1	4	See description for CHIRP1_R1	
CHIRP2_R2	4	See description for CHIRP1_R2	
CHIRP2_R3	4	See description for CHIRP1_R3	
...	
CHIRP16_R1	4	See description for CHIRP1_R1	
CHIRP16_R2	4	See description for CHIRP1_R2	
CHIRP16_R3	4	See description for CHIRP1_R3	

NOTE: If user wants to update the chirp ram rows using dynamic chirp config API in runtime then it is must to use same dynamic chirp config API (instead of legacy chirp config API) to configure all chirp parameters during sensor initialization.

5.5.17 Sub block 0x0110 – AWR_DYN_PERCHIRP_PHASESHIFTER_CONF_SET_SB

This API can be used to dynamically change the per-chirp phase shifter configuration (applicable only in certain devices) while frames are on-going. The configuration will be stored in software and the new configuration will be applied after receiving the AWR_DYN_CHIRP_ENABLE_SB API.

Table 5.40: AWR_DYN_PERCHIRP_PHASESHIFTER_CONF_SB contents

Field Name	Number of bytes	Description
SBLKID	2	Value = 0x0110
SBLKLEN	2	Value = 56
RESERVED	1	0x00
CHIRP_SEGMENT_SELECT	1	Indicates the segment of the chirp RAM that the 16 chirp definitions in this sub block map to. Valid range 0 to 31
CHIRP1_TX0_PHASE_SHIFTER	1	TX0 phase shift value Bits TX0 phase shift definition b1:0 RESERVED (set it to 0b00) b7:2 TX0 phase shift value 1 LSB = $360^\circ/2^6 = 5.625^\circ$ Valid range: 0 to 63
CHIRP1_TX1_PHASE_SHIFTER	1	TX1 phase shift value Bits TX1 phase shift definition b1:0 RESERVED (set it to 0b00) b7:2 TX1 phase shift value 1 LSB = $360^\circ/2^6 = 5.625^\circ$ Valid range: 0 to 63
CHIRP1_TX2_PHASE_SHIFTER	1	TX2 phase shift value Bits TX1 phase shift definition b1:0 RESERVED (set it to 0b00) b7:2 TX1 phase shift value 1 LSB = $360^\circ/2^6 = 5.625^\circ$ Valid range: 0 to 63
CHIRP2_TX0_PHASE_SHIFTER	1	See description for CHIRP1_TX0_PHASE_SHIFTER
CHIRP2_TX1_PHASE_SHIFTER	1	See description for CHIRP2_TX1_PHASE_SHIFTER
CHIRP2_TX2_PHASE_SHIFTER	1	See description for CHIRP3_TX2_PHASE_SHIFTER
...
CHIRP16_TX0_PHASE_SHIFTER	1	See description for CHIRP1_TX0_PHASE_SHIFTER

Continued on next page

Table 5.40 – continued from previous page

CHIRP16_ TX1_PHASE_ SHIFTER	1	See description for CHIRP2_TX1_PHASE_SHIFTER	
CHIRP16_ TX2_PHASE_ SHIFTER	1	See description for CHIRP3_TX2_PHASE_SHIFTER	
PROGRAM_ MODE	2	Bits	Description
		b0	Value Definition
			0 Program the new configuration when AWR_DYN_CHIRP_ENABLE API is issued
			1 Program the new configuration immediately
			NOTE: User has to ensure that the chirps which are being reconfigured are not the ones which are currently in use for chirping
		b15:1	RESERVED

5.5.18 Sub block 0x0111 – AWR_DYN_CHIRP_ENABLE_SB

This API can be used to trigger the copy of chirp configuration from software to hardware. The copy will be performed at the end of the ongoing frame active window (start of the frame idle time).

Table 5.41: AWR_DYN_CHIRP_ENABLE_SB contents

Field Name	Number of bytes	Description
SBLKID	2	Value = 0x0111
SBLKLEN	2	Value = 8
RESERVED	4	0x00000000

NOTE: HW reconfiguration time (as shown in the figure below) is around 500 μ s. User has to ensure that AWR_DYN_CHIRP_ENABLE_SB API is issued at least 500 μ s before the end of the ongoing frame active window (start of the frame idle time) to apply configurations for next frame onwards.

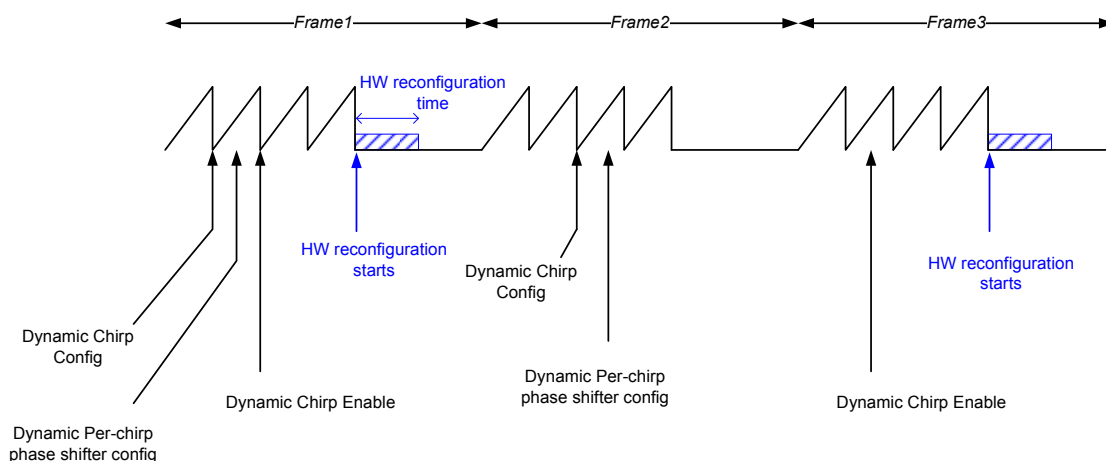

Figure 5.3: Dynamic chirp configuration use case timing diagram

5.5.19 Sub block 0x0112 – AWR_INTERCHIRP_BLOCKCONTROLS_SB

This API can be used to program the inter-chirp turn on and turn off times or various RF blocks.

NOTE: The inter-chirp timing control configuration API is supported in this release. Please refer latest DFP release note for more info.

Table 5.42: AWR_INTERCHIRP_BLOCKCONTROLS_SB contents

Field Name	Number of bytes	Description
SBLKID	2	Value = 0x0112
SBLKLEN	2	Value = 44
RX02_RF_TURN_OFF_TIME	2	Time to wait after ramp end before turning off RX0 and RX2 RF stages. 1 LSB = 10 ns Valid range: -1024 to 1023
RX13_RF_TURN_OFF_TIME	2	Time to wait after ramp end before turning off RX1 and RX3 RF stages. 1 LSB = 10 ns Valid range: -1024 to 1023
RX02_BB_TURN_OFF_TIME	2	Time to wait after ramp end before turning off RX0 and RX2 baseband stages. 1 LSB = 10 ns Valid range: -1024 to 1023

Continued on next page

Table 5.42 – continued from previous page

RX13_BB_TURN_OFF_TIME	2	Time to wait after ramp end before turning off RX1 and RX3 baseband stages. 1 LSB = 10 ns Valid range: -1024 to 1023
RX02_RF_PRE_ENABLE_TIME	2	Time before TX Start Time when RX0 and RX2 RF stages are to be put in fast-charge state. 1 LSB = 10 ns Valid range: -1024 to 1023
RX13_RF_PRE_ENABLE_TIME	2	Time before TX Start Time when RX1 and RX3 RF stages are to be put in fast-charge state. 1 LSB = 10 ns Valid range: -1024 to 1023
RX02_BB_PRE_ENABLE_TIME	2	Time before TX Start Time when RX1 and RX3 baseband stages are to be put in fast-charge state. 1 LSB = 10 ns Valid range: -1024 to 1023
RX13_BB_PRE_ENABLE_TIME	2	Time before TX Start Time when RX2 and RX4 baseband stages are to be put in fast-charge state. 1 LSB = 10 ns Valid range: -1024 to 1023
RX02_RF_TURN_ON_TIME	2	Time before TX Start Time when RX1 and RX3 RF stages are to be enabled. 1 LSB = 10 ns Valid range: -1024 to 1023
RX13_RF_TURN_ON_TIME	2	Time before TX Start Time when RX2 and RX4 RF stages are to be enabled. 1 LSB = 10 ns Valid range: -1024 to 1023
RX02_BB_TURN_ON_TIME	2	Time before TX Start Time when RX1 and RX3 baseband stages are to be enabled. 1 LSB = 10 ns Valid range: -1024 to 1023
RX13_BB_TURN_ON_TIME	2	Time before TX Start Time when RX2 and RX4 baseband stages are to be enabled. 1 LSB = 10 ns Valid range: -1024 to 1023
RX_LO_CHAIN_TURN_OFF_TIME	2	Time to wait after ramp end before turning off RX LO chain. 1 LSB = 10 ns Valid range: -1024 to 1023
TX_LO_CHAIN_TURN_OFF_TIME	2	Time to wait after ramp end before turning off TX LO chain. 1 LSB = 10 ns Valid range: -1024 to 1023

Continued on next page

Table 5.42 – continued from previous page

RX_LO_CHAIN_TURN_ON_TIME	2	Time before TX Start Time when the RX LO chain is to be enabled. 1 LSB = 10 ns Valid range: -1024 to 1023
TX_LO_CHAIN_TURN_ON_TIME	2	Time before TX Start Time when the TX LO chain is to be enabled. 1 LSB = 10 ns Valid range: -1024 to 1023
RESERVED	4	0x00000000
RESERVED	4	0x00000000

NOTE:

The minimum inter-chirp time should be greater than maximum of the following

1. $\text{abs}(\text{RX02_RF_TURN_OFF_TIME}) + \max(\text{abs}(\text{RX02_RF_PRE_ENABLE_TIME}), \text{abs}(\text{RX02_RF_TURN_ON_TIME}))$
2. $\text{abs}(\text{RX13_RF_TURN_OFF_TIME}) + \max(\text{abs}(\text{RX13_RF_PRE_ENABLE_TIME}), \text{abs}(\text{RX13_RF_TURN_ON_TIME}))$
3. $\text{abs}(\text{RX02_BB_TURN_OFF_TIME}) + \max(\text{abs}(\text{RX02_BB_PRE_ENABLE_TIME}), \text{abs}(\text{RX02_BB_TURN_ON_TIME}))$
4. $\text{abs}(\text{RX13_BB_TURN_OFF_TIME}) + \max(\text{abs}(\text{RX13_BB_PRE_ENABLE_TIME}), \text{abs}(\text{RX13_BB_TURN_ON_TIME}))$
5. $\text{abs}(\text{RX_LO_TURN_OFF_TIME}) + \text{abs}(\text{RX_LO_TURN_ON_TIME})$
6. $\text{abs}(\text{TX_LO_TURN_OFF_TIME}) + \text{abs}(\text{TX_LO_TURN_ON_TIME})$

5.5.20 Sub block 0x0113 – AWR_SUBFRAME_START_CONF_SB

This API can be used to trigger each sub-frame individually in software triggered mode. This API takes effect only when the advanced frame configuration indicates that each sub-frame needs to be individually triggered by the user.

Table 5.43: AWR_SUBFRAME_START_CONF_SB contents

Field Name	Number of bytes	Description								
SBLKID	2	Value = 0x0113								
SBLKLEN	2	Value = 8								
START_CMD	2	<table border="0"> <tr> <td>Bits</td> <td>Definition</td> </tr> <tr> <td>b15:0</td> <td>Value Definition</td> </tr> <tr> <td></td> <td>0x0000 No effect</td> </tr> <tr> <td></td> <td>0x0001 Trigger next sub-frame in software triggered sub-frame mode</td> </tr> </table>	Bits	Definition	b15:0	Value Definition		0x0000 No effect		0x0001 Trigger next sub-frame in software triggered sub-frame mode
Bits	Definition									
b15:0	Value Definition									
	0x0000 No effect									
	0x0001 Trigger next sub-frame in software triggered sub-frame mode									
RESERVED	2	0x0000								

NOTE1: If the user wishes to trigger each sub-frame independently, then after advanced frame config, the FRAME START command should be issued once using AWR_FRAMESTARTSTOP_CONF_SB. This does not start any sub-frames but it will prepare the hardware for sub-frame trigger. Next any subsequent sub-frame trigger will start the sub-frames

NOTE2: If the user wishes to use sub-frame trigger, he has to ensure that sub-frame trigger command is issued $k \cdot N$ times where k is the number of sub-frames in each frame and N is the number of frames. If the user wishes to stop frames in between, then he has to issue the FRAME STOP command (using AWR_FRAMESTARTSTOP_CONF_SB) only after $k \cdot M$ triggers of sub-frame trigger command (where M is an integer). i.e. FRAME STOP command can be issued only at frame boundaries

NOTE3: If software based sub-frame trigger mode is chosen by the user, watchdog feature will not be available. User has to ensure that the watchdog is disabled before enabling the software based sub-frame trigger mode.

NOTE4: If sub-frame trigger or hardware trigger mode is used to trigger the frames/sub-frames and if frames need to be stopped before the specified number of frames, then the the FRAME_STOP command using [AWR_FRAMESTARTSTOP_CONF_SB](#) API should be issued while the frame is on-going. If the frames are stopped while the device is idle, it can lead to errors.

NOTE5: This API is not supported in IWR6843 ES1.0

5.6 Sub blocks related to AWR_RF_DYNAMIC_CONF_GET_SB

5.6.1 Sub block 0x0120 – AWR_PROFILE_CONF_GET_SB

This sub block reads the parameters of a given profile. The profile details are available as part of the acknowledgment. The structure is same as AWR_PROFILE_CONF_SET_SB

Table 5.44 describes the contents of this sub block.

Table 5.44: AWR_PROFILE_CONF_GET_SB contents

Field Name	Number of bytes	Description
SBLKID	2	Value = 0x0120
SBLKLEN	2	Value = 8
PROFILE_INDX	2	Valid range 0 to 3 Index of the profile which is to be read
RESERVED	2	0x0000

5.6.2 Sub block 0x0121 – AWR_CHIRP_CONF_GET_SB

This sub block reads the parameters of a given chirp. The profile details are available as part of the acknowledgement. The structure is same as AWR_CHIRP_CONF_SET_SB

Table 5.45 describes the contents of this sub block.

Table 5.45: AWR_CHIRP_CONF_GET_SB contents

Field Name	Number of bytes	Description
SBLKID	2	Value = 0x0121
SBLKLEN	2	Value = 8
CHIRP_START_INDX	2	Valid range 0 to 511 Starting index of the chirp which is to be read
CHIRP_END_INDX	2	Valid range 0 to 511 Ending index of the chirp which is to be read

5.6.3 Sub block 0x0122 – AWR_FRAME_CONF_GET_SB

This sub block reads the parameters of the configured frame. The profile details are available as part of the acknowledgement. The structure is same as AWR_FRAME_CONF_SET_SB

Table 5.46 describes the contents of this sub block.

Table 5.46: AWR_FRAME_CONF_GET_SB contents

Field Name	Number of bytes	Description
SBLKID	2	Value = 0x0122
SBLKLEN	2	Value = 4

5.6.4 Sub block 0x0123 – RESERVED

5.6.5 Sub block 0x0124 – RESERVED

5.6.6 Sub block 0x0125 – AWR_ADV_FRAME_CONF_GET_SB

This sub block reads the parameters of the configured frame. The profile details are available as part of the acknowledgement. The structure is same as AWR_ADVANCED_FRAME_CONF_SET_SB

Table 5.47 describes the contents of this sub block.

Table 5.47: AWR_ADV_FRAME_CONF_GET_SB contents

Field Name	Number of bytes	Description
SBLKID	2	Value = 0x0125
SBLKLEN	2	Value = 4

5.6.7 Sub block 0x0126 – RESERVED

5.6.8 Sub block 0x0127 – RESERVED

5.6.9 Sub block 0x0128 – RESERVED

5.6.10 Sub block 0x0129 – RESERVED

5.6.11 Sub block 0x012A – RESERVED

5.6.12 Sub block 0x012B – RESERVED

5.6.13 Sub block 0x012C – AWR_RX_GAIN_TEMPLUT_GET_SB

This API is issued to read the temperature based RX gain LUT used by the firmware. This API should be issued after the profile configuration API. The acknowledgement packet sent in response to this API will contain the LUT. The structure is same as AWR_RX_GAIN_LUT_SET_SB.

Table 5.48: AWR_RX_GAIN_TEMPLUT_GET_SB contents

Field Name	Number of bytes	Description
SBLKID	2	Value = 0x012C
SBLKLEN	2	Value = 8
PROFILE_INDX	1	Profile index for which the RX gain LUT is desired
RESERVED	3	0x000000

5.6.14 Sub block 0x012D – AWR_TX_GAIN_TEMPLUT_GET_SB

This API is issued to read the temperature based TX gain LUT used by the firmware. This API should be issued after the profile configuration API. The acknowledgement packet sent in response to this API will contain the LUT. The structure is same as AWR_TX_GAIN_LUT_SET_SB.

Table 5.49: AWR_TX_GAIN_TEMPLUT_GET_SB contents

Field Name	Number of bytes	Description
SBLKID	2	Value = 0x012D
SBLKLEN	2	Value = 8
PROFILE_INDX	1	Profile index for which the TX gain LUT is desired
RESERVED	3	0x000000

NOTE: This API is not supported in IWR6843 ES1.0

5.7 Sub blocks related to AWR_FRAME_TRIG_MSG

5.7.1 Sub block 0x0140 – AWR_FRAMESTARTSTOP_CONF_SB

This sub block starts or stops transmission of frames.

Table 5.50 describes the contents of this sub block.

Table 5.50: AWR_FRAMESTARTSTOP_CONF_SB contents

Field Name	Number of bytes	Description
SBLKID	2	Value = 0x0140

Continued on next page

Table 5.50 – continued from previous page

SBLKLEN	2	Value = 8						
START_STOP_CMD	2	<table border="1"> <thead> <tr> <th>Value</th> <th>Definition</th> </tr> </thead> <tbody> <tr> <td>0x0000</td> <td>Stop the transmission of frames after the current frame is over at frame boundary</td> </tr> <tr> <td>0x0001</td> <td>Trigger a frame in software triggered mode. In hardware SYNC_IN triggered mode, this command allows subsequent SYNC_IN trigger to be honored</td> </tr> </tbody> </table>	Value	Definition	0x0000	Stop the transmission of frames after the current frame is over at frame boundary	0x0001	Trigger a frame in software triggered mode. In hardware SYNC_IN triggered mode, this command allows subsequent SYNC_IN trigger to be honored
Value	Definition							
0x0000	Stop the transmission of frames after the current frame is over at frame boundary							
0x0001	Trigger a frame in software triggered mode. In hardware SYNC_IN triggered mode, this command allows subsequent SYNC_IN trigger to be honored							
RESERVED	2	0x0000						

NOTE: When Frame Stop command is sent to RadarSS, the frame will be stopped after completing all the chirps of a Frame/Advance frame. In non periodic Hw triggered mode if frame stop command is issued when Hw pulses are paused (i.e after completing previous frame) then a Hw pulse is required to trigger next frame/bursts and frame will be stopped at the end of this triggered frame. In Hw triggered mode, the forced frame stop is not supported, the frame end command is honored only if frames are actively running.

5.8 Sub blocks related to AWR_RF_ADVANCED_FEATURES_CONF_SET_MSG

5.8.1 Sub block 0x0180 – AWR_BPM_COMMON_CONF_SET_SB

This API sub block defines static configurations related to BPM (Binary Phase Modulation) feature in each of the TXs. E.g. the source of the BPM pattern (one constant value for each chirp as defined, or intra-chirp pseudo random BPM pattern as found by a programmable LFSR or a programmable sequence inside each chirp), are defined here.

Table 5.51 describes the contents of this sub block.

Table 5.51: AWR_BPM_COMMON_CONF_SET_SB contents

Field Name	Number of bytes	Description
SBLKID	2	Value = 0x0180
SBLKLEN	2	Value = 20

Continued on next page

Table 5.51 – continued from previous page

BPM_MODE_CFG	2	Bits	Description
		b1:0	BPM_SRC_SEL (select source of BPM pattern)
		Value	Definition
		00	CHIRP_CONFIG_BPM (refer to AWR_BPM_CHIRP_CONF_SB)
		01	RESERVED
		10	RESERVED
		11	RESERVED
		b15:2	RESERVED
RESERVED	2	0x0000	
RESERVED	2	0x0000	
RESERVED	2	0x0000	
RESERVED	4	0x00000000	
RESERVED	4	0x00000000	

5.8.2 Sub block 0x0181 – AWR_BPM_CHIRP_CONF_SET_SB

This sub block defines static configurations related to BPM (Binary Phase Modulation) feature in each of the TXs.

Table 5.52 describes the contents of this sub block.

Table 5.52: AWR_BPM_CHIRP_CONF_SET_SB contents

Field Name	Number of bytes	Description
SBLKID	2	Value = 0x0181
SBLKLEN	2	Value = 12
CHIRP_START_INDXX	2	Start index of the chirp for configuring the constant BPM Valid range 0 to 511
CHIRP_END_INDXX	2	End index of the chirp for configuring the constant BPM Valid range 0 to 511

Continued on next page

Table 5.52 – continued from previous page

CONST_BPM_VAL	2	Bit	Definition
		b0	CONST_BPM_VAL_TX0_TXOFF Value of Binary Phase Shift value for TX0, when during idle time
		b1	CONST_BPM_VAL_TX0_TXON Value of Binary Phase Shift value for TX0, during chirp
		b2	CONST_BPM_VAL_TX1_TXOFF Value of Binary Phase Shift value for TX1, when during idle time
		b3	CONST_BPM_VAL_TX1_TXON Value of Binary Phase Shift value for TX1, during chirp
		b4	CONST_BPM_VAL_TX2_TXOFF Value of Binary Phase Shift value for TX2, when during idle time
		b5	CONST_BPM_VAL_TX2_TXON Value of Binary Phase Shift value for TX2, during chirp
		b15:6	RESERVED
RESERVED	2	0x0000	

NOTE1:	BPM values are applied at TX_START_TIME.
NOTE2:	In xWR1843 device, If only BPM is used without phase shifter then recommended to disable the boot time phase shifter calibration in RF init.
NOTE2:	In xWR1843 device, If both phase shifter and BPM is used then recommended to achieve BPM logic using per chirp phase shifter API instead of using BPM API

5.8.3 Sub block 0x0182 – AWR_POWER_SAVE_MODE_CONF_SET_SB

This sub block defines the power saving modes and API configuration
 Table 5.53 describes the contents of this sub block.

Table 5.53: AWR_POWER_SAVE_MODE_CONF_SET_SB contents

Field Name	Number of bytes	Description
SBLKID	2	Value = 0x0182

Continued on next page

Table 5.53 – continued from previous page

SBLKLEN	2	Value = 24
PWR_SAVE_MODE	2	<p>Power saving modes are defined as below</p> <p>Mode Definition</p> <p>0 No change in device PWR_SAVE_MODE, device will remain stay in current power save state.</p> <p>1 RF_POWER_DOWN, device enters RF power down mode from normal active mode (mode 2).</p> <p>2 RF_POWER_UP, device enters RF power up mode from RF power down mode (mode 1).</p> <p>3 APLL_POWER_DOWN, device enters APLL power down mode from RF power down mode (mode 1). Application has to ensure, the device MSS, BSS and DSS clock system is switched to XTAL clock before powering down APLL.</p> <p>4 APLL_POWER_UP, device enters APLL power up mode from APLL power down mode (mode 3). Application has to ensure, the device MSS, BSS and DSS clock system is switched back to APLL clock after powering up APLL.</p> <p>5 - RESERVED</p> <p>65535</p>
RESERVED	2	RESERVED
RESERVED	16	RESERVED

NOTE: This API is not applicable for any device in this release.

5.9 Sub blocks related to AWR_RF_STATUS_GET_MSG

5.9.1 Sub block 0x0220 – AWR_RF_VERSION_GET_SB

This sub block reads RF HW and FW versions. The information returned by the device will be in the format as given in AWR_RFVERSION_SB.

Table 5.54 describes the contents of the request sub block

Table 5.54: AWR_RF_VERSION_GET_SB contents

Field Name	Number of bytes	Description
SBLKID	2	Value = 0x0220
SBLKLEN	2	Value = 4

Response to AWR_RFVERSION_GET_SB

AWR_RFVERSION_SB sub block is sent by the radar device in response to AWR_RFVERSION_GET_SB. Note that SBLKID for both AWR_RFVERSION_GET_SB and AWR_RFVERSION_SB are same.

Table 5.55 describes the contents of the response sub block.

Table 5.55: AWR_RF_VERSION_SB response contents

Field Name	Number of bytes	Description
SBLKID	2	Value = 0x0220
SBLKLEN	2	Value = 20
HW_VARIANT	1	HW variant number
HW_VERSION_MAJOR	1	HW version major number
HW_VERSION_MINOR	1	HW version minor number
BSS_FW_VERSION_MAJOR	1	BSS FW version major number
BSS_FW_VERSION_MINOR	1	BSS FW version minor number
BSS_FW_VERSION_BUILD	1	BSS FW version build number
BSS_FW_VERSION_DEBUG	1	BSS FW version debug number
BSS_FW_VERSION_YEAR	1	Year of BSS FW version release
BSS_FW_VERSION_MONTH	1	Month of BSS FW version release
BSS_FW_VERSION_DAY	1	Day of BSS FW version release
BSS_FW_VERSION_PATCH_MAJOR	1	BSS FW version patch major number
BSS_FW_VERSION_PATCH_MINOR	1	BSS FW version patch minor number
BSS_FW_VERSION_PATCH_YEAR	1	Year of BSS FW patch release

Continued on next page

Table 5.55 – continued from previous page

BSS_FW_VERSION_PATCH_MONTH	1	Month of BSS FW patch release						
BSS_FW_VERSION_PATCH_DAY	1	Day of BSS FW patch release						
BSS_FW_PATCH_BUILD_DEBUG_VERSION	1	<table border="0"> <tr> <td>Bit</td> <td>Definition</td> </tr> <tr> <td>b3:0</td> <td>DEBUG version number</td> </tr> <tr> <td>b7:4</td> <td>BUILD version number</td> </tr> </table>	Bit	Definition	b3:0	DEBUG version number	b7:4	BUILD version number
Bit	Definition							
b3:0	DEBUG version number							
b7:4	BUILD version number							

5.9.2 Sub block 0x0221 – AWR_RF_CPUFAULT_STATUS_GET_SB

This sub block provides the RF BSS CPU fault information.

Table 5.56 describes the content of this sub block.

Table 5.56: AWR_RF_CPUFAULT_STATUS_GET_SB response contents

Field Name	Number of bytes	Description
SBLKID	2	Value = 0x0221
SBLKLEN	2	Value = 4

AWR_RF_CPUFAULT_STATUS_SB is sent in response to AWR_RF_CPUFAULT_STATUS_GET_SB.

Table 5.57 describes the content of AWR_RF_CPUFAULT_STATUS_SB

Table 5.57: AWR_RF_CPUFAULT_STATUS_GET_SB response contents

Field Name	Number of bytes	Description
SBLKID	2	Value = 0x0221
SBLKLEN	2	Value = 36

Continued on next page

Table 5.57 – continued from previous page

FAULT_TYPE	1	Value	Definition
		0	RF Processor Undefined Instruction Abort
		1	RF Processor Instruction pre-fetch Abort
		2	RF Processor Data Access Abort
		3	RF Processor Firmware Fatal Error
		0x4 - 0xFE	RESERVED
		0xFF	No fault
RESERVED	1	0x00	
LINE_NUM	2	Valid only in case of FAULT type is 0x3, provides the firmware line number at which fatal error occurred.	
FAULT_LR	4	The instruction PC address at which Fault occurred	
FAULT_PREV_LR	4	The return address of the function from which fault function has been called (Call stack LR)	
FAULT_SPSR	4	The CPSR register value at which fault occurred	
FAULT_SP	4	The SP register value at which fault occurred	
FAULT_CAUSE_ADDRESS	4	The address access at which Fault occurred (valid only for fault type 0x0 to 0x2)	
FAULT_ERROR_STATUS	2	The status of Error (Error Cause type – valid only for fault type 0x0 to 0x2)	
		0x000	BACKGROUND_ERR
		0x001	ALIGNMENT_ERR
		0x002	DEBUG_EVENT
		0x00D	PERMISSION_ERR
		0x008	SYNCH_EXTER_ERR
		0x406	ASYNCH_EXTER_ERR
		0x409	SYNCH_ECC_ERR
		0x408	ASYNCH_ECC_ERR
FAULT_ERROR_SOURCE	1	The Source of the Error (Error Source type - valid only for fault type 0x0 to 0x2)	
		0x0	ERR_SOURCE_AXI_MASTER
		0x1	ERR_SOURCE_ATCM
		0x2	ERR_SOURCE_BTCM
FAULT_AXI_ERROR_TYPE	1	The AXI Error type (Error Source type - valid only for fault type 0x0 to 0x2)	
		0x0	AXI_DECOD_ERR
		0x1	AXI_SLAVE_ERR

Continued on next page

Table 5.57 – continued from previous page

FAULT_ACCESS_TYPE	1	The Error Access type (Error Access type - valid only for fault type 0x0 to 0x2) 0x0 READ_ERR 0x1 WRITE_ERR
FAULT_RECOVERY_TYPE	1	The Error Recovery type (Error Recovery type - Valid only for fault type 0x0 to 0x2) 0x0 UNRECOVERY 0x1 RECOVERY
RESERVED	2	0x0000

5.9.3 Sub block 0x0222 – AWR_RF_ESMFAULT_STATUS_GET_SB

This sub block provides the information regarding additional RF sub system faults. Table 5.58 describes the content of this sub block.

Table 5.58: AWR_RF_ESMFAULT_STATUS_GET_SB response contents

Field Name	Number of bytes	Description
SBLKID	2	Value = 0x0222
SBLKLEN	2	Value = 4

The response to above request is given in the AWR_RF_ESMFAULT_STATUS_SB. Table 5.59 describes the contents of AWR_RF_ESMFAULT_STATUS_SB.

Table 5.59: AWR_RF_ESMFAULT_STATUS_SB response contents

Field Name	Number of bytes	Description
SBLKID	2	Value = 0x0222
SBLKLEN	2	Value = 12

Continued on next page

Table 5.59 – continued from previous page

ESM_GROUP1_ ERRORS	4	Bit	Error Information
		b0	RAMPGEN_SB_ERROR
		b1	RESERVED
		b2	GPADC_RAM_SB_ERROR
		b3	VIM_RAM_SB_ERROR
		b4	DFE_SELFTEST_ERROR
		b5	VIM_SELFTEST_ERROR
		b6	B0TCM_SB_ERROR
		b7	B1TCM_SB_ERROR
		b8	CCMR4_SELFTEST_ERROR
		b9	ATCM_SB_ERROR
		b10	RAMPGEN_SELFTEST_ERROR
		b11	RAMPGEN_PAR_SELFTEST_ERROR
		b12	SEQ_EXT_SELFTEST_ERROR
		b13	SEQ_EXT_SB_ERROR
		b14	RESERVED
		b15	AGC_RAM_SB_ERROR
		b16	B1TCM_PAR_CHK_ERROR
		b17	B0TCM_PAR_CHK_ERROR
		b18	ATCM_PAR_CHK_ERROR
		b19	MB_MSS2BSS_SB_ERROR
		b20	MB_BSS2MSS_SB_ERROR
b31:21	RESERVED		

Continued on next page

Table 5.59 – continued from previous page

ESM_GROUP2_ ERRORS	4	Bit	Error Information
		b0	DFE_STC_ERROR
		b1	CR4_STC_ERROR
		b2	CCMR4_COMP_ERROR
		b3	B0TCM_DB_ERROR
		b4	B1TCM_DB_ERROR
		b5	ATCM_DB_ERROR
		b6	DCC_ERROR
		b7	SEQ_EXT_ERROR
		b8	SYNT_FREQ_MON_ERROR
		b9	DFE_PARITY_ERROR
		b10	RAMPGEN_DB_ERROR
		b11	BUBBLE_CORRECTION_FAIL
		b12	RAMPGEN_LOCSTEP_ERROR
		b13	RTI_RESET_ERROR
		b14	GPADC_RAM_DB_ERROR
		b15	VIM_COMP_ERROR
		b16	CR4_LIVE_LOCK_ERROR
		b17	WDT_NMI_ERROR
		b18	VIM_RAM_DB_ERROR
		b19	RAMPGEN_PAR_ERROR
		b20	SEQ_EXT_DB_ERROR
		b21	DMA_MPU_ERROR
		b22	AGC_RAM_DB_ERROR
		b23	CRC_COMP_ERROR
		b24	WAKEUP_STS_ERROR
		b25	SHORT_CIRCUIT_ERROR
		b26	B1TCM_PAR_ERROR
		b27	B0TCM_PAR_ERROR
		b28	ATCM_PAR_ERROR
		b29	MB_MSS2BSS_DB_ERROR
		b30	MB_BSS2MSS_DB_ERROR
b31	CCC_ERROR		

5.9.4 Sub block 0x0223 – AWR_RF_DIEID_GET_SB

This sub block provides the information regarding the Die ID of the device.

Table 5.60: AWR_RF_DIEID_GET_SB response contents

Field Name	Number of bytes	Description
SBLKID	2	Value = 0x0223
SBLKLEN	2	Value = 4

The response to above request is given in the AWR_RF_DIEID_STATUS_SB. Table 5.61 describes the contents of AWR_RF_DIEID_STATUS_SB.

Table 5.61: AWR_RF_DIEID_STATUS_SB response contents

Field Name	Number of bytes	Description
SBLKID	2	Value = 0x0223
SBLKLEN	2	Value = 36
LOT_NO	4	Lot number
WAFER_NO	4	Wafer number
DEV_X	4	X cordinate of the die in the wafer
DEV_Y	4	Y cordinate of the die in the wafer
RESERVED	4	0x00000000
RESERVED	4	0x00000000
RESERVED	4	0x00000000
RESERVED	4	0x00000000

5.9.5 Sub block 0x0224 – AWR_RF_BOOTUPBIST_STATUS_GET_SB

This sub block provides the information regarding boot up self-test status. Table 5.62 describes the content of this sub block.

Table 5.62: AWR_RF_BOOTUPBIST_STATUS_GET_SB response contents

Field Name	Number of bytes	Description
SBLKID	2	Value = 0x0224
SBLKLEN	2	Value = 4

The response of this sub block will be AWR_RF_BOOTUPBIST_STATUS_DATA_SB with content

as shown in Table 5.63

Table 5.63: AWR_RF_BOOTUPBIST_STATUS_DATA_SB response contents

Field Name	Number of bytes	Description
SBLKID	2	Value = 0x0224
SBLKLEN	2	Value = 20
RF_POWERUP_BIST_STATUS_FLAGS	4	1 - PASS, 0 - FAIL Bit Status Information b0 ROM CRC check b1 CR4 and VIM lockstep test b2 RESERVED b3 VIM test (Not supported in 1st Gen devices, refer latest release note) b4 STC test of diagnostic b5 CR4 STC b6 CRC test b7 RAMPGEN memory ECC test b8 DFE Parity test b9 DFE memory ECC b10 RAMPGEN lockstep test b11 FRC lockstep test b12 DFE memory PBIST b13 RAMPGEN memory PBIST b14 PBIST test b15 WDT test b16 ESM test b17 DFE STC b18 RESERVED b19 ATCM, BTCM ECC test b20 ATCM, BTCM parity test b21 RESERVED b22 RESERVED b23 RESERVED b24 FFT test b25 RTI test b26 PCR test b31:27 RESERVED

Continued on next page

Table 5.63 – continued from previous page

POWERUP_ TIME	4	RF BIST SS power up time 1 LSB = 5 ns
RESERVED	4	0x00000000
RESERVED	4	0x00000000

NOTE: Bootup digital monitoring status are not applicable for QM devices

5.10 Sub blocks related to AWR_RF_MONITORING_REPORT_GET_MSG

5.10.1 Sub block 0x0260 – AWR_RF_DFE_STATISTICS_REPORT_GET_SB

NOTE: The DFE statistics GET API is not supported in this release. Please refer latest DFP release note for more info.

Table 5.64 describes the content of this sub block.

Table 5.64: AWR_RF_DFE_STATISTICS_REPORT_GET_SB response contents

Field Name	Number of bytes	Description
SBLKID	2	Value = 0x0260
SBLKLEN	2	Value = 4

The response of this sub block will be AWR_RF_DFE_STATISTICS_REPORT_SB with content as shown in Table 5.65

Table 5.65: AWR_RF_DFE_STATISTICS_REPORT_SB response contents

Field Name	Number of bytes	Description
SBLKID	2	Value = 0x0260
SBLKLEN	2	Value = 196
PF0_RX0_ICH	2	Residual DC value in I chain for profile 0, RX channel 0 (post DC and IQ mismatch correction) represented by a 16 bit signed number 1 LSB = $1V/2^{15}$ referred to ADC input

Continued on next page

Table 5.65 – continued from previous page

PF0_RX0_QCH	2	Residual DC value in Q chain for profile 0, RX channel 0 (post DC and IQ mismatch correction) represented by a 16 bit signed number 1 LSB = $1V/2^{15}$ referred to ADC input
PF0_RX0_ISQ	2	RMS power in I chain for profile 0, RX channel 0 (post DC and IQ mismatch correction) represented by a 16 bit unsigned number 1 LSB = $1V^2/2^{15}$ referred to ADC input
PF0_RX0_QSQ	2	RMS power in Q chain for profile 0, RX channel 0 (post DC and IQ mismatch correction) represented by a 16 bit unsigned number 1 LSB = $1V^2/2^{15}$ referred to ADC input
PF0_RX0_IQ-CORR	4	Cross correlation between I and Q chains for profile 0, RX channel 0 (post DC and IQ mismatch correction) represented by a 32 bit signed number 1 LSB = $1V^2/2^{30}$ referred to ADC input
PF0_RX1_ICH	2	Residual DC value in I chain for profile 0, RX channel 1 (post DC and IQ mismatch correction) represented by a 16 bit signed number 1 LSB = $1V/2^{15}$ referred to ADC input
PF0_RX1_QCH	2	Residual DC value in Q chain for profile 0, RX channel 1 (post DC and IQ mismatch correction) represented by a 16 bit signed number 1 LSB = $1V/2^{15}$ referred to ADC input
PF0_RX1_ISQ	2	RMS power in I chain for profile 0, RX channel 1 (post DC and IQ mismatch correction) represented by a 16 bit unsigned number 1 LSB = $1V^2/2^{15}$ referred to ADC input
PF0_RX1_QSQ	2	RMS power in Q chain for profile 0, RX channel 1 (post DC and IQ mismatch correction) represented by a 16 bit unsigned number 1 LSB = $1V^2/2^{15}$ referred to ADC input
PF0_RX1_IQ-CORR	4	Cross correlation between I and Q chains for profile 0, RX channel 1 (post DC and IQ mismatch correction) represented by a 32 bit signed number 1 LSB = $1V^2/2^{30}$ referred to ADC input
PF0_RX2_ICH	2	Residual DC value in I chain for profile 0, RX channel 2 (post DC and IQ mismatch correction) represented by a 16 bit signed number 1 LSB = $1V/2^{15}$ referred to ADC input

Continued on next page

Table 5.65 – continued from previous page

PF0_RX2_QCH	2	Residual DC value in Q chain for profile 0, RX channel 2 (post DC and IQ mismatch correction) represented by a 16 bit signed number 1 LSB = $1V/2^{15}$ referred to ADC input
PF0_RX2_ISQ	2	RMS power in I chain for profile 0, RX channel 2 (post DC and IQ mismatch correction) represented by a 16 bit unsigned number 1 LSB = $1V^2/2^{15}$ referred to ADC input
PF0_RX2_QSQ	2	RMS power in Q chain for profile 0, RX channel 2 (post DC and IQ mismatch correction) represented by a 16 bit unsigned number 1 LSB = $1V^2/2^{15}$ referred to ADC input
PF0_RX2_IQ-CORR	4	Cross correlation between I and Q chains for profile 0, RX channel 2 (post DC and IQ mismatch correction) represented by a 32 bit signed number 1 LSB = $1V^2/2^{30}$ referred to ADC input
PF0_RX3_ICH	2	Residual DC value in I chain for profile 0, RX channel 3 (post DC and IQ mismatch correction) represented by a 16 bit signed number 1 LSB = $1V/2^{15}$ referred to ADC input
PF0_RX3_QCH	2	Residual DC value in Q chain for profile 0, RX channel 3 (post DC and IQ mismatch correction) represented by a 16 bit signed number 1 LSB = $1V/2^{15}$ referred to ADC input
PF0_RX3_ISQ	2	RMS power in I chain for profile 0, RX channel 3 (post DC and IQ mismatch correction) represented by a 16 bit unsigned number 1 LSB = $1V^2/2^{15}$ referred to ADC input
PF0_RX3_QSQ	2	RMS power in Q chain for profile 0, RX channel 3 (post DC and IQ mismatch correction) represented by a 16 bit unsigned number 1 LSB = $1V^2/2^{15}$ referred to ADC input
PF0_RX3_IQ-CORR	4	Cross correlation between I and Q chains for profile 0, RX channel 3 (post DC and IQ mismatch correction) represented by a 32 bit signed number 1 LSB = $1V^2/2^{30}$ referred to ADC input
PF1_RX0_ICH	2	Residual DC value in I chain for profile 1, RX channel 0 (post DC and IQ mismatch correction) represented by a 16 bit signed number 1 LSB = $1V/2^{15}$ referred to ADC input

Continued on next page

Table 5.65 – continued from previous page

PF1_RX0_QCH	2	Residual DC value in Q chain for profile 1, RX channel 0 (post DC and IQ mismatch correction) represented by a 16 bit signed number 1 LSB = $1V/2^{15}$ referred to ADC input
PF1_RX0_ISQ	2	RMS power in I chain for profile 1, RX channel 0 (post DC and IQ mismatch correction) represented by a 16 bit unsigned number 1 LSB = $1V^2/2^{15}$ referred to ADC input
PF1_RX0_QSQ	2	RMS power in Q chain for profile 1, RX channel 0 (post DC and IQ mismatch correction) represented by a 16 bit unsigned number 1 LSB = $1V^2/2^{15}$ referred to ADC input
PF1_RX0_IQ-CORR	4	Cross correlation between I and Q chains for profile 1, RX channel 0 (post DC and IQ mismatch correction) represented by a 32 bit signed number 1 LSB = $1V^2/2^{30}$ referred to ADC input
PF1_RX1_ICH	2	Residual DC value in I chain for profile 1, RX channel 1 (post DC and IQ mismatch correction) represented by a 16 bit signed number 1 LSB = $1V/2^{15}$ referred to ADC input
PF1_RX1_QCH	2	Residual DC value in Q chain for profile 1, RX channel 1 (post DC and IQ mismatch correction) represented by a 16 bit signed number 1 LSB = $1V/2^{15}$ referred to ADC input
PF1_RX1_ISQ	2	RMS power in I chain for profile 1, RX channel 1 (post DC and IQ mismatch correction) represented by a 16 bit unsigned number 1 LSB = $1V^2/2^{15}$ referred to ADC input
PF1_RX1_QSQ	2	RMS power in Q chain for profile 1, RX channel 1 (post DC and IQ mismatch correction) represented by a 16 bit unsigned number 1 LSB = $1V^2/2^{15}$ referred to ADC input
PF1_RX1_IQ-CORR	4	Cross correlation between I and Q chains for profile 1, RX channel 1 (post DC and IQ mismatch correction) represented by a 32 bit signed number 1 LSB = $1V^2/2^{30}$ referred to ADC input
PF1_RX2_ICH	2	Residual DC value in I chain for profile 1, RX channel 2 (post DC and IQ mismatch correction) represented by a 16 bit signed number 1 LSB = $1V/2^{15}$ referred to ADC input

Continued on next page

Table 5.65 – continued from previous page

PF1_RX2_QCH	2	Residual DC value in Q chain for profile 1, RX channel 2 (post DC and IQ mismatch correction) represented by a 16 bit signed number 1 LSB = $1V/2^{15}$ referred to ADC input
PF1_RX2_ISQ	2	RMS power in I chain for profile 1, RX channel 2 (post DC and IQ mismatch correction) represented by a 16 bit unsigned number 1 LSB = $1V^2/2^{15}$ referred to ADC input
PF1_RX2_QSQ	2	RMS power in Q chain for profile 1, RX channel 2 (post DC and IQ mismatch correction) represented by a 16 bit unsigned number 1 LSB = $1V^2/2^{15}$ referred to ADC input
PF1_RX2_IQ-CORR	4	Cross correlation between I and Q chains for profile 1, RX channel 2 (post DC and IQ mismatch correction) represented by a 32 bit signed number 1 LSB = $1V^2/2^{30}$ referred to ADC input
PF1_RX3_ICH	2	Residual DC value in I chain for profile 1, RX channel 3 (post DC and IQ mismatch correction) represented by a 16 bit signed number 1 LSB = $1V/2^{15}$ referred to ADC input
PF1_RX3_QCH	2	Residual DC value in Q chain for profile 1, RX channel 3 (post DC and IQ mismatch correction) represented by a 16 bit signed number 1 LSB = $1V/2^{15}$ referred to ADC input
PF1_RX3_ISQ	2	RMS power in I chain for profile 1, RX channel 3 (post DC and IQ mismatch correction) represented by a 16 bit unsigned number 1 LSB = $1V^2/2^{15}$ referred to ADC input
PF1_RX3_QSQ	2	RMS power in Q chain for profile 1, RX channel 3 (post DC and IQ mismatch correction) represented by a 16 bit unsigned number 1 LSB = $1V^2/2^{15}$ referred to ADC input
PF1_RX3_IQ-CORR	4	Cross correlation between I and Q chains for profile 1, RX channel 3 (post DC and IQ mismatch correction) represented by a 32 bit signed number 1 LSB = $1V^2/2^{30}$ referred to ADC input
PF2_RX0_ICH	2	Residual DC value in I chain for profile 2 RX channel 0 (post DC and IQ mismatch correction) represented by a 16 bit signed number 1 LSB = $1V/2^{15}$ referred to ADC input

Continued on next page

Table 5.65 – continued from previous page

PF2_RX0_QCH	2	Residual DC value in Q chain for profile 2, RX channel 0 (post DC and IQ mismatch correction) represented by a 16 bit signed number 1 LSB = $1V/2^{15}$ referred to ADC input
PF2_RX0_ISQ	2	RMS power in I chain for profile 2, RX channel 0 (post DC and IQ mismatch correction) represented by a 16 bit unsigned number 1 LSB = $1V^2/2^{15}$ referred to ADC input
PF2_RX0_QSQ	2	RMS power in Q chain for profile 2, RX channel 0 (post DC and IQ mismatch correction) represented by a 16 bit unsigned number 1 LSB = $1V^2/2^{15}$ referred to ADC input
PF2_RX0_IQ-CORR	4	Cross correlation between I and Q chains for profile 2, RX channel 0 (post DC and IQ mismatch correction) represented by a 32 bit signed number 1 LSB = $1V^2/2^{30}$ referred to ADC input
PF2_RX1_ICH	2	Residual DC value in I chain for profile 2, RX channel 1 (post DC and IQ mismatch correction) represented by a 16 bit signed number 1 LSB = $1V/2^{15}$ referred to ADC input
PF2_RX1_QCH	2	Residual DC value in Q chain for profile 2, RX channel 1 (post DC and IQ mismatch correction) represented by a 16 bit signed number 1 LSB = $1V/2^{15}$ referred to ADC input
PF2_RX1_ISQ	2	RMS power in I chain for profile 2, RX channel 1 (post DC and IQ mismatch correction) represented by a 16 bit unsigned number 1 LSB = $1V^2/2^{15}$ referred to ADC input
PF2_RX1_QSQ	2	RMS power in Q chain for profile 2, RX channel 1 (post DC and IQ mismatch correction) represented by a 16 bit unsigned number 1 LSB = $1V^2/2^{15}$ referred to ADC input
PF2_RX1_IQ-CORR	4	Cross correlation between I and Q chains for profile 2, RX channel 1 (post DC and IQ mismatch correction) represented by a 32 bit signed number 1 LSB = $1V^2/2^{30}$ referred to ADC input
PF2_RX2_ICH	2	Residual DC value in I chain for profile 2, RX channel 2 (post DC and IQ mismatch correction) represented by a 16 bit signed number 1 LSB = $1V/2^{15}$ referred to ADC input

Continued on next page

Table 5.65 – continued from previous page

PF2_RX2_QCH	2	Residual DC value in Q chain for profile 2, RX channel 2 (post DC and IQ mismatch correction) represented by a 16 bit signed number 1 LSB = $1V/2^{15}$ referred to ADC input
PF2_RX2_ISQ	2	RMS power in I chain for profile 2, RX channel 2 (post DC and IQ mismatch correction) represented by a 16 bit unsigned number 1 LSB = $1V^2/2^{15}$ referred to ADC input
PF2_RX2_QSQ	2	RMS power in Q chain for profile 2, RX channel 2 (post DC and IQ mismatch correction) represented by a 16 bit unsigned number 1 LSB = $1V^2/2^{15}$ referred to ADC input
PF2_RX2_IQ-CORR	4	Cross correlation between I and Q chains for profile 2, RX channel 2 (post DC and IQ mismatch correction) represented by a 32 bit signed number 1 LSB = $1V^2/2^{30}$ referred to ADC input
PF2_RX3_ICH	2	Residual DC value in I chain for profile 2, RX channel 3 (post DC and IQ mismatch correction) represented by a 16 bit signed number 1 LSB = $1V/2^{15}$ referred to ADC input
PF2_RX3_QCH	2	Residual DC value in Q chain for profile 2, RX channel 3 (post DC and IQ mismatch correction) represented by a 16 bit signed number 1 LSB = $1V/2^{15}$ referred to ADC input
PF2_RX3_ISQ	2	RMS power in I chain for profile 2, RX channel 3 (post DC and IQ mismatch correction) represented by a 16 bit unsigned number 1 LSB = $1V^2/2^{15}$ referred to ADC input
PF2_RX3_QSQ	2	RMS power in Q chain for profile 2, RX channel 3 (post DC and IQ mismatch correction) represented by a 16 bit unsigned number 1 LSB = $1V^2/2^{15}$ referred to ADC input
PF2_RX3_IQ-CORR	4	Cross correlation between I and Q chains for profile 2, RX channel 3 (post DC and IQ mismatch correction) represented by a 32 bit signed number 1 LSB = $1V^2/2^{30}$ referred to ADC input
PF3_RX0_ICH	2	Residual DC value in I chain for profile 3 RX channel 0 (post DC and IQ mismatch correction) represented by a 16 bit signed number 1 LSB = $1V/2^{15}$ referred to ADC input

Continued on next page

Table 5.65 – continued from previous page

PF3_RX0_QCH	2	Residual DC value in Q chain for profile 3, RX channel 0 (post DC and IQ mismatch correction) represented by a 16 bit signed number 1 LSB = $1V/2^{15}$ referred to ADC input
PF3_RX0_ISQ	2	RMS power in I chain for profile 3, RX channel 0 (post DC and IQ mismatch correction) represented by a 16 bit unsigned number 1 LSB = $1V^2/2^{15}$ referred to ADC input
PF3_RX0_QSQ	2	RMS power in Q chain for profile 3, RX channel 0 (post DC and IQ mismatch correction) represented by a 16 bit unsigned number 1 LSB = $1V^2/2^{15}$ referred to ADC input
PF3_RX0_IQ-CORR	4	Cross correlation between I and Q chains for profile 3, RX channel 0 (post DC and IQ mismatch correction) represented by a 32 bit signed number 1 LSB = $1V^2/2^{30}$ referred to ADC input
PF3_RX1_ICH	2	Residual DC value in I chain for profile 3, RX channel 1 (post DC and IQ mismatch correction) represented by a 16 bit signed number 1 LSB = $1V/2^{15}$ referred to ADC input
PF3_RX1_QCH	2	Residual DC value in Q chain for profile 3, RX channel 1 (post DC and IQ mismatch correction) represented by a 16 bit signed number 1 LSB = $1V/2^{15}$ referred to ADC input
PF3_RX1_ISQ	2	RMS power in I chain for profile 3, RX channel 1 (post DC and IQ mismatch correction) represented by a 16 bit unsigned number 1 LSB = $1V^2/2^{15}$ referred to ADC input
PF3_RX1_QSQ	2	RMS power in Q chain for profile 3, RX channel 1 (post DC and IQ mismatch correction) represented by a 16 bit unsigned number 1 LSB = $1V^2/2^{15}$ referred to ADC input
PF3_RX1_IQ-CORR	4	Cross correlation between I and Q chains for profile 3, RX channel 1 (post DC and IQ mismatch correction) represented by a 32 bit signed number 1 LSB = $1V^2/2^{30}$ referred to ADC input
PF3_RX2_ICH	2	Residual DC value in I chain for profile 3, RX channel 2 (post DC and IQ mismatch correction) represented by a 16 bit signed number 1 LSB = $1V/2^{15}$ referred to ADC input

Continued on next page

Table 5.65 – continued from previous page

PF3_RX2_QCH	2	Residual DC value in Q chain for profile 3, RX channel 2 (post DC and IQ mismatch correction) represented by a 16 bit signed number 1 LSB = $1V/2^{15}$ referred to ADC input
PF3_RX2_ISQ	2	RMS power in I chain for profile 3, RX channel 2 (post DC and IQ mismatch correction) represented by a 16 bit unsigned number 1 LSB = $1V^2/2^{15}$ referred to ADC input
PF3_RX2_QSQ	2	RMS power in Q chain for profile 3, RX channel 2 (post DC and IQ mismatch correction) represented by a 16 bit unsigned number 1 LSB = $1V^2/2^{15}$ referred to ADC input
PF3_RX2_IQ-CORR	4	Cross correlation between I and Q chains for profile 3, RX channel 2 (post DC and IQ mismatch correction) represented by a 32 bit signed number 1 LSB = $1V^2/2^{30}$ referred to ADC input
PF3_RX3_ICH	2	Residual DC value in I chain for profile 3, RX channel 3 (post DC and IQ mismatch correction) represented by a 16 bit signed number 1 LSB = $1V/2^{15}$ referred to ADC input
PF3_RX3_QCH	2	Residual DC value in Q chain for profile 3, RX channel 3 (post DC and IQ mismatch correction) represented by a 16 bit signed number 1 LSB = $1V/2^{15}$ referred to ADC input
PF3_RX3_ISQ	2	RMS power in I chain for profile 3, RX channel 3 (post DC and IQ mismatch correction) represented by a 16 bit unsigned number 1 LSB = $1V^2/2^{15}$ referred to ADC input
PF3_RX3_QSQ	2	RMS power in Q chain for profile 3, RX channel 3 (post DC and IQ mismatch correction) represented by a 16 bit unsigned number 1 LSB = $1V^2/2^{15}$ referred to ADC input
PF3_RX3_IQ-CORR	4	Cross correlation between I and Q chains for profile 3, RX channel 3 (post DC and IQ mismatch correction) represented by a 32 bit signed number 1 LSB = $1V^2/2^{30}$ referred to ADC input

5.11 Sub blocks related to AWR_RF_MISC_CONF_SET_MSG

5.11.1 Sub block 0x02C0 – RESERVED

5.11.2 Sub block 0x02C1 – RESERVED

5.11.3 Sub block 0x02C2 – AWR_RF_TEST_SOURCE_CONFIG_SET_SB

This sub block is used to configure the test source of BSS

NOTE1:	The test source configuration APIs are supported only for debug purpose. Please refer latest DFP release note for more info.
NOTE2:	After test source usage, it is recommend to disable the test source and issue profile configuration API again for normal functionality of radar.

Table 5.66 describes the content of this sub block.

Table 5.66: AWR_RF_TEST_SOURCE_CONFIG_SET_SB contents

Field Name	Number of bytes	Description
SBLKID	2	Value = 0x02C2
SBLKLEN	2	Value = 72
POSITION_VEC1	[2+2+2]	Relative position in Cartesian coordinate from radar to objects, [x, y, z] (all signed, though for y, only unsigned makes sense if forward looking: our radar is on y=0 plane). Object 0 [x,y,z] 1 LSB = 1 cm Valid Range: y: 0 to 32767 cm, x & z: ±32767 cm
VELOCITY_VEC1	[2+2+2]	Relative velocity in Cartesian coordinate, similar to position vector (all signed) Object 0 1 LSB = 1 cm/s Valid Range = +/- 5000 (i.e. +/-180 kmph)
SIG_LEV_VEC1	[2]	Reflecting objects' signal level at ADC output, relative to ADC Full Scale 1 LSB = -0.1 dBFS Valid range: 0 to 950 The same field may be used to emulate enable/disable each object by programming appropriate levels.

Continued on next page

Table 5.66 – continued from previous page

BOUNDARY_ MIN_VEC1	[2+2+2]	Boundary minimum limit for each of x, y, z. When the current position crosses this boundary, the emulator returns the corresponding coordinate to the originally programmed value. Object 1 [x,y,z] 1 LSB = 1 cm Valid Range: y: 0 to 32767 cm, x & z: ± 32767 cm
BOUNDARY_ MAX_VEC1	[2+2+2]	Boundary maximum limit for each of x, y, z. When the current position crosses this boundary, the emulator returns the corresponding coordinate to the originally programmed value. Object 1 [x,y,z] 1 LSB = 1 cm Valid Range: y: 0 to 32767 cm, x & z: ± 32767 cm
POSITION_VEC2	[2+2+2]	Relative position in Cartesian coordinate from radar to objects, [x, y, z] (all signed, though for y, only unsigned makes sense if forward looking: our radar is on y=0 plane). Object 1 [x,y,z] 1 LSB = 1 cm Valid Range: y: 0 to 32767 cm, x & z: ± 32767 cm
VELOCITY_ VEC2	[2+2+2]	Relative velocity in Cartesian coordinate, similar to position vector (all signed) Object 1 1 LSB = 1 cm/s Valid Range = +/- 5000 (i.e. +/-180 kmph)
SIG_LEV_VEC2	[2]	Reflecting objects' signal level at ADC output, relative to ADC Full Scale 1 LSB = -0.1 dBFS Valid range: 0 to 950 The same field may be used to emulate enable/disable each object by programming appropriate levels.
BOUNDARY_ MIN_VEC2	[2+2+2]	Boundary minimum limit for each of x, y, z. When the current position crosses this boundary, the emulator returns the corresponding coordinate to the originally programmed value. Object 1 [x,y,z] 1 LSB = 1 cm Valid Range: y: 0 to 32767 cm, x & z: ± 32767 cm
BOUNDARY_ MAX_VEC2	[2+2+2]	Boundary maximum limit for each of x, y, z. When the current position crosses this boundary, the emulator returns the corresponding coordinate to the originally programmed value. Object 1 [x,y,z] 1 LSB = 1 cm Valid Range: y: 0 to 32767 cm, x & z: ± 32767 cm

Continued on next page

Table 5.66 – continued from previous page

RX_ANT_POS_XZ	8	Receiver Antenna positions to be modeled. The radar is on y=0 plane. Only x and z coordinates to be provided. 1 LSB = Wavelength/8 Valid range = ± 15 wave lengths Byte 0: RX0 X coordinate (may be 0 as reference) Byte 1: RX0 Z (may be 0 as reference) Byte 2: RX1 X Byte 3: RX1 Z Byte 4: RX2 X Byte 5: RX2 Z Byte 6: RX3 X Byte 7: RX3 Z
RESERVED	6	RESERVED
RESERVED	2	Reserved for 4 bytes alignment

NOTE: Test source is not characterized and tuned to 60GHz in xWR6843 devices.

5.11.4 Sub block 0x02C3 – AWR_RF_TEST_SOURCE_ENABLE_SET_SB

This sub block is used to enable test source of BSS
 Table 5.67 describes the content of this sub block.

Table 5.67: AWR_RF_TEST_SOURCE_ENABLE_SET_SB contents

Field Name	Number of bytes	Description
SBLKID	2	Value = 0x02C3
SBLKLEN	2	Value = 8
TS_EN	2	Bit Definition b0 0 Disable (revert to normal functionality) 1 Enable (enter test source functionality) b15:1 RESERVED
RESERVED	2	0x0000

5.11.5 Sub block 0x02C4 – 0x02CB RESERVED

5.11.6 Sub block 0x02CC – AWR_RF_LDO_BYPASS_SB

This sub block enables LDO bypass option within BSS.

CAUTION: Do not enable RF LDO bypass option when the PMIC is configured to supply 1.3V to VIN_13RF1 and VIN_13RF2 analog and RF power supply inputs. This may damage the device. Typically in TI EVMs, PMIC is configured to supply 1.3V to the RF supplies.

Table 5.68 describes the content of this sub block.

Table 5.68: AWR_RF_LDO_BYPASS_SB contents

Field Name	Number of bytes	Description																												
SBLKID	2	Value = 0x02CC																												
SBLKLEN	2	Value = 8																												
RFLDO_BY-PASS_EN	2	<table border="0"> <tr> <td>Bit</td> <td>Description</td> </tr> <tr> <td>b0</td> <td>Value Description</td> </tr> <tr> <td></td> <td>0 RF LDO not bypassed</td> </tr> <tr> <td></td> <td>1 RF LDO bypassed</td> </tr> <tr> <td>b1</td> <td>Value Description</td> </tr> <tr> <td></td> <td>0 PA LDO enabled</td> </tr> <tr> <td></td> <td>1 PA LDO disabled</td> </tr> <tr> <td colspan="2">When simultaneous 3 TX are to be used, to avoid package reliability issues, VIN_13RF2 is shorted to VOUT_PA on the board and the PA LDO should be disabled.</td> </tr> <tr> <td>b15:2</td> <td>RESERVED</td> </tr> <tr> <td colspan="2">The usage of these configurations is as per the table below</td> </tr> <tr> <td>USECASE</td> <td>LDO_ BYPASS PA_LDO_ DISABLE</td> </tr> <tr> <td>1.3V VIN_13RF1 and VIN_13RF2 supplies</td> <td>0 0</td> </tr> <tr> <td>1.0V VIN_13RF1 and VIN_13RF2 supplies</td> <td>1 0</td> </tr> <tr> <td>1.0V VIN_13RF1 and VIN_13RF2 supplies and VIN_13RF2 shorted to VOUT_PA</td> <td>1 1</td> </tr> </table>	Bit	Description	b0	Value Description		0 RF LDO not bypassed		1 RF LDO bypassed	b1	Value Description		0 PA LDO enabled		1 PA LDO disabled	When simultaneous 3 TX are to be used, to avoid package reliability issues, VIN_13RF2 is shorted to VOUT_PA on the board and the PA LDO should be disabled.		b15:2	RESERVED	The usage of these configurations is as per the table below		USECASE	LDO_ BYPASS PA_LDO_ DISABLE	1.3V VIN_13RF1 and VIN_13RF2 supplies	0 0	1.0V VIN_13RF1 and VIN_13RF2 supplies	1 0	1.0V VIN_13RF1 and VIN_13RF2 supplies and VIN_13RF2 shorted to VOUT_PA	1 1
Bit	Description																													
b0	Value Description																													
	0 RF LDO not bypassed																													
	1 RF LDO bypassed																													
b1	Value Description																													
	0 PA LDO enabled																													
	1 PA LDO disabled																													
When simultaneous 3 TX are to be used, to avoid package reliability issues, VIN_13RF2 is shorted to VOUT_PA on the board and the PA LDO should be disabled.																														
b15:2	RESERVED																													
The usage of these configurations is as per the table below																														
USECASE	LDO_ BYPASS PA_LDO_ DISABLE																													
1.3V VIN_13RF1 and VIN_13RF2 supplies	0 0																													
1.0V VIN_13RF1 and VIN_13RF2 supplies	1 0																													
1.0V VIN_13RF1 and VIN_13RF2 supplies and VIN_13RF2 shorted to VOUT_PA	1 1																													

Continued on next page

Table 5.68 – continued from previous page

SUPPLY_MONITOR_IRDROP	1	<p>IR drop is the voltage drop from the PMIC output to the device pin. The user should program the voltage drop in percentage units which will be used for adjusting the thresholds for measuring the external supplies.</p> <p>Value Description</p> <p>0 IR drop of 0%</p> <p>1 IR drop of 3%</p> <p>2 IR drop of 6%</p> <p>3 IR drop of 9%</p>
IO_SUPPLY_INDICATOR	1	<p>IO supply indicator for correct monitoring of IO supply</p> <p>Value Description</p> <p>0 3.3 V IO supply</p> <p>1 1.8 V IO supply</p>

5.11.7 Sub block 0x02CD – AWR_RF_PALOOPBACK_CFG_SB

This sub block enables/disables PA loopback for all enabled profiles. This is used to debug both the TX and RX chains are working correctly.

NOTE: The PA loop-back configuration API is supported only for debug purpose. Please refer latest DFP release note for more info.

Table 5.69 describes the content of this sub block.

NOTE: If monitoring is enabled with the loopback APIs (subblock 0x02CD, 0x02CE, 0x02CF), then loopback will not work after monitoring is complete. To use loopback with monitoring, use AWR_ADVANCED_FRAME_CONF_SB with AWR_LOOPBACK_BURST_CONF_SB.

Table 5.69: AWR_RF_PALOOPBACK_CFG_SB contents

Field Name	Number of bytes	Description
SBLKID	2	Value = 0x02CD
SBLKLEN	2	Value = 8

Continued on next page

Table 5.69 – continued from previous page

PA_LOOPBACK_FREQ	2	<p>This value is a 100 MHz divider which sets the loopback frequency</p> <p>For e.g. for a 1 MHz frequency, set this to 100</p> <p>For a 2 MHz frequency, set this to 50</p> <p>NOTE: To ensure no leakage of signal power, user has to ensure that 100 MHz/LOOPBACK_FREQ is an integer multiple of bin width</p> <p>For e.g. if user chooses 25 Msps sampling rate and 2048 samples/chirp, then LOOPBACK_FREQ of 64 (=1.5625 MHz) will ensure no leakage</p>						
PA_LOOPBACK_EN	1	<table border="0"> <tr> <td>Value</td> <td>Description</td> </tr> <tr> <td>0</td> <td>PA loopback is not enabled</td> </tr> <tr> <td>1</td> <td>PA loopback is enabled</td> </tr> </table>	Value	Description	0	PA loopback is not enabled	1	PA loopback is enabled
Value	Description							
0	PA loopback is not enabled							
1	PA loopback is enabled							
RESERVED	1	0x00						

5.11.8 Sub block 0x02CE – AWR_RF_PSLOOPBACK_CFG_SB

This sub block enables/disables PS (phase shifter) loopback for all enabled profiles. This is used to debug the TX (before the PA) and RX chains.

NOTE: The PS loop-back configuration API is supported only for debug purpose. Please refer latest DFP release note for more info.

Table 5.70 describes the content of this sub block.

NOTE: If monitoring is enabled with the loopback APIs (subblock 0x02CD, 0x02CE, 0x02CF), then loopback will not work after monitoring is complete. To use loopback with monitoring, use AWR_ADVANCED_FRAME_CONF_SB with AWR_LOOPBACK_BURST_CONF_SB.

Table 5.70: AWR_RF_PSLOOPBACK_CFG_SB contents

Field Name	Number of bytes	Description
SBLKID	2	Value = 0x02CE
SBLKLEN	2	Value = 12
PS_LOOPBACK_FREQ	2	Loop back frequency in kHz 1 LSB = 1 kHz
RESERVED	2	0x0000

Continued on next page

Table 5.70 – continued from previous page

PS_LOOPBACK_EN	1	Value	Definition				
		0	PS loopback is not enabled				
		1	PS loopback is enabled				
PS_LOOPBACK_TXID	1	Bit	Definition				
		b0	TX0 is used for loopback				
		b1	TX1 is used for loopback				
		b7:2	RESERVED				
PGA_GAIN_INDEX	1	Value	PGA value	gain	Value	PGA value	gain
		0	PGA is OFF		15	-3 dB	
		1	-22 dB		16	-2 dB	
		2	-16 dB		17	-1 dB	
		3	-15 dB		18	0 dB	
		4	-14 dB		19	1 dB	
		5	-13 dB		20	2 dB	
		6	-12 dB		21	3 dB	
		7	-11 dB		22	4 dB	
		8	-10 dB		23	5 dB	
		9	-9 dB		24	6 dB	
		10	-8 dB		25	7 dB	
		11	-7 dB		26	8 dB	
		12	-6 dB		27	9 dB	
		13	-5 dB		255-28	RESERVED	
14	-4 dB						
RESERVED	1	0x00					

5.11.9 Sub block 0x02CF – AWR_RF_IFLOOPBACK_CFG_SB

This sub block enables/disables IF loopback for all enabled profiles. This is used to debug the RX IF chain.

NOTE: The IF loop-back configuration API is supported only for debug purpose. Please refer latest DFP release note for more info.

Table 5.71 describes the content of this sub block.

NOTE: If monitoring is enabled with the loopback APIs (subblock 0x02CD, 0x02CE, 0x02CF), then loopback will not work after monitoring is complete. To use loopback with monitoring, use AWR_ADVANCED_FRAME_CONF_SB with AWR_LOOPBACK_BURST_CONF_SB.

Table 5.71: AWR_RF_IFLOOPBACK_CFG_SB contents

Field Name	Number of bytes	Description
SBLKID	2	Value = 0x02CF
SBLKLEN	2	Value = 8
IF_LOOPBACK_FREQ	2	Value IF Loopback frequency value 0 180 kHz 1 240 kHz 2 360 kHz 3 720 kHz 4 1 MHz 5 2 MHz 6 2.5 MHz 7 3 MHz 8 4.017857 MHz 9 5 MHz 10 6 MHz 11 8.035714 MHz 12 9 MHz 13 10 MHz 65535-14 RESERVED
IF_LOOPBACK_EN	1	Value Definition 0 IF loopback is not enabled 1 IF loopback is enabled
RESERVED	1	0x00

5.11.10 Sub block 0x02D0 – AWR_RF_GPADC_CFG_SET_SB

This sub block enables the GPADC reads for external inputs (available only in xWR1642/xWR1843/xWR6843). Table 5.72 describes the content of this sub block.

Table 5.72: AWR_RF_GPADC_CFG_SET_SB contents

Field Name	Number of bytes	Description																
SBLKID	2	Value = 0x02D0																
SBLKLEN	2	Value = 32																
SIGNAL_INPUT_ENABLES	1	<p>This field indicates the sets of externally fed DC signals which are to be monitored using GPADC. When each bit in this field is set, the corresponding signal is monitored.</p> <table border="0"> <tr> <td>Bit</td> <td>Definition</td> </tr> <tr> <td>0</td> <td>ANALOGTEST1</td> </tr> <tr> <td>1</td> <td>ANALOGTEST2</td> </tr> <tr> <td>2</td> <td>ANALOGTEST3</td> </tr> <tr> <td>3</td> <td>ANALOGTEST4</td> </tr> <tr> <td>4</td> <td>ANAMUX</td> </tr> <tr> <td>5</td> <td>VSENSE</td> </tr> <tr> <td>Others</td> <td>RESERVED</td> </tr> </table>	Bit	Definition	0	ANALOGTEST1	1	ANALOGTEST2	2	ANALOGTEST3	3	ANALOGTEST4	4	ANAMUX	5	VSENSE	Others	RESERVED
Bit	Definition																	
0	ANALOGTEST1																	
1	ANALOGTEST2																	
2	ANALOGTEST3																	
3	ANALOGTEST4																	
4	ANAMUX																	
5	VSENSE																	
Others	RESERVED																	
SIGNAL_BUFFER_ENABLES	1	<p>This field indicates the sets of externally fed DC signals which are to be buffered before being fed to the GPADC. When each bit in this field is set, the corresponding signal is buffered before the GPADC.</p> <table border="0"> <tr> <td>Bit</td> <td>SIGNAL</td> </tr> <tr> <td>0</td> <td>ANALOGTEST1</td> </tr> <tr> <td>1</td> <td>ANALOGTEST2</td> </tr> <tr> <td>2</td> <td>ANALOGTEST3</td> </tr> <tr> <td>3</td> <td>ANALOGTEST4</td> </tr> <tr> <td>4</td> <td>ANAMUX</td> </tr> <tr> <td>Others</td> <td>RESERVED</td> </tr> </table>	Bit	SIGNAL	0	ANALOGTEST1	1	ANALOGTEST2	2	ANALOGTEST3	3	ANALOGTEST4	4	ANAMUX	Others	RESERVED		
Bit	SIGNAL																	
0	ANALOGTEST1																	
1	ANALOGTEST2																	
2	ANALOGTEST3																	
3	ANALOGTEST4																	
4	ANAMUX																	
Others	RESERVED																	
ANATEST1_CFG	2	<table border="0"> <tr> <td>Bit</td> <td>Definition</td> </tr> <tr> <td>b7:0</td> <td>Number of samples to collect 1 sample takes 1.6 μs</td> </tr> <tr> <td>b15:8</td> <td>Settling time 1 LSB = 0.8 μs Valid range: 0 to 12 μs</td> </tr> </table> <p>Valid programming condition: all the signals that are enabled should take a total of < 100 μs including the programmed settling times and measurement time per enabled signal.</p>	Bit	Definition	b7:0	Number of samples to collect 1 sample takes 1.6 μ s	b15:8	Settling time 1 LSB = 0.8 μ s Valid range: 0 to 12 μ s										
Bit	Definition																	
b7:0	Number of samples to collect 1 sample takes 1.6 μ s																	
b15:8	Settling time 1 LSB = 0.8 μ s Valid range: 0 to 12 μ s																	

Continued on next page

Table 5.72 – continued from previous page

ANATEST2_CFG	2	<p>Bit Definition</p> <p>b7:0 Number of samples to collect 1 sample takes 1.6 μs</p> <p>b15:8 Settling time 1 LSB = 0.8 μs Valid range: 0 to 12 μs</p> <p>Valid programming condition: all the signals that are enabled should take a total of < 100 μs including the programmed settling times and measurement time per enabled signal.</p>
ANATEST3_CFG	2	<p>Bit Definition</p> <p>b7:0 Number of samples to collect 1 sample takes 1.6 μs</p> <p>b15:8 Settling time 1 LSB = 0.8 μs Valid range: 0 to 12 μs</p> <p>Valid programming condition: all the signals that are enabled should take a total of < 100 μs including the programmed settling times and measurement time per enabled signal.</p>
ANATEST4_CFG	2	<p>Bit Definition</p> <p>b7:0 Number of samples to collect 1 sample takes 1.6 μs</p> <p>b15:8 Settling time 1 LSB = 0.8 μs Valid range: 0 to 12 μs</p> <p>Valid programming condition: all the signals that are enabled should take a total of < 100 μs including the programmed settling times and measurement time per enabled signal.</p>
ANAMUX_CFG	2	<p>Bit Definition</p> <p>b7:0 Number of samples to collect 1 sample takes 1.6 μs</p> <p>b15:8 Settling time 1 LSB = 0.8 μs Valid range: 0 to 12 μs</p> <p>Valid programming condition: all the signals that are enabled should take a total of < 100 μs including the programmed settling times and measurement time per enabled signal.</p>

Continued on next page

Table 5.72 – continued from previous page

VSENSE_CFG	2	Bit	Definition
		b7:0	Number of samples to collect 1 sample takes 1.6 μ s
		b15:8	Settling time 1 LSB = 0.8 μ s Valid range: 0 to 12 μ s Valid programming condition: all the signals that are enabled should take a total of < 100 μ s including the programmed settling times and measurement time per enabled signal.
RESERVED	2	0x0000	
RESERVED	4	0x00000000	
RESERVED	4	0x00000000	
RESERVED	4	0x00000000	

The response to the AWR_RF_GPADC_CFG_SET_SB is an async event AWR_AE_RF_GPADC_RESULT_DATA_SB which contains the measured values for each of the enabled channels.

NOTE: The actual measurement of these GPADC signal are done in inter-burst or frame idle time and the result AE sub block will be sent only after completing all the measurements.

5.11.11 Sub block 0x02D1 – RESERVED

5.11.12 Sub block 0x02D2 – RESERVED

5.11.13 Sub block 0x02D3 – RESERVED

5.12 Sub blocks related to AWR_RF_MISC_CONF_GET_MSG

5.12.1 Sub block 0x02E0 to 0x2E9 – RESERVED

5.12.2 Sub block 0x02EA – AWR_RF_TEMPERATURE_GET_SB

This sub block provides the device temperature sensor information.

Table 5.73 describes the content of this sub block.

Table 5.73: AWR_RF_TEMPERATURE_GET_SB contents

Field Name	Number of bytes	Description
SBLKID	2	Value = 0x02EA
SBLKLEN	2	Value = 4

AWR_RF_TEMPERATURE_DATA_SB sub block is sent by the radar device in response to AWR_RF_TEMPERATURE_GET_SB.

Table 5.74: AWR_RF_TEMPERATURE_DATA_SB contents

Field Name	Number of bytes	Description
SBLKID	2	Value = 0x02EA
SBLKLEN	2	Value = 28
TIME	4	BSS local Time from device power up 1 LSB = 1 ms
TEMP_RX0_SENS	2	RX0 temperature sensor reading (signed value) 1 LSB = 1°C
TEMP_RX1_SENS	2	RX1 temperature sensor reading (signed value) 1 LSB = 1°C
TEMP_RX2_SENS	2	RX2 temperature sensor reading (signed value) 1 LSB = 1°C
TEMP_RX3_SENS	2	RX3 temperature sensor reading (signed value) 1 LSB = 1°C
TEMP_TX0_SENS	2	TX0 temperature sensor reading (signed value) 1 LSB = 1°C
TEMP_TX1_SENS	2	TX1 temperature sensor reading (signed value) 1 LSB = 1°C
TEMP_TX2_SENS	2	TX2 temperature sensor reading (signed value) 1 LSB = 1°C
TEMP_PM_SENS	2	PM temperature sensor reading (signed value) 1 LSB = 1°C
TEMP_DIG1_SENS	2	Digital temperature sensor reading (signed value) 1 LSB = 1°C
TEMP_DIG2_SENS	2	Digital temperature sensor reading (signed value) [Applicable only in xWR1642/xWR6843/xWR1843] 1 LSB = 1°C

5.13 Sub blocks related to AWR_RF_ASYNC_EVENT_MSG1

NOTE1: All the Monitoring Async events will be sent out periodically at CAL_MON_TIME_UNIT frame rate (FTTI). The RadarSS/BSS has a queue to hold max 8 transmit API messages (AEs or Responses), the host shall service all the AEs before start of the next FTTI epoch to avoid RadarSS Queue full CPU fault fatal error.

NOTE2: In reporting mode 1 (Quiet mode) if any failure in RadarSS analog or digital monitors the AWR1243 device will send AWR_AE_MSS_RFERROR_STATUS_SB AE with error code 0x7 along with failure monitoring report.

5.13.1 Sub block 0x1000 – RESERVED

5.13.2 Sub block 0x1001 – RESERVED

5.13.3 Sub block 0x1002 – AWR_AE_RF_CPUFAULT_SB

This sub block indicates CPU fault status of BIST SS.
 Table 5.75 describes the content of this sub block.

Table 5.75: AWR_AE_RF_CPUFAULT_SB response contents

Field Name	Number of bytes	Description
SBLKID	2	Value = 0x1002
SBLKLEN	2	Value = 36
FAULT_TYPE	1	Value Definition 0 RF Processor Undefined Instruction Abort 1 RF Processor Instruction pre-fetch Abort 2 RF Processor Data Access Abort 3 RF Processor Firmware Fatal Error 0x4 - RESERVED 0xFE 0xFF No fault
RESERVED	1	0x00
LINE_NUM	2	Valid only in case of FAULT type is 0x3, provides the firmware line number at which fatal error occurred.
FAULT_LR	4	The instruction PC address at which Fault occurred

Continued on next page

Table 5.75 – continued from previous page

FAULT_PREV_LR	4	The return address of the function from which fault function has been called (Call stack LR)
FAULT_SPSR	4	The CPSR register value at which fault occurred
FAULT_SP	4	The SP register value at which fault occurred
FAULT_CAUSE_ADDRESS	4	The address access at which Fault occurred (valid only for fault type 0x0 to 0x2)
FAULT_ERROR_STATUS	2	The status of Error (Error Cause type – valid only for fault type 0x0 to 0x2) 0x000 BACKGROUND_ERR 0x001 ALIGNMENT_ERR 0x002 DEBUG_EVENT 0x00D PERMISSION_ERR 0x008 SYNCH_EXTER_ERR 0x406 ASYNCH_EXTER_ERR 0x409 SYNCH_ECC_ERR 0x408 ASYNCH_ECC_ERR
FAULT_ERROR_SOURCE	1	The Source of the Error (Error Source type - valid only for fault type 0x0 to 0x2) 0x0 ERR_SOURCE_AXI_MASTER 0x1 ERR_SOURCE_ATCM 0x2 ERR_SOURCE_BTCM
FAULT_AXI_ERROR_TYPE	1	The AXI Error type (Error Source type - valid only for fault type 0x0 to 0x2) 0x0 AXI_DECOD_ERR 0x1 AXI_SLAVE_ERR
FAULT_ACCESS_TYPE	1	The Error Access type (Error Access type - valid only for fault type 0x0 to 0x2) 0x0 READ_ERR 0x1 WRITE_ERR
FAULT_RECOVERY_TYPE	1	The Error Recovery type (Error Recovery type - Valid only for fault type 0x0 to 0x2) 0x0 UNRECOVERY 0x1 RECOVERY
RESERVED	2	0x0000

5.13.4 Sub block 0x1003 – AWR_AE_RF_ESMFAULT_SB

This sub block indicates the status of any other faults in the BIST SS.

Table 5.76 describes the content of this sub block.

Table 5.76: AWR_AE_RF_ESMFAULT_STATUS_SB response contents

Field Name	Number of bytes	Description
SBLKID	2	Value = 0x1003
SBLKLEN	2	Value = 12
ESM_GROUP1_ERRORS	4	Bit Error Information b0 RAMPGEN_SB_ERROR b1 RESERVED b2 GPADC_RAM_SB_ERROR b3 VIM_RAM_SB_ERROR b4 DFE_SELFTEST_ERROR b5 VIM_SELFTEST_ERROR b6 B0TCM_SB_ERROR b7 B1TCM_SB_ERROR b8 CCMR4_SELFTEST_ERROR b9 ATCM_SB_ERROR b10 RAMPGEN_SELFTEST_ERROR b11 RAMPGEN_PAR_SELFTEST_ERROR b12 SEQ_EXT_SELFTEST_ERROR b13 SEQ_EXT_SB_ERROR b14 PROG_FILT_FATAL_PARITY_ERROR b15 AGC_RAM_SB_ERROR b16 B1TCM_PAR_CHK_ERROR b17 B0TCM_PAR_CHK_ERROR b18 ATCM_PAR_CHK_ERROR b19 MB_MSS2BSS_SB_ERROR b20 MB_BSS2MSS_SB_ERROR b24:21 RESERVED b25 PROG_FILT_FATAL_DB_ECC_ERROR b31:26 RESERVED

Continued on next page

Table 5.76 – continued from previous page

ESM_GROUP2_ ERRORS	4	Bit	Error Information
		b0	DFE_STC_ERROR
		b1	CR4_STC_ERROR
		b2	CCMR4_COMP_ERROR
		b3	B0TCM_DB_ERROR
		b4	B1TCM_DB_ERROR
		b5	ATCM_DB_ERROR
		b6	DCC_ERROR
		b7	SEQ_EXT_ERROR
		b8	SYNT_FREQ_MON_ERROR
		b9	DFE_PARITY_ERROR
		b10	RAMPGEN_DB_ERROR
		b11	BUBBLE_CORRECTION_FAIL
		b12	RAMPGEN_LOCSTEP_ERROR
		b13	RTI_RESET_ERROR
		b14	GPADC_RAM_DB_ERROR
		b15	VIM_COMP_ERROR
		b16	CR4_LIVE_LOCK_ERROR
		b17	WDT_NMI_ERROR
		b18	VIM_RAM_DB_ERROR
		b19	RAMPGEN_PAR_ERROR
		b20	SEQ_EXT_DB_ERROR
		b21	DMA_MPU_ERROR
		b22	AGC_RAM_DB_ERROR
		b23	CRC_COMP_ERROR
		b24	WAKEUP_STS_ERROR
		b25	SHORT_CIRCUIT_ERROR
		b26	B1TCM_PAR_ERROR
		b27	B0TCM_PAR_ERROR
		b28	ATCM_PAR_ERROR
		b29	MB_MSS2BSS_DB_ERROR
		b30	MB_BSS2MSS_DB_ERROR
b31	CCC_ERROR		

NOTE: The Programmable filter Parity error and double bit ECC fatal errors are connected to ESM Group 1 lines, these fatal errors must be handled in Host (MSS or DSS in xWR1642, xWR1843 and xWR6843 devices)

5.13.5 Sub block 0x1004 – AWR_AE_RF_INITCALIBSTATUS_SB

This sub block indicates the initial calibrations of RF BIST SS are complete. Table 5.77 describes the content of this sub block.

Table 5.77: AWR_AE_RF_INITCALIBSTATUS_SB response contents

Field Name	Number of bytes	Description
SBLKID	2	Value = 0x1004
SBLKLEN	2	Value = 24
CALIBRATION_STATUS	4	This field indicates the status of each calibration (0 – FAIL, 1 – PASS). If a particular calibration was not enabled, then its corresponding field should be ignored. Bit Definition (0 – FAIL, 1 – PASS) b0 RESERVED b1 APLL tuning b2 SYNTH VCO1 tuning b3 SYNTH VCO2 tuning b4 LODIST calibration b5 RX ADC DC offset calibration b6 HPF cutoff calibration b7 LPF cutoff calibration b8 Peak detector calibration b9 TX Power calibration b10 RX gain calibration b11 TX Phase calibration b12 RX IQMM calibration b31:13 RESERVED

Continued on next page

Table 5.77 – continued from previous page

CALIBRATION_UPDATE	4	<p>This field indicates if a particular calibration data has been updated in hardware. (0 – no update, 1 – updated)</p> <p>Bit Definition</p> <p>b0 RESERVED</p> <p>b1 APLL tuning</p> <p>b2 SYNTH VCO1 tuning</p> <p>b3 SYNTH VCO2 tuning</p> <p>b4 LODIST calibration</p> <p>b5 RX ADC DC offset calibration</p> <p>b6 HPF cutoff calibration</p> <p>b7 LPF cutoff calibration</p> <p>b8 Peak detector calibration</p> <p>b9 TX Power calibration</p> <p>b10 RX gain calibration</p> <p>b11 TX Phase calibration</p> <p>b12 RX IQMM calibration</p> <p>b31:13 RESERVED</p>
TEMPERATURE	2	<p>Measured temperature, based on average of temperature sensors near all enabled TX and RX channels at the time of calibration.</p> <p>1 LSB = 1°C</p>
RESERVED	2	0x0000
TIME_STAMP	4	<p>This field indicates time stamp at the time of performing calibration updates.</p> <p>1 LSB = 1 millisecond (time stamp rolls over upon exceeding allotted bit width)</p>
RESERVED	4	0x00000000

5.13.6 Sub block 0x1005 – RESERVED
5.13.7 Sub block 0x1006 – RESERVED
5.13.8 Sub block 0x1007 – RESERVED
5.13.9 Sub block 0x1008 – RESERVED
5.13.10 Sub block 0x1009 – RESERVED
5.13.11 Sub block 0x100A – RESERVED
5.13.12 Sub block 0x100B – AWR_AE_RF_FRAME_TRIGGER_RDY_SB

This sub block indicates that the slave device is now ready to receive the external sync in for frame triggers, this does not indicate physical trigger of frames in Hw triggered mode. In SW triggered mode, this async event indicates that frame is triggered by Sw.

Table 5.78 describes the content of this sub block.

Table 5.78: AWR_AE_RF_FRAME_TRIGGER_RDY_SB response contents

Field Name	Number of bytes	Description
SBLKID	2	Value = 0x100B
SBLKLEN	2	Value = 4

5.13.13 Sub block 0x100C – AWR_AE_RF_GPADC_RESULT_DATA_SB

This sub block indicates that GPADC measurement is complete and it also contains the measured data of each of the enabled channels. The data for channels which are not enabled can be ignored.

Table 5.79 describes the content of this sub block.

Table 5.79: AWR_AE_RF_GPADC_RESULT_DATA_SB response contents

Field Name	Number of bytes	Description
SBLKID	2	Value = 0x100C
SBLKLEN	2	Value = 76
ANATEST1_MIN_DATA	2	Minimum GPADC reading across the captured samples for ANATEST1 input 1 LSB = 1.8V/1024
ANATEST1_MAX_DATA	2	Maximum GPADC reading across the captured samples for ANATEST1 input 1 LSB = 1.8V/1024

Continued on next page

Table 5.79 – continued from previous page

ANATEST1_ AVG_DATA	2	Average GPADC reading across the captured samples for ANATEST1 input 1 LSB = 1.8V/1024
ANATEST2_MIN_ DATA	2	Minimum GPADC reading across the captured samples for ANATEST2 input 1 LSB = 1.8V/1024
ANATEST2_ MAX_DATA	2	Maximum GPADC reading across the captured samples for ANATEST2 input 1 LSB = 1.8V/1024
ANATEST2_ AVG_DATA	2	Average GPADC reading across the captured samples for ANATEST2 input 1 LSB = 1.8V/1024
ANATEST3_MIN_ DATA	2	Minimum GPADC reading across the captured samples for ANATEST3 input 1 LSB = 1.8V/1024
ANATEST3_ MAX_DATA	2	Maximum GPADC reading across the captured samples for ANATEST3 input 1 LSB = 1.8V/1024
ANATEST3_ AVG_DATA	2	Average GPADC reading across the captured samples for ANATEST3 input 1 LSB = 1.8V/1024
ANATEST4_MIN_ DATA	2	Minimum GPADC reading across the captured samples for ANATEST4 input 1 LSB = 1.8V/1024
ANATEST4_ MAX_DATA	2	Maximum GPADC reading across the captured samples for ANATEST4 input 1 LSB = 1.8V/1024
ANATEST4_ AVG_DATA	2	Average GPADC reading across the captured samples for ANATEST4 input 1 LSB = 1.8V/1024
ANAMUX_MIN_ DATA	2	Minimum GPADC reading across the captured samples for ANAMUX input 1 LSB = 1.8V/1024
ANAMUX_MAX_ DATA	2	Maximum GPADC reading across the captured samples for ANAMUX input 1 LSB = 1.8V/1024
ANAMUX_AVG_ DATA	2	Average GPADC reading across the captured samples for ANAMUX input 1 LSB = 1.8V/1024
VSENSE_MIN_ DATA	2	Minimum GPADC reading across the captured samples for VSENSE input 1 LSB = 1.8V/1024

Continued on next page

Table 5.79 – continued from previous page

VSENSE_MAX_DATA	2	Maximum GPADC reading across the captured samples for VSENSE input 1 LSB = 1.8V/1024
VSENSE_AVG_DATA	2	Average GPADC reading across the captured samples for VSENSE input 1 LSB = 1.8V/1024
RESERVED	2	0x0000
RESERVED	2	0x0000
RESERVED	2	0x0000
RESERVED	2	0x0000
RESERVED	4	0x00000000
RESERVED	4	0x00000000
RESERVED	4	0x00000000
RESERVED	4	0x00000000
RESERVED	4	0x00000000
RESERVED	4	0x00000000
RESERVED	4	0x00000000
RESERVED	4	0x00000000

5.13.14 Sub block 0x100E – RESERVED
5.13.15 Sub block 0x100D – RESERVED
5.13.16 Sub block 0x100E – RESERVED
5.13.17 Sub block 0x100F – AWR_FRAME_END_AE_SB

This sub block indicates end of the frames.

Table 5.80 describes the content of this sub block.

Table 5.80: AWR_FRAME_END_AE_SB response contents

Field Name	Number of bytes	Description
SBLKID	2	Value = 0x100F
SBLKLEN	2	Value = 4

5.13.18 Sub block 0x1010 – AWR_ANALOGFAULT_AE_SB

This sub block indicates fault in analog supplies or LDO short circuit condition. Once a fault is detected the functionality cannot be resumed from then on and the sensor needs to be re-started.

Table 5.81: AWR_ANALOGFAULT_AE_SB response contents

Field Name	Number of bytes	Description
SBLKID	2	Value = 0x1010
SBLKLEN	2	Value = 16
FAULT_TYPE	1	Value Definition 0 NO FAULT 1 ANALOG_SUPPLY_FAULT Others RESERVED
RESERVED	1	0x00
RESERVED	2	0x0000
FAULT_SIG	4	Bit Definition b0 1.8V BB ANA supply fault detected b1 13V/1.0V RF supply fault detected b2 Synth VCO LDO short circuit detected b3 PA LDO short circuit detected b31:4 RESERVED
RESERVED	4	0x00000000

5.13.19 Sub block 0x1011 – AWR_CAL_MON_TIMING_FAIL_REPORT_AE_SB

This sub block indicates any timing failure related to calibration or monitoring.

Table 5.82 describes the content of this sub block.

Table 5.82: AWR_CAL_MON_TIMING_FAIL_REPORT_AE_SB response contents

Field Name	Number of bytes	Description
SBLKID	2	Value = 0x1011
SBLKLEN	2	Value = 8

Continued on next page

Table 5.82 – continued from previous page

TIMING_FAILURE_CODE	2	Bit	Definition	
		b0	RESERVED	
		b1	0	No Failure
			1	Total monitoring and calibration time do not fit in one CALIB_MON_TIME_UNIT in AWR_RUN_TIME_CALIBRATION_CONF_AND_TRIGGER when ONE_TIME_CALIB is enabled
		b2	0	No Failure
1	Total monitoring and calibration time do not fit in one CALIB_MON_TIME_UNIT in AWR_RUN_TIME_CALIBRATION_CONF_AND_TRIGGER when PERIODIC_CALIB is enabled			
b3	0	No Failure		
	1	Runtime timing violation: Monitoring functions or calibrations could not be completed in one CALIB_MON_TIME_UNIT		
		b15:4	RESERVED	
RESERVED	2	0x0000		

NOTE: In QM devices (non safety), Periodic Digital and Analog Monitoring are not supported.

5.13.20 Sub block 0x1012 – AWR_RUN_TIME_CALIB_SUMMARY_REPORT_AE_SB

This sub block indicates the calibration status (one time or run time) if the calibration reports are enabled in the AWR_RUN_TIME_CALIBRATION_CONF_AND_TRIGGER_SB.

NOTE: The calibration report is sent if the calibrations are triggered due to temperature change or whenever the internal calibrations are triggered i.e. every 1 s

Table 5.83: AWR_RUN_TIME_CALIB_SYMMARY_REPORT_AE_SB response contents

Field Name	Number of bytes	Description
SBLKID	2	Value = 0x1012
SBLKLEN	2	Value = 24
CALIBRATION_ERROR_FLAG	4	<p>This field indicates the status of each calibration. 1 - calibration is passed, 0 - calibration is failed or not enabled/performed at least once.</p> <p>Bit Definition</p> <p>b0 RESERVED</p> <p>b1 APLL tuning</p> <p>b2 SYNTH VCO1 tuning</p> <p>b3 SYNTH VCO2 tuning</p> <p>b4 LODIST calibration</p> <p>b5 RESERVED</p> <p>b6 RESERVED</p> <p>b7 RESERVED</p> <p>b8 PD calibration</p> <p>b9 TX power calibration</p> <p>b10 RX gain calibration</p> <p>b11 RESERVED</p> <p>b12 RESERVED</p> <p>b31:13 RESERVED</p>

Continued on next page

Table 5.83 – continued from previous page

CALIBRATION_UPDATE_STATUS	4	<p>Each bit corresponding to a calibration indicates if each calibration resulted in a reconfiguration of RF is indicated by a value of 1 in the respective bit in this field.</p> <p>0 – Analog/RF is not updated 1 – Analog/RF is updated after a respective calibration</p> <p>Bit Definition</p> <p>b0 RESERVED</p> <p>b1 APLL tuning</p> <p>b2 SYNTH VCO1 tuning</p> <p>b3 SYNTH VCO2 tuning</p> <p>b4 LODIST calibration</p> <p>b5 RESERVED</p> <p>b6 RESERVED</p> <p>b7 RESERVED</p> <p>b8 PD calibration</p> <p>b9 TX power calibration</p> <p>b10 RX gain calibration</p> <p>b11 RESERVED</p> <p>b12 RESERVED</p> <p>b31:13 RESERVED</p>
TEMPERATURE	2	<p>Measured temperature, based on average of temperature sensors near all enabled TX and RX channels at the time of calibration. Note that this temperature will be updated only when a run-time calibration is executed due to a change in temperature by more than 10 deg C.</p> <p>1 LSB = 1°C</p>
RESERVED	2	RESERVED
TIME_STAMP	4	<p>This field indicates time stamp at the time of performing calibration updates.</p> <p>1 LSB = 1 millisecond (time stamp rolls over upon exceeding allotted bit width)</p>
RESERVED	4	0x00000000

NOTE: None of the Periodic Monitoring are supported in QM devices (xWR6843 QM, xWR1443, IWR1642 and IWR1843), The Async Event sub-blocks defined below from ID 0x1015 to 0x1031 are not valid in QM devices.

5.13.21 Sub block 0x1013 – AWR_MONITOR_RF_DIG_LATENTFAULT_REPORT_AE_SB

This async event contains the status of digital monitoring for latent faults.

Table 5.84: AWR_MONITOR_RF_DIG_LATENTFAULT_REPORT_AE_SB response contents

Field Name	Number of bytes	Description
SBLKID	2	Value = 0x1013
SBLKLEN	2	Value = 8

Continued on next page

Table 5.84 – continued from previous page

DIG_MON_LATENT_FAULT_STATUS	4	1 – PASS, 0 – FAIL
		Bit Definition
		b0 RESERVED
		b1 CR4 and VIM lockstep test
		b2 RESERVED
		b3 VIM test (Not supported in 1st Gen devices, refer latest release note)
		b4 RESERVED
		b5 RESERVED
		b6 CRC test
		b7 RAMPGEN memory ECC test (Not supported in 1st Gen devices, refer latest release note)
		b8 DFE Parity test
		b9 DFE memory ECC test
		b10 RAMPGEN lockstep test
		b11 FRC lockstep test
		b12 RESERVED
		b13 RESERVED
		b14 RESERVED
		b15 RESERVED
		b16 ESM test
		b17 DFE STC
		b18 RESERVED
		b19 ATCM, BTCM ECC test
		b20 ATCM, BTCM parity test
		b21 RESERVED
		b22 RESERVED
		b23 RESERVED
		b24 FFT test
		b25 RTI test
b26 RESERVED		
b31:27 RESERVED		

5.13.22 Sub block 0x1014 – RESERVED

5.13.23 Sub block 0x1015 – AWR_MONITOR_REPORT_HEADER_AE_SB

The report header includes common information across all enabled monitors like current FTTI number and current temperature.

Table 5.85: AWR_MONITORING_REPORT_HEADER_AE_SB response contents

Field Name	Number of bytes	Description
SBLKID	2	Value = 0x1015
SBLKLEN	2	Value = 12
FTTI_COUNT	4	FTTI free running counter value, incremented every CAL_MON_TIME_UNIT
AVG_TEMPERATURE	2	Average temperature at which was monitoring performed
RESERVED	2	0x0000

5.13.24 Sub block 0x1016 – AWR_MONITOR_RF_DIG_PERIODIC_REPORT_AE_SB

This async event is sent periodically to indicate the status of periodic digital monitoring tests.

Table 5.86: AWR_MONITOR_RF_DIG_PERIODIC_REPORT_AE_SB contents

Field Name	Number of bytes	Description
SBLKID	2	Value = 0x1016
SBLKLEN	2	Value = 12
RF_DIG_MON_PERIODIC_STATUS	4	1 – PASS, 0 – FAIL Bit Monitoring type b0 PERIODIC_CONFIG_REGISTER_READ b1 RESERVED b2 DFE_STC b3 FRAME_TIMING_MONITORING b31:4 RESERVED

Continued on next page

Table 5.86 – continued from previous page

TIMESTAMP	4	This field indicates when the last monitoring in the enabled set was performed. 1 LSB = 1 millisecond (time stamp rolls over upon exceeding allotted bit width)
-----------	---	--------------------------------------------------------------------------------------------------------------------------------------------------------------------

5.13.25 Sub block 0x1017 – AWR_MONITOR_TEMPERATURE_REPORT_AE_SB

This API is a Monitoring Report API which the AWR device sends to the host, containing the measured temperature near various RF analog and digital modules. The AWR device sends this to host at the programmed periodicity or when failure occurs, as programmed by the configuration API SB.

Table 5.87: AWR_MONITORING_TEMPERATURE_REPORT_AE_SB contents

Field Name	Number of bytes	Description
SBLKID	2	Value = 0x1017
SBLKLEN	2	Value = 36
STATUS_FLAGS	2	Status flags indicating pass fail results corresponding to various threshold checks under this monitor. Bit STATUS_FLAG for monitor b0 STATUS_ANA_TEMP_MIN b1 STATUS_ANA_TEMP_MAX b2 STATUS_DIG_TEMP_MIN b3 STATUS_DIG_TEMP_MAX b4 STATUS_TEMP_DIFF_THRESH b15:5 RESERVED 0 – FAIL or check wasn't done 1 – PASS
ERROR_CODE	2	Indicates any error reported during monitoring Value of 0 indicates no error

Continued on next page

Table 5.88 – continued from previous page

STATUS_FLAGS	2	<p>Status flag indicating pass fail results corresponding to various threshold checks under this monitor.</p> <p>Bit STATUS_FLAG for monitor</p> <p>b0 STATUS_RX_GAIN_ABS</p> <p>b1 STATUS_RX_GAIN_MISMATCH</p> <p>b2 STATUS_RX_GAIN_FLATNESS</p> <p>b3 STATUS_RX_PHASE_MISMATCH</p> <p>b15:4 RESERVED</p> <p>0 – FAIL or check wasn't done</p> <p>1 – PASS</p>									
ERROR_CODE	2	<p>Indicates any error reported during monitoring</p> <p>Value of 0 indicates no error</p>									
PROFILE_INDX	1	<p>Profile Index for which this monitoring report applies.</p>									
LOOPBACK_POWER	3	<p>The measured average loop-back power across RX channels at each enabled RF frequency (i.e., lowest, center and highest with 60MHz dither in the profile's RF band) at LNA input is reported here.</p> <p>Byte numbers corresponding to different RF, in this field are here:</p> <table style="margin-left: auto; margin-right: auto;"> <tr> <td style="text-align: center;">RF1</td> <td style="text-align: center;">RF2</td> <td style="text-align: center;">RF3</td> </tr> <tr> <td style="text-align: center;">(Byte 0)</td> <td style="text-align: center;">(Byte 1)</td> <td style="text-align: center;">(Byte 2)</td> </tr> <tr> <td style="text-align: center;">b4:b0</td> <td style="text-align: center;">b4:b0</td> <td style="text-align: center;">b4:b0</td> </tr> </table> <p>b7-b5 : RESERVED in each bytes</p> <p>1 LSB = -2 dBm</p> <p>Valid Range = -62dBm to 0dBm</p> <p>Only the entries of enabled RF Frequencies are valid.</p> <p>The LB power might be bad/corrupted under interference conditions.</p>	RF1	RF2	RF3	(Byte 0)	(Byte 1)	(Byte 2)	b4:b0	b4:b0	b4:b0
RF1	RF2	RF3									
(Byte 0)	(Byte 1)	(Byte 2)									
b4:b0	b4:b0	b4:b0									

Continued on next page

Table 5.88 – continued from previous page

RX_GAIN_VALUE	24	<p>The measured RX gain for each enabled channel, at each enabled RF frequency (i.e., lowest, center and highest in the profile's RF band) is reported here.</p> <p>Byte numbers corresponding to different RX and RF, in this field are here:</p> <table border="1" data-bbox="662 515 1037 716"> <thead> <tr> <th></th> <th>RF1</th> <th>RF2</th> <th>RF3</th> </tr> </thead> <tbody> <tr> <td>RX0</td> <td>1:0</td> <td>9:8</td> <td>17:16</td> </tr> <tr> <td>RX1</td> <td>3:2</td> <td>11:10</td> <td>19:18</td> </tr> <tr> <td>RX2</td> <td>5:4</td> <td>13:12</td> <td>21:20</td> </tr> <tr> <td>RX3</td> <td>7:6</td> <td>15:14</td> <td>23:22</td> </tr> </tbody> </table> <p>1 LSB = 0.1 dB</p> <p>Only the entries of enabled RF Frequencies and enabled RX channels are valid.</p> <p>NOTE:</p> <p>The RX_GAIN_VALUE is measured using only ADC power and under assumption of a fixed LB power for all RF1, RF2 and RF3 frequencies to avoid interference impact. Therefore, RX_GAIN_VALUE shows around 10 dB deviation from programmed RX gain across full temperature range.</p> <p>xWR1xxx devices:</p> <p>The actual Rx gain of the device in dB = RX GAIN VALUE(Rf freq, Rx) + (-38dBm) – LOOPBACK_POWER_TEMP_dBm(Temp[C])</p> <p>Where LOOPBACK_POWER_TEMP_dBm (Temp[C]) = $-0.07 * \text{Temp}[C] - 34$</p> <p>Loopback power is -38 dBm around 50 C, and decreases with slope of -7 dBm/100C. These formulae can be used for monitoring reports not affected by interference.</p> <p>xWR6x43 devices:</p> <p>The actual Rx gain of the device in dB = RX GAIN VALUE(Rf freq, Rx) + (-54dBm) – LOOPBACK_POWER_TEMP_dBm(Temp[C])</p> <p>Where LOOPBACK_POWER_TEMP_dBm (Temp[C]) = $-0.06 * \text{Temp}[C] - 51.6$</p> <p>Loopback power is -54 dBm around 50 C, and decreases with slope of -6 dBm/100C. These formulae can be used for monitoring reports not affected by interference.</p>		RF1	RF2	RF3	RX0	1:0	9:8	17:16	RX1	3:2	11:10	19:18	RX2	5:4	13:12	21:20	RX3	7:6	15:14	23:22
	RF1	RF2	RF3																			
RX0	1:0	9:8	17:16																			
RX1	3:2	11:10	19:18																			
RX2	5:4	13:12	21:20																			
RX3	7:6	15:14	23:22																			

Continued on next page

Table 5.88 – continued from previous page

RX_PHASE_VALUE	24	<p>The measured RX phase for each enabled channel, at each enabled RF frequency is reported here.</p> <p>Byte numbers corresponding to different RX and RF, in this field are here:</p> <table border="1" data-bbox="662 488 1029 683"> <thead> <tr> <th></th> <th>RF1</th> <th>RF2</th> <th>RF3</th> </tr> </thead> <tbody> <tr> <td>RX0</td> <td>1:0</td> <td>9:8</td> <td>17:16</td> </tr> <tr> <td>RX1</td> <td>3:2</td> <td>11:10</td> <td>19:18</td> </tr> <tr> <td>RX2</td> <td>5:4</td> <td>13:12</td> <td>21:20</td> </tr> <tr> <td>RX3</td> <td>7:6</td> <td>15:14</td> <td>23:22</td> </tr> </tbody> </table> <p>1 LSB = $360^\circ/2^{16}$</p> <p>Only the entries of enabled RF Frequencies and enabled RX channels are valid.</p> <p>NOTE: These phases include an unknown bias common to all RX channels.</p>		RF1	RF2	RF3	RX0	1:0	9:8	17:16	RX1	3:2	11:10	19:18	RX2	5:4	13:12	21:20	RX3	7:6	15:14	23:22
	RF1	RF2	RF3																			
RX0	1:0	9:8	17:16																			
RX1	3:2	11:10	19:18																			
RX2	5:4	13:12	21:20																			
RX3	7:6	15:14	23:22																			
RX_NOISE_POWER1	4	<p>The measured RX noise for each enabled channel, at each enabled RF frequency is reported here.</p> <p>Bit fields corresponding to different RX in RF1 and RF2 (partial in this word) are defined in this field:</p> <table border="1" data-bbox="662 1025 1061 1220"> <thead> <tr> <th></th> <th>RF1</th> <th>RF2</th> <th>RF3</th> </tr> </thead> <tbody> <tr> <td>RX0</td> <td>b4:b0</td> <td>b24:b20</td> <td>-</td> </tr> <tr> <td>RX1</td> <td>b9:b5</td> <td>b29:b25</td> <td>-</td> </tr> <tr> <td>RX2</td> <td>b14:b10</td> <td>-</td> <td>-</td> </tr> <tr> <td>RX3</td> <td>b19:b15</td> <td>-</td> <td>-</td> </tr> </tbody> </table> <p>b31-b30 : RESERVED</p> <p>1 LSB = -2dBm</p> <p>Valid Range: -62dbm to 0dBm</p> <p>Only the entries of enabled RF Frequencies and enabled RX channels are valid.</p> <p>NOTE: Noise Power shows a decreasing trend with temperature with average noise power being -43 dBm at 50 C and decreasing with slope = -8 dBm/100C .</p> <p>Noise_Power_dBm (Temp[C]) = $-0.08 * \text{Temp [C]} - 39$</p> <p>Noise Power can be used for detecting the monitoring reports impacted by interference.</p>		RF1	RF2	RF3	RX0	b4:b0	b24:b20	-	RX1	b9:b5	b29:b25	-	RX2	b14:b10	-	-	RX3	b19:b15	-	-
	RF1	RF2	RF3																			
RX0	b4:b0	b24:b20	-																			
RX1	b9:b5	b29:b25	-																			
RX2	b14:b10	-	-																			
RX3	b19:b15	-	-																			

Continued on next page

Table 5.88 – continued from previous page

RX_NOISE_POWER2	4	<p>The measured RX noise for each enabled channel, at each enabled RF frequency is reported here.</p> <p>Bit fields corresponding to different RX in RF2 (partial in this word) and RF3 are defined in this field:</p> <table border="1" data-bbox="654 492 1085 694"> <thead> <tr> <th></th> <th>RF1</th> <th>RF2</th> <th>RF3</th> </tr> </thead> <tbody> <tr> <td>RX0</td> <td>-</td> <td>-</td> <td>b14:b10</td> </tr> <tr> <td>RX1</td> <td>-</td> <td>-</td> <td>b19:b15</td> </tr> <tr> <td>RX2</td> <td>-</td> <td>b4:b0</td> <td>b24:b20</td> </tr> <tr> <td>RX3</td> <td>-</td> <td>b9:b5</td> <td>b29:b25</td> </tr> </tbody> </table> <p>b31-b30 : RESERVED 1 LSB = -2dBm Valid Range: -62dbm to 0dBm Only the entries of enabled RF Frequencies and enabled RX channels are valid.</p> <p>NOTE: Noise Power shows a decreasing trend with temperature with average noise power being -43 dBm at 50 C and decreasing with slope = -8 dBm/100C .</p> <p>Noise_Power_dBm (Temp[C]) = -0.08 * Temp [C] -39</p> <p>Noise Power can be used for detecting the monitoring reports impacted by interference.</p>		RF1	RF2	RF3	RX0	-	-	b14:b10	RX1	-	-	b19:b15	RX2	-	b4:b0	b24:b20	RX3	-	b9:b5	b29:b25
	RF1	RF2	RF3																			
RX0	-	-	b14:b10																			
RX1	-	-	b19:b15																			
RX2	-	b4:b0	b24:b20																			
RX3	-	b9:b5	b29:b25																			
TIME_STAMP	4	<p>This field indicates when the last monitoring in the enabled set was performed.</p> <p>1 LSB = 1 millisecond (time stamp rolls over upon exceeding allotted bit width)</p>																				

5.13.27 Sub block 0x1019 – AWR_MONITOR_RX_NOISE_FIGURE_REPORT_AE_SB

This API is a Monitoring Report API which the AWR device sends to the host, containing the measured RX noise figure values corresponding to the full IF band of a profile. The AWR device sends this to host at the programmed periodicity or when failure occurs, as programmed by the configuration API SB.

Table 5.89: AWR_MONITOR_RX_NOISE_FIGURE_REPORT_AE_SB contents

Field Name	Number of bytes	Description																				
SBLKID	2	Value = 0x1019																				
SBLKLEN	2	Value = 52																				
STATUS_FLAGS	2	Status flag indicating pass fail results corresponding to various threshold checks under this monitor. Bit STATUS_FLAG for monitor b0 STATUS_RX_NOISE_FIGURE b15:1 RESERVED 0 – FAIL or check wasn't done 1 – PASS																				
ERROR_CODE	2	Indicates any error reported during monitoring Value of 0 indicates no error																				
PROFILE_INDX	1	Profile Index for which this monitoring report applies.																				
RESERVED	3	0x000000																				
RX_NOISE_FIGURE_VALUE	24	The measured RX input referred for each enabled channel, at each enabled RF frequency is reported here. Byte numbers corresponding to different RX and RF, in this field are here: <table style="margin-left: 40px;"> <tr> <td></td> <td>RF1</td> <td>RF2</td> <td>RF3</td> </tr> <tr> <td>RX0</td> <td>1:0</td> <td>9:8</td> <td>17:16</td> </tr> <tr> <td>RX1</td> <td>3:2</td> <td>11:10</td> <td>19:18</td> </tr> <tr> <td>RX2</td> <td>5:4</td> <td>13:12</td> <td>21:20</td> </tr> <tr> <td>RX3</td> <td>7:6</td> <td>15:14</td> <td>23:22</td> </tr> </table> 1 LSB = 0.1 dB, signed number Only the entries of enabled RF Frequencies and enabled RX channels are valid.		RF1	RF2	RF3	RX0	1:0	9:8	17:16	RX1	3:2	11:10	19:18	RX2	5:4	13:12	21:20	RX3	7:6	15:14	23:22
	RF1	RF2	RF3																			
RX0	1:0	9:8	17:16																			
RX1	3:2	11:10	19:18																			
RX2	5:4	13:12	21:20																			
RX3	7:6	15:14	23:22																			
RESERVED	4	0x00000000																				
RESERVED	4	0x00000000																				
RESERVED	4	0x00000000																				
TIME_STAMP	4	This field indicates when the last monitoring in the enabled set was performed. 1 LSB = 1 millisecond (time stamp rolls over upon exceeding allotted bit width)																				

NOTE: The noise monitor reports the real baseband receivers' noise figure with LNA disabled (to suppress external interference's influence). In complex receiver modes (i.e., complex 1x, complex 2x and pseudo real), the system noise figure is 3dB lower (better) than the reported number.

5.13.28 Sub block 0x101A – AWR_MONITOR_RX_IFSTAGE_REPORT_AE_SB

This API is a Monitoring Report API which the AWR device sends to the host, containing the measured RX IF filter attenuation values at the given IF frequencies. The AWR device sends this to host at the programmed periodicity or when failure occurs, as programmed by the configuration API SB.

Table 5.90: AWR_MONITOR_RX_IFSTAGE_REPORT_AE_SB contents

Field Name	Number of bytes	Description
SBLKID	2	Value = 0x101A
SBLKLEN	2	Value = 48
STATUS_FLAGS	2	Status flag indicating pass fail results corresponding to various threshold checks under this monitor. Bit STATUS_FLAG for monitor b0 STATUS_RX_HPF_ERROR b1 RESERVED b2 STATUS_RX_IFA_GAIN_ERROR b15:3 RESERVED 0 – FAIL or check wasn't done 1 – PASS
ERROR_CODE	2	Indicates any error reported during monitoring Value of 0 indicates no error
PROFILE_INDX	1	Profile Index for which this monitoring report applies.
RESERVED	3	0x000000

Continued on next page

Table 5.90 – continued from previous page

HPF_CUTOFF_FREQ_ERROR_VALUE	8	<p>The deviations of RX IFA HPF cutoff frequency from the ideally expected values for all the enabled RX channels are reported here.</p> <p>HPF_CUTOFF_FREQ_ERROR = $100 \times (\text{Measured Cutoff Frequency} / \text{Expected Cutoff Frequency}) - 100$, for RX IF filter in the HPF region.</p> <p>Byte numbers corresponding to measured cutoff frequency error on different RX channels, in this field are here:</p> <table data-bbox="662 683 1045 884"> <thead> <tr> <th></th> <th>I channel</th> <th>Q channel</th> </tr> </thead> <tbody> <tr> <td>RX0</td> <td>0</td> <td>4</td> </tr> <tr> <td>RX1</td> <td>1</td> <td>5</td> </tr> <tr> <td>RX2</td> <td>2</td> <td>6</td> </tr> <tr> <td>RX3</td> <td>3</td> <td>7</td> </tr> </tbody> </table> <p>1 LSB = 1%, signed number Applicable only for the enabled channels.</p>		I channel	Q channel	RX0	0	4	RX1	1	5	RX2	2	6	RX3	3	7
	I channel	Q channel															
RX0	0	4															
RX1	1	5															
RX2	2	6															
RX3	3	7															
LPF_CUTOFF_FREQ_ERROR_VALUE	8	<p>NOTE: This field is not applicable in this release for all devices. This is a RESERVED field and will be set to 0.</p> <p>The deviations of RX IFA LPF cutoff frequency from the ideally expected values for all the enabled RX channels are reported here.</p> <p>LPF_CUTOFF_FREQ_ERROR = $100 \times (\text{Measured Cutoff Frequency} / \text{Expected Cutoff Frequency}) - 100$, for RX IF filter in the LPF region.</p> <p>Byte numbers corresponding to measured cutoff frequency error on different RX channels, in this field are here:</p> <table data-bbox="662 1366 1045 1568"> <thead> <tr> <th></th> <th>I channel</th> <th>Q channel</th> </tr> </thead> <tbody> <tr> <td>RX0</td> <td>0</td> <td>4</td> </tr> <tr> <td>RX1</td> <td>1</td> <td>5</td> </tr> <tr> <td>RX2</td> <td>2</td> <td>6</td> </tr> <tr> <td>RX3</td> <td>3</td> <td>7</td> </tr> </tbody> </table> <p>1 LSB = 1%, signed number Applicable only for the enabled channels.</p>		I channel	Q channel	RX0	0	4	RX1	1	5	RX2	2	6	RX3	3	7
	I channel	Q channel															
RX0	0	4															
RX1	1	5															
RX2	2	6															
RX3	3	7															

Continued on next page

Table 5.90 – continued from previous page

RX_IFA_GAIN_ERROR_VALUE	8	<p>The deviations of RX IFA Gain from the ideally expected values for all the enabled RX channels are reported here.</p> <p>Byte numbers corresponding to measured cutoff frequency error on different RX channels and HPF/LPF, in this field are here:</p> <table border="1"> <thead> <tr> <th></th> <th>I channel</th> <th>Q channel</th> </tr> </thead> <tbody> <tr> <td>RX0</td> <td>0</td> <td>4</td> </tr> <tr> <td>RX1</td> <td>1</td> <td>5</td> </tr> <tr> <td>RX2</td> <td>2</td> <td>6</td> </tr> <tr> <td>RX3</td> <td>3</td> <td>7</td> </tr> </tbody> </table> <p>1 LSB = 0.1 dB, signed number Applicable only for the enabled channels.</p>		I channel	Q channel	RX0	0	4	RX1	1	5	RX2	2	6	RX3	3	7
	I channel	Q channel															
RX0	0	4															
RX1	1	5															
RX2	2	6															
RX3	3	7															
IFA_GAIN_EXP	1	Expected IFA gain 1 LSB = 1 dB															
RESERVED	3	0x000000															
RESERVED	4	0x00000000															
TIME_STAMP	4	<p>This field indicates when the last monitoring in the enabled set was performed.</p> <p>1 LSB = 1 millisecond (time stamp rolls over upon exceeding allotted bit width)</p>															

5.13.29 Sub block 0x101B – AWR_MONITOR_TX0_POWER_REPORT_AE_SB

NOTE: The TX[0:2] power monitoring accuracy degrades at high TX backoffs and is unreliable for backoffs higher than 20dB.

This API is a Monitoring Report API which the AWR device sends to the host, containing the measured TX power values during an explicit monitoring chirp. The AWR device sends this to host at the programmed periodicity or when failure occurs, as programmed by the configuration API SB.

Table 5.91: AWR_MONITOR_TX0_POWER_REPORT_AE_SB contents

Field Name	Number of bytes	Description
SBLKID	2	Value = 0x101B
SBLKLEN	2	Value = 24

Continued on next page

Table 5.91 – continued from previous page

STATUS_FLAGS	2	<p>Status flag indicating pass fail results corresponding to various threshold checks under this monitor.</p> <p>Bit STATUS_FLAG for monitor</p> <p>b0 STATUS_ABS_ERR</p> <p>b1 STATUS_FLATNESS_ERR</p> <p>b15:2 RESERVED</p> <p>0 – FAIL or check wasn't done</p> <p>1 – PASS</p>								
ERROR_CODE	2	<p>Indicates any error reported during monitoring</p> <p>Value of 0 indicates no error</p>								
PROFILE_INDX	1	<p>Profile Index for which this monitoring report applies</p>								
RESERVED	3	<p>0x000000</p>								
TX_POWER_VALUE	6	<p>The measured TX power for each enabled channel, at each enabled RF frequency is reported here.</p> <p>Byte numbers corresponding to different TX and RF, in this field are here:</p> <table style="margin-left: 40px;"> <tr> <td></td> <td>RF1</td> <td>RF2</td> <td>RF3</td> </tr> <tr> <td>TX0</td> <td>1:0</td> <td>3:2</td> <td>5:4</td> </tr> </table> <p>(other bytes are reserved)</p> <p>1 LSB = 0.1 dBm, signed number</p> <p>Only the entries of enabled RF Frequencies and enabled RX channels are valid.</p>		RF1	RF2	RF3	TX0	1:0	3:2	5:4
	RF1	RF2	RF3							
TX0	1:0	3:2	5:4							
RESERVED	2	<p>0x0000</p>								
TIME_STAMP	4	<p>This field indicates when the last monitoring in the enabled set was performed.</p> <p>1 LSB = 1 millisecond (time stamp rolls over upon exceeding allotted bit width)</p>								

5.13.30 Sub block 0x101C – AWR_MONITOR_TX1_POWER_REPORT_AE_SB

This API is a Monitoring Report API which the AWR device sends to the host, containing the measured TX power values during an explicit monitoring chirp. The AWR device sends this to host at the programmed periodicity or when failure occurs, as programmed by the configuration API SB.

Table 5.92: AWR_MONITOR_TX1_POWER_REPORT_AE_SB contents

Field Name	Number of bytes	Description
SBLKID	2	Value = 0x101C
SBLKLEN	2	Value = 24
STATUS_FLAGS	2	Status flag indicating pass fail results corresponding to various threshold checks under this monitor. Bit STATUS_FLAG for monitor b0 STATUS_ABS_ERR b1 STATUS_FLATNESS_ERR b15:2 RESERVED 0 – FAIL or check wasn't done 1 – PASS
ERROR_CODE	2	Indicates any error reported during monitoring Value of 0 indicates no error
PROFILE_INDX	1	Profile Index for which this monitoring report applies
RESERVED	3	0x000000
TX_POWER_VALUE	6	The measured TX power for each enabled channel, at each enabled RF frequency is reported here. Byte numbers corresponding to different TX and RF, in this field are here: RF1 RF2 RF3 TX1 1:0 3:2 5:4 (other bytes are reserved) 1 LSB = 0.1 dBm, signed number Only the entries of enabled RF Frequencies and enabled RX channels are valid.
RESERVED	2	0x0000
TIME_STAMP	4	This field indicates when the last monitoring in the enabled set was performed. 1 LSB = 1 millisecond (time stamp rolls over upon exceeding allotted bit width)

5.13.31 Sub block 0x101D – AWR_MONITOR_TX2_POWER_REPORT_AE_SB

This API is a Monitoring Report API which the AWR device sends to the host, containing the measured TX power values during an explicit monitoring chirp. The AWR device sends this to host at the programmed periodicity or when failure occurs, as programmed by the configuration API SB.

Table 5.93: AWR_MONITOR_TX2_POWER_REPORT_AE_SB contents

Field Name	Number of bytes	Description
SBLKID	2	Value = 0x101D
SBLKLEN	2	Value = 24
STATUS_FLAGS	2	Status flag indicating pass fail results corresponding to various threshold checks under this monitor. Bit STATUS_FLAG for monitor b0 STATUS_ABS_ERR b1 STATUS_FLATNESS_ERR b15:2 RESERVED 0 – FAIL or check wasn't done 1 – PASS
ERROR_CODE	2	Indicates any error reported during monitoring Value of 0 indicates no error
PROFILE_INDX	1	Profile Index for which this monitoring report applies
RESERVED	3	0x000000
TX_POWER_VALUE	6	The measured TX power for each enabled channel, at each enabled RF frequency is reported here. Byte numbers corresponding to different TX and RF, in this field are here: RF1 RF2 RF3 TX2 1:0 3:2 5:4 (other bytes are reserved) 1 LSB = 0.1 dBm, signed number Only the entries of enabled RF Frequencies and enabled RX channels are valid.
RESERVED	2	0x0000
TIME_STAMP	4	This field indicates when the last monitoring in the enabled set was performed. 1 LSB = 1 millisecond (time stamp rolls over upon exceeding allotted bit width)

5.13.32 Sub block 0x101E – AWR_MONITOR_TX0_BALLBREAK_REPORT_AE_SB

This API is a Monitoring Report API which the AWR device sends to the host, containing the measured TX reflection coefficient's magnitude values, meant for detecting TX ball break. The AWR device sends this to host at the programmed periodicity or when failure occurs, as programmed by the configuration API SB.

Table 5.94: AWR_MONITOR_TX0_BALLBREAK_REPORT_AE_SB contents

Field Name	Number of bytes	Description
SBLKID	2	Value = 0x101E
SBLKLEN	2	Value = 20
STATUS_FLAGS	2	Status flag indicating pass fail results corresponding to various threshold checks under this monitor. Bit STATUS_FLAG for monitor b0 STATUS_TX0_BALLBREAK b15:1 RESERVED 0 – FAIL or check wasn't done 1 – PASS
ERROR_CODE	2	Indicates any error reported during monitoring Value of 0 indicates no error
TX_REFL_COEFF_VALUE	2	The TX reflection coefficient's magnitude for this channel is reported here. 1 LSB = 0.1 dB, signed number
RESERVED	2	0x0000
RESERVED	4	0x00000000
TIME_STAMP	4	This field indicates when the last monitoring in the enabled set was performed. 1 LSB = 1 millisecond (time stamp rolls over upon exceeding allotted bit width)

5.13.33 Sub block 0x101F – AWR_MONITOR_TX1_BALLBREAK_REPORT_AE_SB

This API is a Monitoring Report API which the AWR device sends to the host, containing the measured TX reflection coefficient's magnitude values, meant for detecting TX ball break. The AWR device sends this to host at the programmed periodicity or when failure occurs, as programmed by the configuration API SB.

Table 5.95: AWR_MONITOR_TX1_BALLBREAK_REPORT_AE_SB contents

Field Name	Number of bytes	Description
SBLKID	2	Value = 0x101F
SBLKLEN	2	Value = 20

Continued on next page

Table 5.95 – continued from previous page

STATUS_FLAGS	2	Status flag indicating pass fail results corresponding to various threshold checks under this monitor. Bit STATUS_FLAG for monitor b0 STATUS_TX0_BALLBREAK b15:1 RESERVED 0 – FAIL or check wasn't done 1 – PASS
ERROR_CODE	2	Indicates any error reported during monitoring Value of 0 indicates no error
TX_REFL_COEFF_VALUE	2	The TX reflection coefficient's magnitude for this channel is reported here. 1 LSB = 0.1 dB, signed number
RESERVED	2	0x0000
RESERVED	4	0x00000000
TIME_STAMP	4	This field indicates when the last monitoring in the enabled set was performed. 1 LSB = 1 millisecond (time stamp rolls over upon exceeding allotted bit width)

5.14 Sub blocks related to AWR_RF_ASYNC_EVENT_MSG2

5.14.1 Sub block 0x1020 – AWR_MONITOR_TX2_BALLBREAK_REPORT_AE_SB

This API is a Monitoring Report API which the AWR device sends to the host, containing the measured TX reflection coefficient's magnitude values, meant for detecting TX ball break. The AWR device sends this to host at the programmed periodicity or when failure occurs, as programmed by the configuration API SB.

Table 5.96: AWR_MONITOR_TX2_BALLBREAK_REPORT_AE_SB contents

Field Name	Number of bytes	Description
SBLKID	2	Value = 0x1020
SBLKLEN	2	Value = 20

Continued on next page

Table 5.96 – continued from previous page

STATUS_FLAGS	2	Status flag indicating pass fail results corresponding to various threshold checks under this monitor. Bit STATUS_FLAG for monitor b0 STATUS_TX0_BALLBREAK b15:1 RESERVED 0 – FAIL or check wasn't done 1 – PASS
ERROR_CODE	2	Indicates any error reported during monitoring Value of 0 indicates no error
TX_REFL_CO-EFF_VALUE	2	The TX reflection coefficient's magnitude for this channel is reported here. 1 LSB = 0.1 dB, signed number
RESERVED	2	0x0000
RESERVED	4	0x00000000
TIME_STAMP	4	This field indicates when the last monitoring in the enabled set was performed. 1 LSB = 1 millisecond (time stamp rolls over upon exceeding allotted bit width)

5.14.2 Sub block 0x1021 – AWR_MONITOR_TX_GAIN_PHASE_MISMATCH_REPORT_AE_SB

This API is a Monitoring Report API which the AWR device sends to the host, containing the measured TX gain and phase mismatch values during an explicit monitoring chirp. The AWR device sends this to host at the programmed periodicity or when failure occurs, as programmed by the configuration API SB.

Table 5.97: AWR_MONITOR_TX_GAIN_PHASE_REPORT_AE_SB contents

Field Name	Number of bytes	Description
SBLKID	2	Value = 0x1021
SBLKLEN	2	Value = 60

Continued on next page

Table 5.97 – continued from previous page

STATUS_FLAGS	2	<p>Status flag indicating pass fail results corresponding to various threshold checks under this monitor.</p> <p>Bit STATUS_FLAG for monitor</p> <p>b0 STATUS_TX_GAIN_MISMATCH</p> <p>b1 STATUS_TX_PHASE_MISMATCH</p> <p>b15:2 RESERVED</p> <p>0 – FAIL or check wasn't done</p> <p>1 – PASS</p>																
ERROR_CODE	2	<p>Indicates any error reported during monitoring</p> <p>Value of 0 indicates no error</p>																
PROFILE_INDX	1	<p>Profile Index for which this monitoring report applies</p>																
RESERVED	3	<p>0x000000</p>																
TX_GAIN_VALUE	18	<p>The measured TX PA loopback tone power at the RX ADC input, for each enabled TX channel, at each enabled RF frequency is reported here.</p> <p>Byte numbers corresponding to different TX and RF, in this field are here:</p> <table border="1"> <thead> <tr> <th></th> <th>RF1</th> <th>RF2</th> <th>RF3</th> </tr> </thead> <tbody> <tr> <td>TX0</td> <td>1:0</td> <td>7:6</td> <td>13:12</td> </tr> <tr> <td>TX1</td> <td>3:2</td> <td>9:8</td> <td>15:14</td> </tr> <tr> <td>TX2</td> <td>5:4</td> <td>11:10</td> <td>17:16</td> </tr> </tbody> </table> <p>1 LSB = 0.1dBm, signed number</p> <p>Only the entries of enabled RF Frequencies and enabled TX channels are valid.</p>		RF1	RF2	RF3	TX0	1:0	7:6	13:12	TX1	3:2	9:8	15:14	TX2	5:4	11:10	17:16
	RF1	RF2	RF3															
TX0	1:0	7:6	13:12															
TX1	3:2	9:8	15:14															
TX2	5:4	11:10	17:16															
TX_PHASE_VALUE	18	<p>The measured TX phase for each enabled channel, at each enabled RF frequency is reported here.</p> <p>Byte numbers corresponding to different TX and RF, in this field are here:</p> <table border="1"> <thead> <tr> <th></th> <th>RF1</th> <th>RF2</th> <th>RF3</th> </tr> </thead> <tbody> <tr> <td>TX0</td> <td>1:0</td> <td>7:6</td> <td>13:12</td> </tr> <tr> <td>TX1</td> <td>3:2</td> <td>9:8</td> <td>15:14</td> </tr> <tr> <td>TX2</td> <td>5:4</td> <td>11:10</td> <td>17:16</td> </tr> </tbody> </table> <p>1 LSB = $360^\circ / 2^{16}$</p> <p>Only the entries of enabled RF Frequencies and enabled TX channels are valid.</p> <p>NOTE: these phases include an unknown bias common to all TX channels.</p>		RF1	RF2	RF3	TX0	1:0	7:6	13:12	TX1	3:2	9:8	15:14	TX2	5:4	11:10	17:16
	RF1	RF2	RF3															
TX0	1:0	7:6	13:12															
TX1	3:2	9:8	15:14															
TX2	5:4	11:10	17:16															
RESERVED	4	<p>0x00000000</p>																

Continued on next page

Table 5.97 – continued from previous page

RESERVED	4	0x00000000
TIMESTAMP	4	This field indicates when the last monitoring in the enabled set was performed. 1 LSB = 1 millisecond (time stamp rolls over upon exceeding allotted bit width)

5.14.3 Sub block 0x1022 – AWR_MONITOR_TX0_BPM_REPORT_AE_SB

This API is a Monitoring Report API which the AWR device sends to the host, containing the measured TX0 BPM error values. The AWR device sends this to host at the programmed periodicity or when failure occurs, as programmed by the configuration API SB.

Table 5.98: AWR_MONITOR_TX0_BPM_REPORT_AE_SB contents

Field Name	Number of bytes	Description
SBLKID	2	Value = 0x1022
SBLKLEN	2	Value = 20
STATUS_FLAGS	2	Status flag indicating pass fail results corresponding to various threshold checks under this monitor. Bit STATUS_FLAG for monitor b0 STATUS_TX0_BPM_PHASE b1 STATUS_TX0_BPM_AMPLITUDE b2 RESERVED b15:3 RESERVED 0 – FAIL or check wasn't done 1 – PASS
ERROR_CODE	2	Indicates any error reported during monitoring Value of 0 indicates no error
PROFILE_INDX	1	Profile Index for which this monitoring report applies
PH_SHIFTER_MON_VAL2_MSB	1	MSB of the monitored phase shift for PH_SHIFTER_MON2 for TX0 When combined with PH_SHIFTER_MON_VAL2_LSB, this represents the phase shift value in 16 bits. PH_SHIFTER_MON_VAL2 = PH_SHIFTER_MON_VAL2_MSB $\times 2^8$ + PH_SHIFTER_MON_VAL2_LSB
PH_SHIFTER_MON_VAL1	2	Monitored phase shift for PH_SHIFTER_MON1 for TX0 1 LSB = $360^\circ / 2^{16}$

Continued on next page

Table 5.98 – continued from previous page

TX_BPM_PHASE_DIFF_VALUE	2	The TX output phase difference between the two BPM settings (phase for TX BPM setting 0 – phase for TX BPM setting 1) is reported here. 1 LSB = $360^\circ / 2^{16}$
TX_BPM_AMPLITUDE_DIFF_VALUE	1	The deviation of the TX output amplitude difference between the two BPM settings (amplitude for TX BPM setting 0 – amplitude for TX BPM setting 1) from the ideal 0dB is reported here. 1 LSB = 0.1 dB, signed number
PH_SHIFTER_MON_VAL2_LSB	1	LSB of the monitored phase shift for PH_SHIFTER_MON2 for TX0 When combined with PH_SHIFTER_MON_VAL2_MSB, this represents the phase shift value in 16 bits. $PH_SHIFTER_MON_VAL2 = PH_SHIFTER_MON_VAL2_MSB \times 2^8 + PH_SHIFTER_MON_VAL2_LSB$ 1 LSB = $360^\circ / 2^{16}$
TIME_STAMP	4	This field indicates when the last monitoring in the enabled set was performed. 1 LSB = 1 millisecond (time stamp rolls over upon exceeding allotted bit width)

5.14.4 Sub block 0x1023 – AWR_MONITOR_TX1_BPM_REPORT_AE_SB

This API is a Monitoring Report API which the AWR device sends to the host, containing the measured TX1 BPM error values. The AWR device sends this to host at the programmed periodicity or when failure occurs, as programmed by the configuration API SB.

Table 5.99: AWR_MONITOR_TX1_BPM_REPORT_AE_SB contents

Field Name	Number of bytes	Description
SBLKID	2	Value = 0x1023
SBLKLEN	2	Value = 20

Continued on next page

Table 5.99 – continued from previous page

STATUS_FLAGS	2	<p>Status flag indicating pass fail results corresponding to various threshold checks under this monitor.</p> <p>Bit STATUS_FLAG for monitor</p> <p>b0 STATUS_TX1_BPM_PHASE</p> <p>b1 STATUS_TX1_BPM_AMPLITUDE</p> <p>b2 RESERVED</p> <p>b15:3 RESERVED</p> <p>0 – FAIL or check wasn't done</p> <p>1 – PASS</p>
ERROR_CODE	2	<p>Indicates any error reported during monitoring</p> <p>Value of 0 indicates no error</p>
PROFILE_INDX	1	<p>Profile Index for which this monitoring report applies</p>
PH_SHIFTER_MON_VAL2_MSB	1	<p>MSB of the monitored phase shift for PH_SHIFTER_MON2 for TX1</p> <p>When combined with PH_SHIFTER_MON_VAL2_LSB, this represents the phase shift value in 16 bits.</p> <p>$PH_SHIFTER_MON_VAL2 = PH_SHIFTER_MON_VAL2_MSB \times 2^8 + PH_SHIFTER_MON_VAL2_LSB$</p>
PH_SHIFTER_MON_VAL1	2	<p>Monitored phase shift for PH_SHIFTER_MON1 for TX1</p> <p>1 LSB = $360^\circ / 2^{16}$</p>
TX_BPM_PHASE_DIFF_VALUE	2	<p>The TX output phase difference between the two BPM settings (phase for TX BPM setting 0 – phase for TX BPM setting 1) is reported here.</p> <p>1 LSB = $360^\circ / 2^{16}$</p>
TX_BPM_AMPLITUDE_DIFF_VALUE	1	<p>The deviation of the TX output amplitude difference between the two BPM settings (amplitude for TX BPM setting 0 – amplitude for TX BPM setting 1) from the ideal 0dB is reported here.</p> <p>1 LSB = 0.1 dB, signed number</p>
PH_SHIFTER_MON_VAL2_LSB	1	<p>LSB of the monitored phase shift for PH_SHIFTER_MON2 for TX0</p> <p>When combined with PH_SHIFTER_MON_VAL2_MSB, this represents the phase shift value in 16 bits.</p> <p>$PH_SHIFTER_MON_VAL2 = PH_SHIFTER_MON_VAL2_MSB \times 2^8 + PH_SHIFTER_MON_VAL2_LSB$</p> <p>1 LSB = $360^\circ / 2^{16}$</p>
TIME_STAMP	4	<p>This field indicates when the last monitoring in the enabled set was performed.</p> <p>1 LSB = 1 millisecond (time stamp rolls over upon exceeding allotted bit width)</p>

5.14.5 Sub block 0x1024 – AWR_MONITOR_TX2_BPM_REPORT_AE_SB

This API is a Monitoring Report API which the AWR device sends to the host, containing the measured TX2 BPM error values. The AWR device sends this to host at the programmed periodicity or when failure occurs, as programmed by the configuration API SB.

Table 5.100: AWR_MONITOR_TX2_BPM_REPORT_AE_SB contents

Field Name	Number of bytes	Description
SBLKID	2	Value = 0x1024
SBLKLEN	2	Value = 20
STATUS_FLAGS	2	Status flag indicating pass fail results corresponding to various threshold checks under this monitor. Bit STATUS_FLAG for monitor b0 STATUS_TX2_BPM_PHASE b1 STATUS_TX2_BPM_AMPLITUDE b2 RESERVED b15:3 RESERVED 0 – FAIL or check wasn't done 1 – PASS
ERROR_CODE	2	Indicates any error reported during monitoring Value of 0 indicates no error
PROFILE_INDX	1	Profile Index for which this monitoring report applies
PH_SHIFTER_MON_VAL2_MSB	1	MSB of the monitored phase shift for PH_SHIFTER_MON2 for TX2 When combined with PH_SHIFTER_MON_VAL2_LSB, this represents the phase shift value in 16 bits. PH_SHIFTER_MON_VAL2 = PH_SHIFTER_MON_VAL2_MSB $\times 2^8$ + PH_SHIFTER_MON_VAL2_LSB
PH_SHIFTER_MON_VAL1	2	Monitored phase shift for PH_SHIFTER_MON1 for TX2 1 LSB = $360^\circ / 2^{16}$
TX_BPM_PHASE_DIFF_VALUE	2	The TX output phase difference between the two BPM settings (phase for TX BPM setting 0 – phase for TX BPM setting 1) is reported here. 1 LSB = $360^\circ / 2^{16}$
TX_BPM_AMPLITUDE_DIFF_VALUE	1	The deviation of the TX output amplitude difference between the two BPM settings (amplitude for TX BPM setting 0 – amplitude for TX BPM setting 1) from the ideal 0dB is reported here. 1 LSB = 0.1 dB, signed number

Continued on next page

Table 5.100 – continued from previous page

PH_SHIFTER_MON_VAL2_LSB	1	LSB of the monitored phase shift for PH_SHIFTER_MON2 for TX0 When combined with PH_SHIFTER_MON_VAL2_MSB, this represents the phase shift value in 16 bits. $PH_SHIFTER_MON_VAL2 = PH_SHIFTER_MON_VAL2_MSB \times 2^8 + PH_SHIFTER_MON_VAL2_LSB$ $1\text{ LSB} = 360^\circ / 2^{16}$
TIME_STAMP	4	This field indicates when the last monitoring in the enabled set was performed. $1\text{ LSB} = 1\text{ millisecond}$ (time stamp rolls over upon exceeding allotted bit width)

5.14.6 Sub block 0x1025 – AWR_MONITOR_SYNTHESIZER_FREQUENCY_REPORT_AE_SB

This API is a Monitoring Report API which the AWR device sends to the host, containing information related to measured frequency error during the chirp. The AWR device sends this to host at the programmed periodicity or when failure occurs, as programmed by the configuration API SB.

Table 5.101: AWR_MONITOR_SYNTH_FREQUENCY_REPORT_AE_SB contents

Field Name	Number of bytes	Description
SBLKID	2	Value = 0x1025
SBLKLEN	2	Value = 32
STATUS_FLAGS	2	Status flag indicating pass fail results corresponding to various threshold checks under this monitor. Bit STATUS_FLAG for monitor b0 STATUS_SYNTH_FREQ_ERR b15:1 RESERVED 0 – FAIL or check wasn't done 1 – PASS
ERROR_CODE	2	Indicates any error reported during monitoring Value of 0 indicates no error
PROFILE_INDX	1	Profile Index for which this monitoring report applies
RESERVED	3	0x000000

Continued on next page

Table 5.101 – continued from previous page

MAX_FREQUENCY_ERROR_VALUE	4	This field indicates the maximum instantaneous frequency error measured during the chirps for which frequency monitoring has been enabled in the previous monitoring period. Bits Parameter b31:0 Maximum frequency error value, signed number. 1 LSB = 1 kHz.
FREQUENCY_FAILURE_COUNT	4	This field indicates the number of times during chirping in the previous monitoring period in which the measured frequency error violated the allowed threshold. Frequency error threshold violation is counted every 10 ns. Bits Parameter b31:19 RESERVED b18:0 Failure count, unsigned number
RESERVED	4	0x00000000
RESERVED	4	0x00000000
TIME_STAMP	4	This field indicates when the last monitoring in the enabled set was performed. 1 LSB = 1 millisecond (time stamp rolls over upon exceeding allotted bit width)

5.14.7 Sub block 0x1026 – AWR_MONITOR_EXTERNAL_ANALOG_SIGNALS_REPORT_AE_SB

This API is a Monitoring Report API which the AWR device sends to the host, containing the external signal voltage values measured using the GPADC. The AWR device sends this to host at the programmed periodicity or when failure occurs, as programmed by the configuration API SB.

Table 5.102: AWR_MONITOR_EXTERNAL_ANALOG_SIGNALS_REPORT_AE_SB contents

Field Name	Number of bytes	Description
SBLKID	2	Value = 0x1026
SBLKLEN	2	Value = 28

Continued on next page

Table 5.102 – continued from previous page

STATUS_FLAGS	2	Status flags indicating pass fail results corresponding to various threshold checks under this monitor. Bit Definition b0 STATUS_ANALOGTEST1 b1 STATUS_ANALOGTEST2 b2 STATUS_ANALOGTEST3 b3 STATUS_ANALOGTEST4 b4 STATUS_ANAMUX b5 STATUS_VSENSE b15:6 RESERVED 0 – FAIL or check wasn't done 1 – PASS
ERROR_CODE	2	Indicates any error reported during monitoring Value of 0 indicates no error
EXTERNAL_ANALOG_SIGNAL_VALUES	12	MEASURED_VALUE Bytes SIGNAL 1:0 ANALOGTEST1 3:2 ANALOGTEST2 5:4 ANALOGTEST3 7:6 ANALOGTEST4 9:8 ANAMUX 11:10 VSENSE 1 LSB = 1.8V/1024
RESERVED	4	0x00000000
TIME_STAMP	4	This field indicates when the last monitoring in the enabled set was performed. 1 LSB = 1 millisecond (time stamp rolls over upon exceeding allotted bit width)

5.14.8 Sub block 0x1027 – AWR_MONITOR_TX0_INTERNAL_ANALOG_SIGNALS_REPORT_AE_SB

This API is a Monitoring Report API which the AWR device sends to the host, containing information about Internal TX0 internal analog signals including Tx Phase shifter DAC monitor report (This is a new feature addition in **xWR6843** and **xWR1843** only). The AWR device sends this to host at the programmed periodicity or when failure occurs, as programmed by the configuration API SB.

Table 5.103: AWR_MONITOR_TX0_INTERNAL_ANALOG_SIGNALS_REPORT_AE_SB contents

Field Name	Number of bytes	Description
SBLKID	2	Value = 0x1027
SBLKLEN	2	Value = 16
STATUS_FLAGS	2	Status flag indicating pass fail results corresponding to various threshold checks under this monitor. Bit STATUS_FLAG for monitor b0 STATUS_SUPPLY_TX0 b1 STATUS_DCBIAS_TX0 b2 STATUS_PS_DAC_TX0 b15:3 RESERVED 0 – FAIL or check wasn't done 1 – PASS
ERROR_CODE	2	Indicates any error reported during monitoring Value of 0 indicates no error
PROFILE_INDX	1	Profile Index for which this monitoring report applies
RESERVED	1	0x00
PS_DAC_IDELTA_MIN	1	Phase shifter DAC I arm delta min value across different DAC settings Unit: 1 LSB = 1.8V/1024 NOTE: This field is applicable only for xWR6843 and xWR1843 devices only
PS_DAC_QDELTA_MIN	1	Phase shifter DAC Q arm delta min value across different DAC settings Unit: 1 LSB = 1.8V/1024 NOTE: This field is applicable only for xWR6843 and xWR1843 devices only
TIME_STAMP	4	This field indicates when the last monitoring in the enabled set was performed. 1 LSB = 1 millisecond (time stamp rolls over upon exceeding allotted bit width)

5.14.9 Sub block 0x1028 – AWR_MONITOR_TX1_INTERNAL_ANALOG_SIGNALS_REPORT_AE_SB

This API is a Monitoring Report API which the AWR device sends to the host, containing information about Internal TX1 internal analog signals including Tx Phase shifter DAC monitor report (This is a new feature addition in **xWR6843** and **xWR1843** only). The AWR device sends this to

host at the programmed periodicity or when failure occurs, as programmed by the configuration API SB.

Table 5.104: AWR_MONITOR_TX1_INTERNAL_ANALOG_SIGNALS_REPORT_AE_SB contents

Field Name	Number of bytes	Description
SBLKID	2	Value = 0x1028
SBLKLEN	2	Value = 16
STATUS_FLAGS	2	Status flag indicating pass fail results corresponding to various threshold checks under this monitor. Bit STATUS_FLAG for monitor b0 STATUS_SUPPLY_TX1 b1 STATUS_DCBIAS_TX1 b2 STATUS_PS_DAC_TX1 b15:3 RESERVED 0 – FAIL or check wasn't done 1 – PASS
ERROR_CODE	2	Indicates any error reported during monitoring Value of 0 indicates no error
PROFILE_INDX	1	Profile Index for which this monitoring report applies
RESERVED	1	0x00
PS_DAC_IDELTA_MIN	1	Phase shifter DAC I arm delta min value across different DAC settings Unit: 1 LSB = 1.8V/1024 NOTE: This field is applicable only for xWR6843 and xWR1843 devices only
PS_DAC_QDELTA_MIN	1	Phase shifter DAC Q arm delta min value across different DAC settings Unit: 1 LSB = 1.8V/1024 NOTE: This field is applicable only for xWR6843 and xWR1843 devices only
TIME_STAMP	4	This field indicates when the last monitoring in the enabled set was performed. 1 LSB = 1 millisecond (time stamp rolls over upon exceeding allotted bit width)

5.14.10 Sub block 0x1029 – AWR_MONITOR_TX2_INTERNAL_ANALOG_SIGNALS_REPORT_AE_SB

This API is a Monitoring Report API which the AWR device sends to the host, containing information about Internal TX2 internal analog signals including Tx Phase shifter DAC monitor report (This is a new feature addition in **xWR6843** and **xWR1843** only). The AWR device sends this to host at the programmed periodicity or when failure occurs, as programmed by the configuration API SB.

Table 5.105: AWR_MONITOR_TX2_INTERNAL_ANALOG_SIGNALS_REPORT_AE_SB contents

Field Name	Number of bytes	Description
SBLKID	2	Value = 0x1029
SBLKLEN	2	Value = 16
STATUS_FLAGS	2	Status flag indicating pass fail results corresponding to various threshold checks under this monitor. Bit STATUS_FLAG for monitor b0 STATUS_SUPPLY_TX2 b1 STATUS_DCBIAS_TX2 b2 STATUS_PS_DAC_TX2 b15:3 RESERVED 0 – FAIL or check wasn't done 1 – PASS
ERROR_CODE	2	Indicates any error reported during monitoring Value of 0 indicates no error
PROFILE_INDX	1	Profile Index for which this monitoring report applies
RESERVED	1	0x00
PS_DAC_IDELTA_MIN	1	Phase shifter DAC I arm delta min value across different DAC settings Unit: 1 LSB = 1.8V/1024 NOTE: This field is applicable only for xWR6843 and xWR1843 devices only
PS_DAC_QDELTA_MIN	1	Phase shifter DAC Q arm delta min value across different DAC settings Unit: 1 LSB = 1.8V/1024 NOTE: This field is applicable only for xWR6843 and xWR1843 devices only
TIME_STAMP	4	This field indicates when the last monitoring in the enabled set was performed. 1 LSB = 1 millisecond (time stamp rolls over upon exceeding allotted bit width)

5.14.11 Sub block 0x102A – AWR_MONITOR_RX_INTERNAL_ANALOG_SIGNALS_REPORT_AE_SB

This API is a Monitoring Report API which the AWR device sends to the host, containing information about Internal RX internal analog signals. The AWR device sends this to host at the programmed periodicity or when failure occurs, as programmed by the configuration API SB.

Table 5.106: AWR_MONITOR_RX_INTERNAL_ANALOG_SIGNALS_REPORT_AE_SB contents

Field Name	Number of bytes	Description
SBLKID	2	Value = 0x102A
SBLKLEN	2	Value = 16
STATUS_FLAGS	2	Status flags indicating pass fail results corresponding to various threshold checks under this monitor. Bit STATUS_FLAG for monitor b0 STATUS_SUPPLY_RX0 b1 STATUS_SUPPLY_RX1 b2 STATUS_SUPPLY_RX2 b3 STATUS_SUPPLY_RX3 b4 STATUS_DCBIAS_RX0 b5 STATUS_DCBIAS_RX1 b6 STATUS_DCBIAS_RX2 b7 STATUS_DCBIAS_RX3 b15:8 RESERVED 0 – FAIL or check wasn't done 1 – PASS
ERROR_CODE	2	Indicates any error reported during monitoring Value of 0 indicates no error
PROFILE_INDX	1	Profile Index for which this monitoring report applies
RESERVED	3	0x000000
TIME_STAMP	4	This field indicates when the last monitoring in the enabled set was performed. 1 LSB = 1 millisecond (time stamp rolls over upon exceeding allotted bit width)

5.14.12 Sub block 0x102B – AWR_MONITOR_PMCLKLO_INTERNAL_ANALOG_SIGNALS_REPORT_AE_SB

This API is a Monitoring Report API which the AWR device sends to the host, containing information about Internal PM, CLK and LO subsystems' internal analog signals. The AWR device sends this to host at the programmed periodicity or when failure occurs, as programmed by the configuration API SB.

Table 5.107: AWR_MONITOR_PM_CLK_LO_INTERNAL_ANALOG_SIGNALS_REPORT_AE_SB contents

Field Name	Number of bytes	Description
SBLKID	2	Value = 0x102B
SBLKLEN	2	Value = 16
STATUS_FLAGS	2	Status flags indicating pass fail results corresponding to various threshold checks under this monitor. Bit STATUS_FLAG for monitor b0 STATUS_SUPPLY_PMCLKLO b1 STATUS_DCBIAS_PMCLKLO b2 STATUS_LVDS_PMCLKLO (Use this status bit only if LVDS is used, else ignore this) b3 RESERVED b15:4 RESERVED 0 – FAIL or check wasn't done 1 – PASS
ERROR_CODE	2	Indicates any error reported during monitoring Value of 0 indicates no error
PROFILE_INDX	1	Profile Index for which this monitoring report applies
SYNC_20G_POWER	1	Monitored 20 GHz signal power, signed number Unit: 1 LSB = 0.5 dBm The 20GHz SYNC monitor is done at 77GHz RF frequency.
RESERVED	2	0x000000
TIME_STAMP	4	This field indicates when the last monitoring in the enabled set was performed. 1 LSB = 1 millisecond (time stamp rolls over upon exceeding allotted bit width)

5.14.13 Sub block 0x102C – AWR_MONITOR_GPADC_INTERNAL_ANALOG_SIGNALS_REPORT_AE_SB

This API is a Monitoring Report API which the AWR device sends to the host, containing information about the measured value of the GPADC input DC signals whose measurements were enabled. The AWR device sends this to host at the programmed periodicity or when failure occurs, as programmed by the configuration API SB.

Table 5.108: AWR_MONITOR_GPADC_INTERNAL_ANALOG_SIGNALS_REPORT_AE_SB contents

Field Name	Number of bytes	Description
SBLKID	2	Value = 0x102C
SBLKLEN	2	Value = 20
STATUS_FLAGS	2	Status flags indicating pass fail results corresponding to various threshold checks under this monitor. Bit STATUS_FLAG for monitor b0 STATUS_GPADC_REF1 b1 STATUS_GPADC_REF2 b15:2 RESERVED 0 – FAIL or check wasn't done 1 – PASS
ERROR_CODE	2	Indicates any error reported during monitoring Value of 0 indicates no error
GPADC_REF1_VALUE	2	The measured GPADC outputs corresponding to internal DC signal (GPADC_REF1, expected level 0.45V) is reported here. 1 LSB = 1.8V/1024
GPADC_REF2_VALUE	2	The measured GPADC outputs corresponding to internal DC signal (GPADC_REF2, expected level 1.2V) is reported here. 1 LSB = 1.8V/1024
RESERVED	4	0x00000000
TIME_STAMP	4	This field indicates when the last monitoring in the enabled set was performed. 1 LSB = 1 millisecond (time stamp rolls over upon exceeding allotted bit width)

5.14.14 Sub block 0x102D – AWR_MONITOR_PLL_CONTROL_VOLTAGE_REPORT_AE_SB

This API is a Monitoring Report API which the AWR device sends to the host, containing the measured PLL control voltage values during explicit monitoring chirps. The AWR device sends this to host at the programmed periodicity or when failure occurs, as programmed by the configuration API SB.

Table 5.109: AWR_MONITOR_PLL_CONTROL_VOLTAGE_REPORT_AE_SB contents

Field Name	Number of bytes	Description
SBLKID	2	Value = 0x102D
SBLKLEN	2	Value = 32
STATUS_FLAGS	2	Status flags indicating pass fail results corresponding to various threshold checks under this monitor. Bit STATUS_FLAG for monitor b0 STATUS_APLL_VCTRL b1 STATUS_SYNTH_VCO1_VCTRL_MAX_FREQ b2 STATUS_SYNTH_VCO1_VCTRL_MIN_FREQ b3 RESERVED b4 STATUS_SYNTH_VCO2_VCTRL_MAX_FREQ b5 STATUS_SYNTH_VCO2_VCTRL_MIN_FREQ b6 RESERVED b15:7 RESERVED 0 – FAIL or check wasn't done 1 – PASS
ERROR_CODE	2	Indicates any error reported during monitoring Value of 0 indicates no error

Continued on next page

Table 5.109 – continued from previous page

PLL_CONTROL_VOLTAGE_VALUES	16	<p>The measured values of PLL control voltage levels and Synthesizer VCO slopes are reported here.</p> <p>Byte numbers corresponding to different control voltage values reported in this field are here:</p> <table border="1"> <thead> <tr> <th>Bytes</th> <th>SIGNAL</th> <th>1 LSB</th> </tr> </thead> <tbody> <tr> <td>1:0</td> <td>APLL_VCTRL</td> <td>1 mV</td> </tr> <tr> <td>3:2</td> <td>SYNTH_VCO1_VCTRL_MAX_FREQ</td> <td>1 mV</td> </tr> <tr> <td>5:4</td> <td>SYNTH_VCO1_VCTRL_MIN_FREQ</td> <td>1 mV</td> </tr> <tr> <td>7:6</td> <td>SYNTH_VCO1_SLOPE</td> <td>1 MHz/V</td> </tr> <tr> <td>9:8</td> <td>SYNTH_VCO2_VCTRL_MAX_FREQ</td> <td>1 mV</td> </tr> <tr> <td>11:10</td> <td>SYNTH_VCO2_VCTRL_MIN_FREQ</td> <td>1 mV</td> </tr> <tr> <td>13:12</td> <td>SYNTH_VCO2_SLOPE</td> <td>1 MHz/V</td> </tr> <tr> <td>15:14</td> <td>RESERVED</td> <td>RESERVED</td> </tr> </tbody> </table> <p>Only the fields corresponding to the enabled monitors are valid. The failure thresholds are based on the following: Valid VCTRL values are [140 to 1400] mV. Valid VCO1_SLOPE values are [1760 to 2640] MHz/V. Valid VCO2_SLOPE values are [3520 to 5280] MHz/V.</p> <p>NOTE: The VCO_x_SLOPE should be ignored when synth fault is injected.</p>	Bytes	SIGNAL	1 LSB	1:0	APLL_VCTRL	1 mV	3:2	SYNTH_VCO1_VCTRL_MAX_FREQ	1 mV	5:4	SYNTH_VCO1_VCTRL_MIN_FREQ	1 mV	7:6	SYNTH_VCO1_SLOPE	1 MHz/V	9:8	SYNTH_VCO2_VCTRL_MAX_FREQ	1 mV	11:10	SYNTH_VCO2_VCTRL_MIN_FREQ	1 mV	13:12	SYNTH_VCO2_SLOPE	1 MHz/V	15:14	RESERVED	RESERVED
Bytes	SIGNAL	1 LSB																											
1:0	APLL_VCTRL	1 mV																											
3:2	SYNTH_VCO1_VCTRL_MAX_FREQ	1 mV																											
5:4	SYNTH_VCO1_VCTRL_MIN_FREQ	1 mV																											
7:6	SYNTH_VCO1_SLOPE	1 MHz/V																											
9:8	SYNTH_VCO2_VCTRL_MAX_FREQ	1 mV																											
11:10	SYNTH_VCO2_VCTRL_MIN_FREQ	1 mV																											
13:12	SYNTH_VCO2_SLOPE	1 MHz/V																											
15:14	RESERVED	RESERVED																											
RESERVED	4	0x00000000																											
TIME_STAMP	4	<p>This field indicates when the last monitoring in the enabled set was performed.</p> <p>1 LSB = 1 millisecond (time stamp rolls over upon exceeding allotted bit width)</p>																											

5.14.15 Sub block 0x102E – AWR_MONITOR_DUAL_CLOCK_COMP_REPORT_AE_SB

This API is a monitoring report API which the AWR device sends to the host, containing information about the relative frequency measurements. The AWR device sends this to host at the programmed periodicity or when failure occurs, as programmed by the configuration API SB.

Table 5.110: AWR_MONITOR_DUAL_CLOCK_COMP_REPORT_AE_SB contents

Field Name	Number of bytes	Description																					
SBLKID	2	Value = 0x102E																					
SBLKLEN	2	Value = 32																					
STATUS_FLAGS	2	<p>Status flags indicating pass fail results corresponding to various threshold checks under this monitor.</p> <p>Bit STATUS_FLAG for monitor</p> <p>b0 STATUS_CLK_PAIR0</p> <p>b1 STATUS_CLK_PAIR1</p> <p>b2 STATUS_CLK_PAIR2</p> <p>b3 STATUS_CLK_PAIR3</p> <p>b4 STATUS_CLK_PAIR4</p> <p>b15:5 RESERVED</p> <p>0 – FAIL or check wasn't done</p> <p>1 – PASS</p>																					
ERROR_CODE	2	<p>Indicates any error reported during monitoring</p> <p>Value of 0 indicates no error</p>																					
FREQ_MEAS_VALUES	16	<p>The measured clock frequencies from the enabled clock pair measurements are reported here.</p> <p>Byte numbers corresponding to different frequency measurement values reported in this field are here:</p> <table border="1"> <thead> <tr> <th>Bytes</th> <th>CLOCK PAIR</th> <th>MEASURED CLOCK FREQUENCY</th> </tr> </thead> <tbody> <tr> <td>1:0</td> <td>0</td> <td>BSS_600M</td> </tr> <tr> <td>3:2</td> <td>1</td> <td>BSS_200M</td> </tr> <tr> <td>5:4</td> <td>2</td> <td>BSS_100M</td> </tr> <tr> <td>7:6</td> <td>3</td> <td>GPADC_10M</td> </tr> <tr> <td>9:8</td> <td>4</td> <td>RCOSC_10M</td> </tr> <tr> <td>15:10</td> <td>RESERVED</td> <td>RESERVED</td> </tr> </tbody> </table> <p>1 LSB = 0.1 MHz, unsigned number</p>	Bytes	CLOCK PAIR	MEASURED CLOCK FREQUENCY	1:0	0	BSS_600M	3:2	1	BSS_200M	5:4	2	BSS_100M	7:6	3	GPADC_10M	9:8	4	RCOSC_10M	15:10	RESERVED	RESERVED
Bytes	CLOCK PAIR	MEASURED CLOCK FREQUENCY																					
1:0	0	BSS_600M																					
3:2	1	BSS_200M																					
5:4	2	BSS_100M																					
7:6	3	GPADC_10M																					
9:8	4	RCOSC_10M																					
15:10	RESERVED	RESERVED																					
RESERVED	4	0x00000000																					
TIME_STAMP	4	<p>This field indicates when the last monitoring in the enabled set was performed.</p> <p>1 LSB = 1 millisecond (time stamp rolls over upon exceeding allotted bit width)</p>																					

5.14.16 Sub block 0x1031 – AWR_MONITOR_RX_MIXER_IN_POWER_REPORT_AE_SB

This API is a Monitoring Report API which the AWR device sends to the host, containing the measured RX mixer input voltage swing values. The AWR device sends this to host at the programmed periodicity or when failure occurs, as programmed by the configuration API SB.

Table 5.111: AWR_MONITOR_RX_MIXER_IN_POWER_REPORT_AE_SB contents

Field Name	Number of bytes	Description										
SBLKID	2	Value = 0x1031										
SBLKLEN	2	Value = 24										
STATUS_FLAGS	2	Bit STATUS_FLAG for monitor b0 STATUS_MIXER_IN_POWER_RX0 b1 STATUS_MIXER_IN_POWER_RX1 b2 STATUS_MIXER_IN_POWER_RX2 b3 STATUS_MIXER_IN_POWER_RX3 b15:4 RESERVED 0 – FAIL or check wasn't done 1 – PASS										
ERROR_CODE	2	Internal sanity check violations are reported here. Value = 0: No error Other values: Error (see error code definition matrix)										
PROFILE_INDX	1	Profile Index for which this monitoring report applies										
RESERVED	3	0x000000										
RX_MIXER_IN_VOLTAGE_VALUE	4	The measured RX mixer input voltage swing values are reported here. The byte location of the value for each receivers is tabulated here: <table border="1"> <thead> <tr> <th>Receiver</th> <th>Byte Location</th> </tr> </thead> <tbody> <tr> <td>RX0</td> <td>0</td> </tr> <tr> <td>RX1</td> <td>1</td> </tr> <tr> <td>RX2</td> <td>2</td> </tr> <tr> <td>RX3</td> <td>3</td> </tr> </tbody> </table> 1 LSB = 1800 mV/256, unsigned number Only the entries of enabled RX channels are valid.	Receiver	Byte Location	RX0	0	RX1	1	RX2	2	RX3	3
Receiver	Byte Location											
RX0	0											
RX1	1											
RX2	2											
RX3	3											
RESERVED	4	0x00000000										
TIME_STAMP	4	When this monitoring began is indicated here. 1 LSB = 1 millisecond (time stamp rolls over upon exceeding allotted bit width)										

5.14.17 Sub block 0x1033 – AWR_MONITOR_SYNTHESIZER_FREQUENCY_NONLIVE_REPORT_AE_SB

This is a new feature addition in **xWR6843** device only. This API is a Non live Monitoring Report SB, which device sends to the host, containing information related to measured frequency error during the monitoring chirp for two profiles configurations. The device sends this to host at the programmed periodicity or when failure occurs, as programmed by the configuration API SB.

Table 5.112: AWR_MONITOR_SYNTHESIZER_FREQUENCY_NONLIVE_REPORT_AE_SB contents

Field Name	Number of bytes	Description
SBLKID	2	Value = 0x1033
SBLKLEN	2	Value = 52
STATUS_FLAGS	2	Status flag indicating pass fail results corresponding to various threshold checks under this monitor. Bit STATUS_FLAG for monitor b0 VCO1_SYNTH_FREQ_ERR_STATUS b1 VCO2_SYNTH_FREQ_ERR_STATUS b15:2 RESERVED 0 – FAIL or check wasn't done 1 – PASS
ERROR_CODE	2	Indicates any error reported during monitoring Value of 0 indicates no error
PROFILE_INDX_0	1	VCO1 Profile index for which this monitoring report applies
RESERVED	3	0x000000
MAX_FREQUENCY_ERROR_VALUE_0	4	This field indicates the maximum instantaneous frequency error measured during the monitoring chirp for which frequency monitoring has been enabled in the previous monitoring period for VCO1 profile. Bits Parameter b31:0 Maximum frequency error value, signed number. 1 LSB = 1 kHz.

Continued on next page

Table 5.112 – continued from previous page

FREQUENCY_FAILURE_COUNT_0	4	This field indicates the number of times during chirping in the previous monitoring period in which the measured frequency error violated the allowed threshold for VCO1 profile. Frequency error threshold violation is counted every 10 ns. Bits Parameter b31:19 RESERVED b18:0 Failure count, unsigned number
MAX_FREQ_FAILURE_TIME_0	4	This field indicates the time at which error occurred for VCO1 profile w.r.t. knee of the ramp. 1LSB = 10ns
RESERVED	4	0x00000000
PROFILE_INDX_1	1	VCO2 Profile index for which this monitoring report applies
RESERVED	3	0x000000
MAX_FREQUENCY_ERROR_VALUE_1	4	This field indicates the maximum instantaneous frequency error measured during the monitoring chirp for which frequency monitoring has been enabled in the previous monitoring period for VCO2 profile. Bits Parameter b31:0 Maximum frequency error value, signed number. 1 LSB = 1 kHz.
FREQUENCY_FAILURE_COUNT_1	4	This field indicates the number of times during chirping in the previous monitoring period in which the measured frequency error violated the allowed threshold for VCO2 profile. Frequency error threshold violation is counted every 10 ns. Bits Parameter b31:19 RESERVED b18:0 Failure count, unsigned number
MAX_FREQ_FAILURE_TIME_1	4	This field indicates the time at which error occurred for VCO2 profile w.r.t. knee of the ramp. 1LSB = 10ns
RESERVED	4	0x00000000
TIME_STAMP	4	This field indicates when the last monitoring in the enabled set was performed. 1 LSB = 1 millisecond (time stamp rolls over upon exceeding allotted bit width)

5.15 Sub blocks related to AWR_DEV_RFPOWERUP_MSG

NOTE: All device config APIs having sub block ID \geq 0x4000 are applicable only for MSS in AWR1243 RF front end devices, for other xWR1443, xWR1642 and xWR1843 devices, these APIs are for reference only.

5.15.1 Sub block 0x4000 – AWR_DEV_RFPOWERUP_SB

This sub block is a command to power up the BSS

5.113 describes the content of this sub block.

Table 5.113: AWR_DEV_POWERUP_SB contents

Field Name	Number of bytes	Description
SBLKID	2	Value = 0x4000
SBLKLEN	2	Value = 4

5.16 Sub blocks related to AWR_DEV_CONF_SET_MSG

5.16.1 Sub block 0x4040 – AWR_DEV_MCUCLOCK_CONF_SET_SB

This sub block contains the configurations to setup the desired frequency of the MCU Clock that is output from the device.

Table 5.114 describes the contents of this sub block.

Table 5.114: AWR_DEV_MCUCLOCK_CONF_SET_SB contents

Field Name	Number of bytes	Description
SBLKID	2	Value = 0x4040
SBLKLEN	2	Value = 8
MCUCLOCK_CTRL	1	This field controls the enable-disable of the MCU clock. Value Description 0x0 Disable MCU clock 0x1 Enable MCU clock

Continued on next page

Table 5.114 – continued from previous page

MCUCLOCK_SRC	1	This field specifies the source of the MCU clock. Applicable only in case of MCU clock enable. Else ignored. Value Description 0x0 XTAL (as connected to the device) 0x2 600MHz PLL divided clock
SRCLOCK_DIV	1	This field specifies the division factor to be applied to source clock. Applicable only in case of MCU clock enable. Else ignored. Value Description 0x0 Divide by 1 0x1 Divide by 2 0xFF Divide by 256
RESERVED	1	0x00

5.16.2 Sub block 0x4041 – AWR_DEV_RX_DATA_FORMAT_CONF_SET_SB

This sub block contains the configuration of the data format of the samples received over the receive chain to be transferred out to an external host over the configured data path (LVDS or CSI2).

Table 5.115 describes the content of this sub block.

Table 5.115: AWR_DEV_RX_DATA_FORMAT_CONF_SB contents

Field Name	Number of bytes	Description
SBLKID	2	Value = 0x4041
SBLKLEN	2	Value = 16

Continued on next page

Table 5.115 – continued from previous page

RX_CHAN_EN	2	Bits Definition b0 RX_CHAN0_EN 0 Disable RX Channel 0 1 Enable RX Channel 0 b1 RX_CHAN0_EN 0 Disable RX Channel 1 1 Enable RX Channel 1 b2 RX_CHAN0_EN 0 Disable RX Channel 2 1 Enable RX Channel 2 b3 RX_CHAN0_EN 0 Disable RX Channel 3 1 Enable RX Channel 3 b15:4 RESERVED
NUM_ADC_BITS	2	Bits Definition b1:0 00 12 bits 01 14 bits 10 16 bits Other Reserved b15:2 RESERVED
ADC_OUT_FMT	2	Bits Definition b1:0 00 Real 01 Complex Other Reserved b15:2 RESERVED
IQ_SWAP_SEL	1	Bits Definition b1:0 To swap the IQ samples (if complex format) 00 Sample interleave mode – I first 01 Sample interleave mode – Q first Other Reserved b7:2 RESERVED

Continued on next page

Table 5.115 – continued from previous page

CHAN_INTER-LEAVE	1	Bits	Definition
		b1:0	Channel interleaving of the samples stored in the ADC buffer to be transferred out on the data path. 00 Interleaved mode of storage 01 Non-interleaved mode of storage Other Reserved
RESERVED	4	b7:2	RESERVED
		0x00000000	

5.16.3 Sub block 0x4042 – AWR_DEV_RX_DATA_PATH_CONF_SET_SB

This sub block contains the configurations of the data path to transfer the captured ADC samples received over the receive chain to be transferred out to an external host.

Table 5.116 describes the content of this sub block.

Table 5.116: AWR_DEV_RX_DATA_PATH_CONF_SB contents

Field Name	Number of bytes	Description
SBLKID	2	Value = 0x4042
SBLKLEN	2	Value = 12
DATA_INTF_SEL	1	This field specifies the data path selected to transfer the Radar info. Value Description 0x0 CSI2 interface select 0x1 LVDS interface select

Continued on next page

Table 5.116 – continued from previous page

DATA_TRANS_ FMT_PKT0	1	Bits	Description
		b5:0	Packet 0 content selection Value Definition 000001 ADC 000110 CP_ADC (See note at the bottom of this table) 001001 ADC_CP 110110 CP_ADC_CQ (See note at the bottom of this table)
		b7:6	Packet 0 virtual channel number (valid only for CSI2) Value Definition 00 Virtual channel number 0 (Default) 01 Virtual channel number 1 10 Virtual channel number 2 11 Virtual channel number 3
DATA_TRANS_ FMT_PKT1	1	Bits	Description
		b5:0	Packet 1 content selection Value Definition 000000 Suppress packet 1 transmission 001110 CP_CQ (See note at the bottom of this table) 001011 CQ_CP (See note at the bottom of this table)
		b7:6	Packet 1 virtual channel number (valid only for CSI2) Value Definition 00 Virtual channel number 0 (Default) 01 Virtual channel number 1 10 Virtual channel number 2 11 Virtual channel number 3

Continued on next page

Table 5.116 – continued from previous page

CQ_CONFIG	1	<p>This specifies the data size of CQ samples on the lanes</p> <table border="1"> <thead> <tr> <th>Bits</th> <th>Description</th> <th>b1:0 Value</th> <th>Definition</th> </tr> </thead> <tbody> <tr> <td></td> <td></td> <td>00</td> <td>12 bit</td> </tr> <tr> <td></td> <td></td> <td>01</td> <td>14 bit</td> </tr> <tr> <td></td> <td></td> <td>10</td> <td>16 bit</td> </tr> <tr> <td></td> <td></td> <td>11</td> <td>RESERVED</td> </tr> </tbody> </table> <p>b7:2 RESERVED</p> <p>NOTE: The CQ size can be configured only if CQ and ADC data is sent in separate packets. When ADC and CQ is sent in the same packet, then CQ size will be same as ADC data size.</p>	Bits	Description	b1:0 Value	Definition			00	12 bit			01	14 bit			10	16 bit			11	RESERVED
Bits	Description	b1:0 Value	Definition																			
		00	12 bit																			
		01	14 bit																			
		10	16 bit																			
		11	RESERVED																			
CQ0_TRANS_SIZE	1	<p>Number of samples (in 16 bit halfwords) of CQ0 data to be transferred. Valid range [32 halfwords to 128 halfwords] Value 0 = Disabled.</p> <p>NOTE: Ensure that the number of halfwords specified are a multiple of the number of lanes selected.</p>																				
CQ1_TRANS_SIZE	1	<p>Number of samples (in 16 bit halfwords) of CQ1 data to be transferred. Valid range [32 halfwords to 128 halfwords] Value 0 = Disabled.</p> <p>NOTE: Ensure that the number of halfwords specified are a multiple of the number of lanes selected.</p>																				
CQ2_TRANS_SIZE	1	<p>Number of samples (in 16 bit halfwords) of CQ2 data to be transferred. Valid range [32 halfwords to 128 halfwords] Value 0 = Disabled.</p> <p>NOTE: Ensure that the number of halfwords specified are a multiple of the number of lanes selected.</p>																				
RESERVED	1	0x00																				

NOTE1:	<p>CP is Chirp Parameter information which is defined for each RX as follows</p> <table border="1"> <thead> <tr> <th>Bit</th> <th>Description</th> </tr> </thead> <tbody> <tr> <td>b11:0</td> <td> Chirp number In legacy frame configuration, chirp number for starts from 1 and increments for each chirp within the frame and resets to 0 for the next frame. In advanced frame configuration chirp number starts from 1 and increments for each chirp within the burst and resets to 0 for the next burst. </td> </tr> <tr> <td>b15:12</td> <td>RESERVED</td> </tr> <tr> <td>b17:16</td> <td> Channel number The receive channel number which is encoded as <table border="1"> <thead> <tr> <th>Bit</th> <th>RX</th> </tr> </thead> <tbody> <tr> <td>00</td> <td>RX0</td> </tr> <tr> <td>01</td> <td>RX1</td> </tr> <tr> <td>10</td> <td>RX2</td> </tr> <tr> <td>11</td> <td>RX3</td> </tr> </tbody> </table> </td> </tr> <tr> <td>b21:18</td> <td> Profile number The profile number to which the chirp belongs </td> </tr> <tr> <td>b31:22</td> <td>RESERVED</td> </tr> </tbody> </table>	Bit	Description	b11:0	Chirp number In legacy frame configuration, chirp number for starts from 1 and increments for each chirp within the frame and resets to 0 for the next frame. In advanced frame configuration chirp number starts from 1 and increments for each chirp within the burst and resets to 0 for the next burst.	b15:12	RESERVED	b17:16	Channel number The receive channel number which is encoded as <table border="1"> <thead> <tr> <th>Bit</th> <th>RX</th> </tr> </thead> <tbody> <tr> <td>00</td> <td>RX0</td> </tr> <tr> <td>01</td> <td>RX1</td> </tr> <tr> <td>10</td> <td>RX2</td> </tr> <tr> <td>11</td> <td>RX3</td> </tr> </tbody> </table>	Bit	RX	00	RX0	01	RX1	10	RX2	11	RX3	b21:18	Profile number The profile number to which the chirp belongs	b31:22	RESERVED
Bit	Description																						
b11:0	Chirp number In legacy frame configuration, chirp number for starts from 1 and increments for each chirp within the frame and resets to 0 for the next frame. In advanced frame configuration chirp number starts from 1 and increments for each chirp within the burst and resets to 0 for the next burst.																						
b15:12	RESERVED																						
b17:16	Channel number The receive channel number which is encoded as <table border="1"> <thead> <tr> <th>Bit</th> <th>RX</th> </tr> </thead> <tbody> <tr> <td>00</td> <td>RX0</td> </tr> <tr> <td>01</td> <td>RX1</td> </tr> <tr> <td>10</td> <td>RX2</td> </tr> <tr> <td>11</td> <td>RX3</td> </tr> </tbody> </table>	Bit	RX	00	RX0	01	RX1	10	RX2	11	RX3												
Bit	RX																						
00	RX0																						
01	RX1																						
10	RX2																						
11	RX3																						
b21:18	Profile number The profile number to which the chirp belongs																						
b31:22	RESERVED																						
NOTE2:	CQ is Chirp Quality information which is defined in Section 10																						

5.16.4 Sub block 0x4043 – AWR_DEV_RX_DATA_PATH_LANEEN_SET_SB

This sub block contains the configurations to enables the lanes of the LVDS/CSI2 path to transfer Radar information to an external host.

Table 5.117 describes the content of this sub block.

Table 5.117: AWR_DEV_RX_DATA_PATH_LANEEN_SET_SB contents

Field Name	Number of bytes	Description
SBLKID	2	Value = 0x4043
SBLKLEN	2	Value = 8

Continued on next page

Table 5.117 – continued from previous page

LANE_EN	2	Bits	Description
		b0	LANE0_EN 0 Disable lane 0 1 Enable lane 0
		b1	LANE1_EN 0 Disable lane 1 1 Enable lane 1
		b2	LANE2_EN 0 Disable lane 2 1 Enable lane 2
		b3	LANE3_EN 0 Disable lane 3 1 Enable lane 3
		b15:4	RESERVED
RESERVED	2	0x0000	

5.16.5 Sub block 0x4044 – AWR_DEV_RX_DATA_PATH_CLK_SET_SB

This sub block contains the clock configurations for data transfer on the LVDS/CSI2 lanes. Table 5.118 describes the content of this sub block.

Table 5.118: AWR_DEV_RX_DATA_PATH_CLK_SET_SB contents

Field Name	Number of bytes	Description	
SBLKID	2	Value = 0x4044	
SBLKLEN	2	Value = 8	
LANE_CLK_CFG (Selection valid only for LVDS. For CSI2, DDR is used always)	1	Bits	Description
		b0	BIT_CLK_SEL 0 SDR clock 1 DDR clock (Only valid value for CSI2)
		b7:1	RESERVED

Continued on next page

Table 5.118 – continued from previous page

DATA_RATE	1	Data rate selection
		Value Description
		0001b 600 Mbps (DDR only)
		0010b 450 Mbps (SDR, DDR)
		0011b 400 Mbps (DDR only)
		0100b 300 Mbps (SDR, DDR)
		0101b 225 Mbps (DDR only)
		0110b 150 Mbps (DDR only)
Others RESERVED		
RESERVED	2	0x0000

5.16.6 Sub block 0x4045 – AWR_DEV_LVDS_CFG_SET_SB

This sub block contains the configurations of the LVDS lanes.

Table 5.119 describes the content of this sub block.

Table 5.119: AWR_DEV_LVDS_CFG_SET_SB contents

Field Name	Number of bytes	Description
SBLKID	2	Value = 0x4045
SBLKLEN	2	Value = 8
LANE_FMT_MAP	2	LANE0 Format Map. The mapping of the data on the lanes is depicted in the figure below 0x0000 Format map 0 0x0001 Format map 1

Continued on next page

Table 5.119 – continued from previous page

LANE_PARAM_CFG	2	Bit	Description
		b0	MSB_FIRST 0 Disable (LSB First) 1 Enable (MSB First)
		b1	Packet End Pulse Enable 0 Disable 1 Enable
		b2	CRC Enable 0 Disable 1 Enable
		b7:3	RESERVED
		b8	Configures LSB/MSB first for CRC 0 CRC value swapped wrt to MSB_FIRST setting 1 CRC value follows MSB_FIRST setting
		b9	Frame clock state during idle 0 Frame clock is held low 1 Frame clock is held high
		b10	Frame clock period for CRC(when CRC enabled - b2) 0 32-bit CRC is trasmitted as single sample with frame clock set to 16high, 16low configuration 1 32-bit CRC is trasmitted as single sample with frame clock set to 8high, 8low configuration
		b11	Bit clock state during idle 0 Bit clock toggles during idle when there are no transmission 1 Bit clock doesn't toggle during idle when there are no transmission, the value of bit clock is held low
		b12	CRC inversion control(when CRC enabled - b2) 0 The calculated value of 32-bit ethernet polynomial CRC is inverted and sent out 1 The calculated value of 32-bit ethernet polynomial CRC is sent without inversion
		b15:13	RESERVED

Continued on next page

Table 5.119 – continued from previous page

The mapping of the 8 sample ($8 \times 16 = 128$ bit) information onto the serial interface lanes is determined by the LANE_FMT_MAP parameter. The choice of format map translating to the transfer of data on the lanes is depicted in the image below (the x axis represents time – hence the samples are as available on the lanes in time and the receiver will receive the samples in the reverse order as depicted below).

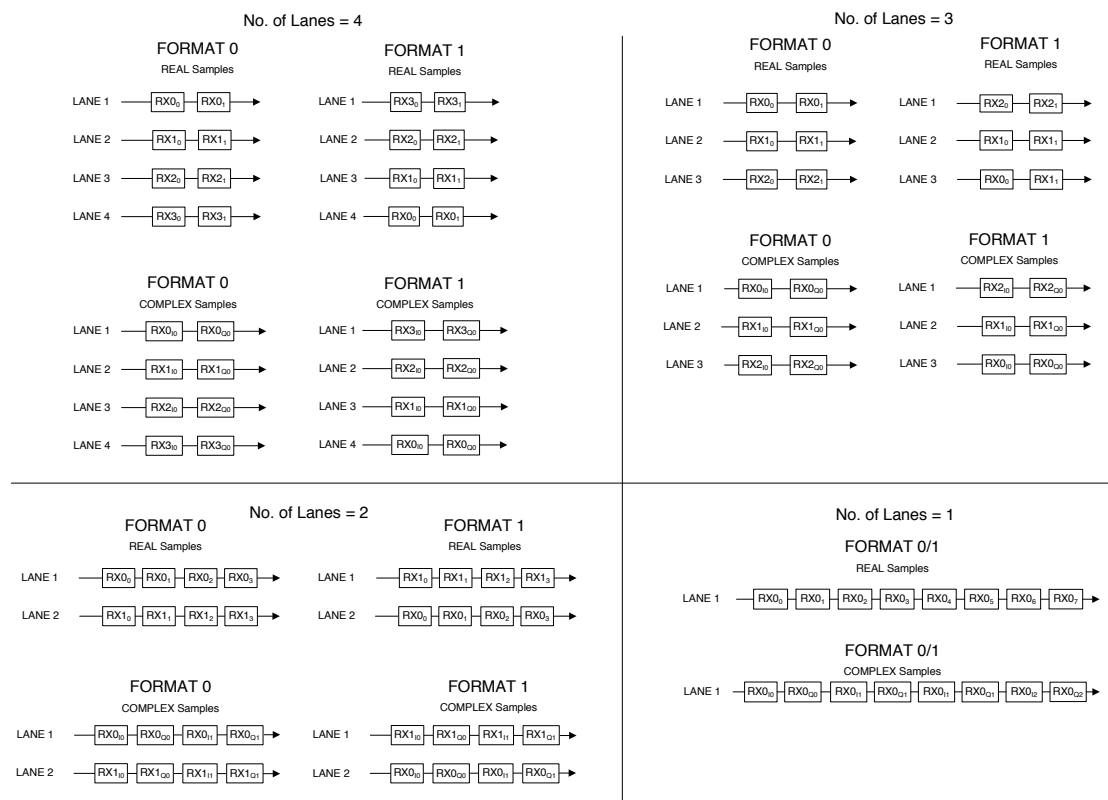
Figure 5.4: Lane formats and the order of receiving the data from the lanes

5.16.7 Sub block 0x4046 – AWR_DEV_RX_CONTSTREAMING_MODE_CONF_SET_SB

This sub block contains the configurations of the data path to transfer the captured ADC samples continuously without any break to an external host.

Table 5.120 describes the content of this sub block.

Table 5.120: AWR_DEV_RX_CONTSTREAMING_MODE_CFG_SET_SB contents

Field Name	Number of bytes	Description
SBLKID	2	Value = 0x4046
SBLKLEN	2	Value = 8
CONT_STREAMING_MODE	2	Continuous streaming mode enable Value Description 0x0 Continuous streaming mode data transfer disable 0x1 Continuous streaming mode data transfer enable
RESERVED	2	0x0000

5.16.8 Sub block 0x4047 – AWR_DEV_CSI2_CFG_SET_SB

This sub block contains the various configurations of the parameters of the CSI2 module. Table 5.121 describes the content of this sub block.

Table 5.121: AWR_DEV_CSI2_CFG_SET_SB contents

Field Name	Number of bytes	Description
SBLKID	2	Value = 0x4047
SBLKLEN	2	Value = 12

Continued on next page

Table 5.121 – continued from previous page

LANE_POS_ POL_SEL	4	Bits	Definition
		b2:0	DATA_LANE0_POS Valid values (Should be a unique position if lane 0 is enabled, ignored if lane 0 is not enabled): 000b – Unused, 001b – Position 1 (default), 010b – Position 2, 011b – Position 3, 100b – Position 4, 101b – Position 5
		b3	DATA_LANE0_POL 0b – PLUSMINUS pin order, 1b – MINUSPLUS pin order
		b6:4	DATA_LANE1_POS Valid values (Should be a unique position if lane 1 is enabled, ignored if lane 1 is not enabled): 000b – Unused, 001b – Position 1, 010b – Position 2 (default), 011b – Position 3, 100b – Position 4, 101b – Position 5
		b7	DATA_LANE1_POL 0b – PLUSMINUS pin order, 1b – MINUSPLUS pin order
		b10:8	DATA_LANE2_POS Valid values (Should be a unique position if lane 2 is enabled, ignored if lane 2 is not enabled): 000b – Unused, 001b – Position 1, 010b – Position 2, 011b – Position 3, 100b – Position 4 (default), 101b – Position 5
		b11	DATA_LANE2_POL 0b – PLUSMINUS pin order, 1b – MINUSPLUS pin order
		b14:12	DATA_LANE3_POS Valid values (Should be a unique position if lane 3 is enabled, ignored if lane 3 is not enabled): 000b – Unused, 001b – Position 1, 010b – Position 2, 011b – Position 3, 100b – Position 4, 101b – Position 5 (default)
		b15	DATA_LANE3_POL 0b – PLUSMINUS pin order, 1b – MINUSPLUS pin order
		b18:16	CLOCK_POS Valid values (Should be a unique position): 0000b – Unused, 001b – Unused, 010b – Position 2, 011b – Position 3 (default), 100b – Position 4
		b19	CLOCK_POL 0b – PLUSMINUS pin order, 1b – MINUSPLUS pin order
		b31:20	RESERVED

Continued on next page

Table 5.121 – continued from previous page

RESERVED	4	0x00000000
----------	---	------------

5.16.9 Sub block 0x4048 – AWR_DEV_PMICCLOCK_CONF_SET_SB

This sub block contains the configurations to setup the desired frequency of the PMIC Clock that is output from the device. The configurations also allow setting up the dither values for the clock. Table 5.122 describes the contents of this sub block.

Table 5.122: AWR_DEV_PMICCLOCK_CONF_SET_SB contents

Field Name	Number of bytes	Description
SBLKID	2	Value = 0x4048
SBLKLEN	2	Value = 16
PMICCLOCK_CTRL	1	This field controls the enable-disable of the PMIC clock. Value Description 0x0 Disable PMIC clock 0x1 Enable PMIC clock
PMICCLOCK_SRC	1	This field specifies the source of the PMIC clock. Applicable only in case of PMIC clock enable. Else ignored. Value Description 0x0 XTAL (as connected to the device) 0x2 600 MHz PLL divided clock
SRCLOCK_DIV	1	This field specifies the division factor to be applied to source clock. Applicable only in case of PMIC clock enable. Else ignored. Value Description 0x0 Divide by 1 (Not supported) 0x1 Divide by 2 0xFF Divide by 256

Continued on next page

Table 5.122 – continued from previous page

MODE_SELECT	1	<p>This field specifies the mode of operation for the PMIC clock generation. Applicable only in case of PMIC clock enable. Else ignored.</p> <p>Value Description</p> <p>0x0 Continuous mode (free running mode where the frequency change/jump is triggered based on configured number of PMIC clock ticks)</p> <p>0x1 Chirp-to-Chirp staircase mode (frequency change/jump is triggered at every chirp boundary)</p>
FREQ_SLOPE	4	<p>Applicable only in case of PMIC clock enable. Else ignored.</p> <p>Bit Description</p> <p>b25:0 Frequency slope value to be applied in [7.18] unsigned format 1 LSB = $1/2^{18}$</p> <p>b31:26 RESERVED</p> <p>In continuous mode this value is accumulated every PMIC clock tick with the seed as MIN_NDIV_VAL till MAX_NDIV_VAL is reached</p> <p>In the stair case mode this value is accumulated every chirp with the seed as MIN_NDIV_VAL till MAX_NDIV_VAL is reached</p>
MIN_NDIV_VAL	1	<p>Applicable only in case of PMIC clock enable. Else ignored.</p> <p>Minimum allowed divider value (depends upon the highest desired clock frequency)</p>
MAX_NDIV_VAL	1	<p>Applicable only in case of PMIC clock enable. Else ignored.</p> <p>Maximum allowed divider value (depends upon the lowest desired clock frequency)</p>
CLK_DITHER_EN	1	<p>Applicable only in case of PMIC clock enable and frequency slope is non-zero. Else ignored.</p> <p>This field controls the enable-disable of the clock dithering. Adds a pseudo random real number (0 or 1) to the accumulated divide value. Hence it brings a random dithering of 1 LSB.</p> <p>Value Description</p> <p>0x0 Clock dithering disabled</p> <p>0x1 Clock dithering enabled</p>
RESERVED	1	0x00

Example 1. PMIC clock with no slope in continuous mode

Objective: To configure the PMIC clock at frequency of 2 MHz with no slope.

Configurations:

1. PMICCLK_SRC = 0x2 (600 MHz PLL divided clock)
2. SRCLOCK_DIV = 29, Reference clock = $600 \text{ MHz} / (29 + 1) = 20 \text{ MHz}$
3. MIN_NDIV_VAL = MAX_NDIV_VAL = 10 (Computed as $20 \text{ MHz} / 2.0 \text{ MHz}$)
4. FREQ_SLOPE = 0

With the above configuration, the PMIC clock frequency would be $\text{PMIC clock} = (20 \text{ MHz} / 10) = 2 \text{ MHz}$

Example 2. Dithered PMIC clock with slope in chirp-to-chirp staircase mode

Objective: To configure a dithered PMIC clock at frequencies ranging from 2 MHz to 2.5 MHz over 32 chirps.

Configurations:

1. PMICCLK_SRC = 0x2 (600 MHz PLL divided clock)
2. SRCLOCK_DIV = 2, Reference clock = $600 \text{ MHz} / (2 + 1) = 200 \text{ MHz}$
3. MODE_SELECT = 1
4. FREQ_SLOPE = 169125 (Computed as $(\text{MAX_NDIV_VAL} - \text{MIN_NDIV_VAL}) \times 2^{18} / 31$)
5. MIN_NDIV_VAL = 80 (Computed as $200 \text{ MHz} / 2.5 \text{ MHz}$)
6. MAX_NDIV_VAL = 100 (Computed as $200 \text{ MHz} / 2.0 \text{ MHz}$)
7. CLK_DITHER_EN = 1

With the above configuration, the PMIC clock frequency would be vary between $(200 \text{ MHz} / 80)$ and $(200 \text{ MHz} / 100)$ in steps of $(200 \text{ MHz} / [(80 + (N \times \text{FREQ_SLOPE} / 2^{18} + X))])$ where

- N = Chirp number
- X = random fractional value in the range (0, 1) that adds the dither

The PMIC clock frequency is determined by the clock divider value which starts with a value of 100, providing a PMIC clock of 2 MHz for the 1st chirp, decrementing the divider by $\text{FREQ_SLOPE} / 2^{18} = 0.64516$ every chirp and finally reaching a value of 20 for the 32nd chirp providing a PMIC clock of 2.5 MHz.

Table 5.123: PMIC clock frequency across chirps in chirp-to-chirp staircase mode in an example when PMIC clock varies from 2 MHz to 2.5 MHz in 32 chirps

Chirp Number	PMIC Clock Frequency (MHz)	Calculation
1	2.50000	$200/(80 + 0 \times 169125/2^{18})$
2	2.48000	$200/(80 + 1 \times 169125/2^{18})$
3	2.46032	$200/(80 + 2 \times 169125/2^{18})$
4	2.44094	$200/(80 + 3 \times 169125/2^{18})$
5	2.42188	$200/(80 + 4 \times 169125/2^{18})$
6	2.40310	$200/(80 + 5 \times 169125/2^{18})$
7	2.38462	$200/(80 + 6 \times 169125/2^{18})$
8	2.36641	$200/(80 + 7 \times 169125/2^{18})$
9	2.34848	$200/(80 + 8 \times 169125/2^{18})$
10	2.33083	$200/(80 + 9 \times 169125/2^{18})$
11	2.31343	$200/(80 + 10 \times 169125/2^{18})$
12	2.29630	$200/(80 + 11 \times 169125/2^{18})$
13	2.27941	$200/(80 + 12 \times 169125/2^{18})$
14	2.26277	$200/(80 + 13 \times 169125/2^{18})$
15	2.24638	$200/(80 + 14 \times 169125/2^{18})$
16	2.23022	$200/(80 + 15 \times 169125/2^{18})$
17	2.21429	$200/(80 + 16 \times 169125/2^{18})$
18	2.19858	$200/(80 + 17 \times 169125/2^{18})$
19	2.18310	$200/(80 + 18 \times 169125/2^{18})$
20	2.16783	$200/(80 + 19 \times 169125/2^{18})$
21	2.15278	$200/(80 + 20 \times 169125/2^{18})$
22	2.13793	$200/(80 + 21 \times 169125/2^{18})$
23	2.12329	$200/(80 + 22 \times 169125/2^{18})$
24	2.10884	$200/(80 + 23 \times 169125/2^{18})$
25	2.09459	$200/(80 + 24 \times 169125/2^{18})$
26	2.08054	$200/(80 + 25 \times 169125/2^{18})$
27	2.06667	$200/(80 + 26 \times 169125/2^{18})$
28	2.05298	$200/(80 + 27 \times 169125/2^{18})$
29	2.03947	$200/(80 + 28 \times 169125/2^{18})$
30	2.02614	$200/(80 + 29 \times 169125/2^{18})$
31	2.01299	$200/(80 + 30 \times 169125/2^{18})$
32	2.00000	$200/(80 + 31 \times 169125/2^{18})$

Example 3. Dithered PMIC clock with slope in continuous mode

Objective: To configure a dithered PMIC clock at frequencies ranging from 2 MHz to 2.5 MHz over 100 μ s.

Configurations:

1. PMICCLK_SRC = 0x2 (600 MHz PLL divided clock)
2. SRCLOCK_DIV = 2, Reference clock = 600 MHz / (2 + 1) = 200 MHz
3. MODE_SELECT = 0
4. FREQ_SLOPE = 23302 (Computed as $(MAX_NDIV_VAL - MIN_NDIV_VAL) \cdot 2^{18} / (100 \mu s \cdot (2.5 \text{ MHz} + 2 \text{ MHz}) / 2)$)
5. MIN_NDIV_VAL = 80 (Computed as 200 MHz / 2.5 MHz)
6. MAX_NDIV_VAL = 100 (Computed as 200 MHz / 2.0 MHz)
7. CLK_DITHER_EN = 1

With the above configuration, the PMIC clock frequency would be PMIC clock would vary between = (200 MHz / 80) to (200 MHz / 100) in steps of $(200 \text{ MHz} / [(80 + (N \times 23302 / 2^{18} + X))])$ where

- N = Iteration count that ticks every PMIC clock. The average value of PMIC clock here is $\sim 2.25 \text{ MHz}$. Hence the iteration count ticks every $(1 / 2.25 \text{ MHz}) \sim 0.444 \mu$ s.
- X = random fractional value in the range (0, 1) that adds the dither

The PMIC clock frequency is determined by the clock divider which starts with a value of 100, on the 1st PMIC clock period, providing a PMIC clock of 2 MHz, decrementing the divider value by $23303 / 2^{18} = 0.08889$ every PMIC clock period of $1 / 2.25 \text{ MHz} \sim 0.444 \mu$ s, finally reaching a value of 80 on 225th PMIC clock period, providing a PMIC clock of 2.5 MHz. Hence, the frequency varies from [2 MHz, 2.5 MHz] over 225 PMIC clock periods or $225 \times 0.444 \mu$ s or $\sim 100 \mu$ s.

5.16.10 Sub block 0x4049 – AWR_MSS_PERIODICTESTS_CONF_SB

This sub block is used to trigger the periodic tests in MSS.

Table 5.124 describes the content of this sub block.

Table 5.124: AWR_MSS_PERIODICTESTS_CONF_SB contents

Field Name	Number of bytes	Description
SBLKID	2	Value = 0x4049
SBLKLEN	2	Value = 16

Continued on next page

Table 5.124 – continued from previous page

PERIODICITY	4	Periodicity at which tests need to be run 1 LSB = 1 ms Minimum value is 40 ms Maximum value is 150ms NOTE: MSS Windowed WDT period is set to this periodicity and WDT can not support period more than 150ms.
TEST_EN	4	1 – Enable, 0 – Disable Bit Monitoring type b0 PERIODIC_CONFIG_REGISTER_READ_EN b1 ESM_MONITORING_EN b31:2 RESERVED
REPORTING_MODE	1	Controls when the AWR device sends the report corresponding to the periodic tests to the host. A report generically refers to both success/failure status flags. Value Definition 0 Report is sent every monitoring period 1 Report is sent only on a failure
RESERVED	3	0x000000

NOTE: The MSS periodic monitor test run and latent tests are not recommended to run in parallel as latent tests are destructive tests which would cause periodic tests to fail.

5.16.11 Sub block 0x404A – AWR_MSS_LATENTFAULT_TEST_CONF_SB

This sub block is used to trigger the periodic latent fault tests in MSS, this API should not be issued when functional frames are running, these are destructive tests.

Table 5.125 describes the content of this sub block.

Table 5.125: AWR_MSS_LATENTFAULT_TEST_CONF_SB contents

Field Name	Number of bytes	Description
SBLKID	2	Value = 0x404A
SBLKLEN	2	Value = 16

Continued on next page

Table 5.125 – continued from previous page

TEST_EN_1	4	Bits	Definition
		b0	RESERVED
		b1	DMA self-test
		b2	RESERVED
		b3	RTI self-test
		b4	RESERVED
		b5	EDMA self-test
		b6	CRC self-test
		b7	VIM self-test
		b8	RESERVED
		b9	Mailbox self-test
		b10	RESERVED
		b11	RESERVED
		b12	Generating NERROR
		b13	MibSPI single bit error test
		b14	MibSPI double bit error test
		b15	DMA Parity error
		b16	TCMA RAM single bit errors (Not supported, refer latest release note)
		b17	TCMB RAM single bit errors (Not supported, refer latest release note)
		b18	TCMA RAM double bit errors (Not supported, refer latest release note)
		b19	TCMB RAM double bit errors (Not supported, refer latest release note)
		b20	TCMA RAM parity errors (Not supported, refer latest release note)
		b21	TCMB RAM parity errors (Not supported, refer latest release note)
		b22	RESERVED
		b23	RESERVED
		b24	DMA MPU Region tests
		b25	MSS Mailbox single bit errors
		b26	MSS Mailbox double bit errors
		b27	BSS Mailbox single bit errors
		b28	BSS Mailbox double bit errors
		b29	EDMA MPU test
		b30	EDMA parity test
		b31	CSI2 parity test

Continued on next page

Table 5.125 – continued from previous page

TEST_EN_2	4	Bits	Definition
		b0	RESERVED
		b1	RESERVED
		b2	RESERVED
		b3	VIM RAM parity test
		b4	SCI boot time test
		b31:5	RESERVED
REPORTING_MODE	1	Value	Definition
		0	Report is sent after test completion
		1	Report is send only upon a failure
TEST_MODE	1	Value	Definition
		0	Production mode. Latent faults are tested and any failures are reported
		1	Characterization mode. Faults are injected and failures are reported which allows testing of the failure reporting
RESERVED	2	0x0000	

NOTE1: The MSS latent self tests are destructive tests, which would cause corruption in ongoing SPI/mailbox transactions and may generate N-Error signals while performing ESM G2 error checks. The MIB-SPI ECC tests (b13,b14) can be destructive tests if there is an ongoing MIBSPI communication. It is recommended not to run these self tests in functional mode of operation.

NOTE2: It is recommended to wait for the latent fault test report asynchronous event after issuing this API. The MSS latent self tests cannot be issued back to back without waiting for the test report event.

5.16.12 Sub block 0x404B – AWR_DEV_TESTPATTERN_GEN_SET_SB

This sub block contains the configurations to setup the test pattern to be generated and transferred over the selected high speed interface (LVDS/CSI2). This command has to be issued after the data path configurations commands are issued. This can be used to perform a sanity test of the high speed interface connectivity and correct reception.

Table 5.126 describes the contents of this sub block.

Table 5.126: AWR_DEV_TESTPATTERN_GEN_SET_SB contents

Field Name	Number of bytes	Description															
SBLKID	2	Value = 0x404B															
SBLKLEN	2	Value = 48															
TESTPATTERN_GEN_CTRL	1	This field controls the enable-disable of the generation of the test pattern. Value Description 0x0 Disable test pattern generation 0x1 Enable test pattern generation															
TESTPATTERN_GEN_TIMING	1	Number of system clocks (200 MHz) between successive samples for the test pattern gen. Applicable only in case of Test pattern enable. Else ignored.															
TESTPATTERN_PKT_SIZE	2	Number of ADC samples to capture for each RX Valid range: 64 to MAX_NUM_SAMPLES, Where MAX_NUM_SAMPLES is such that all the enabled RX channels' data fits into 16 kB memory, with each sample consuming 2 bytes for real ADC output case and 4 bytes for complex 1x and complex 2x ADC output cases. For example in AWR1243/xWR1443 when the ADC buffer size is 16 kB <table border="1" style="margin-left: auto; margin-right: auto;"> <thead> <tr> <th>Number of RX chains</th> <th>ADC format</th> <th>MAX_NUM_SAMPLES</th> </tr> </thead> <tbody> <tr> <td>4</td> <td>Complex</td> <td>1024</td> </tr> <tr> <td>4</td> <td>Real</td> <td>2048</td> </tr> <tr> <td>2</td> <td>Complex</td> <td>2048</td> </tr> <tr> <td>2</td> <td>Real</td> <td>4096</td> </tr> </tbody> </table>	Number of RX chains	ADC format	MAX_NUM_SAMPLES	4	Complex	1024	4	Real	2048	2	Complex	2048	2	Real	4096
Number of RX chains	ADC format	MAX_NUM_SAMPLES															
4	Complex	1024															
4	Real	2048															
2	Complex	2048															
2	Real	4096															
NUM_TESTPATTERN_PKTS	4	Number of test pattern packets to send For infinite packets set it to 0															
TESTPATTERN_RX0_ICFG	4	This field specifies the values for Rx0, I channel. Applicable only in case of test pattern enable. Else ignored. Bits Description b15:0 Start offset value to be used for the first sample for the test pattern data b31:16 Value to be added for each successive sample for the test pattern data															

Continued on next page

Table 5.126 – continued from previous page

TESTPATTERN_ RX0_QCFG	4	<p>This field specifies the values for Rx0, Q channel. Applicable only in case of test pattern enable. Else ignored.</p> <p>Bits Description</p> <p>b15:0 Start offset value to be used for the first sample for the test pattern data</p> <p>b31:16 Value to be added for each successive sample for the test pattern data</p>
TESTPATTERN_ RX1_ICFG	4	<p>This field specifies the values for Rx1, I channel. Applicable only in case of test pattern enable. Else ignored.</p> <p>Bits Description</p> <p>b15:0 Start offset value to be used for the first sample for the test pattern data</p> <p>b31:16 Value to be added for each successive sample for the test pattern data</p>
TESTPATTERN_ RX1_QCFG	4	<p>This field specifies the values for Rx1, Q channel. Applicable only in case of test pattern enable. Else ignored.</p> <p>Bits Description</p> <p>b15:0 Start offset value to be used for the first sample for the test pattern data</p> <p>b31:16 Value to be added for each successive sample for the test pattern data</p>
TESTPATTERN_ RX2_ICFG	4	<p>This field specifies the values for Rx2, I channel. Applicable only in case of test pattern enable. Else ignored.</p> <p>Bits Description</p> <p>b15:0 Start offset value to be used for the first sample for the test pattern data</p> <p>b31:16 Value to be added for each successive sample for the test pattern data</p>
TESTPATTERN_ RX2_QCFG	4	<p>This field specifies the values for Rx2, Q channel. Applicable only in case of test pattern enable. Else ignored.</p> <p>Bits Description</p> <p>b15:0 Start offset value to be used for the first sample for the test pattern data</p> <p>b31:16 Value to be added for each successive sample for the test pattern data</p>

Continued on next page

Table 5.126 – continued from previous page

TESTPATTERN_ RX3_ICFG	4	This field specifies the values for Rx3, I channel. Applicable only in case of test pattern enable. Else ignored. Bits Description b15:0 Start offset value to be used for the first sample for the test pattern data b31:16 Value to be added for each successive sample for the test pattern data
TESTPATTERN_ RX3_QCFG	4	This field specifies the values for Rx3, Q channel. Applicable only in case of test pattern enable. Else ignored. Bits Description b15:0 Start offset value to be used for the first sample for the test pattern data b31:16 Value to be added for each successive sample for the test pattern data
RESERVED	4	0x00000000

NOTE: This test pattern can be used only in LVDS testing and bring-up

5.16.13 Sub block 0x404C – AWR_DEV_CONFIGURATION_SET_SB

This API is used to configure the CRC type for the async events from MSS. The default is 16 bit CRC if this API is not issued. The first async event after MSS powerup will have a 16 bit CRC.

Table 5.127: AWR_DEV_CONFIGURATION_SET_SB contents

Field Name	Number of bytes	Description
SBLKID	2	Value = 0x404C
SBLKLEN	2	Value = 16
ASYNC_EVENT_ CRC_CFG	1	Value Description 0 16 bit CRC for MSS async events 1 32 bit CRC for MSS async events 2 64 bit CRC for MSS async events
RESERVED1	1	0x00
RESERVED2	2	0x0000
RESERVED3	4	0x00000000
RESERVED4	4	0x00000000

5.17 Sub blocks related to AWR_DEV_CONF_GET_MSG

5.17.1 Sub block 0x4060 – AWR_DEV_MCUCLOCK_GET_SB

This API is used to read the MCU clock configuration. Response packet structure will be same as AWR_DEV_MCUCLOCK_SET_SB

Table 5.128: AWR_DEV_MCUCLOCK_GET_SB contents

Field Name	Number of bytes	Description
SBLKID	2	Value = 0x4060
SBLKLEN	2	Value = 4

5.17.2 Sub block 0x4061 – AWR_DEV_RX_DATA_FORMAT_CONF_GET_SB

This API is used to read the RX data format configuration. Response packet structure will be same as AWR_DEV_RX_DATA_FORMAT_CONF_SET_SB

Table 5.129: AWR_DEV_RX_DATA_FORMAT_CONF_GET_SB contents

Field Name	Number of bytes	Description
SBLKID	2	Value = 0x4061
SBLKLEN	2	Value = 4

5.17.3 Sub block 0x4062 – AWR_DEV_RX_DATA_PATH_CONF_GET_SB

This API is used to read the RX data path configuration. Response packet structure will be same as AWR_DEV_RX_DATA_PATH_CONF_SET_SB

Table 5.130: AWR_DEV_RX_DATA_PATH_CONF_GET_SB contents

Field Name	Number of bytes	Description
------------	-----------------	-------------

SBLKID	2	Value = 0x4062
SBLKLEN	2	Value = 4

5.17.4 Sub block 0x4063 – AWR_DEV_RX_DATA_PATH_LANEEN_GET_SB

This API is used to read the RX data path lane enable configuration. Response packet structure will be same as AWR_DEV_RX_DATA_PATH_LANEEN_SET_SB

Table 5.131: AWR_DEV_RX_DATA_PATH_LANEEN_GET_SB contents

Field Name	Number of bytes	Description
SBLKID	2	Value = 0x4063
SBLKLEN	2	Value = 4

5.17.5 Sub block 0x4064 – AWR_DEV_RX_DATA_PATH_CLK_GET_SB

This API is used to read the RX data path clock configuration. Response packet structure will be same as AWR_DEV_RX_DATA_PATH_CLK_SET_SB

Table 5.132: AWR_DEV_RX_DATA_PATH_CLK_GET_SB contents

Field Name	Number of bytes	Description
SBLKID	2	Value = 0x4064
SBLKLEN	2	Value = 4

5.17.6 Sub block 0x4065 – AWR_DEV_LVDS_CFG_GET_SB

This API is used to read the LVDS configuration. Response packet structure will be same as AWR_DEV_LVDS_CFG_SET_SB

Table 5.133: AWR_DEV_LVDS_CFG_GET_SB contents

Field Name	Number of bytes	Description
SBLKID	2	Value = 0x4065
SBLKLEN	2	Value = 4

5.17.7 Sub block 0x4066 – AWR_DEV_RX_CONTSTREAMING_MODE_CONF_GET_SB

This API is used to read the continuous streaming mode configuration. Response packet structure will be same as AWR_DEV_RX_CONTSTREAMING_MODE_CONF_SET_SB

Table 5.134: AWR_DEV_RX_CONTSTREAMING_CONF_GET_SB contents

Field Name	Number of bytes	Description
SBLKID	2	Value = 0x4066
SBLKLEN	2	Value = 4

5.17.8 Sub block 0x4067 – AWR_DEV_CSI2_CFG_GET_SB

This API is used to read the CSI2 configuration. Response packet structure will be same as AWR_DEV_CSI2_CFG_SET_SB

Table 5.135: AWR_DEV_CSI2_CFG_GET_SB contents

Field Name	Number of bytes	Description
SBLKID	2	Value = 0x4067
SBLKLEN	2	Value = 4

5.17.9 Sub block 0x4068 – AWR_DEV_PMICCLOCK_CONF_GET_SB

This API is used to read the PMIC clock configuration. Response packet structure will be same as AWR_DEV_PMICCLOCK_CONF_SET_SB

Table 5.136: AWR_DEV_PMICCLOCK_CONF_GET_SB contents

Field Name	Number of bytes	Description
SBLKID	2	Value = 0x4068
SBLKLEN	2	Value = 4

5.17.10 Sub block 0x4069 – AWR_MSS_LATENTFAULT_TEST_CONF_GET_SB

This API is used to read the MSS latent fault test configuration. Response packet structure will be same as AWR_MSS_LATENTFAULT_TEST_CONF_SET_SB

Table 5.137: AWR_MSS_LATENTFAULT_CONF_GET_SB contents

Field Name	Number of bytes	Description
------------	-----------------	-------------

SBLKID	2	Value = 0x4069
SBLKLEN	2	Value = 4

5.17.11 Sub block 0x406A – AWR_MSS_PERIODICTESTS_CONF_GET_SB

This API is used to read the MSS periodic tests configuration. Response packet structure will be same as AWR_MSS_PERIODICTESTS_CONF_SET_SB

Table 5.138: AWR_MSS_PERIODICTESTS_CONF_GET_SB contents

Field Name	Number of bytes	Description
SBLKID	2	Value = 0x406A
SBLKLEN	2	Value = 4

5.17.12 Sub block 0x406B – AWR_DEV_TESTPATTERN_GEN_GET_SB

This API is used to read the test pattern generation configuration. Response packet structure will be same as AWR_DEV_TESTPATTERN_GEN_SET_SB

Table 5.139: AWR_DEV_TESTPATTERN_GEN_GET_SB contents

Field Name	Number of bytes	Description
SBLKID	2	Value = 0x406B
SBLKLEN	2	Value = 4

5.18 Sub blocks related to AWR_DEV_FILE_DOWNLOAD_MSG

5.18.1 Sub block 0x4080 – AWR_DEV_FILE_DOWNLOAD_SB

This sub block is used to send the file in chunks/parts for download into RAM. Table 5.140 describes the content of this sub block.

Table 5.140: AWR_DEV_FILE_DOWNLOAD_SB contents

Field Name	Number of bytes	Description
SBLKID	2	Value = 0x4080
SBLKLEN	2	Value = Variable

Continued on next page

Table 5.140 – continued from previous page

FILE_TYPE	4	Value	Description
		0x0	RESERVED
		0x1	RESERVED
		0x2	RESERVED
		0x3	RESERVED
		0x4	META_IMAGE1 TO SFLASH
		0x5	META_IMAGE2 TO SFLASH
		0x6	META_IMAGE3 TO SFLASH
0x7	META_IMAGE4 TO SFLASH		
FILE_LENGTH	4	Length of File	
FILE_CONTENT	Variable	Content of File, may split into multiple chunks.	

NOTE: In the first chunk of file, FILE_TYPE and FILE_LENGTH is available and then first chunk onward these two fields will not be part of SB content

5.19 Sub blocks related to AWR_DEV_FRAME_CONFIG_APPLY_MSG

5.19.1 Sub block 0x40C0 – AWR_DEV_FRAME_CONFIG_APPLY_SB

This sub block is used to indicate to MSS to apply all the device configurations in the hardware. This API should be used when legacy frame config is used.

Table 5.141 describes the content of this sub block.

Table 5.141: AWR_DEV_FRAME_CONFIG_APPLY_SB contents

Field Name	Number of bytes	Description
SBLKID	2	Value = 0x40C0
SBLKLEN	2	Value = 12
NUM_CHIRPS	4	Number of chirps per frame
HALF_WORDS_PER_CHIRP	2	Number of half words in ADC buffer per chirp Example 1: In real mode, if number of ADC samples per chirp is 256 then this value will be 256 Example 2: In complex1x or complex2x modes, if number of ADC samples per chirp is 256 then this value will be 512
RESERVED	2	0x0000

5.19.2 Sub block 0x40C1 – AWR_DEV_ADV_FRAME_CONFIG_APPLY_SB

This sub block is used to indicate to MSS to apply all the advanced frame configuration settings in the hardware. This API should be used when advance frame config is used.

Table 5.142 describes the content of this sub block.

Table 5.142: AWR_DEV_ADV_FRAME_CONFIG_APPLY_SB contents

Field Name	Number of bytes	Description
SBLKID	2	Value = 0x40C1
SBLKLEN	2	Value = 40
NUM_SUB-FRAMES	1	Number of sub frames enabled in this frame Valid range: 1 to 4
RESERVED	3	0x00
SF1_TOT_NUM_CHIRPS	4	Number of chirps in sub frame 1
SF1_NUM_ADC_SAMPLES_PER_DATA_PKT	2	<p>Number of half words (16 bits) of ADC samples per data packet in sub-frame 1</p> <p>Example 1: In real mode, if number of ADC samples per chirp in subframe1 is 256 then this value will be 256</p> <p>Example 2: In complex1x or complex2x modes, if number of ADC samples per chirp in subframe1 is 256 then this value will be 512</p> <p>In AWR1243/xWR1443: Program this as the same as number of ADC samples in each chirp of this sub frame (required to be the same)</p> <p>Exception: Can do #chirps based ping-pong as in xWR1642 (see below), if CP/CQ are not needed. Useful for chirp stitching use case.</p> <p>In xWR1642/xWR1843 (For reference Only): The ADC samples corresponding to one or more chirps can be grouped and sent to the DSP as a single packet. Program this as the number of half words of ADC samples per packet. Ensure that in one sub frame, there is integer number of such packets.</p> <p>Maximum size of a data packet: (16384 - 1) half words.</p>

Continued on next page

Table 5.142 – continued from previous page

SF1_PROC_NUM_CHIRPS_PER_DATA_PKT	1	Number of chirps per data packet to process at a time in sub-frame 1. In AWR1243/xWR1443: Program this as 1. Exception: Can be > 1 as in 1642 if CP/CQ is not needed. Useful for chirp stitching use case. In xWR1642/xWR1843 (For reference Only): The ADC samples corresponding to one or more chirps can be grouped and sent to the DSP as a single packet. Program this as the corresponding number of chirps per packet. Maximum value = 8. Note on maximum size: 8 chirps for CP and BPM.
RESERVED	1	0x00
SF2_TOT_NUM_CHIRPS	4	Number of chirps in sub-frame 2
SF2_NUM_ADC_SAMPLES_PER_DATA_PKT	2	Number of ADC Samples per data packet in sub-frame 2 Same conditions apply as in sub-frame 1.
SF2_PROC_NUM_CHIRPS_PER_DATA_PKT	1	Number of chirps per data packet to process at a time in sub-frame 2 Same conditions apply as in sub-frame 1.
RESERVED	1	0x00
SF3_TOT_NUM_CHIRPS	4	Number of chirps in sub-frame3
SF3_NUM_ADC_SAMPLES_PER_DATA_PKT	2	Number of ADC samples per data packet in sub-frame 3 Same conditions apply as in sub-frame 1.
SF3_PROC_NUM_CHIRPS_PER_DATA_PKT	1	Number of chirps per data packet to process at a time in sub-frame 3 Same conditions apply as in sub-frame 1.
RESERVED	1	0x00
SF4_TOT_NUM_CHIRPS	4	Number of chirps in sub-frame4
SF4_NUM_ADC_SAMPLES_PER_DATA_PKT	2	Number of ADC samples per data packet in sub-frame 4 Same conditions apply as in sub-frame 1.
SF4_PROC_NUM_CHIRPS_PER_DATA_PKT	1	Number of chirps per data packet to process at a time in sub-frame 4 Same conditions apply as in sub-frame 1.
RESERVED	1	0x00

5.20 Sub blocks related to AWR_DEV_STATUS_GET_MSG

5.20.1 Sub block 0x40E0 – AWR_MSSVERSION_GET_SB

This sub block reads MSS FW version. The information returned by the device will be in the format as given in AWR_MSSVERSION_SB.

Table 5.143 describes the contents of the request sub block

Table 5.143: AWR_MSSVERSION_GET_SB contents

Field Name	Number of bytes	Description
SBLKID	2	Value = 0x40E0
SBLKLEN	2	Value = 4

Response to AWR_MSSVERSION_GET_SB

AWR_MSSVERSION_SB sub block is sent by the radar device in response to AWR_MSSVERSION_GET_SB. Note that SBLKID for both AWR_MSSVERSION_GET_SB and AWR_MSSVERSION_SB are same.

Table 5.144 describes the contents of the response sub block.

Table 5.144: AWR_MSSVERSION_SB contents

Field Name	Number of bytes	Description
SBLKID	2	Value = 0x40E0
SBLKLEN	2	Value = 20
HW_VARIANT	1	HW variant number
HW_VERSION_MAJOR	1	HW version major number
HW_VERSION_MINOR	1	HW version minor number
MSS_FW_VERSION_MAJOR	1	MSS FW version major number
MSS_FW_VERSION_MINOR	1	MSS FW version minor number
MSS_FW_VERSION_BUILD	1	MSS FW version build number
MSS_FW_VERSION_DEBUG	1	MSS FW version debug number
MSS_FW_VERSION_YEAR	1	Year of MSS FW version release

Continued on next page

Table 5.144 – continued from previous page

MSS_FW_VERSION_MONTH	1	Month of MSS FW version release						
MSS_FW_VERSION_DAY	1	Day of MSS FW version release						
MSS_FW_VERSION_PATCH_MAJOR	1	MSS FW version patch major number						
MSS_FW_VERSION_PATCH_MINOR	1	MSS FW version patch minor number						
MSS_FW_VERSION_PATCH_YEAR	1	Year of MSS FW patch release						
MSS_FW_VERSION_PATCH_MONTH	1	Month of MSS FW patch release						
MSS_FW_VERSION_PATCH_DAY	1	Day of MSS FW patch release						
MSS_FW_PATCH_BUILD_DEBUG_VERSION	1	<table border="0"> <tr> <td>Bit</td> <td>Definition</td> </tr> <tr> <td>b3:0</td> <td>DEBUG version number</td> </tr> <tr> <td>b7:4</td> <td>BUILD version number</td> </tr> </table>	Bit	Definition	b3:0	DEBUG version number	b7:4	BUILD version number
Bit	Definition							
b3:0	DEBUG version number							
b7:4	BUILD version number							

5.20.2 Sub block 0x40E1 – AWR_MSSCPUFAULT_STATUS_GET_SB

This sub block provides the MSS CPU fault information.

Table 5.145 describes the content of this sub block.

Table 5.145: AWR_MSSVERSION_SB contents

Field Name	Number of bytes	Description
SBLKID	2	Value = 0x40E1
SBLKLEN	2	Value = 4

Response to AWR_MSSCPUFAULT_STATUS_GET_SB

AWR_MSSCPUFAULT_STATUS_SB is sent in response to AWR_MSSCPUFAULT_STATUS_GET_SB.

Table 5.146 describes the content of AWR_MSSCPUFAULT_STATUS_SB

Table 5.146: AWR_MSSCPFAULT_STATUS_SB contents

Field Name	Number of bytes	Description																		
SBLKID	2	Value = 0x40E1																		
SBLKLEN	2	Value = 36																		
FAULT_TYPE	1	<table border="0"> <tr> <td>Value</td> <td>Definition</td> </tr> <tr> <td>0</td> <td>MSS Processor Undefined Instruction Abort</td> </tr> <tr> <td>1</td> <td>MSS Processor Instruction pre-fetch Abort</td> </tr> <tr> <td>2</td> <td>MSS Processor Data Access Abort</td> </tr> <tr> <td>3</td> <td>MSS Processor Firmware Fatal Error</td> </tr> <tr> <td>0x4-0xFF</td> <td>Reserved</td> </tr> </table>	Value	Definition	0	MSS Processor Undefined Instruction Abort	1	MSS Processor Instruction pre-fetch Abort	2	MSS Processor Data Access Abort	3	MSS Processor Firmware Fatal Error	0x4-0xFF	Reserved						
Value	Definition																			
0	MSS Processor Undefined Instruction Abort																			
1	MSS Processor Instruction pre-fetch Abort																			
2	MSS Processor Data Access Abort																			
3	MSS Processor Firmware Fatal Error																			
0x4-0xFF	Reserved																			
RESERVED	1	0x00																		
LINE_NUM	2	Valid only in case of FAULT type is 0x3, provides the firmware line number at which fatal error occurred.																		
FAULT_LR	4	The instruction PC address at which Fault occurred																		
FAULT_PREV_LR	4	The return address of the function from which fault function has been called (Call stack LR)																		
FAULT_SPSR	4	The CPSR register value at which fault occurred																		
FAULT_SP	4	The SP register value at which fault occurred																		
FAULT_CAUSE_ADDRESS	4	The address access at which Fault occurred (valid only for fault type 0x0 to 0x2)																		
FAULT_ERROR_STATUS	2	<table border="0"> <tr> <td colspan="2">The status of Error (Error Cause type - valid only for fault type 0x0 to 0x2)</td> </tr> <tr> <td>0x000</td> <td>BACKGROUND_ERR</td> </tr> <tr> <td>0x001</td> <td>ALIGNMENT_ERR</td> </tr> <tr> <td>0x002</td> <td>DEBUG_EVENT</td> </tr> <tr> <td>0x00D</td> <td>PERMISSION_ERR</td> </tr> <tr> <td>0x008</td> <td>SYNCH_EXTER_ERR</td> </tr> <tr> <td>0x406</td> <td>ASYNCH_EXTER_ERR</td> </tr> <tr> <td>0x409</td> <td>SYNCH_ECC_ERR</td> </tr> <tr> <td>0x408</td> <td>ASYNCH_ECC_ERR</td> </tr> </table>	The status of Error (Error Cause type - valid only for fault type 0x0 to 0x2)		0x000	BACKGROUND_ERR	0x001	ALIGNMENT_ERR	0x002	DEBUG_EVENT	0x00D	PERMISSION_ERR	0x008	SYNCH_EXTER_ERR	0x406	ASYNCH_EXTER_ERR	0x409	SYNCH_ECC_ERR	0x408	ASYNCH_ECC_ERR
The status of Error (Error Cause type - valid only for fault type 0x0 to 0x2)																				
0x000	BACKGROUND_ERR																			
0x001	ALIGNMENT_ERR																			
0x002	DEBUG_EVENT																			
0x00D	PERMISSION_ERR																			
0x008	SYNCH_EXTER_ERR																			
0x406	ASYNCH_EXTER_ERR																			
0x409	SYNCH_ECC_ERR																			
0x408	ASYNCH_ECC_ERR																			
FAULT_ERROR_SOURCE	1	<table border="0"> <tr> <td colspan="2">The Source of the Error (Error Source type - valid only for fault type 0x0 to 0x2)</td> </tr> <tr> <td>0x0</td> <td>ERR_SOURCE_AXI_MASTER</td> </tr> <tr> <td>0x1</td> <td>ERR_SOURCE_ATCM</td> </tr> <tr> <td>0x2</td> <td>ERR_SOURCE_BTCM</td> </tr> </table>	The Source of the Error (Error Source type - valid only for fault type 0x0 to 0x2)		0x0	ERR_SOURCE_AXI_MASTER	0x1	ERR_SOURCE_ATCM	0x2	ERR_SOURCE_BTCM										
The Source of the Error (Error Source type - valid only for fault type 0x0 to 0x2)																				
0x0	ERR_SOURCE_AXI_MASTER																			
0x1	ERR_SOURCE_ATCM																			
0x2	ERR_SOURCE_BTCM																			

Continued on next page

Table 5.146 – continued from previous page

FAULT_AXI_ERROR_TYPE	1	The AXI Error type (Error Source type - valid only for fault type 0x0 to 0x2) 0x0 AXI_DECOD_ERR 0x1 AXI_SLAVE_ERR
FAULT_ACCESS_TYPE	1	The Error Access type (Error Access type - valid only for fault type 0x0 to 0x2) 0x0 READ_ERR 0x1 WRITE_ERR
FAULT_RECOVERY_TYPE	1	The Error Recovery type (Error Recovery type - Valid only for fault type 0x0 to 0x2) 0x0 UNRECOVERY 0x1 RECOVERY
RESERVED	2	0x0000

5.20.3 Sub block 0x40E2 – AWR_MSESMFAULT_STATUS_GET_SB

This sub block provides the information regarding additional Master sub system faults. Table 5.147 describes the content of this sub block.

Table 5.147: AWR_MSESMFAULT_STATUS_GET_SB contents

Field Name	Number of bytes	Description
SBLKID	2	Value = 0x40E2
SBLKLEN	2	Value = 4

The Response to above request is given in the AWR_MSESMFAULT_STATUS_SB. Table 5.148 describes the contents of AWR_MSESMFAULT_STATUS_SB.

Table 5.148: AWR_MSESMFAULT_STATUS_SB contents

Field Name	Number of bytes	Description
SBLKID	2	Value = 0x40E2
SBLKLEN	2	Value = 20

Continued on next page

Table 5.148 – continued from previous page

ESM_GROUP1_ ERRORS	4	Bits	Definition
		b0	NERROR in sync
		b1	RESERVED
		b2	DMA MPU Region tests
		b3	DMA Parity error
		b4	RESERVED
		b5	RESERVED
		b6	DSS CSI parity Error
		b7	TPCC parity error
		b8	CBUF ECC single bit error
		b9	CBUF ECC double bit error
		b10	RESERVED
		b11	RESERVED
		b12	RESERVED
		b13	Error response from the Peripheral when a DMA transfer is done
		b14	RESERVED
		b15	VIM RAM double bit errors
		b16	RESERVED
		b17	MibSPI double bit error test
		b18	DSS TPTC0 read MPU error
		b19	RESERVED
		b20	VIM RAM single bit errors
		b21	RESERVED
		b22	FRC Lock Step Error
		b23	RESERVED
		b24	RESERVED
		b25	MibSPI single bit error test
		b26	TCMB0 RAM single bit errors
		b27	STC error
		b28	TCMB1 RAM single bit errors
		b29	DSS TPTC0 write MPU error
		b30	DCC compare error
		b31	CR4F self-test error.(test of error path by error forcing)

Continued on next page

Table 5.148 – continued from previous page

ESM_GROUP2_ ERRORS	4	Bits	Definition
		b0	TCMA RAM single bit errors
		b1	RESERVED
		b2	RESERVED
		b3	DSS TPTC1 read MPU error
		b4	DSS TPTC1 write MPU error
		b5	RESERVED
		b6	Access error interrupt from FFT ACC
		b7	VIM Self-Test Error
		b8	RESERVED
		b9	RESERVED
		b10	RESERVED
		b11	RESERVED
		b12	RESERVED
		b13	RESERVED
		b14	RESERVED
		b15	RESERVED
		b16	RESERVED
		b17	RESERVED
		b18	RESERVED
		b19	RESERVED
		b20	RESERVED
		b21	RESERVED
		b22	RESERVED
		b23	RESERVED
		b24	RESERVED
		b25	BSS to MSS ESM G2 Trigger
		b26	BSS Mailbox single bit errors
		b27	BSS Mailbox double bit errors
		b28	MSS Mailbox single bit errors
		b29	MSS Mailbox double bit errors
		b30	RESERVED
b31	RESERVED		
RESERVED	4	0x00000000	
RESERVED	4	0x00000000	

5.21 Sub blocks related to AWR_DEV_ASYNC_EVENT_MSG

5.21.1 Sub block 0x5000 – AWR_AE_DEV_MSSPOWERUPDONE_SB

This sub block indicates that Master SS power up is now complete. It also indicates the status of boot up tests done by Master SS. This async event is sent when host IRQ is enabled.

Table 5.149 describes the contents of this sub block

Table 5.149: AWR_AE_DEV_MSSPOWERUPDONE_SB contents

Field Name	Number of bytes	Description
SBLKID	2	Value = 0x5000
SBLKLEN	2	Value = 24
MSS_POWERUP_TIME	4	Master SS power up time 1 LSB = 5 ns
MSS_POWERUP_STATUS	8	Refer to Table 7.3 for bit map details

Continued on next page

Table 5.149 – continued from previous page

BOOTTEST_ STATUS	8	0 – PASS, 1 – FAIL
		Bit Definition
		b0 MibSPI self-test
		b1 DMA self-test
		b2 RESERVED
		b3 RTI self-test
		b4 ESM self-test
		b5 EDMA self-test
		b6 CRC self-test
		b7 VIM self-test
		b8 MPU self-test
		b9 Mailbox self-test
		b10 RESERVED
		b11 RESERVED
		b12 RESERVED
		b13 MibSPI single bit error test
		b14 MibSPI double bit error test
		b15 DMA Parity error test
		b16 TCMA Single bit error test
		b17 TCMB Single bit error test
		b18 RESERVED
		b19 RESERVED
		b20 RESERVED
		b21 RESERVED
		b22 VIM lockstep test
		b23 CCM R4 lockstep test
		b24 DMA MPU region test
		b25 MSS Mailbox single bit error test
		b26 MSS Mailbox double bit error test
		b27 BSS Mailbox single bit error test
		b28 BSS Mailbox double bit error test
		b29 EDMA MPU test
		b30 EDMA parity test
		b31 RESERVED
		b32 RESERVED
		b33 RESERVED
		b34 PCR test
		b35 VIM RAM parity test
		b36 SCI boot time test
		b63:37 RESERVED

Table 5.149 – continued from previous page

NOTE:	The functional APIs shall be sent to radar device only after receiving AWR_AE_DEV_MSSPOWERUPDONE_SB Async-event after power cycle.
--------------	------------------------------------------------------------------------------------------------------------------------------------

5.21.2 Sub block 0x5001 – AWR_AE_DEV_RFPOWERUPDONE_SB

This sub block indicates that BIST SS power up is now complete.

Table 5.150 describes the contents of this sub block

Table 5.150: AWR_AE_DEV_RFPOWERUPDONE_SB contents

Field Name	Number of bytes	Description
SBLKID	2	Value = 0x5001
SBLKLEN	2	Value = 20

Continued on next page

Table 5.150 – continued from previous page

BSS_ POWERUP_ BIST_STATUS_ FLAGS	4	1 – PASS, 0 – FAIL Bit Status Information b0 ROM CRC check b1 CR4 and VIM lockstep test b2 RESERVED b3 VIM test (Not supported in 1st Gen devices, refer latest release note) b4 STC test of diagnostic b5 CR4 STC b6 CRC test b7 RAMPGEN memory ECC test b8 DFE Parity test b9 DFE memory ECC b10 RAMPGEN lockstep test b11 FRC lockstep test b12 DFE memory PBIST b13 RAMPGEN memory PBIST b14 PBIST test b15 WDT test b16 ESM test b17 DFE STC b18 RESERVED b19 ATCM, BTCM ECC test b20 ATCM, BTCM parity test b21 RESERVED b22 RESERVED b23 RESERVED b24 FFT test b25 RTI test b26 PCR test b31:27 RESERVED
POWERUP_ TIME	4	RF BIST SS Power up time 1 LSB = 5 ns
RESERVED	4	0x00000000
RESERVED	4	0x00000000

5.21.3 Sub block 0x5002 – AWR_AE_MSS_CPUFAULT_SB

This sub block indicates CPU fault status of Master SS.

Table 5.151 describes the content of this sub block.

Table 5.151: AWR_AE_MSS_CPUFAULT_STATUS_SB contents

Field Name	Number of bytes	Description
SBLKID	2	Value = 0x5002
SBLKLEN	2	Value = 36
FAULT_TYPE	1	0 MSS Processor Undefined Instruction Abort 1 MSS Processor Instruction pre-fetch Abort 2 MSS Processor Data Access Abort 3 MSS Processor Firmware Fatal Error 0x4-0xFF Reserved
RESERVED	1	0x00
LINE_NUM	2	Valid only in case of FAULT type is 0x3, provides the firmware line number at which fatal error occurred.
FAULT_LR	4	The instruction PC address at which Fault occurred
FAULT_PREV_LR	4	The return address of the function from which fault function has been called (Call stack LR)
FAULT_SPSR	4	The CPSR register value at which fault occurred
FAULT_SP	4	The SP register value at which fault occurred
FAULT_CAUSE_ADDRESS	4	The address access at which Fault occurred (valid only for fault type 0x0 to 0x2)
FAULT_ERROR_STATUS	2	The status of Error (Error Cause type - valid only for fault type 0x0 to 0x2) 0x000 BACKGROUND_ERR 0x001 ALIGNMENT_ERR 0x002 DEBUG_EVENT 0x00D PERMISSION_ERR 0x008 SYNCH_EXTER_ERR 0x406 ASYNCH_EXTER_ERR 0x409 SYNCH_ECC_ERR 0x408 ASYNCH_ECC_ERR

Continued on next page

Table 5.151 – continued from previous page

FAULT_ERROR_SOURCE	1	The Source of the Error (Error Source type - valid only for fault type 0x0 to 0x2) 0x0 ERR_SOURCE_AXI_MASTER 0x1 ERR_SOURCE_ATCM 0x2 ERR_SOURCE_BTCM
FAULT_AXI_ERROR_TYPE	1	The AXI Error type (Error Source type - valid only for fault type 0x0 to 0x2) 0x0 AXI_DECOD_ERR 0x1 AXI_SLAVE_ERR
FAULT_ACCESS_TYPE	1	The Error Access type (Error Access type - valid only for fault type 0x0 to 0x2) 0x0 READ_ERR 0x1 WRITE_ERR
FAULT_RECOVERY_TYPE	1	The Error Recovery type (Error Recovery type - Valid only for fault type 0x0 to 0x2) 0x0 UNRECOVERY 0x1 RECOVERY
RESERVED	2	0x0000

5.21.4 Sub block 0x5003 – AWR_AE_MSS_ESMFAULT_STATUS_SB

This sub block indicates any other faults inside the MSS.

Table 5.152 describes the content of this sub block.

Table 5.152: AWR_AE_MSS_ESMFAULT_STATUS_SB contents

Field Name	Number of bytes	Description
SBLKID	2	Value = 0x5003
SBLKLEN	2	Value = 20

Continued on next page

Table 5.152 – continued from previous page

ESM_GROUP1_ ERRORS	4	Bits	Definition
		b0	NERROR in sync
		b1	RESERVED
		b2	DMA MPU Region tests
		b3	DMA Parity error
		b4	RESERVED
		b5	RESERVED
		b6	DSS CSI parity Error
		b7	TPCC parity error
		b8	CBUF ECC single bit error
		b9	CBUF ECC double bit error
		b10	RESERVED
		b11	RESERVED
		b12	RESERVED
		b13	Error response from the Peripheral when a DMA transfer is done
		b14	RESERVED
		b15	VIM RAM double bit errors
		b16	RESERVED
		b17	MibSPI double bit error test
		b18	DSS TPTC0 read MPU error
		b19	RESERVED
		b20	VIM RAM single bit errors
		b21	RESERVED
		b22	FRC Lock Step Error
		b23	RESERVED
		b24	RESERVED
		b25	MibSPI single bit error test
		b26	TCMB0 RAM single bit errors
		b27	STC error
		b28	TCMB1 RAM single bit errors
		b29	DSS TPTC0 write MPU error
		b30	DCC compare error
		b31	CR4F self-test error.(test of error path by error forcing)

Continued on next page

Table 5.152 – continued from previous page

ESM_GROUP2_ ERRORS	4	Bits	Definition
		b0	TCMA RAM single bit errors
		b1	RESERVED
		b2	RESERVED
		b3	DSS TPTC1 read MPU error
		b4	DSS TPTC1 write MPU error
		b5	RESERVED
		b6	Access error interrupt from FFT ACC
		b7	VIM Self-Test Error
		b8	RESERVED
		b9	RESERVED
		b10	RESERVED
		b11	RESERVED
		b12	RESERVED
		b13	RESERVED
		b14	RESERVED
		b15	RESERVED
		b16	RESERVED
		b17	RESERVED
		b18	RESERVED
		b19	RESERVED
		b20	RESERVED
		b21	RESERVED
		b22	RESERVED
		b23	RESERVED
		b24	RESERVED
		b25	BSS to MSS ESM G2 Trigger
		b26	BSS Mailbox single bit errors
		b27	BSS Mailbox double bit errors
		b28	MSS Mailbox single bit errors
		b29	MSS Mailbox double bit errors
		b30	RESERVED
b31	RESERVED		
RESERVED	4	0x00000000	
RESERVED	4	0x00000000	

NOTE: The FRC lockstep fatal error is connected to MSS ESM Group 1 lines, This fatal error must be handled in Host in AWR1243 device (MSS or DSS in xWR1642, xWR1843 and xWR6843 devices)

5.21.5 Sub block 0x5004 – RESERVED

5.21.6 Sub block 0x5005 – AWR_AE_MSS_BOOTERRORSTATUS_SB

This sub block indicates error status of MSS when booted over SPI. This async event is sent after the bootup over SPI is complete.

Table 5.153 describes the content of this sub block.

Table 5.153: AWR_AE_MSS_BOOTERRORSTATUS_SB contents

Field Name	Number of bytes	Description
SBLKID	2	Value = 0x5005
SBLKLEN	2	Value = 24
MSS_POWERUP_TIME	4	Master SS power up time 1 LSB = 5 ns
MSS_POWERUP_STATUS	8	Refer to Table 7.3 for bit map details

Continued on next page

Table 5.153 – continued from previous page

BOOTTEST_ STATUS	8	0 – PASS, 1 – FAIL
		Bit Definition
		b0 MibSPI self-test
		b1 DMA self-test
		b2 RESERVED
		b3 RTI self-test
		b4 ESM self-test
		b5 EDMA self-test
		b6 CRC self-test
		b7 VIM self-test
		b8 MPU self-test
		b9 Mailbox self-test
		b10 RESERVED
		b11 RESERVED
		b12 RESERVED
		b13 MibSPI single bit error test
		b14 MibSPI double bit error test
		b15 DMA Parity error test
		b16 TCMA Single bit error test
		b17 TCMB Single bit error test
		b18 RESERVED
		b19 RESERVED
		b20 RESERVED
		b21 RESERVED
		b22 VIM lockstep test
		b23 CCM R4 lockstep test
		b24 DMA MPU region test
		b25 MSS Mailbox single bit error test
		b26 MSS Mailbox double bit error test
		b27 BSS Mailbox single bit error test
		b28 BSS Mailbox double bit error test
		b29 EDMA MPU test
		b30 EDMA parity test
		b31 RESERVED
		b32 RESERVED
		b33 RESERVED
		b34 PCR test
		b35 VIM RAM parity test
		b36 SCI boot time test
		b63:37 RESERVED

Table 5.153 – continued from previous page

NOTE:	The functional APIs shall be sent to radar device only after receiving AWR_AE_MSS_BOOTERRORSTATUS_SB Async-event after power-cycle.
--------------	-------------------------------------------------------------------------------------------------------------------------------------

5.21.7 Sub block 0x5006 – AWR_AE_MSS_LATENTFAULT_TESTREPORT_SB

This sub block indicates the test status report of the latent fault tests.

Table 5.154 describes the content of this sub block.

Table 5.154: AWR_AE_MSS_LATENTFAULT_TESTREPORT_SB contents

Field Name	Number of bytes	Description
SBLKID	2	Value = 0x5006
SBLKLEN	2	Value = 16

Continued on next page

Table 5.154 – continued from previous page

TEST_STATUS_FLAG1	4	1 – PASS, 0 - FAIL
		Bits Definition
		b0 RESERVED
		b1 DMA self-test
		b2 RESERVED
		b3 RTI self-test
		b4 RESERVED
		b5 EDMA self-test
		b6 CRC self-test
		b7 VIM self-test
		b8 RESERVED
		b9 Mailbox self-test
		b10 RESERVED
		b11 RESERVED
		b12 Generating NERROR
		b13 MibSPI single bit error test
		b14 MibSPI double bit error test
		b15 DMA Parity error
		b16 TCMA RAM single bit errors (Not supported, refer latest release note)
		b17 TCMB RAM single bit errors (Not supported, refer latest release note)
		b18 TCMA RAM double bit errors (Not supported, refer latest release note)
		b19 TCMB RAM double bit errors (Not supported, refer latest release note)
		b20 TCMA RAM parity errors (Not supported, refer latest release note)
		b21 TCMB RAM parity errors (Not supported, refer latest release note)
		b22 RESERVED
		b23 RESERVED
		b24 DMA MPU Region tests
		b25 MSS Mailbox single bit errors
		b26 MSS Mailbox double bit errors
		b27 BSS Mailbox single bit errors
		b28 BSS Mailbox double bit errors
		b29 EDMA MPU test
		b30 EDMA parity test
		b31 CSI2 parity test

Continued on next page

Table 5.154 – continued from previous page

TEST_STATUS_ FLAG2	4	Bits	Definition
		b0	RESERVED
		b1	RESERVED
		b2	RESERVED
		b3	VIM RAM parity test
		b4	SCI boot time test
		b31:5	RESERVED
RESERVED	4	0x00000000	

5.21.8 Sub block 0x5007 – AWR_AE_MSS_PERIODICTEST_STATUS_SB

This sub block indicates test status of the periodic tests.

Table 5.155 describes the content of this sub block.

Table 5.155: AWR_AE_MSS_PERIODICTEST_STATUS_SB contents

Field Name	Number of bytes	Description
SBLKID	2	Value = 0x5007
SBLKLEN	2	Value = 12
TEST_STATUS_ FLAG	4	1 – PASS, 0 – FAIL Bits Definition b0 Periodic read back of static registers b1 ESM self-test b31:2 RESERVED
RESERVED	4	0x00000000

5.21.9 Sub block 0x5008 – AWR_AE_MSS_RFERROR_STATUS_SB

This sub block indicates the RF error status.

Table 5.156 describes the content of this sub block.

Table 5.156: AWR_AE_MSS_RFERROR_STATUS_SB contents

Field Name	Number of bytes	Description
SBLKID	2	Value = 0x5008

Continued on next page

Table 5.156 – continued from previous page

SBLKLEN	2	Value = 12																		
ERROR_STATUS_FLAG	4	<table> <tr> <th>Value</th> <th>Definition</th> </tr> <tr> <td>0</td> <td>No fault</td> </tr> <tr> <td>1</td> <td>BSS FW assert</td> </tr> <tr> <td>2</td> <td>BSS FW abort</td> </tr> <tr> <td>3</td> <td>BSS ESM GROUP1 ERROR</td> </tr> <tr> <td>4</td> <td>BSS ESM GROUP2 ERROR</td> </tr> <tr> <td>6-5</td> <td>RESERVED</td> </tr> <tr> <td>7</td> <td>BSS monitoring failure in Mode 1(Quiet mode)</td> </tr> <tr> <td>Others</td> <td>RESERVED</td> </tr> </table>	Value	Definition	0	No fault	1	BSS FW assert	2	BSS FW abort	3	BSS ESM GROUP1 ERROR	4	BSS ESM GROUP2 ERROR	6-5	RESERVED	7	BSS monitoring failure in Mode 1(Quiet mode)	Others	RESERVED
Value	Definition																			
0	No fault																			
1	BSS FW assert																			
2	BSS FW abort																			
3	BSS ESM GROUP1 ERROR																			
4	BSS ESM GROUP2 ERROR																			
6-5	RESERVED																			
7	BSS monitoring failure in Mode 1(Quiet mode)																			
Others	RESERVED																			
RESERVED	4	0x00000000																		

5.21.10 Sub block 0x5009 – AWR_AE_MSS_VMON_ERRORSTATUS_SB

This sub block indicates fault in analog supplies or LDO short circuit condition. Once a fault is detected the functionality cannot be resumed from then on and the sensor needs to be re-started (This API AE is not supported).

Table 5.157: AWR_AE_MSS_VMON_ERRORSTATUS_SB contents

Field Name	Number of bytes	Description								
SBLKID	2	Value = 0x5009								
SBLKLEN	2	Value = 16								
FAULT_TYPE	1	<table> <tr> <th>Value</th> <th>Definition</th> </tr> <tr> <td>0</td> <td>NO FAULT</td> </tr> <tr> <td>1</td> <td>ANALOG_SUPPLY_FAULT</td> </tr> <tr> <td>Others</td> <td>RESERVED</td> </tr> </table>	Value	Definition	0	NO FAULT	1	ANALOG_SUPPLY_FAULT	Others	RESERVED
Value	Definition									
0	NO FAULT									
1	ANALOG_SUPPLY_FAULT									
Others	RESERVED									
RESERVED	1	0x00								
RESERVED	2	0x0000								

Continued on next page

Table 5.157 – continued from previous page

FAULT_SIG	4	Bit	Definition
		b0	VDDIN under voltage indication
		b1	VDDIN over voltage indication
		b2	VIN_18CLK supply fault
		b3	VIOIN supply fault (Unable to resolve between 1.8V and 3.3V)
		b4	VIN_SRAM under voltage indication
		b5	VIOIN_18 supply fault
		b6	APLL_VCO_LDO short circuit
		b31:7	RESERVED
RESERVED	4	0x00000000	

5.21.11 Sub block 0x500A – AWR_AE_MSS_ADC_DATA_SB

This async event is in response to the command which indicates ADC data needs to be transferred over SPI. This async event contains the ADC data followed by more such async events for additional data.

Table 5.158: AWR_AE_MSS_ADC_DATA_SB contents

Field Name	Number of bytes	Description
SBLKID	2	Value = 0x500A
SBLKLEN	2	Value = Variable (max = 226)
REMCHUNKS	2	Number of remaining chunks expected. (Remaining length / 220 bytes)
ADC_DATA	Variable (4 - 220 bytes)	ADC data captured by the MMIC

5.21.12 Sub block 0x500B – RESERVED

6 API Programming Sequence

6.1 Single device mode

This section briefly describes in which order to issue the various API SBs defined in this document for a single device.

1. Power up the device
2. Wait for AWR_AE_MSSPOWERUPDONE_SB
3. AWR_DEV_CONFIGURATION_SET_SB
4. AWR_DEV_RFPOWERUP_SB
5. Wait for AWR_AE_RFPOWERUPDONE_SB
6. AWR_RF_STATIC_CONF_SET_MSG
 - a. AWR_RF_DEVICE_CFG_SB
 - b. AWR_CHAN_CONF_SET_SB
 - c. AWR_ADCOUT_CONF_SET_SB
 - d. AWR_RF_LDO_BYPASS_SB with RFLDOBYPASS_EN set to 1 if RF supply is 1.0 V
 - e. AWR_LOWPOWERMODE_CONF_SET_SB
 - f. AWR_DYNAMICPOWERSAVE_CONF_SET_SB
 - g. AWR_CAL_MON_FREQUENCY_TX_POWER_LIMITS_SB
 - h. AWR_RF_RADAR_MISC_CTL_SB if per chirp phase shifter and Advance chirp configuration needs to be enabled.
 - i. AWR_APLL_SYNTH_BW_CONTROL_SB
7. Data path configurations
 - a. AWR_DEV_RX_DATA_FORMAT_CONF_SET_SB
 - b. AWR_DEV_RX_DATA_PATH_CONF_SET_SB
 - c. AWR_DEV_RX_DATA_PATH_LANE_EN_SB
 - d. AWR_DEV_RX_DATA_PATH_CLK_SET_SB
 - e. AWR_HIGHSPEEDINTFCLK_CONF_SET_SB
 - f. AWR_DEV_LVDS_CFG_SET_SB / AWR_DEV_CSI2_CFG_SET_SB

8. AWR_RF_INIT_MSG
 - a. AWR_PHASE_SHIFTER_CAL_DATA_RESTORE_SB (To restore factory calibration data for TX0), keep CAL_APPLY = 0
 - b. AWR_PHASE_SHIFTER_CAL_DATA_RESTORE_SB (To restore factory calibration data for TX1), keep CAL_APPLY = 0
 - c. AWR_PHASE_SHIFTER_CAL_DATA_RESTORE_SB (To restore factory calibration data for TX2), keep CAL_APPLY = 1
 - d. AWR_CAL_DATA_RESTORE_SB (To restore factory calibration data to avoid on field RF interference during calibration)
 - e. Wait for AWR_AE_RF_INITCALIBSTATUS_SB
 - f. AWR_RF_INIT_CALIBRATION_CONF_SB (Enable only required calibration to run)
 - g. AWR_RFINIT_SB: This triggers very basic calibrations and RF initializations
 - h. Wait for AWR_AE_RF_INITCALIBSTATUS_SB
9. AWR_RF_DYNAMIC_CONF_SET_MSG
 - a. AWR_PROG_FILT_COEFF_RAM_SET_SB (Applicable only in xWR1642/xWR6843/xWR1843)
 - b. AWR_PROG_FILT_CONF_SET_SB (Applicable only in xWR1642/xWR6843/xWR1843)
 - c. AWR_PROFILE_CONF_SET_SB
 - d. Chirp configuration API
 - a. AWR_CHIRP_CONF_SET_SB
 - e. AWR_LOOPBACK_BURST_CONF_SET_SB (if using loopback burst in advance frame config API)
 - f. AWR_FRAME_CONF_SET_SB or AWR_ADVANCED_FRAME_CONF_SB with SW or HW triggered mode.
 - g. AWR_CALIB_MON_TIME_UNIT_CONF_SB with CALIB_MON_TIME_UNIT value set to a value such that the total frame idle time across multiple CALIB_MON_TIME_UNITS is sufficient for all calibrations and monitoring. See Section 12 for details on calibration and monitoring durations. If any error AWR_CAL_MON_TIMING_FAIL_REPORT_AE_SB AE will be generated when frame is triggered. The calibrations and monitors will not run properly if this error is generated.
 - h. AWR_RUN_TIME_CALIBRATION_CONF_AND_TRIGGER_SB (set all ONE_TIME_CALIB_ENABLE_MASK and set ENABLE_CAL_REPORT = 1)
 - i. Wait for AWR_RUN_TIME_CALIBRATION_SUMMARY_REPORT_AE_SB
 - j. AWR_RUN_TIME_CALIBRATION_CONF_AND_TRIGGER_SB (set all RUN_TIME_CALIB_ENABLE_MASK and set ENABLE_CAL_REPORT = 0 to avoid receiving periodic async events)
 - k. AWR_DEV_FRAME_CONFIG_APPLY_SB or AWR_DEV_ADV_FRAME_CONFIG_APPLY_SB

10. MONITOR CONFIGURATIONS

- a. AWR_MONITOR_RF_DIG_LATENTFAULT_CONF_SB : Wait for AWR_MONITOR_RF_DIG_LATENTFAULT_REPORT_AE_SB AE. This API should not be issue when frames are running.
- b. AWR_MSS_LATENTFAULT_TEST_CONF_SB : Wait for AWR_AE_MSS_LATENTFAULT_TESTREPORT_SB AE.
- c. AWR_MSS_PERIODICTESTS_CONF_SB : Enable periodic digital monitors, the monitor starts immediately after enabling this API.
- d. AWR_MONITOR_RF_DIG_PERIODIC_CONF_SB : Enable periodic digital monitors
- e. AWR_MONITOR_ANALOG_ENABLES_CONF_SB : Enable periodic analog monitors, The corresponding monitoring configuration APIs should be issued after issuing this API. Refer latest release note for all supported monitors.

11. AWR_RF_FRAME_TRIG_MSG

- a. AWR_FRAMESTARTSTOP_CONF_SB in Start mode (1): after this, frames get transmitted, wait for AWR_AE_RF_FRAME_TRIGGER_RDY_SB AE.

12. AWR_RF_FRAME_TRIG_MSG

- a. AWR_FRAMESTARTSTOP_CONF_SB in Stop mode (0): after this, frames are stopped. Wait for AWR_FRAME_END_AE_SB AE. The AWR_RF_FRAME_TRIG_MSG may be issued multiple times for multiple sets of frames. Refer AWR_FRAMESTARTSTOP_CONF_SB for more frame stop options.

6.2 Cascaded device mode

This section briefly describes in which order to issue the various API SBs defined in this document for master and slave devices in a cascaded configuration.

When using cascaded devices, the reference clock is provided by master to slave. So unless master is powered-up and clock is available from master to slave, the slave device cannot be powered up.

Table 6.1: Sequence of APIs to be issued to master and slave devices in cascaded mode configuration for FMCW mode measurements

Sl. No	Master device sequence	Slave device sequence
1	Power up master device	
2	Wait for AWR_AE_DEV_MSSPOWERUP-DONE_SB	
3	AWR_DEV_RFPOWERUP_SB	
4	Wait for AWR_AE_DEV_RFPOWERUP-DONE_SB	

Continued on next page

Table 6.1 – continued from previous page

5	AWR_CHAN_CONF_SET_SB with CAS-CADING_CFG = 0x0001. This will enable the reference clock for slave device	
6		Power on slave device
7		Wait for AWR_AE_DEV_MSSPOWERUP-DONE_SB
8		AWR_DEV_RFPOWERUP_SB
9		Wait for AWR_AE_DEV_RFPOWERUP-DONE_SB
10		AWR_CHAN_CONF_SET_SB with CAS-CADING_CFG = 0x0002.
11	AWR_ADCOUT_CONF_SET_SB	AWR_ADCOUT_CONF_SET_SB
12	AWR_RF_LDO_BYPASS_SB with RFLDOBYPASS_EN = 1 if RF supply is 1.0V	AWR_RF_LDO_BYPASS_SB with RFLDOBYPASS_EN = 1 if RF supply is 1.0V
13	AWR_LOWPOWERMODE_CONF_SET_SB	AWR_LOWPOWERMODE_CONF_SET_SB
14	AWR_DYNAMICPOWERSAVE_CONF_SET_SB	AWR_DYNAMICPOWERSAVE_CONF_SET_SB
15	AWR_RF_INIT_SB	AWR_RF_INIT_SB
16	Wait for AWR_AE_RF_INITIALIBSTATUS_SB	Wait for AWR_AE_RF_INITIALIBSTATUS_SB
17	AWR_DEV_RX_DATA_FORMAT_CONF_SET_SB	AWR_DEV_RX_DATA_FORMAT_CONF_SET_SB
18	AWR_DEV_RX_DATA_PATH_CONF_SET_SB	AWR_DEV_RX_DATA_PATH_CONF_SET_SB
19	AWR_DEV_RX_DATA_PATH_LANEEN_SET_SB	AWR_DEV_RX_DATA_PATH_LANEEN_SET_SB
20	AWR_HIGHSPEEDINTFCLK_CONF_SET_SB	AWR_HIGHSPEEDINTFCLK_CONF_SET_SB
21	AWR_DEV_RX_DATA_PATH_CLK_SET_SB	AWR_DEV_RX_DATA_PATH_CLK_SET_SB
22	AWR_DEV_LVDS_CFG_SET_SB/AWR_DEV_CSI2_CFG_SET_SB	AWR_DEV_LVDS_CFG_SET_SB/AWR_DEV_CSI2_CFG_SET_SB
23	AWR_PROFILE_CONF_SET_SB	AWR_PROFILE_CONF_SET_SB
24	AWR_CHIRP_CONF_SET_SB	AWR_CHIRP_CONF_SET_SB
25	AWR_FRAME_CONF_SET_SB with TRIGGER_SELECT = 0x0001	AWR_FRAME_CONF_SET_SB with TRIGGER_SELECT = 0x0002
26	AWR_DEV_FRAME_CONFIG_APPLY_MSG	AWR_DEV_FRAME_CONFIG_APPLY_MSG

Continued on next page

Table 6.1 – continued from previous page

27		AWR_FRAMESTARTSOP_CONF_SB with STARTSTOP_CMD = 0x0001
28		Wait for AWR_AE_RF_FRAME_TRIG- GER_RDY_SB
29	AWR_FRAMESTARTSOP_CONF_SB with STARTSTOP_CMD = 0x0001	
30	Wait for AWR_AE_RF_FRAME_TRIG- GER_RDY_SB	

6.3 Continuous streaming mode (in single device case)

This section briefly describes in which order to issue the various API SBs defined in this document to enable continuous streaming mode on a single device

1. Power up the device
2. Wait for AWR_AE_MSSPOWERUPDONE_SB
3. AWR_DEV_RFPOWERUP_SB
4. Wait for AWR_AE_RFPOWERUPDONE_SB
5. AWR_RF_MISC_CONF_SET_MSG
6. AWR_RF_STATIC_CONF_SET_MSG
 - a. AWR_CHAN_CONF_SET_SB
 - b. AWR_ADCOUT_CONF_SET_SB
 - c. AWR_RF_LDO_BYPASS_SB with RFLDOBYPASS_EN set to 1 if RF supply is 1.0V
 - d. AWR_LOWPOWERMODE_CONF_SET_SB
 - e. AWR_DYNAMICPOWERSAVE_CONF_SET_SB
7. AWR_RF_STATIC_CONF_SET_MSG
8. Data path configurations
 - a. AWR_DEV_RX_DATA_FORMAT_CONF_SET_SB
 - b. AWR_DEV_RX_DATA_PATH_CONF_SET_SB
 - c. AWR_DEV_RX_DATA_PATH_LANE_EN_SB
 - d. AWR_DEV_RX_DATA_PATH_CLK_SET_SB
 - e. AWR_HIGHSPEEDINTFCLK_CONF_SET_SB
 - f. AWR_DEV_LVDS_CFG_SET_SB / AWR_DEV_CSI2_CFG_SET_SB

9. AWR_RF_INIT_MSG
 - a. AWR_RFINIT_SB: This triggers very basic calibrations and RF initializations
 - b. Wait for AWR_AE_RF_INITCALIBSTATUS_SB
10. AWR_CONT_STREAMING_MODE_CONF_SET_SB
11. AWR_DEV_RX_CONTSTREAMING_MODE_CONF_SET_SB
12. AWR_CONT_STREAMING_MODE_EN_SB with CONT_STREAMING_EN = 0x0001 to start continuous streaming
13. AWR_CONT_STREAMING_MODE_EN_SB with CONT_STREAMING_EN = 0x0000 to stop continuous streaming
14. Repeat steps 9-11 for a different configuration

6.4 Continuous streaming (CW) mode (in cascaded device case)

Table 6.2: Sequence of APIs to be issued to master and slave devices in cascaded mode for CW mode measurements

Sl. No	Master device sequence	Slave device sequence
1	Power up master device	
2	Wait for AWR_AE_DEV_MSSPOWERUP-DONE_SB	
3	AWR_DEV_RFPOWERUP_SB	
4	Wait for AWR_AE_DEV_RFPOWERUP-DONE_SB	
5	AWR_CHAN_CONF_SET_SB with CAS-CADING_CFG = 0x0001. This will enable the reference clock for slave device	
6		Power on slave device
7		Wait for AWR_AE_DEV_MSSPOWERUP-DONE_SB
8		AWR_DEV_RFPOWERUP_SB
9		Wait for AWR_AE_DEV_RFPOWERUP-DONE_SB
10		AWR_RF_LDO_BYPASS_SB with RFLDOBYPASS_EN = 1 if RF supply is 1.0V
11		AWR_CHAN_CONF_SET_SB with CAS-CADING_CFG = 0x0002.

Continued on next page

Table 6.2 – continued from previous page

12	AWR_ADCOUT_CONF_SET_SB	AWR_ADCOUT_CONF_SET_SB
13	AWR_RF_LDO_BYPASS_SB with RFLDOBYPASS_EN = 1 if RF supply is 1.0V	
14	AWR_LOWPOWERMODE_CONF_SET_SB	AWR_LOWPOWERMODE_CONF_SET_SB
15	AWR_DYNAMICPOWERSAVE_CONF_SET_SB	AWR_DYNAMICPOWERSAVE_CONF_SET_SB
16	AWR_RF_INIT_SB	AWR_RF_INIT_SB
17	Wait for AWR_AE_RF_INITIALIBSTATUS_SB	Wait for AWR_AE_RF_INITIALIBSTATUS_SB
18	AWR_DEV_RX_DATA_FORMAT_CONF_SET_SB	AWR_DEV_RX_DATA_FORMAT_CONF_SET_SB
19	AWR_DEV_RX_DATA_PATH_CONF_SET_SB	AWR_DEV_RX_DATA_PATH_CONF_SET_SB
20	AWR_DEV_RX_DATA_PATH_LANEEN_SET_SB	AWR_DEV_RX_DATA_PATH_LANEEN_SET_SB
21	AWR_HIGHSPEEDINTFCLK_CONF_SET_SB	AWR_HIGHSPEEDINTFCLK_CONF_SET_SB
22	AWR_DEV_RX_DATA_PATH_CLK_SET_SB	AWR_DEV_RX_DATA_PATH_CLK_SET_SB
23	AWR_DEV_LVDS_CFG_SET_SB/AWR_DEV_CSI2_CFG_SET_SB	AWR_DEV_LVDS_CFG_SET_SB/AWR_DEV_CSI2_CFG_SET_SB
24	AWR_CONT_STREAMING_MODE_CONF_SET_SB	
25	AWR_CONT_STREAMING_MODE_EN_SB with CONT_STREAMING_EN = 0x0001 to start continuous streaming	
26		AWR_CONT_STREAMING_MODE_CONF_SET_SB with the same RF frequency configuration as in master device
27		AWR_CONT_STREAMING_MODE_EN_SB with CONT_STREAMING_EN = 0x0001 to start continuous streaming
28		AWR_CONT_STREAMING_MODE_EN_SB with CONT_STREAMING_EN = 0x0000 to stop continuous streaming
29	AWR_CONT_STREAMING_MODE_EN_SB with CONT_STREAMING_EN = 0x0000 to stop continuous streaming	

Continued on next page

Table 6.2 – continued from previous page

30	Repeat steps 24-29 for a different CW mode configuration	
----	----------------------------------------------------------	--

7 API Error Codes

Table 7.1: BSS API error codes

Applicable to all API sub blocks	1	Incorrect API MSGID
	2	Sub block not found in the MSG
	3	Incorrect Sub block ID
	4	Incorrect Sub block length
	5	Incorrect Sub block data
	6	Error in processing the command
	7	Binary file CRC mismatch error
	8	Binary file type mismatch w.r.t. magic number
AWR_FRAMESTARTSTOP_CONF_SB	20	Frames are already started when the FRAME_START command was issued
	21	Frames are already stopped when the FRAME_STOP command was issued
	22	No valid frame configuration API was issued and frames are started
	23	START_STOP_CMD parameter is out of range
AWR_CHAN_CONF_SET_SB	24	RX_CHAN_EN parameter is out of range (Max range may vary based on device variant)
	25	TX_CHAN_EN parameter is out of range (Max range may vary based on device variant)
	26	CASCADING_CFG parameter is out of range [0, 2]
	282	Device variant does not allow cascading but API is issued to enable cascading mode
AWR_ADCOUT_CONF_SET_SB	27	NUM_ADC_BITS parameter is out of range [0, 2]
	28	ADC_OUT_FMT parameter is out of range [0, 3]
	127	FULL_SCALE_REDUCTION_FACTOR is > 0 for 16 bit ADC, or > 2 for 14 bit ADC mode or > 4 for 12 bit ADC mode
AWR_LOWPOWERMODE_CONF_SET_SB	29	LP_ADC_MODE parameter is out of range [0, 1]
	156	Regular ADC mode is used on a 5 MHz part variant device
AWR_DYNAMICPOWERSAVE_CONF_SET_SB	30	BLOCK_CFG parameter is out of range [0, 7]

Continued on next page

Table 7.1 – continued from previous page

AWR_ HIGHSPEEDINTFCLK_ CONF_SET_SB	31	HSICLKRATECODE[1:0] is 0
	32	RESERVED
	33	HSICLKRATECODE[3:2] is 3 and HSICLKRATECODE[1:0] is 2
	34	HSICLKRATECODE[3:2] is 3 and HSICLKRATECODE[1:0] is 2
AWR_PROFILE_CONF_ SET_SB	35	PF_INDX is ≥ 4
	36	PF_FREQ_START_CONST is not within [76, 81] GHz
	37	PF_IDLE_TIME_CONST > 5.24 ms
	38	Maximum DFE spill time (refer rampgen calculator in mmWave Studio for more details) > PF_IDLE_TIME_CONST
	39	PF_ADC_START_TIME_CONST > 4095
	40	PF_RAMP_END_TIME > 524287
	41	PF_RAMP_END_TIME < PF_ADC_START_TIME_CONST + ADC_SAMPLING_TIME (ADC_SAMPLING_TIME is time taken to sample NUM_ADC_SAMPLES)
	42	PF_TX_OUTPUT_POWER_BACKOFF for TX0 > 30
	43	PF_TX_OUTPUT_POWER_BACKOFF for TX1 > 30
	44	PF_TX_OUTPUT_POWER_BACKOFF for TX2 > 30
	45	RESERVED
	46	Ramp end frequency is not within [76, 81] GHz
	47	Absolute value of TX_START_TIME is > 38.45 μ s
	48	Number of ADC samples is not within [2, 8192]
	49	Output sampling rate is not within [2, MaxSamplingRate] Msps. See Table 5.24 for the MaxSamplingRate.
	50	HPF1 corner frequency is > 700 kHz
	51	HPF2 corner frequency is > 2.8 MHz
	52	PF_RX_GAIN is not within [24, 52] dB or PF_RX_GAIN is an odd number
	53	RESERVED
	54	RESERVED
55	RESERVED	
56	RESERVED	
57	RESERVED	
58	RESERVED	
AWR_CHIRP_CONF_ SET_SB	59	CHIRP_START_INDX ≥ 512

Continued on next page

Table 7.1 – continued from previous page

	60	CHIRP_END_INDX \geq 512
	61	CHIRP_START_INDX > CHIRP_END_INDX
	62	PROFILE_INDX \geq 4
	63	If the profile corresponding to PROFILE_INDX is not defined
	64	CHIRP_FREQ_START_VAR > 8388607
	65	CHIRP_FREQ_SLOPE_VAR > 63
	66	Chirp start frequency is outside [76, 78] GHz if the selected VCO is VCO1 or Chirp start frequency is outside [77, 81] GHz if the selected VCO is VCO2 or Chirp end frequency is outside [76, 78] GHz if the selected VCO is VCO1 or Chirp end frequency is outside [77, 81] GHz if the selected VCO is VCO2 or Chirp bandwidth is greater than maximum allowed as per device data sheet or Maximum chirp frequency is greater than maximum allowed as per device data sheet
	67	CHIRP_IDLE_TIME_VAR > 4095
	68	CHIRP_ADC_START_TIME_VAR > 4095
	69	RAMP_END_TIME < ADC_START_TIME + ADC_SAMPLING_TIME
	70	CHIRP_TX_EN > maximum simultaneous TX allowed as per device data sheet
71	CHIRP_TX_EN indicates to enable a TX which is not enabled in AWR_CHAN_CONF_SET_SB	
AWR_FRAME_CONF_SET_SB	72	CHIRP_START_INDX \geq 512
	73	CHIRP_END_INDX \geq 512
	74	CHIRP_START_INDX > CHIRP_END_INDX
	75	Chirp used in the frame is not configured by AWR_CHIRP_CONF_SET_SB
	76	One of the profiles used in the frame is not configured by AWR_PROF_CONF_SET_SB
	77	NUM_LOOPS is outside [1, 255]
	78	RESERVED
	79	FRAME_PERIODICITY is outside [100 μ s, 1.342 s]
	80	FRAME_ON_TIME > FRAME_PERIODICITY
	81	TRIGGER_SELECT is outside [1, 2]
	82	FRAME_TRIGGER_DELAY > 100 μ s
	83	API is issued when frames are ongoing

Continued on next page

Table 7.1 – continued from previous page

	160	The Dummy chirps at end of frame is not supported
AWR_ADVANCED_ FRAME_CONF_SET_ SB	84	NUM_SUBFRAMES is outside [1, 4]
	85	FORCE_SINGLE_PROFILE is outside [0, 1]
	86	FORCE_SINGLE_PROFILE \geq 4
	87	Profile defined by FORCE_SINGLE_PROFILE is not defined
	88	SF _x _CHIRP_START_IND _X \geq 512
	89	SF _x _NUM_UNIQUE_CHIRPS_PER_BURST is outside the range [1, 512]
	90	Chirp used in the frame is not configured by AWR_CHIRP_CONF_SET_SB
	91	One of the profiles used in the frame is not configured by AWR_PROF_CONF_SET_SB
	92	SF _x _NUM_LOOPS_PER_BURST is outside the range [1, 255]
	93	SF _x _BURST_PERIOD is outside the range [100 μ s, 1.342 s]
	94	Burst ON time is $>$ BURST_PERIOD
	95	SF _x _CHIRP_START_IND _X _OFFSET \geq 512
	96	SF _x _CHIRP_START_IND _X \geq 512 or SF _x _CHIRP_START_IND _X + SF _x _NUM_UNIQUE_CHIRPS_PER_BURST – 1 is \geq 512
	97	SF _x _NUM_BURSTS is outside the range [1, 512]
	98	SF _x _NUM_OUTER_LOOPS is outside the range [1, 64]
	99	SF _x _PERIOD is outside the range [100 μ s, 1.342 s]
	100	Subframe on time $>$ SF _x _PERIOD or when TESTSOURCE is enabled, SubFrame Idle time is $<$ 150 μ s
101	RESERVED	
102	TRIGGER_SELECT is outside the range [1, 2]	
103	FRAME_TRIGGER_DELAY is $>$ 100 μ s	
104	API is issued when frames are on going	
AWR_RF_TEST_ SOURCE_CONFIG_ SET_SB	105	POSITION_VEC _x [y] $<$ 0
	106	RESERVED
	107	VELOCITY_VEC _x [x] $>$ 5000 or VELOCITY_VEC _x [y] $>$ 5000 or VELOCITY_VEC _x [z] $>$ 5000

Continued on next page

Table 7.1 – continued from previous page

	108	SIG_LEV_VECx > 950
	109	RX_ANT_POS_XZ[Byte] > 120
	110	RESERVED
AWR_PROG_FILT_CONF_SET_SB	111	PROG_FILT_COEFF_START_INDEX is an odd number
	112	PROFILE_INDX ≥ 4
	126	DFE mode is pseudo real
AWR_PROG_FILT_COEFF_RAM_SET_SB	113	API is issued for a non xWR1642/xWR1843 device
	126	DFE mode is pseudo real
AWR_RF_RADAR_MISC_CTL_SB	114	API is issued for an unsupported device
AWR_PERCHIRPPHASESHIFT_CONF_SB	115	CHIRP_START_INDX ≥ 512
	116	CHIRP_END_INDX ≥ 512
	117	CHIRP_START_INDX > CHIRP_END_INDX
AWR_RUN_TIME_CALIBRATION_CONF_AND_TRIGGER_SB	118	Boot time calibrations are not done so cannot run runtime calibrations
AWR_CAL_MON_FREQUENCY_LIMITS_SB	119	FREQ_LIMIT_HIGH < 76 GHz or FREQ_LIMIT_HIGH > 81 GHz or FREQ_LIMIT_LOW > FREQ_LIMIT_HIGH
	130	The minimum RF frequency band is < 200MHz
AWR_CALIB_MON_TIME_UNIT_CONF_SB	120	CALIB_MON_TIME_UNIT ≤ 0
	128	NUM_OF_CASCADEDEV ≤ 0
AWR_RUN_TIME_CALIBRATION_CONF_AND_TRIGGER_SB	121	CALIBRATION_PERIODICITY = 0
	122	API is issued when continuous streaming mode is on
	123	RX gain run time calibration was requested but boot time calibration was not performed
	124	LO distribution run time calibration was requested but boot time calibration was not performed
	125	TX power run time calibration was requested but boot time calibration was not performed
AWR_LOOPBACK_BURST_CONF_SET_SB	132	LOOPBACK_SEL is > 3
	133	BURST_INDX ≥ 16
	134	Burst is not valid but loopback is enabled for this burst

Continued on next page

Table 7.1 – continued from previous page

AWR_DYN_CHIRP_CONF_SET_SB	135	CHIRP_SEGMENT_SELECT > 31 if CHIRP_ROW_SELECT = 0 or CHIRP_SEGMENT_SELECT > 11 if CHIRP_ROW_SELECT != 0
	159	CHIRP_ROW_SELECT > 3
AWR_DYN_PER_CHIRP_PHASESHIFTER_CONF_SB	136	CHIRP_SEGMENT_SELECT > 31
AWR_CAL_DATA_RESTORE_SB	137	CHUNK_ID ≥ NUM_CHUNKS
	138	CAL_DATA is invalid
	318	TX_IND is invalid in phase shifter restore API
AWR_INTERCHIRP_BLOCKCONTROLS_SB	139	RX02_RF_TURN_OFF_TIME is not within the range [-1024, 1023]
	140	RX13_RF_TURN_OFF_TIME is not within the range [-1024, 1023]
	141	RX02_BB_TURN_OFF_TIME is not within the range [-1024, 1023]
	142	RX13_BB_TURN_OFF_TIME is not within the range [-1024, 1023]
	143	RX02_RF_PREENABLE_TIME is not within the range [-1024, 1023]
	144	RX13_RF_PREENABLE_TIME is not within the range [-1024, 1023]
	145	RX02_BB_PREENABLE_TIME is not within the range [-1024, 1023]
	146	RX13_BB_PREENABLE_TIME is not within the range [-1024, 1023]
	147	RX02_RF_TURN_ON_TIME is not within the range [-1024, 1023]
	148	RX13_RF_TURN_ON_TIME is not within the range [-1024, 1023]
	149	RX02_BB_TURN_ON_TIME is not within the range [-1024, 1023]
	150	RX13_BB_TURN_ON_TIME is not within the range [-1024, 1023]
	151	RX_LO_TURN_OFF_TIME is not within the range [-1024, 1023]
	152	TX_LO_TURN_OFF_TIME is not within the range [-1024, 1023]

Continued on next page

Table 7.1 – continued from previous page

	153	RX_LO_TURN_ON_TIME is not within the range [-1024, 1023]
	154	TX_LO_TURN_ON_TIME is not within the range [-1024, 1023]
AWR_SUBFRAME_START_CONF_SB	155	Sub-frame start command is issued but the frame is not configured for sub frame trigger mode
Common to all monitoring configuration APIs	250	Device type is not ASILB
	251	Fault injection API or Digital latent fault API is issued when frames are ongoing
	252	Invalid reporting mode
	253	Configured profile ID is not within [0, 3]
	254	Monitoring profile ID is not configured yet
	260	Invalid RF bit mask
	281	Analog monitoring is not supported
	290	Monitoring chirp error
AWR_MONITOR_RF_DIG_LATENTFAULT_CONF_SB	251	API is issued when frames are on-going
AWR_MONITORING_EXTERNAL_ANALOG_SIGNALS_CONF_SB	255	Settling time is configured is more than 12 μ s
AWR_MONITOR_RX_INTERNAL_ANALOG_SIGNALS_CONF_SB	256	None of the RXs are enabled
AWR_MONITOR_TX0_INTERNAL_ANALOG_SIGNALS_CONF_SB	257	TX0 is not enabled
AWR_MONITOR_TX1_INTERNAL_ANALOG_SIGNALS_CONF_SB	258	TX1 is not enabled
AWR_MONITOR_TX2_INTERNAL_ANALOG_SIGNALS_CONF_SB	259	TX2 is not enabled
-	261	RESERVED
-	262	RESERVED
AWR_MONITOR_TXn_BALLBREAK_CONF_SB	263	Monitored TX channel is not enabled
AWR_MONITOR_RX_GAIN_PHASE_CONF_SB	264	Monitored RX channel is not enabled

Continued on next page

Table 7.1 – continued from previous page

AWR_MONITOR_RX_NOISE_FIGURE_CONF_SB		
AWR_MONITOR_RX_GAIN_PHASE_CONF_SB	265	TX selected for RX gain phase monitor is TX2 (Only TX0 or TX1 is allowed)
	291	PD power level is less than -40dBm (Used for RX Gain Monitor)
	295	PGA Gain used for monitoring is incorrect
AWR_MONITOR_RX_SATURATION_DETECTOR_CONF_SB	266	SAT_MON_SEL is not in [0, 3]
	267	SAT_MON_PRIMARY_TIME_SLICE_DURATION is less than 0.64 μ s or greater than ADC sampling time
	268	SAT_MON_NUM_SLICES is 0 or greater than 127
	283	RX saturation monitor is not supported
AWR_MONITOR_SIG_IMG_MONITOR_CONF_SB	269	SIG_IMG_MON_NUM_SLICES is 0 or greater than 127
	270	NUM_SAMPLES_PER_PRIMARY_TIME_SLICE is odd, or less than 4 in Complex1x mode or less than 8 in non-Complex1x modes or greater than NUM_ADC_SAMPLES
	280	Signal and image band monitor is not supported
AWR_ANALOG_FAULT_INJECTION_CONF_SB	279	LDO fault inject is requested but LDOs are bypassed
AWR_MONITOR_TXn_POWER_CONF_SB	294	PD Reading incorrect (RF OFF reading higher than RF ON reading)
AWR_MONITOR_TXn_BALLBREAK_CONF_SB	319	Invalid monitoring start frequency [Only applicable to xWR6x43 devices].
AWR_MONITOR_RX_INTERNAL_ANALOG_SIGNALS_CONF_SB		
AWR_MONITOR_RX_GAIN_PHASE_CONF_SB AWR_MONITOR_TX_GAIN_PHASE_CONF_SB AWR_MONITOR_TXn_BPM_CONF_SB	292	ADC power level higher than +7 dBm or lower than -9.5 dBm
AWR_MONITOR_RX_NOISE_FIGURE_CONF_SB	293	Low RX noise figure (Noise Figure is less than 0 dB)
AWR_MONITOR_PM-CLKLO_INTERNAL_ANALOG_SIGNALS_CONF_SB	296	The 20G monitor is not supported in single chip configuration
AWR_MONITOR_SYNTHESIZER_FREQUENCY_CONF_SB	274	MONITOR_START_TIME is outside the specified range.

Continued on next page

Table 7.1 – continued from previous page

	297	MONITOR_CONFIG_MODE is invalid.
	298	The both Live and Non-live synth frequency monitors are cannot be enabled together.

Table 7.2: MSS API error codes (Applicable only in AWR1243/AWR2243)

Applicable to all API sub blocks	1	Incorrect API MSGID
	2	Sub block not found in the MSG
	3	Incorrect Sub block ID
	4	Incorrect Sub block length
	5	Incorrect Sub block data
	6	Error in processing the command
	7	Binary file CRC mismatch error
	8	Binary file type mismatch w.r.t. magic number
AWR_DEV_RX_DATA_FORMAT_CONF_SET_SB	1001	RX_CHAN_EN > 0xF
	1002	NUM_ADC_BITS > 2
	1003	ADC_OUT_FMT > 1
	1004	IQ_SWAP_SEL > 1
	1005	CHAN_INTERLEAVE > 1
AWR_DEV_RX_DATA_PATH_CONF_SET_SB	1006	DATA_INTF_SEL > 1
	1007	DATA_TRANS_FMT_PKT0 [5:0] not a valid value. Valid set {0x1, 0x6, 0x9, 0x36}
	1008	DATA_TRANS_FMT_PKT1 [5:0] not a valid value. Valid set {0x0, 0xD, 0xB}
	1050	CQ_CONFIG is out of range
AWR_DEV_RX_DATA_PATH_LANEEN_SET_SB	1009	LANE_EN > 0xF
	1010	Reserved
AWR_DEV_RX_DATA_PATH_CLK_SET_SB	1011	LANE_CLK_CFG > 1
	1012	LANE_CLK_CFG != 1 for CSI2
	1013	DATA_RATE - Invalid combination of data rate and DDR or SDR operation
AWR_DEV_LVDS_CFG_SET_SB	1014	LANE_FMT_MAP > 1
	1015	LANE_PARAM_CFG > 7

Continued on next page

Table 7.2 – continued from previous page

AWR_DEV_RX_CON- TSTREAMING_MODE_ CONF_SET_SB	1016	CONT_STREAMING_MODE > 1
	1017	CONT_STREAMING_MODE already in requested mode
AWR_DEV_CSI2_CFG_ SET_SB	1018	LANE_POS_POL_SEL [DATA_LANE0_POS] >5
	1019	LANE_POS_POL_SEL [DATA_LANE1_POS] >5
	1020	LANE_POS_POL_SEL [DATA_LANE2_POS] >5
	1021	LANE_POS_POL_SEL [DATA_LANE3_POS] >5
	1022	LANE_POS_POL_SEL [CLOCK_POS] is outside the range [2,4]
AWR_DEV_FRAME_ CONFIG_APPLY_SB	1023	HALF_WORDS_PER_CHIRP is outside the range [64, 8192]
AWR_DEV_ADV_ FRAME_CONFIG_AP- PLY_SB	1024	NUM_SUBFRAMES is outside the range [1,4]
	1025	SF1_TOT_NUM_CHIRPS is outside the range [1, 0xFFFF]
	1026	SF1_NUM_ADC_SAMPLES_PER_DATA_PKT is outside the range [64, 8192]
	1027	SF1_PROC_NUM_CHIRPS_PER_DATA_PKT != 1
	1028	SF2_TOT_NUM_CHIRPS is outside the range [1, 0xFFFF], if NUM_SUBFRAMES ≥ 2
	1029	SF2_NUM_ADC_SAMPLES_PER_DATA_PKT is outside the range [64, 8192], if NUM_SUBFRAMES ≥ 2
	1030	SF2_PROC_NUM_CHIRPS_PER_DATA_PKT != 1, if NUM_SUBFRAMES ≥ 2
	1031	SF3_TOT_NUM_CHIRPS is outside the range [1, 0xFFFF], if NUM_SUBFRAMES ≥ 3
	1032	SF3_NUM_ADC_SAMPLES_PER_DATA_PKT is outside the range [64, 8192], if NUM_SUBFRAMES ≥ 3
	1033	SF3_PROC_NUM_CHIRPS_PER_DATA_PKT != 1, if NUM_SUBFRAMES ≥ 3
	1034	SF4_TOT_NUM_CHIRPS is outside the range [1, 0xFFFF], if NUM_SUBFRAMES == 4
	1035	SF4_NUM_ADC_SAMPLES_PER_DATA_PKT is outside the range [64, 8192], if NUM_SUBFRAMES == 4
	1036	SF4_PROC_NUM_CHIRPS_PER_DATA_PKT != 1, if NUM_SUBFRAMES == 4
AWR_DEV_MCUCLOCK_ CONF_SET_SB	1040	MCUCLOCK_CTRL is out of range

Continued on next page

Table 7.2 – continued from previous page

	1041	MCUCLOCK_SRC is out of range
AWR_DEV_PMICCLOCK_CONF_SET_SB	1042	PMICCLOCK_CTRL is out of range
	1043	PMICCLOCK_SRC is out of range
	1044	MODE_SELECT is out of range
	1045	FREQ_SLOPE is out of range
	1046	CLK_DITHER_EN is out of range
AWR_DEV_TESTPATTERN_GEN_SET_SB	1047	TESTPATTERN_GEN_CTRL is out of range
	1048	DATA_INTF_SEL (Data interface selected in AWR_DEV_RX_DATA_PATH_CONF_SET_SB) is SPI
AWR_MSS_LATENT_FAULT_TEST_CONF_SB	1051	RL_API_NRESP_LFAULTTEST_UNSUPPORTED_OOR (Unsupported Latent Fault test selected in AWR_MSS_LATENTFAULT_TEST_CONF_SB)

7.1 Error codes for boot on SPI

Table 7.3: Bit field describing the error status during boot on SPI

Error description	Error code	Error code bit position
CERT_AUTH_FAILURE	0x0000000000000001	BIT0
CERT_PARSER_FAILURE	0x0000000000000002	BIT1
RPRC_IMG1_AUTH_FAILURE	0x0000000000000004	BIT2
RPRC_IMG2_AUTH_FAILURE	0x0000000000000008	BIT3
RPRC_IMG3_AUTH_FAILURE	0x0000000000000010	BIT4
RPRC_HDR_NOT_FOUND	0x0000000000000020	BIT5
METAHEADER_NOT_FOUND	0x0000000000000040	BIT6
SW_ANTIROLLBACK_CHK_FAILURE	0x0000000000000080	BIT7
EFUSE_INTEGRITY_FAILURE	0x0000000000000100	BIT8
CERT_FIELD_VALIDITY_FAILURE	0x0000000000000200	BIT9
CERT_FIELD_INVALID_AUTH_KEY_INDEX	0x0000000000000400	BIT10
CERT_FIELD_INVALID_HASH_TYPE	0x0000000000000800	BIT11
CERT_FIELD_INVALID_SUBSYSTEM	0x0000000000001000	BIT12
CERT_FIELD_INVALID_DECRYPT_KEY_INDEX	0x0000000000002000	BIT13

Continued on next page

Table 7.3 – continued from previous page

CERT_FIELD_CEK_EFUSE_MISMATCH	0x000000000004000	BIT14
CERT_FIELD_CEK1_EFUSE_MISMATCH	0x000000000008000	BIT15
CERT_FIELD_CEK2_EFUSE_MISMATCH	0x000000000010000	BIT16
CERT_FIELD_INVALID_SUBSYSTEM_BANK_ALLOCATION	0x000000000020000	BIT17
CERT_FIELD_INVALID_TOTAL_BANKS_ALLOCATION	0x000000000040000	BIT18
RPRC_PARSER_FILE_LENGTH_MISMATCH	0x000000000080000	BIT19
RPRC_PARSER_MSS_FILE_OFFSET_MISMATCH	0x000000000100000	BIT20
RPRC_PARSER_BSS_FILE_OFFSET_MISMATCH	0x000000000200000	BIT21
RPRC_PARSER_DSS_FILE_OFFSET_MISMATCH	0x000000000400000	BIT22
CERT_FIELD_INVALID_DECRYPT_KEY	0x000000000800000	BIT23
CERT_FIELD_INVALID_AUTH_KEY	0x000000001000000	BIT24
HS_DEVICE_CERT_NOT_PRESENT	0x000000002000000	BIT25
ERROR_IN_2K_IMAGE	0x000000004000000	BIT26
SHARED_MEM_ALLOC_FAILED	0x000000008000000	BIT27
MSSIMAGE_NOT_FOUND	0x000000010000000	BIT28
METAHEADER_NUMFILES_ERROR	0x000000020000000	BIT29
METAHEADER_CRC_FAILURE	0x000000040000000	BIT30
RPRC_IMG4_AUTH_FAILURE	0x000000080000000	BIT31
RPRC_PARSER_CONFIG_FILE_OFFSET_MISMATCH	0x000000100000000	BIT32
BOOT_EXTS_EXTRACTION_FAILURE	0x000000200000000	BIT33
DEVICE_UID_BAD_SIZE	0x000000400000000	BIT34
KEY_DERIVE_FUNC_BAD_SIZE	0x000000800000000	BIT35
HMAC_BAD_SIZE	0x000001000000000	BIT36
AES_INIT_VECTOR_BAD_SIZE	0x000002000000000	BIT37
SECDEV_TI_KEY_ERASE_FAILED	0x000004000000000	BIT38
SOP5_SFLASH_NOT_FOUND	0x000008000000000	BIT39
XTAL_CLK_DETECTION_FAILED	0x001000000000000	BIT48
CONTINUE_BOOTUP_ON_XTAL	0x002000000000000	BIT49
DSP_POWERUP_TIMEOUT_ERR	0x004000000000000	BIT50
MSS_LBIST_FAILED	0x008000000000000	BIT51

Continued on next page

Table 7.3 – continued from previous page

DSP_LBIST_PBIST_FAILED	0x0100000000000000	BIT52
PBIST_SINGLE_PORT_MEM_FAILED	0x0200000000000000	BIT53
PBIST_TWO_PORT_MEM_FAILED	0x0400000000000000	BIT54
MEMORY_INIT_FAILED	0x0800000000000000	BIT55
MSSROM_PBIST_CRC_COMPUTATION_FAILED	0x1000000000000000	BIT56
VMON_ERROR_DETECTED	0x2000000000000000	BIT57
ESM_NERROR_DETECTED	0x8000000000000000	BIT63

8 Radar Monitoring APIs

sec:RadarMonApis

AWR monitoring can be configured through a set of API sub blocks defined in this section. Note that these APIs cover the RF/Analog related monitoring mechanisms. There are separate monitoring mechanisms for the digital logic (including the processor, memory, etc.) which are internal to the device and not explicitly enabled through these APIs.

The monitoring APIs are structured as follows. There are common configuration APIs that control the overall periodicity of monitoring, as well as, enable/disable control for each monitoring mechanism. Then, for each monitoring mechanism there is an individual API to allow the customer to set an appropriate threshold for declaring failure from that monitoring. Also, for each monitoring mechanism, there is an individual API to report soft (raw) values from that monitoring.

NOTE1: Each monitor can perform monitoring on only one profile at a time. Though it is possible that different monitors can monitor different profiles simultaneously.

NOTE2: None of the Safety Monitoring supported in QM devices except Rx saturation and signal image monitor defined in page 335, The monitoring configurations defined below from sub-block ID 0x01C0 to 0x01DF are not valid in QM devices.

NOTE3: All Monitoring configurations and enable control APIs shall be issues before triggering the frames. The run time programming or configuration update for monitors are not supported while frames are running.

8.1 Common Configurations and Reports

This section covers the APIs corresponding to the common configurations and reports.

8.1.1 Sub block 0x01C0 – AWR_MONITOR_RF_DIG_LATENTFAULT_CONF_SB

This API SB contains the consolidated configuration of all digital monitoring. This is issued by the host to the AWR device.

The enabled monitoring functions are executed when the API is issued, this API should be issued only when frames are not running, these are destructive tests. The scheduling of these monitoring should be handled in the external application. Report of these monitoring will be available in the async event [AWR_MONITOR_RF_DIG_LATENTFAULT_REPORT_AE_SB](#).

Table 8.1: AWR_MONITOR_RF_DIG_LATENTFAULT_CONF_SB contents

Field Name	Number of bytes	Description
SBLKID	2	Value = 0x01C0
SBLKLEN	2	Value = 16
DIG_MONITORING_ENABLES	4	1 – Enable, 0 – Disabled Bit Definition b0 RESERVED b1 CR4 and VIM lockstep test b2 RESERVED b3 VIM test (Not supported in 1st Gen devices, refer latest release note) b4 RESERVED b5 RESERVED b6 CRC test b7 RAMPGEN memory ECC (Not supported in 1st Gen devices, refer latest release note) b8 DFE Parity test b9 DFE memory ECC b10 RAMPGEN lockstep test b11 FRC lockstep test of diagnostic b12 RESERVED b13 RESERVED b14 RESERVED b15 RESERVED b16 ESM test b17 DFE STC b18 RESERVED b19 ATCM, BTCM ECC test b20 ATCM, BTCM parity test b21 RESERVED b22 RESERVED b23 RESERVED b24 FFT test b25 RTI test b26 RESERVED b31:27 RESERVED

Continued on next page

Table 8.1 – continued from previous page

TEST_MODE	1	Value	Definition
		0	Production mode. Latent faults are tested and any failures are reported
		1	Characterization mode. Faults are injected and failures are reported which allows testing of the failure reporting path
RESERVED	3	0x000000	
RESERVED	4	0x00000000	

NOTE: The Characterization TEST_MODE is supported only for debug, in production or run time this test mode is not supported. The device reset is required after entering this mode.

8.1.2 Sub block 0x01C1 – AWR_MONITOR_RF_DIG_PERIODIC_CONF_SB

This API SB contains the consolidated configuration of all periodic digital monitoring within radar sub-system. This is issued by the host to the AWR device.

The enabled monitoring functions are executed periodically and reports are sent based on reporting mode. Report of these monitoring will be available in the async event [AWR_MONITOR_RF_DIG_PERIODIC_REPORT_AE_SB](#).

Table 8.2: AWR_MONITOR_RF_DIG_PERIODIC_CONF_SB contents

Field Name	Number of bytes	Description	
SBLKID	2	Value = 0x01C1	
SBLKLEN	2	Value = 16	
REPORTING_MODE	1	Value	Definition
		0	Report is sent every monitoring period
		1	Report is sent only on a failure
		2	RESERVED
RESERVED	3	0x000000	
PERIODIC_DIG_MON_EN	4	1 – Enable, 0 – Disable	
		Bit	Monitoring type
		b0	PERIODIC_CONFIG_REGISTER_READ_EN
		b1	RESERVED
		b2	DFE_STC_EN
		b3	FRAME_TIMING_MONITORING_EN
		b31:4	RESERVED

Continued on next page

Table 8.2 – continued from previous page

RESERVED	4	0x00000000
----------	---	------------

8.1.3 Sub block 0x01C2 – AWR_MONITOR_ANALOG_ENABLES_CONF_SB

This API SB contains the consolidated configuration of all analog monitoring. This is issued by the host to the AWR device.

The enabled monitoring functions are executed with a periodicity of CAL_MON_TIME_UNITS number of logical frames. The host should ensure that all the enabled monitors can be completed in the available inter-frame times, based on the monitoring durations (to be provided separately).

Table 8.3: AWR_MONITOR_ANALOG_ENABLES_CONF_SB contents

Field Name	Number of bytes	Description
SBLKID	2	Value = 0x01C2
SBLKLEN	2	Value = 12

Continued on next page

Table 8.3 – continued from previous page

ANA_MONITOR- ING_ENABLES	4	<p>If any bit in this field is set to 1, the associate monitors are enabled. The configurations and reports of each monitors are described in respective sub sections.</p> <table border="0"> <thead> <tr> <th data-bbox="662 436 694 459">Bit</th> <th data-bbox="758 436 869 459">Definition</th> </tr> </thead> <tbody> <tr><td>b0</td><td>TEMPERATURE_MONITOR</td></tr> <tr><td>b1</td><td>RX_GAIN_PHASE_MONITOR</td></tr> <tr><td>b2</td><td>RX_NOISE_FIGURE_MONITOR</td></tr> <tr><td>b3</td><td>RX_IFSTAGE_MONITOR</td></tr> <tr><td>b4</td><td>TX0_POWER_MONITOR</td></tr> <tr><td>b5</td><td>TX1_POWER_MONITOR</td></tr> <tr><td>b6</td><td>TX2_POWER_MONITOR</td></tr> <tr><td>b7</td><td>TX0_BALLBREAK_MONITOR</td></tr> <tr><td>b8</td><td>TX1_BALLBREAK_MONITOR</td></tr> <tr><td>b9</td><td>TX2_BALLBREAK_MONITOR</td></tr> <tr><td>b10</td><td>TX_GAIN_PHASE_MISMATCH_MONITOR</td></tr> <tr><td>b11</td><td>TX0_BPM_MONITOR</td></tr> <tr><td>b12</td><td>TX1_BPM_MONITOR</td></tr> <tr><td>b13</td><td>TX2_BPM_MONITOR</td></tr> <tr><td>b14</td><td>SYNTH_FREQ_MONITOR</td></tr> <tr><td>b15</td><td>EXTERNAL_ANALOG_SIGNALS_MONITOR</td></tr> <tr><td>b16</td><td>INTERNAL_TX0_SIGNALS_MONITOR</td></tr> <tr><td>b17</td><td>INTERNAL_TX1_SIGNALS_MONITOR</td></tr> <tr><td>b18</td><td>INTERNAL_TX2_SIGNALS_MONITOR</td></tr> <tr><td>b19</td><td>INTERNAL_RX_SIGNALS_MONITOR</td></tr> <tr><td>b20</td><td>INTERNAL_PMCLKLO_SIGNALS_MONITOR</td></tr> <tr><td>b21</td><td>INTERNAL_GPADC_SIGNALS_MONITOR</td></tr> <tr><td>b22</td><td>PLL_CONTROL_VOLTAGE_MONITOR</td></tr> <tr><td>b23</td><td>DCC_CLOCK_FREQ_MONITOR</td></tr> <tr><td>b24</td><td>RX_SATURATION_DETECTOR_MONITOR</td></tr> <tr><td>b25</td><td>RX_SIG_IMG_BAND_MONITOR</td></tr> <tr><td>b26</td><td>RX_MIXER_INPUT_POWER_MONITOR</td></tr> <tr><td>b27</td><td>RESERVED</td></tr> <tr><td>b28</td><td>SYNTH_FREQ_MONITOR_NON_LIVE</td></tr> <tr><td>b31:29</td><td>RESERVED</td></tr> </tbody> </table>	Bit	Definition	b0	TEMPERATURE_MONITOR	b1	RX_GAIN_PHASE_MONITOR	b2	RX_NOISE_FIGURE_MONITOR	b3	RX_IFSTAGE_MONITOR	b4	TX0_POWER_MONITOR	b5	TX1_POWER_MONITOR	b6	TX2_POWER_MONITOR	b7	TX0_BALLBREAK_MONITOR	b8	TX1_BALLBREAK_MONITOR	b9	TX2_BALLBREAK_MONITOR	b10	TX_GAIN_PHASE_MISMATCH_MONITOR	b11	TX0_BPM_MONITOR	b12	TX1_BPM_MONITOR	b13	TX2_BPM_MONITOR	b14	SYNTH_FREQ_MONITOR	b15	EXTERNAL_ANALOG_SIGNALS_MONITOR	b16	INTERNAL_TX0_SIGNALS_MONITOR	b17	INTERNAL_TX1_SIGNALS_MONITOR	b18	INTERNAL_TX2_SIGNALS_MONITOR	b19	INTERNAL_RX_SIGNALS_MONITOR	b20	INTERNAL_PMCLKLO_SIGNALS_MONITOR	b21	INTERNAL_GPADC_SIGNALS_MONITOR	b22	PLL_CONTROL_VOLTAGE_MONITOR	b23	DCC_CLOCK_FREQ_MONITOR	b24	RX_SATURATION_DETECTOR_MONITOR	b25	RX_SIG_IMG_BAND_MONITOR	b26	RX_MIXER_INPUT_POWER_MONITOR	b27	RESERVED	b28	SYNTH_FREQ_MONITOR_NON_LIVE	b31:29	RESERVED
Bit	Definition																																																															
b0	TEMPERATURE_MONITOR																																																															
b1	RX_GAIN_PHASE_MONITOR																																																															
b2	RX_NOISE_FIGURE_MONITOR																																																															
b3	RX_IFSTAGE_MONITOR																																																															
b4	TX0_POWER_MONITOR																																																															
b5	TX1_POWER_MONITOR																																																															
b6	TX2_POWER_MONITOR																																																															
b7	TX0_BALLBREAK_MONITOR																																																															
b8	TX1_BALLBREAK_MONITOR																																																															
b9	TX2_BALLBREAK_MONITOR																																																															
b10	TX_GAIN_PHASE_MISMATCH_MONITOR																																																															
b11	TX0_BPM_MONITOR																																																															
b12	TX1_BPM_MONITOR																																																															
b13	TX2_BPM_MONITOR																																																															
b14	SYNTH_FREQ_MONITOR																																																															
b15	EXTERNAL_ANALOG_SIGNALS_MONITOR																																																															
b16	INTERNAL_TX0_SIGNALS_MONITOR																																																															
b17	INTERNAL_TX1_SIGNALS_MONITOR																																																															
b18	INTERNAL_TX2_SIGNALS_MONITOR																																																															
b19	INTERNAL_RX_SIGNALS_MONITOR																																																															
b20	INTERNAL_PMCLKLO_SIGNALS_MONITOR																																																															
b21	INTERNAL_GPADC_SIGNALS_MONITOR																																																															
b22	PLL_CONTROL_VOLTAGE_MONITOR																																																															
b23	DCC_CLOCK_FREQ_MONITOR																																																															
b24	RX_SATURATION_DETECTOR_MONITOR																																																															
b25	RX_SIG_IMG_BAND_MONITOR																																																															
b26	RX_MIXER_INPUT_POWER_MONITOR																																																															
b27	RESERVED																																																															
b28	SYNTH_FREQ_MONITOR_NON_LIVE																																																															
b31:29	RESERVED																																																															

Continued on next page

Table 8.3 – continued from previous page

LDO_SC_MONITORING_EN	4	<p>If any bit in this field is set to 1, the associated monitors are enabled. There are no reports for these monitors. If there is any fault, the async event AWR_ANALOGFAULT_AE_SB will be sent.</p> <p>Bit Description</p> <p>b0 APLL LDO short circuit monitoring enable 0 – disable, 1 – enable</p> <p>b1 SYNTH VCO LDO short circuit monitoring enable 0 – disable, 1 – enable</p> <p>b2 PA LDO short circuit monitoring enable 0 – disable, 1 – enable</p> <p>b31:3 RESERVED</p> <p>Note: This feature is not supported in DFP 1.x (1st generation devices). Please refer latest DFP release note for more details</p>
----------------------	---	-----------------------------------------------------------------------------------------------------------------------------------------------------------------------------------------------------------------------------------------------------------------------------------------------------------------------------------------------------------------------------------------------------------------------------------------------------------------------------------------------------------------------------------------------------------------------------------------------------------------------------------------------------------------

8.2 Temperature Monitor

This section contains API SBs that configure the on chip temperature monitors and report the soft results from the monitor. The corresponding monitors are collectively named TEMPERATURE_MONITOR. These monitors observe the temperature near various RF analog and digital modules using temperature sensors and GPADC and compare them against configurable thresholds. The report is sent as an async event [AWR_MONITOR_TEMPERATURE_REPORT_AE_SB](#).

8.2.1 Sub block 0x01C3 – AWR_MONITOR_TEMPERATURE_CONF_SB

This API is a monitoring configuration API which the host sends to the AWR device, containing information related to temperature monitoring. Report of this monitoring will be available in the async event [AWR_MONITOR_TEMPERATURE_REPORT_AE_SB](#).

Table 8.4: AWR_MONITOR_TEMPERATURE_CONF_SB contents

Field Name	Number of bytes	Description
SBLKID	2	Value = 0x01C3
SBLKLEN	2	Value = 24

Continued on next page

Table 8.4 – continued from previous page

REPORTING_	1	Value	Definition
MODE		0	Report is sent every monitoring period without threshold check
		1	Report is send only upon a failure (after checking for thresholds)
		2	Report is sent every monitoring period with threshold check
RESERVED	1	0x00	
ANA_TEMP_	2		The temperatures read from near the sensors near the RF analog modules are compared against a minimum threshold. The comparison result is part of the monitoring report message (Error bit is set if any measurement is outside this (minimum, maximum) range). 1 LSB = 1°C, signed number Valid range: -99°C to 199°C
THRESH_MIN			
ANA_TEMP_	2		The temperatures read from near the sensors near the RF analog modules are compared against a maximum threshold. The comparison result is part of the monitoring report message (Error bit is set if any measurement is outside this (minimum, maximum) range). 1 LSB = 1°C, signed number Valid range: -99°C to 199°C
THRESH_MAX			
DIG_TEMP_	2		The temperatures read from near the sensor near the digital module are compared against a minimum threshold. The comparison result is part of the monitoring report message (Error bit is set if any measurement is outside this (minimum, maximum) range). 1 LSB = 1°C, signed number Valid range: -99°C to 199°C
THRESH_MIN			
DIG_TEMP_	2		The temperatures read from near the sensor near the digital module are compared against a maximum threshold. The comparison result is part of the monitoring report message (Error bit is set if any measurement is outside this (minimum, maximum) range). 1 LSB = 1°C, signed number Valid range: -99°C to 199°C
THRESH_MAX			
TEMP_DIFF_	2		The maximum difference across temperatures read from all the enabled sensors is compared against this threshold. The comparison result is part of the monitoring report message (Error bit is set if the measured difference exceeds this field). 1 LSB = 1°C, unsigned number Valid range: 0°C to 100°C
THRESH			

Continued on next page

Table 8.4 – continued from previous page

RESERVED	4	0x00000000
RESERVED	4	0x00000000

8.3 RX Gain and Phase Monitor

This section contains API SBs that configure the monitors of receiver gain and phase. The corresponding monitors are collectively named RX_GAIN_PHASE_MONITOR. The report is sent as an async event [AWR_MONITOR_RX_GAIN_PHASE_REPORT_AE_SB](#).

NOTE:	<p>It is recommended for the user to configure this monitor in verbose mode (Mode 0), so that Host can compute actual RX gain through temperature compensation and detect presence of interference using Noise Power.</p> <p>In quiet mode, the user may consider programming broad thresholds for Absolute Gain Error, taking into account the temperature variation of reported RX_GAIN_VALUE.</p>
--------------	------------------------------------------------------------------------------------------------------------------------------------------------------------------------------------------------------------------------------------------------------------------------------------------------------------------------------------------------------------------------------------------------------

8.3.1 Sub block 0x01C4 – AWR_MONITOR_RX_GAIN_PHASE_CONF_SB

This is a monitoring configuration API which the host sends to the AWR device, containing information related to RX gain and phase monitoring.

Table 8.5: AWR_MONITOR_RX_GAIN_PHASE_CONF_SB contents

Field Name	Number of bytes	Description
SBLKID	2	Value = 0x01C4
SBLKLEN	2	Value = 72
PROFILE_INDX	1	This field indicates the profile Index for which this monitoring configuration applies.

Continued on next page

Table 8.5 – continued from previous page

RF_FREQ_BIT-MASK	1	<p>This field indicates the RF frequencies inside the profile's RF band at which to measure the required parameters. When each bit in this field is set, the measurement at the corresponding RF frequency is enabled w.r.t. the profile's RF band.</p> <table border="1"> <thead> <tr> <th>Bit number</th> <th>RF frequency</th> <th>RF name</th> </tr> </thead> <tbody> <tr> <td>b0</td> <td>Lowest RF frequency in profile's sweep bandwidth</td> <td>RF1</td> </tr> <tr> <td>b1</td> <td>Center RF frequency in profile's sweep bandwidth</td> <td>RF2</td> </tr> <tr> <td>b2</td> <td>Highest RF frequency in profile's sweep bandwidth</td> <td>RF3</td> </tr> </tbody> </table> <p>The RF name column is mentioned here to set the convention for the purpose of reporting and describing many monitoring packets.</p>	Bit number	RF frequency	RF name	b0	Lowest RF frequency in profile's sweep bandwidth	RF1	b1	Center RF frequency in profile's sweep bandwidth	RF2	b2	Highest RF frequency in profile's sweep bandwidth	RF3
Bit number	RF frequency	RF name												
b0	Lowest RF frequency in profile's sweep bandwidth	RF1												
b1	Center RF frequency in profile's sweep bandwidth	RF2												
b2	Highest RF frequency in profile's sweep bandwidth	RF3												
REPORTING_MODE	1	<table border="1"> <thead> <tr> <th>Value</th> <th>Definition</th> </tr> </thead> <tbody> <tr> <td>0</td> <td>Report is sent every monitoring period without threshold check</td> </tr> <tr> <td>1</td> <td>Report is send only upon a failure (after checking for thresholds). It is recommended not to use quiet mode, as Host has to compute actual RX gain and need to monitor Noise power to detect presence of interference.</td> </tr> <tr> <td>2</td> <td>Report is sent every monitoring period with threshold check</td> </tr> </tbody> </table>	Value	Definition	0	Report is sent every monitoring period without threshold check	1	Report is send only upon a failure (after checking for thresholds). It is recommended not to use quiet mode, as Host has to compute actual RX gain and need to monitor Noise power to detect presence of interference.	2	Report is sent every monitoring period with threshold check				
Value	Definition													
0	Report is sent every monitoring period without threshold check													
1	Report is send only upon a failure (after checking for thresholds). It is recommended not to use quiet mode, as Host has to compute actual RX gain and need to monitor Noise power to detect presence of interference.													
2	Report is sent every monitoring period with threshold check													
TX_SEL	1	<table border="1"> <thead> <tr> <th>Value</th> <th>Definition</th> </tr> </thead> <tbody> <tr> <td>0</td> <td>TX0 is used for generating loopback signal for RX gain measurement</td> </tr> <tr> <td>1</td> <td>TX1 is used for generating loopback signal for RX gain measurement</td> </tr> </tbody> </table>	Value	Definition	0	TX0 is used for generating loopback signal for RX gain measurement	1	TX1 is used for generating loopback signal for RX gain measurement						
Value	Definition													
0	TX0 is used for generating loopback signal for RX gain measurement													
1	TX1 is used for generating loopback signal for RX gain measurement													
RX_GAIN_ABS_ERROR_THRESH	2	<p>The magnitude of difference between the programmed and measured RX gain for each enabled channel at each enabled RF frequency, is compared against this threshold. The comparison result is part of the monitoring report message (Error bit is set if any measurement is above this threshold).</p> <p>Before the comparison, the measured gains for each RF and RX are adjusted by subtracting the offset given in the RX_GAIN_MISMATCH_OFFSET_VALUE field 1 LSB = 0.1 dB Valid range: 0 to 65535 (0 to 6553dB)</p>												

Continued on next page

Table 8.5 – continued from previous page

RX_GAIN_MISMATCH_THRESH	2	<p>The magnitude of difference between measured RX gains across the enabled channels at each enabled RF frequency is compared against this threshold.</p> <p>The comparison result is part of the monitoring report message (Error bit is set if the measurement is above this threshold).</p> <p>Before the comparison, the measured gains for each RF and RX are adjusted by subtracting the offset given in the RX_GAIN_MISMATCH_OFFSET_VALUE field.</p> <p>1 LSB = 0.1 dB</p> <p>Valid range: 0 to 65535 (0 to 6553dB)</p>
RX_GAIN_FLATNESS_ERROR_THRESH	2	<p>The magnitude of measured RX gain flatness error, for each enabled channel, is compared against this threshold. The flatness error for a channel is defined as the peak to peak variation across RF frequencies. The comparison result is part of the monitoring report message (Error bit is set if any measurement is above this threshold).</p> <p>Before the comparison, the measured gains for each RF and RX are adjusted by subtracting the offset given in the RX_GAIN_MISMATCH_OFFSET_VALUE field.</p> <p>1 LSB = 0.1 dB</p> <p>Valid range: 0 to 65535 (0 to 6553dB)</p> <p>This flatness check is applicable only if multiple RF Frequencies are enabled, i.e., RF_FREQ_BITMASK has bit numbers 0,1,2 set.</p>
RX_PHASE_MISMATCH_THRESH	2	<p>The magnitude of measured RX phase mismatch across the enabled channels at each enabled RF frequency is compared against this threshold.</p> <p>The comparison result is part of the monitoring report message (Error bit is set if any measurement is above this threshold).</p> <p>Before the comparison, the measured phases for each RF and RX are adjusted by subtracting the offset given in the RX_PHASE_MISMATCH_OFFSET_VALUE field.</p> <p>1 LSB = $360^\circ / 2^{16}$.</p> <p>Valid range: corresponding to 0° to 359.9°.</p>

Continued on next page

Table 8.5 – continued from previous page

RX_GAIN_MISMATCH_OFFSET_VALUE	24	<p>The offsets to be subtracted from the measured RX gain for each RX and RF before the relevant threshold comparisons are given here.</p> <p>Byte numbers corresponding to different RX and RF, in this field are here:</p> <table border="1"> <thead> <tr> <th></th> <th>RF1</th> <th>RF2</th> <th>RF3</th> </tr> </thead> <tbody> <tr> <td>RX0</td> <td>1:0</td> <td>9:8</td> <td>17:16</td> </tr> <tr> <td>RX1</td> <td>3:2</td> <td>11:10</td> <td>19:18</td> </tr> <tr> <td>RX2</td> <td>5:4</td> <td>13:12</td> <td>21:20</td> </tr> <tr> <td>RX3</td> <td>7:6</td> <td>15:14</td> <td>23:22</td> </tr> </tbody> </table> <p>1 LSB = 0.1 dB, signed number</p> <p>Only the entries of enabled RF Frequencies and enabled RX channels are considered.</p>		RF1	RF2	RF3	RX0	1:0	9:8	17:16	RX1	3:2	11:10	19:18	RX2	5:4	13:12	21:20	RX3	7:6	15:14	23:22
	RF1	RF2	RF3																			
RX0	1:0	9:8	17:16																			
RX1	3:2	11:10	19:18																			
RX2	5:4	13:12	21:20																			
RX3	7:6	15:14	23:22																			
RX_PHASE_MISMATCH_OFFSET_VALUE	24	<p>The offsets to be subtracted from the measured RX phase for each RX and RF before the relevant threshold comparisons are given here.</p> <table border="1"> <thead> <tr> <th></th> <th>RF1</th> <th>RF2</th> <th>RF3</th> </tr> </thead> <tbody> <tr> <td>RX0</td> <td>1:0</td> <td>9:8</td> <td>17:16</td> </tr> <tr> <td>RX1</td> <td>3:2</td> <td>11:10</td> <td>19:18</td> </tr> <tr> <td>RX2</td> <td>5:4</td> <td>13:12</td> <td>21:20</td> </tr> <tr> <td>RX3</td> <td>7:6</td> <td>15:14</td> <td>23:22</td> </tr> </tbody> </table> <p>1 LSB = $360^\circ / 2^{16}$, unsigned number</p> <p>Only the entries of enabled RF Frequencies and enabled RX channels are considered.</p>		RF1	RF2	RF3	RX0	1:0	9:8	17:16	RX1	3:2	11:10	19:18	RX2	5:4	13:12	21:20	RX3	7:6	15:14	23:22
	RF1	RF2	RF3																			
RX0	1:0	9:8	17:16																			
RX1	3:2	11:10	19:18																			
RX2	5:4	13:12	21:20																			
RX3	7:6	15:14	23:22																			
RESERVED	4	0x00000000																				
RESERVED	4	0x00000000																				

8.4 RX Noise Monitor

This section contains API SBs that configure the monitor of receiver noise, and report the soft results from the monitor. The corresponding monitor is named RX_NOISE_FIGURE_MONITOR. The report is sent as an async event [AWR_MONITOR_RX_NOISE_FIGURE_REPORT_AE_SB](#).

8.4.1 Sub block 0x01C5 – AWR_MONITOR_RX_NOISE_FIGURE_CONF_SB

This is a monitoring configuration API which the host sends to the AWR device, containing information related to RX noise monitoring of a profile.

NOTE: The RX Noise figure monitor API is not supported in this release. Please refer latest DFP release note for more info.

Table 8.6: AWR_MONITOR_RX_NOISE_FIGURE_CONF_SB contents

Field Name	Number of bytes	Description												
SBLKID	2	Value = 0x01C5												
SBLKLEN	2	Value = 16												
PROFILE_INDX	1	This field indicates the profile Index for which this monitoring configuration applies.												
RF_FREQ_BIT-MASK	1	<p>This field indicates the exact RF frequencies inside the profile's RF band at which to measure the required parameters. When each bit in this field is set, the measurement at the corresponding RF frequency is enabled w.r.t. the profile's RF band.</p> <table border="0"> <thead> <tr> <th>Bit number</th> <th>RF frequency</th> <th>RF name</th> </tr> </thead> <tbody> <tr> <td>b0</td> <td>Lowest RF frequency in profile's sweep bandwidth</td> <td>RF1</td> </tr> <tr> <td>b1</td> <td>Center RF frequency in profile's sweep bandwidth</td> <td>RF2</td> </tr> <tr> <td>b2</td> <td>Highest RF frequency in profile's sweep bandwidth</td> <td>RF3</td> </tr> </tbody> </table> <p>The RF name column is mentioned here to set the convention for the purpose of reporting and describing many monitoring packets.</p>	Bit number	RF frequency	RF name	b0	Lowest RF frequency in profile's sweep bandwidth	RF1	b1	Center RF frequency in profile's sweep bandwidth	RF2	b2	Highest RF frequency in profile's sweep bandwidth	RF3
Bit number	RF frequency	RF name												
b0	Lowest RF frequency in profile's sweep bandwidth	RF1												
b1	Center RF frequency in profile's sweep bandwidth	RF2												
b2	Highest RF frequency in profile's sweep bandwidth	RF3												
RESERVED	2	0x0000												
REPORTING_MODE	1	<table border="0"> <thead> <tr> <th>Value</th> <th>Definition</th> </tr> </thead> <tbody> <tr> <td>0</td> <td>Report is sent every monitoring period without threshold check</td> </tr> <tr> <td>1</td> <td>Report is send only upon a failure (after checking for thresholds)</td> </tr> <tr> <td>2</td> <td>Report is sent every monitoring period with threshold check</td> </tr> </tbody> </table>	Value	Definition	0	Report is sent every monitoring period without threshold check	1	Report is send only upon a failure (after checking for thresholds)	2	Report is sent every monitoring period with threshold check				
Value	Definition													
0	Report is sent every monitoring period without threshold check													
1	Report is send only upon a failure (after checking for thresholds)													
2	Report is sent every monitoring period with threshold check													
RESERVED	1	0x00												
RX_NOISE_FIGURE_THRESHOLD	2	<p>The measured RX input referred noise figure at the enabled RF frequencies, for all channels, is compared against this threshold. The comparison result is part of the monitoring report message (Error bit is set if any measurement is above this threshold).</p> <p>1 LSB = 0.1 dB Valid range: 0 to 65535 (0 to 6553dB)</p>												
RESERVED	4	0x00000000												

NOTE: The Rx gain and phase monitoring shall be enabled when enabling Rx noise figure Monitoring. This monitors only baseband noise figure.

8.5 RX IF Stage Monitor

This section contains API SBs that configure the monitors of receiver IF filter attenuation, and report the soft results from the monitor. The corresponding monitor is named RX_IFSTAGE_MONITOR. The report is sent as an async event [AWR_MONITOR_RX_IFSTAGE_REPORT_AE_SB](#).

8.5.1 Sub block 0x01C6 – AWR_MONITOR_RX_IFSTAGE_CONF_SB

This API is a monitoring configuration API which the host sends to the AWR device, containing information related to RX IF filter attenuation monitoring. The report is sent as as an async event [AWR_MONITOR_RX_IFSTAGE_REPORT_AE_SB](#).

Table 8.7: AWR_MONITOR_RX_IFSTAGE_CONF_SB contents

Field Name	Number of bytes	Description								
SBLKID	2	Value = 0x01C6								
SBLKLEN	2	Value = 20								
PROFILE_INDX	1	This field indicates the Profile Index for which this monitoring configuration applies.								
REPORTING_MODE	1	<table border="0"> <tr> <td>Value</td> <td>Definition</td> </tr> <tr> <td>0</td> <td>Report is sent every monitoring period without threshold check</td> </tr> <tr> <td>1</td> <td>Report is send only upon a failure (after checking for thresholds)</td> </tr> <tr> <td>2</td> <td>Report is sent every monitoring period with threshold check</td> </tr> </table>	Value	Definition	0	Report is sent every monitoring period without threshold check	1	Report is send only upon a failure (after checking for thresholds)	2	Report is sent every monitoring period with threshold check
Value	Definition									
0	Report is sent every monitoring period without threshold check									
1	Report is send only upon a failure (after checking for thresholds)									
2	Report is sent every monitoring period with threshold check									
RESERVED	2	0x0000								
RESERVED	2	0x0000								
HPF_CUTOFF_FREQ_ERROR_THRESH	2	<p>The absolute values of RX IF HPF cutoff percentage frequency errors are compared against the corresponding thresholds given in this field. The comparison results are part of the monitoring report message (Error bit is set if the absolute value of the errors exceeds respective thresholds).</p> <p>1 LSB = 1%, unsigned number Valid range: 1% to 128%</p>								

Continued on next page

Table 8.7 – continued from previous page

LPF_CUTOFF_FREQ_ERROR_THRESH	2	The absolute values of RX IF LPF cutoff percentage frequency errors are compared against the corresponding thresholds given in this field. The comparison results are part of the monitoring report message (Error bit is set if the absolute value of the errors exceeds respective thresholds). 1 LSB = 1%, unsigned number Valid range: 1% to 128% Note: This feature is not supported in this release. Please refer latest DFP release note for more details.
IFA_GAIN_ERROR_THRESH	2	The absolute deviation of RX IFA Gain from the expected gain for each enabled RX channel is compared against the thresholds given in this field. The comparison result is part of the monitoring report message (Error bit is set if the absolute value of the errors exceeds respective thresholds). 1 LSB = 0.1 dB, unsigned number Valid range: 0 to 65535 (0 to 6553dB)
RESERVED	4	0x00000000

8.6 TX Power Monitor

This section contains API SBs that configure the monitors of transmitter output power, and report the soft results from the monitor. The corresponding monitors are collectively named TXn_POWER_MONITOR where n is the TX channel number.

8.6.1 Sub block 0x01C7 – AWR_MONITOR_TX0_POWER_CONF_SB

This API is a monitoring configuration API which the host sends to the AWR device, containing information related to TX0 power monitoring. Absolute TX power and flatness across RF frequencies are monitored here. The report is sent as an async event [AWR_MONITOR_TX0_POWER_REPORT_AE_SB](#).

Table 8.8: AWR_MONITOR_TX0_POWER_CONF_SB contents

Field Name	Number of bytes	Description
SBLKID	2	Value = 0x01C7
SBLKLEN	2	Value = 20
PROFILE_INDX	1	This field indicates the Profile Index for which this monitoring configuration applies.

Continued on next page

Table 8.8 – continued from previous page

RF_FREQ_BIT-MASK	1	<p>This field indicates the exact RF frequencies inside the profile's RF band at which to measure the required parameters. When each bit in this field is set, the measurement at the corresponding RF frequency is enabled w.r.t. the profile's RF band.</p> <table border="1"> <thead> <tr> <th>Bit number</th> <th>RF frequency</th> <th>RF name</th> </tr> </thead> <tbody> <tr> <td>b0</td> <td>Lowest RF frequency in profile's sweep bandwidth</td> <td>RF1</td> </tr> <tr> <td>b1</td> <td>Center RF frequency in profile's sweep bandwidth</td> <td>RF2</td> </tr> <tr> <td>b2</td> <td>Highest RF frequency in profile's sweep bandwidth</td> <td>RF3</td> </tr> </tbody> </table> <p>The RF Name column is mentioned here to set the convention for the purpose of reporting and describing many monitoring packets.</p>	Bit number	RF frequency	RF name	b0	Lowest RF frequency in profile's sweep bandwidth	RF1	b1	Center RF frequency in profile's sweep bandwidth	RF2	b2	Highest RF frequency in profile's sweep bandwidth	RF3
Bit number	RF frequency	RF name												
b0	Lowest RF frequency in profile's sweep bandwidth	RF1												
b1	Center RF frequency in profile's sweep bandwidth	RF2												
b2	Highest RF frequency in profile's sweep bandwidth	RF3												
RESERVED	2	0x0000												
REPORTING_MODE	1	<table border="1"> <thead> <tr> <th>Value</th> <th>Definition</th> </tr> </thead> <tbody> <tr> <td>0</td> <td>Report is sent every monitoring period without threshold check</td> </tr> <tr> <td>1</td> <td>Report is send only upon a failure (after checking for thresholds)</td> </tr> <tr> <td>2</td> <td>Report is sent every monitoring period with threshold check</td> </tr> </tbody> </table>	Value	Definition	0	Report is sent every monitoring period without threshold check	1	Report is send only upon a failure (after checking for thresholds)	2	Report is sent every monitoring period with threshold check				
Value	Definition													
0	Report is sent every monitoring period without threshold check													
1	Report is send only upon a failure (after checking for thresholds)													
2	Report is sent every monitoring period with threshold check													
RESERVED	1	0x00												
TX_POWER_ABSOLUTE_ERROR_THRESH	2	<p>The magnitude of difference between the programmed and measured TX power for each enabled channel at each enabled RF frequency, is compared against this threshold. The comparison result is part of the monitoring report message (Error bit is set if any measurement is above this threshold).</p> <p>1 LSB = 0.1 dB Valid range: 0 to 65535 (0 to 6553dB)</p>												
TX_POWER_FLATNESS_ERROR_THRESH	2	<p>The magnitude of measured TX power flatness error, for each enabled channel, is compared against this threshold. The flatness error for a channel is defined as the peak to peak variation across RF frequencies. The comparison result is part of the monitoring report message (Error bit is set if any measurement is above this threshold).</p> <p>1 LSB = 0.1 dB Valid range: 0 to 65535 (0 to 6553dB)</p> <p>This flatness check is applicable only if multiple RF Frequencies are enabled.</p>												
RESERVED	2	0x0000												

Continued on next page

Table 8.8 – continued from previous page

RESERVED	4	0x00000000
----------	---	------------

8.6.2 Sub block 0x01C8 – AWR_MONITOR_TX1_POWER_CONF_SB

This API is a monitoring configuration API which the host sends to the AWR device, containing information related to TX1 power monitoring. Absolute TX power and flatness across RF frequencies are monitored here. The report is sent as an async event [AWR_MONITOR_TX1_POWER_REPORT_AE_SB](#).

Table 8.9: AWR_MONITOR_TX1_POWER_CONF_SB contents

Field Name	Number of bytes	Description												
SBLKID	2	Value = 0x01C8												
SBLKLEN	2	Value = 20												
PROFILE_INDX	1	This field indicates the Profile Index for which this monitoring configuration applies.												
RF_FREQ_BIT-MASK	1	<p>This field indicates the exact RF frequencies inside the profile's RF band at which to measure the required parameters. When each bit in this field is set, the measurement at the corresponding RF frequency is enabled w.r.t. the profile's RF band.</p> <table border="1"> <thead> <tr> <th>Bit number</th> <th>RF frequency</th> <th>RF name</th> </tr> </thead> <tbody> <tr> <td>b0</td> <td>Lowest RF frequency in profile's sweep bandwidth</td> <td>RF1</td> </tr> <tr> <td>b1</td> <td>Center RF frequency in profile's sweep bandwidth</td> <td>RF2</td> </tr> <tr> <td>b2</td> <td>Highest RF frequency in profile's sweep bandwidth</td> <td>RF3</td> </tr> </tbody> </table> <p>The RF Name column is mentioned here to set the convention for the purpose of reporting and describing many monitoring packets.</p>	Bit number	RF frequency	RF name	b0	Lowest RF frequency in profile's sweep bandwidth	RF1	b1	Center RF frequency in profile's sweep bandwidth	RF2	b2	Highest RF frequency in profile's sweep bandwidth	RF3
Bit number	RF frequency	RF name												
b0	Lowest RF frequency in profile's sweep bandwidth	RF1												
b1	Center RF frequency in profile's sweep bandwidth	RF2												
b2	Highest RF frequency in profile's sweep bandwidth	RF3												
RESERVED	2	0x0000												
REPORTING_MODE	1	<table border="1"> <thead> <tr> <th>Value</th> <th>Definition</th> </tr> </thead> <tbody> <tr> <td>0</td> <td>Report is sent every monitoring period without threshold check</td> </tr> <tr> <td>1</td> <td>Report is send only upon a failure (after checking for thresholds)</td> </tr> <tr> <td>2</td> <td>Report is sent every monitoring period with threshold check</td> </tr> </tbody> </table>	Value	Definition	0	Report is sent every monitoring period without threshold check	1	Report is send only upon a failure (after checking for thresholds)	2	Report is sent every monitoring period with threshold check				
Value	Definition													
0	Report is sent every monitoring period without threshold check													
1	Report is send only upon a failure (after checking for thresholds)													
2	Report is sent every monitoring period with threshold check													

Continued on next page

Table 8.9 – continued from previous page

RESERVED	1	0x00
TX_POWER_ABSOLUTE_ERROR_THRESH	2	The magnitude of difference between the programmed and measured TX power for each enabled channel at each enabled RF frequency, is compared against this threshold. The comparison result is part of the monitoring report message (Error bit is set if any measurement is above this threshold). 1 LSB = 0.1 dB Valid range: 0 to 65535 (0 to 6553dB)
TX_POWER_FLATNESS_ERROR_THRESH	2	The magnitude of measured TX power flatness error, for each enabled channel, is compared against this threshold. The flatness error for a channel is defined as the peak to peak variation across RF frequencies. The comparison result is part of the monitoring report message (Error bit is set if any measurement is above this threshold). 1 LSB = 0.1 dB Valid range:0 to 65535 (0 to 6553dB) This flatness check is applicable only if multiple RF Frequencies are enabled.
RESERVED	2	0x0000
RESERVED	4	0x00000000

8.6.3 Sub block 0x01C9 – AWR_MONITOR_TX2_POWER_CONF_SB

This API is a monitoring configuration API which the host sends to the AWR device, containing information related to TX2 power monitoring. Absolute TX power and flatness across RF frequencies are monitored here. The report is sent as an async event [AWR_MONITOR_TX2_POWER_REPORT_AE_SB](#).

Table 8.10: AWR_MONITOR_TX2_POWER_CONF_SB contents

Field Name	Number of bytes	Description
SBLKID	2	Value = 0x01C9
SBLKLEN	2	Value = 20
PROFILE_INDX	1	This field indicates the Profile Index for which this monitoring configuration applies.

Continued on next page

Table 8.10 – continued from previous page

RF_FREQ_BIT-MASK	1	<p>This field indicates the exact RF frequencies inside the profile's RF band at which to measure the required parameters. When each bit in this field is set, the measurement at the corresponding RF frequency is enabled w.r.t. the profile's RF band.</p> <table border="1"> <thead> <tr> <th>Bit number</th> <th>RF frequency</th> <th>RF name</th> </tr> </thead> <tbody> <tr> <td>b0</td> <td>Lowest RF frequency in profile's sweep bandwidth</td> <td>RF1</td> </tr> <tr> <td>b1</td> <td>Center RF frequency in profile's sweep bandwidth</td> <td>RF2</td> </tr> <tr> <td>b2</td> <td>Highest RF frequency in profile's sweep bandwidth</td> <td>RF3</td> </tr> </tbody> </table> <p>The RF Name column is mentioned here to set the convention for the purpose of reporting and describing many monitoring packets.</p>	Bit number	RF frequency	RF name	b0	Lowest RF frequency in profile's sweep bandwidth	RF1	b1	Center RF frequency in profile's sweep bandwidth	RF2	b2	Highest RF frequency in profile's sweep bandwidth	RF3
Bit number	RF frequency	RF name												
b0	Lowest RF frequency in profile's sweep bandwidth	RF1												
b1	Center RF frequency in profile's sweep bandwidth	RF2												
b2	Highest RF frequency in profile's sweep bandwidth	RF3												
RESERVED	2	0x0000												
REPORTING_MODE	1	<table border="1"> <thead> <tr> <th>Value</th> <th>Definition</th> </tr> </thead> <tbody> <tr> <td>0</td> <td>Report is sent every monitoring period without threshold check</td> </tr> <tr> <td>1</td> <td>Report is send only upon a failure (after checking for thresholds)</td> </tr> <tr> <td>2</td> <td>Report is sent every monitoring period with threshold check</td> </tr> </tbody> </table>	Value	Definition	0	Report is sent every monitoring period without threshold check	1	Report is send only upon a failure (after checking for thresholds)	2	Report is sent every monitoring period with threshold check				
Value	Definition													
0	Report is sent every monitoring period without threshold check													
1	Report is send only upon a failure (after checking for thresholds)													
2	Report is sent every monitoring period with threshold check													
RESERVED	1	0x00												
TX_POWER_ABSOLUTE_ERROR_THRESH	2	<p>The magnitude of difference between the programmed and measured TX power for each enabled channel at each enabled RF frequency, is compared against this threshold. The comparison result is part of the monitoring report message (Error bit is set if any measurement is above this threshold).</p> <p>1 LSB = 0.1 dB Valid range: 0 to 65535 (0 to 6553dB)</p>												
TX_POWER_FLATNESS_ERROR_THRESH	2	<p>The magnitude of measured TX power flatness error, for each enabled channel, is compared against this threshold. The flatness error for a channel is defined as the peak to peak variation across RF frequencies. The comparison result is part of the monitoring report message (Error bit is set if any measurement is above this threshold).</p> <p>1 LSB = 0.1 dB Valid range: 0 to 65535 (0 to 6553dB)</p> <p>This flatness check is applicable only if multiple RF Frequencies are enabled.</p>												
RESERVED	2	0x0000												

Continued on next page

Table 8.10 – continued from previous page

RESERVED	4	0x00000000
----------	---	------------

8.7 TX Ball Break Monitor

This section contains API SBs that configure the monitors of transmitter balls and impedance matching. The corresponding monitors are collectively named TX_n_BALLBREAK_MONITOR where n is the TX channel number.

TX ball break detection is performed through measurement of TX reflection coefficient's magnitude. The breakage of a TX ball is detected by observing high reflection magnitude.

8.7.1 Sub block 0x01CA – AWR_MONITOR_TX0_BALLBREAK_CONF_SB

This API is a monitoring configuration API which the host sends to the AWR device, containing information related to TX ball break detection.

This API SB controls the thresholds for the reflection coefficient magnitude check and the parameters for the reflection coefficient error distance check (variation from values at the time of factory calibration). The report is sent as an async event [AWR_MONITOR_TX0_BALLBREAK_REPORT_AE_SB](#).

Table 8.11: AWR_MONITOR_TX0_BALLBREAK_CONF_SB contents

Field Name	Number of bytes	Description
SBLKID	2	Value = 0x01CA
SBLKLEN	2	Value = 16
REPORTING_MODE	1	Value Definition 0 Report is sent every monitoring period without threshold check 1 Report is send only upon a failure (after checking for thresholds) 2 Report is sent every monitoring period with threshold check
RESERVED	1	0x00
TX_REFL_COEFF_THRESH	2	The TX reflection coefficient's magnitude for each enabled channel is compared against the threshold given here. The comparison result is part of the monitoring report message (Error bit is set if the measurement is higher than this threshold, with the units of both quantities being the same). 1 LSB = 0.1 dB, signed number Valid range: -32767 to +32767 (-3276dB to +3276dB)

Continued on next page

Table 8.11 – continued from previous page

MON_START_ FREQ_CONST	4	xWR1xxx devices: This field is reserved. Set to 0x0. xWR6x43 devices: Start frequency of the monitoring chirp. For 60GHz Devices (57GHz to 63.8GHz): 1 LSB = $2.7e9/2^{26}$ Hz \approx 40.233 Hz Valid range: 0x5471C71C to 0x5E84BDA1
RESERVED	4	0x00000000

8.7.2 Sub block 0x01CB – AWR_MONITOR_TX1_BALLBREAK_CONF_SB

This API is a monitoring configuration API which the host sends to the AWR device, containing information related to TX ball break detection.

This API SB controls the thresholds for the reflection coefficient magnitude check and the parameters for the reflection coefficient error distance check (variation from values at the time of factory calibration). The report is sent as an async event [AWR_MONITOR_TX1_BALLBREAK_REPORT_AE_SB](#).

Table 8.12: AWR_MONITOR_TX1_BALLBREAK_CONF_SB contents

Field Name	Number of bytes	Description
SBLKID	2	Value = 0x01CB
SBLKLEN	2	Value = 16
REPORTING_ MODE	1	Value Definition 0 Report is sent every monitoring period without threshold check 1 Report is send only upon a failure (after checking for thresholds) 2 Report is sent every monitoring period with threshold check
RESERVED	1	0x00
TX_REFL_CO- EFF_THRESH	2	The TX reflection coefficient's magnitude for each enabled channel is compared against the threshold given here. The comparison result is part of the monitoring report message (Error bit is set if the measurement is higher than this threshold, with the units of both quantities being the same). 1 LSB = 0.1 dB, signed number Valid range: -32767 to +32767 (-3276dB to +3276dB)

Continued on next page

Table 8.12 – continued from previous page

MON_START_ FREQ_CONST	4	xWR1xxx devices: This field is reserved. Set to 0x0. xWR6x43 devices: Start frequency of the monitoring chirp. For 60GHz Devices (57GHz to 63.8GHz): 1 LSB = $2.7e9/2^{26}$ Hz \approx 40.233 Hz Valid range: 0x5471C71C to 0x5E84BDA1
RESERVED	4	0x00000000

8.7.3 Sub block 0x01CC – AWR_MONITOR_TX2_BALLBREAK_CONF_SB

This API is a monitoring monfiguration API which the host sends to the AWR device, containing information related to TX ball break detection.

This API SB controls the thresholds for the reflection coefficient magnitude check and the parameters for the reflection coefficient error distance check (variation from values at the time of factory calibration). The report is sent as an async event [AWR_MONITOR_TX2_BALLBREAK_REPORT_AE_SB](#).

Table 8.13: AWR_MONITOR_TX2_BALLBREAK_CONF_SB contents

Field Name	Number of bytes	Description
SBLKID	2	Value = 0x01CC
SBLKLEN	2	Value = 16
REPORTING_ MODE	1	Value Definition 0 Report is sent every monitoring period without threshold check 1 Report is send only upon a failure (after checking for thresholds) 2 Report is sent every monitoring period with threshold check
RESERVED	1	0x00
TX_REFL_CO- EFF_THRESH	2	The TX reflection coefficient's magnitude for each enabled channel is compared against the threshold given here. The comparison result is part of the monitoring report message (Error bit is set if the measurement is higher or equal to this threshold, with the units of both quantities being the same). 1 LSB = 0.1 dB, signed number Valid range: -32767 to +32767 (-3276dB to +3276dB)

Continued on next page

Table 8.13 – continued from previous page

MON_START_ FREQ_CONST	4	xWR1xxx devices: This field is reserved. Set to 0x0. xWR6x43 devices: Start frequency of the monitoring chirp. For 60GHz Devices (57GHz to 63.8GHz): $1 \text{ LSB} = 2.7e9/2^{26} \text{ Hz} \approx 40.233 \text{ Hz}$ Valid range: 0x5471C71C to 0x5E84BDA1
RESERVED	4	0x00000000

8.8 TX Gain and Phase Mismatch Monitoring

This section contains API SBs that configure the monitors of transmitter gain and phase mismatches, and report the soft results from the monitor. The corresponding monitors are collectively named TX_GAIN_PHASE_MISMATCH_MONITOR.

This monitor needs the operation of at least one RX channel. It also needs to use the RX in complex mode. Therefore, if all channels are disabled as per AWR_CHAN_CONF_SET_SB, this monitor automatically enables one RX channel. Further, this monitor automatically uses both I and Q channels of the receiver, irrespective of the ADC settings given by AWR_ADCOUT_CONF_SET_SB.

NOTE: The TX gain and phase mismatch monitor API is not supported in this release. Please refer latest DFP release note for more info.

8.8.1 Sub block 0x01CD – AWR_MONITOR_TX_GAIN_PHASE_MISMATCH_CONF_SB

This API is a monitoring configuration API which the host sends to the AWR device, containing information related to TX gain and phase mismatch monitoring. The report is sent as an async event [AWR_MONITOR_TX_GAIN_PHASE_REPORT_AE_SB](#).

Table 8.14: AWR_MONITOR_TX_GAIN_PHASE_MISMATCH_CONF_SB contents

Field Name	Number of bytes	Description
SBLKID	2	Value = 0x01CD
SBLKLEN	2	Value = 56
PROFILE_INDX	1	This field indicates the Profile Index for which this monitoring configuration applies.

Continued on next page

Table 8.14 – continued from previous page

RF_FREQ_BIT-MASK	1	<p>This field indicates the exact RF frequencies inside the profile's RF band at which to measure the required parameters. When each bit in this field is set, the measurement at the corresponding RF frequency is enabled w.r.t. the profile's RF band.</p> <table border="1"> <thead> <tr> <th>Bit number</th> <th>RF frequency</th> <th>RF name</th> </tr> </thead> <tbody> <tr> <td>b0</td> <td>Lowest RF frequency in profile's sweep bandwidth</td> <td>RF1</td> </tr> <tr> <td>b1</td> <td>Center RF frequency in profile's sweep bandwidth</td> <td>RF2</td> </tr> <tr> <td>b2</td> <td>Highest RF frequency in profile's sweep bandwidth</td> <td>RF3</td> </tr> </tbody> </table> <p>The RF Name column is mentioned here to set the convention for the purpose of reporting and describing many monitoring packets.</p>	Bit number	RF frequency	RF name	b0	Lowest RF frequency in profile's sweep bandwidth	RF1	b1	Center RF frequency in profile's sweep bandwidth	RF2	b2	Highest RF frequency in profile's sweep bandwidth	RF3
Bit number	RF frequency	RF name												
b0	Lowest RF frequency in profile's sweep bandwidth	RF1												
b1	Center RF frequency in profile's sweep bandwidth	RF2												
b2	Highest RF frequency in profile's sweep bandwidth	RF3												
TX_EN	1	<p>This field indicates the TX channels that should be compared for gain and phase balance. Setting the corresponding bit to 1 enables that channel for imbalance measurement.</p> <table border="1"> <thead> <tr> <th>Bit number</th> <th>TX Channel</th> </tr> </thead> <tbody> <tr> <td>b0</td> <td>TX0</td> </tr> <tr> <td>b1</td> <td>TX1</td> </tr> <tr> <td>b2</td> <td>TX2</td> </tr> </tbody> </table>	Bit number	TX Channel	b0	TX0	b1	TX1	b2	TX2				
Bit number	TX Channel													
b0	TX0													
b1	TX1													
b2	TX2													
RX_EN	1	<p>This field indicates the RX channels that should be enabled for TX to RX loopback measurement. Setting the corresponding bit to 1 enables that channel for imbalance measurement.</p> <table border="1"> <thead> <tr> <th>Bit number</th> <th>RX Channel</th> </tr> </thead> <tbody> <tr> <td>b0</td> <td>RX0</td> </tr> <tr> <td>b1</td> <td>RX1</td> </tr> <tr> <td>b2</td> <td>RX2</td> </tr> <tr> <td>b3</td> <td>RX3</td> </tr> </tbody> </table>	Bit number	RX Channel	b0	RX0	b1	RX1	b2	RX2	b3	RX3		
Bit number	RX Channel													
b0	RX0													
b1	RX1													
b2	RX2													
b3	RX3													
REPORTING_MODE	1	<table border="1"> <thead> <tr> <th>Value</th> <th>Definition</th> </tr> </thead> <tbody> <tr> <td>0</td> <td>Report is sent every monitoring period without threshold check</td> </tr> <tr> <td>1</td> <td>Report is send only upon a failure (after checking for thresholds)</td> </tr> <tr> <td>2</td> <td>Report is sent every monitoring period with threshold check</td> </tr> </tbody> </table>	Value	Definition	0	Report is sent every monitoring period without threshold check	1	Report is send only upon a failure (after checking for thresholds)	2	Report is sent every monitoring period with threshold check				
Value	Definition													
0	Report is sent every monitoring period without threshold check													
1	Report is send only upon a failure (after checking for thresholds)													
2	Report is sent every monitoring period with threshold check													
RESERVED	1	0x00												

Continued on next page

Table 8.14 – continued from previous page

TX_GAIN_MISMATCH_THRESH	2	<p>The magnitude of difference between measured TX powers across the enabled channels at each enabled RF frequency is compared against this threshold.</p> <p>The comparison result is part of the monitoring report message (Error bit is set if the measurement is above this threshold).</p> <p>Before the comparison, the measured gains for each RF and RX are adjusted by subtracting the offset given in the TX_GAIN_MISMATCH_OFFSET_VALUE field.</p> <p>1 LSB = 0.1 dB, unsigned number Valid range: 0 to 65535 (0 to 6553dB)</p>																
TX_PHASE_MISMATCH_THRESH	2	<p>The magnitude of measured TX phase mismatch across the enabled channels at each enabled RF frequency is compared against this threshold.</p> <p>The comparison result is part of the monitoring report message (Error bit is set if any measurement is above this threshold).</p> <p>Before the comparison, the measured gains for each RF and RX are adjusted by subtracting the offset given in the TX_PHASE_MISMATCH_OFFSET_VALUE field.</p> <p>1 LSB = $360^\circ / 2^{16}$, unsigned number Valid range: corresponding to 0° to 359.9°.</p>																
TX_GAIN_MISMATCH_OFFSET_VALUE	18	<p>The offsets to be subtracted from the measured TX gain for each TX and RF before the relevant threshold comparisons are given here.</p> <p>Byte numbers corresponding to different RX and RF, in this field are here:</p> <table border="0" data-bbox="662 1209 1037 1366"> <thead> <tr> <th></th> <th>RF1</th> <th>RF2</th> <th>RF3</th> </tr> </thead> <tbody> <tr> <td>TX0</td> <td>1:0</td> <td>7:6</td> <td>13:12</td> </tr> <tr> <td>TX1</td> <td>3:2</td> <td>9:8</td> <td>15:14</td> </tr> <tr> <td>TX2</td> <td>5:4</td> <td>11:10</td> <td>17:16</td> </tr> </tbody> </table> <p>Only the entries of enabled RF Frequencies and enabled TX channels are considered.</p>		RF1	RF2	RF3	TX0	1:0	7:6	13:12	TX1	3:2	9:8	15:14	TX2	5:4	11:10	17:16
	RF1	RF2	RF3															
TX0	1:0	7:6	13:12															
TX1	3:2	9:8	15:14															
TX2	5:4	11:10	17:16															

Continued on next page

Table 8.14 – continued from previous page

TX_PHASE_MISMATCH_OFFSET_VALUE	18	<p>The offsets to be subtracted from the measured TX phase for each TX and RF before the relevant threshold comparisons are given here.</p> <p>Byte numbers corresponding to different RX and RF, in this field are here:</p> <table border="1"> <thead> <tr> <th></th> <th>RF1</th> <th>RF2</th> <th>RF3</th> </tr> </thead> <tbody> <tr> <td>TX0</td> <td>1:0</td> <td>7:6</td> <td>13:12</td> </tr> <tr> <td>TX1</td> <td>3:2</td> <td>9:8</td> <td>15:14</td> </tr> <tr> <td>TX2</td> <td>5:4</td> <td>11:10</td> <td>17:16</td> </tr> </tbody> </table> <p>1 LSB = $360^\circ / 2^{16}$.</p> <p>Only the entries of enabled RF Frequencies and enabled TX channels are considered.</p>		RF1	RF2	RF3	TX0	1:0	7:6	13:12	TX1	3:2	9:8	15:14	TX2	5:4	11:10	17:16
	RF1	RF2	RF3															
TX0	1:0	7:6	13:12															
TX1	3:2	9:8	15:14															
TX2	5:4	11:10	17:16															
RESERVED	2	0x0000																
RESERVED	4	0x00000000																

NOTE: Even when the TXs are matched, TX3 loopback path has gain and phase offsets wrt TX1 (and TX2), which get reported as mismatches in this API. These deterministic offsets can be compensated either through the OFFSET_VALUE fields (quiet mode) or through post processing by the host (verbose mode). Nominally, when the TXs are matched, TX3 - TX1 gain (i.e. loopback amplitude) is reported as -8dB. Nominally, when the TXs are matched, the reported TX3 - TX1 phase difference varies linearly with RF and it is reported as -5degree (76GHz) and 15degree (81GHz).

8.9 TX BPM Phase Monitor

This section contains API SBs that configure the monitors of transmitter binary phase modulation, and report the soft results from the monitor, for various TX channels. The corresponding monitors are collectively named TX0_BPM_MONITOR, TX1_BPM_MONITOR and TX2_BPM_MONITOR for the respective TX channels.

NOTE: The TX BPM monitor APIs are not supported in this release. Please refer latest DFP release note for more info.

8.9.1 Sub block 0x01CE – AWR_MONITOR_TX0_BPM_CONF_SB

This API is a monitoring configuration API which the host sends to the AWR device, containing information related to TX0 BPM monitoring.

The report is sent as an async event [AWR_MONITOR_TX0_BPM_REPORT_AE_SB](#).

Table 8.15: AWR_MONITOR_TX0_BPM_CONF_SB contents

Field Name	Number of bytes	Description
SBLKID	2	Value = 0x01CE
SBLKLEN	2	Value = 20
PROFILE_INDX	1	This field indicates the Profile Index for which this monitoring configuration applies.
PH_SHIFTER_MON_CFG	1	Bit Definition b7 Phase shifter monitoring enabled b6 Phase shifter monitoring increment enabled b5:0 Phase shifter monitoring increment value 1 LSB = 5.625° NOTE: Phase shifter monitoring control is not supported in this release for all devices. This is a RESERVED field and should be set to 0.
PH_SHIFTER_MON1	1	Phase1 of the phase shifter of TX0 which needs to be monitored 1 LSB = 5.625°
PH_SHIFTER_MON2	1	Phase2 of the phase shifter of TX0 which needs to be monitored 1 LSB = 5.625°
REPORTING_MODE	1	Value Definition 0 Report is sent every monitoring period without threshold check 1 Report is send only upon a failure (after checking for thresholds) 2 Report is sent every monitoring period with threshold check
RX_EN	1	This field indicates the RX channels that should be enabled for TX to RX loopback measurement. Setting the corresponding bit to 1 enables that channel for imbalance measurement. Bit number RX Channel b0 RX0 b1 RX1 b2 RX2 b3 RX3

Continued on next page

Table 8.15 – continued from previous page

TX_BPM_PHASE_ERROR_THRESH	2	The deviation of the TX output phase difference between the two BPM settings from the ideal 180° is compared against the threshold given here. The comparison result is part of the monitoring report message (Error bit is set if the measurement is higher than this threshold, with the units of both quantities being the same). 1 LSB = $360^\circ / 2^{16}$. Valid range: corresponding to 0° to 359.9°.
TX_BPM_AMPLITUDE_ERROR_THRESH	2	The deviation of the TX output amplitude difference between the two BPM settings is compared against the threshold given here. The comparison result is part of the monitoring report message (Error bit is set if the measurement is higher than this threshold, with the units of both quantities being the same). 1 LSB = 0.1 dB Valid range: 0 to 65535 (0 to 6553dB)
PH_SHIFTER_THRESH_MAX	2	Maximum threshold for the difference in the 2 configured phase shift values 1 LSB = 5.625°
PH_SHIFTER_THRESH_MIN	2	Minimum threshold for the difference in the 2 configured phase shift values 1 LSB = 5.625°
RESERVED	2	0x0000

8.9.2 Sub block 0x01CF – AWR_MONITOR_TX1_BPM_CONF_SB

This API is a monitoring configuration API which the host sends to the AWR device, containing information related to TX1 BPM monitoring. The report is sent as an async event [AWR_MONITOR_TX1_BPM_REPORT_AE_SB](#).

Table 8.16: AWR_MONITOR_TX1_BPM_CONF_SB contents

Field Name	Number of bytes	Description
SBLKID	2	Value = 0x01CF
SBLKLEN	2	Value = 20
PROFILE_INDX	1	This field indicates the Profile Index for which this monitoring configuration applies.

Continued on next page

Table 8.16 – continued from previous page

PH_SHIFTER_MON_CFG	1	<p>Bit Definition</p> <p>b7 Phase shifter monitoring enabled</p> <p>b6 Phase shifter monitoring increment enabled</p> <p>b5:0 Phase shifter monitoring increment value 1 LSB = 5.625°</p> <p>NOTE: Phase shifter monitoring control is not supported in this release for all devices. This is a RESERVED field and should be set to 0.</p>
PH_SHIFTER_MON1	1	<p>Phase1 of the phase shifter of TX1 which needs to be monitored</p> <p>1 LSB = 5.625°</p>
PH_SHIFTER_MON2	1	<p>Phase2 of the phase shifter of TX1 which needs to be monitored</p> <p>1 LSB = 5.625°</p>
REPORTING_MODE	1	<p>Value Definition</p> <p>0 Report is sent every monitoring period without threshold check</p> <p>1 Report is send only upon a failure (after checking for thresholds)</p> <p>2 Report is sent every monitoring period with threshold check</p>
RX_EN	1	<p>This field indicates the RX channels that should be enabled for TX to RX loopback measurement. Setting the corresponding bit to 1 enables that channel for imbalance measurement.</p> <p>Bit number RX Channel</p> <p>b0 RX0</p> <p>b1 RX1</p> <p>b2 RX2</p> <p>b3 RX3</p>
TX_BPM_PHASE_ERROR_THRESH	2	<p>The deviation of the TX output phase difference between the two BPM settings from the ideal 180° is compared against the threshold given here. The comparison result is part of the monitoring report message (Error bit is set if the measurement is higher than this threshold, with the units of both quantities being the same).</p> <p>1 LSB = 360°/2¹⁶.</p> <p>Valid range: corresponding to 0° to 359.9°.</p>

Continued on next page

Table 8.16 – continued from previous page

TX_BPM_AMPLITUDE_ERROR_THRESH	2	The deviation of the TX output amplitude difference between the two BPM settings is compared against the threshold given here. The comparison result is part of the monitoring report message (Error bit is set if the measurement is higher than this threshold, with the units of both quantities being the same). 1 LSB = 0.1 dB Valid range: 0 to 65535 (0 to 6553dB)
PH_SHIFTER_THRESH_MAX	2	Maximum threshold for the difference in the 2 configured phase shift values 1 LSB = 5.625°
PH_SHIFTER_THRESH_MIN	2	Minimum threshold for the difference in the 2 configured phase shift values 1 LSB = 5.625°
RESERVED	2	0x0000

8.9.3 Sub block 0x01D0 – AWR_MONITOR_TX2_BPM_CONF_SB

This API is a monitoring configuration API which the host sends to the AWR device, containing information related to TX2 BPM monitoring. The report is sent as an async event [AWR_MONITOR_TX2_BPM_REPORT_AE_SB](#).

Table 8.17: AWR_MONITOR_TX2_BPM_CONF_SB contents

Field Name	Number of bytes	Description								
SBLKID	2	Value = 0x01D0								
SBLKLEN	2	Value = 20								
PROFILE_INDX	1	This field indicates the Profile Index for which this monitoring configuration applies.								
PH_SHIFTER_MON_CFG	1	<table border="0"> <tr> <td>Bit</td> <td>Definition</td> </tr> <tr> <td>b7</td> <td>Phase shifter monitoring enabled</td> </tr> <tr> <td>b6</td> <td>Phase shifter monitoring increment enabled</td> </tr> <tr> <td>b5:0</td> <td>Phase shifter monitoring increment value 1 LSB = 5.625°</td> </tr> </table> NOTE: Phase shifter monitoring control is not supported in this release for all devices. This is a RESERVED field and should be set to 0.	Bit	Definition	b7	Phase shifter monitoring enabled	b6	Phase shifter monitoring increment enabled	b5:0	Phase shifter monitoring increment value 1 LSB = 5.625°
Bit	Definition									
b7	Phase shifter monitoring enabled									
b6	Phase shifter monitoring increment enabled									
b5:0	Phase shifter monitoring increment value 1 LSB = 5.625°									
PH_SHIFTER_MON1	1	Phase1 of the phase shifter of TX2 which needs to be monitored 1 LSB = 5.625°								

Continued on next page

Table 8.17 – continued from previous page

PH_SHIFTER_MON2	1	Phase2 of the phase shifter of TX2 which needs to be monitored 1 LSB = 5.625°										
REPORTING_MODE	1	<table border="0"> <thead> <tr> <th>Value</th> <th>Definition</th> </tr> </thead> <tbody> <tr> <td>0</td> <td>Report is sent every monitoring period without threshold check</td> </tr> <tr> <td>1</td> <td>Report is send only upon a failure (after checking for thresholds)</td> </tr> <tr> <td>2</td> <td>Report is sent every monitoring period with threshold check</td> </tr> </tbody> </table>	Value	Definition	0	Report is sent every monitoring period without threshold check	1	Report is send only upon a failure (after checking for thresholds)	2	Report is sent every monitoring period with threshold check		
Value	Definition											
0	Report is sent every monitoring period without threshold check											
1	Report is send only upon a failure (after checking for thresholds)											
2	Report is sent every monitoring period with threshold check											
RX_EN	1	<p>This field indicates the RX channels that should be enabled for TX to RX loopback measurement. Setting the corresponding bit to 1 enables that channel for imbalance measurement.</p> <table border="0"> <thead> <tr> <th>Bit number</th> <th>RX Channel</th> </tr> </thead> <tbody> <tr> <td>b0</td> <td>RX0</td> </tr> <tr> <td>b1</td> <td>RX1</td> </tr> <tr> <td>b2</td> <td>RX2</td> </tr> <tr> <td>b3</td> <td>RX3</td> </tr> </tbody> </table>	Bit number	RX Channel	b0	RX0	b1	RX1	b2	RX2	b3	RX3
Bit number	RX Channel											
b0	RX0											
b1	RX1											
b2	RX2											
b3	RX3											
TX_BPM_PHASE_ERROR_THRESH	2	<p>The deviation of the TX output phase difference between the two BPM settings from the ideal 180° is compared against the threshold given here. The comparison result is part of the monitoring report message (Error bit is set if the measurement is higher than this threshold, with the units of both quantities being the same).</p> <p>1 LSB = 360°/2¹⁶.</p> <p>Valid range: corresponding to 0° to 359.9°.</p>										
TX_BPM_AMPLITUDE_ERROR_THRESH	2	<p>The deviation of the TX output amplitude difference between the two BPM settings is compared against the threshold given here. The comparison result is part of the monitoring report message (Error bit is set if the measurement is higher than this threshold, with the units of both quantities being the same).</p> <p>1 LSB = 0.1 dB</p> <p>Valid range: 0 to 65535 (0 to 6553dB)</p>										
PH_SHIFTER_THRESH_MAX	2	<p>Maximum threshold for the difference in the 2 configured phase shift values</p> <p>1 LSB = 5.625°</p>										
PH_SHIFTER_THRESH_MIN	2	<p>Minimum threshold for the difference in the 2 configured phase shift values</p> <p>1 LSB = 5.625°</p>										
RESERVED	2	0x0000										

8.10 Synthesizer Frequency Monitoring

This section contains API SBs that configure the monitors of synthesizer chirp frequency, and report the soft results from the monitor. The corresponding monitor is named SYNTH_FREQ_MONITOR.

8.10.1 Sub block 0x01D1 – AWR_MONITOR_SYNTHESIZER_FREQUENCY_CONF_SB

This API is a monitoring configuration API which the host sends to the AWR device, containing information related to synthesizer frequency monitoring during chirping. The report is sent as an async event [AWR_MONITOR_SYNTH_FREQUENCY_REPORT_AE_SB](#) for live monitor and [AWR_MONITOR_SYNTHESIZER_FREQUENCY_NONLIVE_REPORT_AE_SB](#) for nonlive monitor (This is a new feature addition in **xWR6843** device only).

NOTE: The synth non-live mode monitor (Applicable to xWR6843 device only) internally generates a test chirp based on the profile associated with it. In order to limit its execution time, if the profile's ramp time exceeds 60us, the test chirp's ramp time is limited to 60us and the chirp slope is scaled to cover the profile's intended RF bandwidth.

Table 8.18: AWR_MONITOR_SYNTHESIZER_FREQUENCY_CONF_SB contents

Field Name	Number of bytes	Description								
SBLKID	2	Value = 0x01D1								
SBLKLEN	2	Value = 16								
PROFILE_INDX	1	This field indicates the Profile Index for which this monitoring configuration applies.								
REPORTING_MODE	1	<table border="0"> <tr> <td>Value</td> <td>Definition</td> </tr> <tr> <td>0</td> <td>Report is sent every monitoring period without threshold check</td> </tr> <tr> <td>1</td> <td>Report is send only upon a failure (after checking for thresholds)</td> </tr> <tr> <td>2</td> <td>Report is sent every monitoring period with threshold check</td> </tr> </table>	Value	Definition	0	Report is sent every monitoring period without threshold check	1	Report is send only upon a failure (after checking for thresholds)	2	Report is sent every monitoring period with threshold check
Value	Definition									
0	Report is sent every monitoring period without threshold check									
1	Report is send only upon a failure (after checking for thresholds)									
2	Report is sent every monitoring period with threshold check									

Continued on next page

Table 8.18 – continued from previous page

FREQ_ERROR_THRESH	2	<p>During the chirp, the error of the measured instantaneous chirp frequency w.r.t. the desired value is continuously compared against this threshold. The comparison result is part of the monitoring report message (Error bit is set if the measurement is above this threshold, ever during the previous monitoring period).</p> <p>1 LSB = 10 kHz Valid range: 0 to 65535 (0 to 655MHz)</p>
MONITOR_START_TIME	1	<p>This field determines when the monitoring starts in each chirp relative to the start of the ramp.</p> <p>1 LSB = 0.2 μs, signed number Valid range: -25 to 25 μs Recommended value: 6 μs or above</p>
MONITOR_CONFIG_MODE	1	<p>This field is applicable only for xWR6843 device. This field configures whether this monitor should be done for functional active chirps (mode 0) or non live monitor chirps. In case of non live monitor, the configuration needs to be sent twice for two VCOs (use mode 1 and 2).</p> <p>Value Definition</p> <p>0 LIVE_CONFIG (Default), The profile configuration for live mode is picked from this API, supported only in master/single-chip mode.</p> <p>1 VCO1_CONFIG, The profile configuration for Non-live mode is picked from this API for VCO1 monitor profile, supported in all modes (master, slave and single-chip).</p> <p>2 VCO2_CONFIG, The profile configuration for Non-live mode is picked from this API for VCO2 monitor profile, supported in all modes (master, slave and single-chip).</p> <p>Note: This feature is supported only on xWR6843 device.</p>
VCO_MON_EN	1	<p>This field is applicable only for xWR6843 device. This bit mask can be used to enable/disable the monitoring of non-live VCO profiles, this helps to control monitoring of only single VCO if needed. This setting should be same in both VCO settings.</p> <p>bits Definition</p> <p>b0 Enable VCO1 non-live monitor</p> <p>b1 Enable VCO2 non-live monitor</p> <p>b31:2 RESERVED</p>
RESERVED	1	0x000000
RESERVED	4	0x00000000

NOTE1:	(Live mode) It is recommended to re-issue this configuration API each time before enabling this monitor and frame trigger. The right sequence is as below: <ol style="list-style-type: none">1. Issue Synth frequency monitor configuration API.2. Enable Synth frequency monitor.3. Frame start.4. Frame stop.5. Frame start. (Optional in case of multiple frames)6. Frame stop. (Optional in case of multiple frames)7. Disable Synth frequency monitor (in case disabled for some reason)8. Issue Synth frequency monitor configuration API.9. Enable Synth frequency monitor.10. Frame start.
NOTE2:	In non live mode, this API can be issued twice with MONITOR_CONFIG_MODE value set to 1 and 2 for two different VCOs configured in different profiles respectively. The consolidated report for two VCOs in non-live mode is sent in a separate AE AWR_MONITOR_SYNTHESIZER_FREQUENCY_NONLIVE_REPORT_AE_SB
NOTE3:	In non live mode, the reporting mode and VCO_MON_EN for two VCO configurations should be same.

8.11 External Analog Signals Monitor

This section contains API SBs that configure the monitors of external analog signals which are input to the device through pins ANALOGTEST1-4, ANAMUX and VSENSE (also called ADC1-6) and report the soft results from the monitor. The corresponding monitors are collectively named EXTERNAL_ANALOG_SIGNALS_MONITOR. These monitors observe various analog signals input on the pins ADC1-6 using a GPADC and compare them against internally fixed thresholds.

8.11.1 Sub block 0x01D2 – AWR_MONITORING_EXTERNAL_ANALOG_SIGNALS_CONF_SB

This API is a monitoring configuration API which the host sends to the AWR device, containing information related to external DC signals monitoring (available only in xWR1642/xWR6843/xWR1843). The report is sent as an async event [AWR_MONITOR_EXTERNAL_ANALOG_SIGNALSREPORT_AE_SB](#).

Table [8.19](#) describes the content of this sub block.

Table 8.19: AWR_MONITOR_EXTERNAL_ANALOG_SIGNALS_CONF_SB
 contents

Field Name	Number of bytes	Description
SBLKID	2	Value = 0x01D2
SBLKLEN	2	Value = 36
REPORTING_MODE	1	Value Definition 0 Report is sent every monitoring period without threshold check 1 Report is send only upon a failure (after checking for thresholds) 2 Report is sent every monitoring period with threshold check
RESERVED	1	0x00
SIGNAL_INPUT_ENABLES	1	This field indicates the sets of externally fed DC signals which are to be monitored using GPADC. When each bit in this field is set, the corresponding signal is monitored. The monitored signals are compared against programmed limits. The comparison result is part of the monitoring report message. Bit Location SIGNAL b0 ANALOGTEST1 b1 ANALOGTEST2 b2 ANALOGTEST3 b3 ANALOGTEST4 b4 ANAMUX b5 VSENSE Others RESERVED

Continued on next page

Table 8.19 – continued from previous page

SIGNAL_BUFFER_ENABLEDS	1	<p>This field indicates the sets of externally fed DC signals which are to be buffered before being fed to the GPADC. When each bit in this field is set, the corresponding signal is buffered before the GPADC. The monitored signals are compared against programmed limits. The comparison result is part of the monitoring report message.</p> <p>Bit SIGNAL</p> <p>b0 ANALOGTEST1</p> <p>b1 ANALOGTEST2</p> <p>b2 ANALOGTEST3</p> <p>b3 ANALOGTEST4</p> <p>b4 ANAMUX</p> <p>Others RESERVED</p>
SIGNAL_SETTLING_TIME	6	<p>After connecting an external signal to the GPADC, the amount of time to wait for it to settle before taking GPADC samples is programmed in this field. For each signal, after that settling time, GPADC measurements take place for 6.4 μs (averaging 4 samples of the GPADC output). The byte locations of the settling times for each signal are tabulated here:</p> <p>Byte SIGNAL</p> <p>Loca- tion</p> <p>0 ANALOGTEST1</p> <p>1 ANALOGTEST2</p> <p>2 ANALOGTEST3</p> <p>3 ANALOGTEST4</p> <p>4 ANAMUX</p> <p>5 VSENSE</p> <p>1 LSB = 0.8 μs</p> <p>Valid range: 0 to 12 μs</p> <p>Valid programming condition: all the signals that are enabled should take a total of < 100 μs, including the programmed settling times and a fixed 6.4 μs of measurement time per enabled signal.</p>

Continued on next page

Table 8.19 – continued from previous page

SIGNAL_THRESH	12	<p>The external DC signals measured on GPADC are compared against these minimum and maximum thresholds. The comparison result is part of the monitoring report message (Error bit is set if any measurement is outside this (minimum, maximum) range).</p> <p>Byte Location Threshold SIGNAL</p> <p>0 Minimum ANALOGTEST1</p> <p>1 Minimum ANALOGTEST2</p> <p>2 Minimum ANALOGTEST3</p> <p>3 Minimum ANALOGTEST4</p> <p>4 Minimum ANAMUX</p> <p>5 Minimum VSENSE</p> <p>6 Maximum ANALOGTEST1</p> <p>7 Maximum ANALOGTEST2</p> <p>8 Maximum ANALOGTEST3</p> <p>9 Maximum ANALOGTEST4</p> <p>10 Maximum ANAMUX</p> <p>11 Maximum VSENSE</p> <p>1 LSB = 1.8V/256</p> <p>Valid range: 0 to 255</p>
RESERVED	2	0x0000
RESERVED	4	0x00000000
RESERVED	4	0x00000000

8.12 Internal Analog Signals Monitor

This section contains API SBs that configure the monitors of internal analog signals in the RF analog modules and report the soft results from the monitor. The corresponding monitors are collectively named INTERNAL_ANALOG_SIGNALS_MONITOR. These monitors observe various analog nodes in the RF and analog modules using a GPADC and compare them against internally fixed thresholds.

The configuration API SBs are organized to address various analog circuits as follows:

1. TX0 Internal Analog Signals Monitoring
 - a. This monitor is called INTERNAL_TX0_SIGNALS_MONITOR.
 - b. Signal sets that are monitored: (SUPPLY_TX, PWRDET_TX)
2. TX1 Internal Analog Signals Monitoring

- a. This monitor is called INTERNAL_TX1_SIGNALS_MONITOR
 - b. Signal sets that are monitored: (SUPPLY_TX, PWRDET_TX)
3. TX2 Internal Analog Signals Monitoring
 - a. This monitor is called INTERNAL_TX2_SIGNALS_MONITOR
 - b. Signal sets that are monitored: (SUPPLY_TX, PWRDET_TX)
 4. RX Internal Analog Signals Monitoring
 - a. This monitor is called INTERNAL_RX_SIGNALS_MONITOR
 - b. Signal sets that are monitored: (SUPPLY_RX, PWRDET_RX, DCBIAS_RX)
 5. PM CLK LO Internal Analog Signals Monitoring
 - a. This monitor is called INTERNAL_PMCLKLO_SIGNALS_MONITOR
 - b. Signal sets that are monitored: (SUPPLY_PMCLKLO, PWRDET_PMCLKLO, DCBIAS_PMCLKLO)
 6. GPADC Internal Analog Signals Monitoring
 - a. This monitor is called INTERNAL_GPADC_SIGNALS_MONITOR
 - b. Signal sets that are monitored: (GPADC_REF1, GPADC_REF2)

The results are reported in the corresponding REPORT API SBs in this section.

8.12.1 Sub block 0x01D3 – AWR_MONITOR_TX0_INTERNAL_ANALOG_SIGNALS_CONF_SB

This API is a monitoring configuration API which the host sends to the AWR device, containing information related to TX0 Internal Analog Signals monitoring including Tx Phase shifter DAC monitor (This is a new feature addition in **xWR6843** and **xWR1843** only). The report is sent as an async event [AWR_MONITOR_TX0_INTERNAL_ANALOG_SIGNALS_REPORT_AE_SB](#).

Table 8.20: AWR_MONITOR_TX0_INTERNAL_ANALOG_SIGNALS_CONF_SB contents

Field Name	Number of bytes	Description
SBLKID	2	Value = 0x01D3
SBLKLEN	2	Value = 12
PROFILE_INDEX	1	The RF analog settings corresponding to this profile are used for monitoring the enabled signals, using test chirps (static frequency, at the center of the profile's RF frequency band).

Continued on next page

Table 8.20 – continued from previous page

REPORTING_ MODE	1	Value	Definition
		0	RESERVED
		1	Report is send only upon a failure (after checking for thresholds)
		2	Report is sent every monitoring period with threshold check
TX_PS_DAC_ MON_THRESH	2	The TX phase shifter DAC monitor delta threshold Unit: 1 LSB = 1.8V/1024 This field is applicable only for xWR6843 and xWR1843 devices. Value 0: TX_PS_DAC_MON is disabled Valid Range: 1 to 1023	
RESERVED	4	0x00000000	

8.12.2 Sub block 0x01D4 – AWR_MONITOR_TX1_INTERNAL_ANALOG_SIGNALS_CONF_SB

This API is a monitoring configuration API which the host sends to the AWR device, containing information related to TX1 Internal Analog Signals monitoring including Tx Phase shifter DAC monitor (This is a new feature addition in **xWR6843** and **xWR1843** only). The report is sent as an async event [AWR_MONITOR_TX1_INTERNAL_ANALOG_SIGNALS_REPORT_AE_SB](#).

Table 8.21: AWR_MONITOR_TX1_INTERNAL_ANALOG_SIGNALS_CONF_SB contents

Field Name	Number of bytes	Description	
SBLKID	2	Value = 0x01D4	
SBLKLEN	2	Value = 12	
PROFILE_INDEX	1	The RF analog settings corresponding to this profile are used for monitoring the enabled signals, using test chirps (static frequency, at the center of the profile's RF frequency band).	
REPORTING_ MODE	1	Value	Definition
		0	RESERVED
		1	Report is send only upon a failure (after checking for thresholds)
		2	Report is sent every monitoring period with threshold check

Continued on next page

Table 8.21 – continued from previous page

TX_PS_DAC_MON_THRESH	2	The TX phase shifter DAC monitor delta threshold Unit: 1 LSB = 1.8V/1024 This field is applicable only for xWR6843 and xWR1843 devices. Value 0: TX_PS_DAC_MON is disabled Valid Range: 1 to 1023
RESERVED	4	0x00000000

8.12.3 Sub block 0x01D5 – AWR_MONITOR_TX2_INTERNAL_ANALOG_SIGNALS_CONF_SB

This API is a monitoring configuration API which the host sends to the AWR device, containing information related to TX2 Internal Analog Signals monitoring including Tx Phase shifter DAC monitor (This is a new feature addition in **xWR6843** and **xWR1843** only). The report is sent as an async event [AWR_MONITOR_TX2_INTERNAL_ANALOG_SIGNALS_REPORT_AE_SB](#).

Table 8.22: AWR_MONITOR_TX2_INTERNAL_ANALOG_SIGNALS_CONF_SB contents

Field Name	Number of bytes	Description								
SBLKID	2	Value = 0x01D5								
SBLKLEN	2	Value = 12								
PROFILE_INDEX	1	The RF analog settings corresponding to this profile are used for monitoring the enabled signals, using test chirps (static frequency, at the center of the profile's RF frequency band).								
REPORTING_MODE	1	<table border="0"> <tr> <td>Value</td> <td>Definition</td> </tr> <tr> <td>0</td> <td>RESERVED</td> </tr> <tr> <td>1</td> <td>Report is send only upon a failure (after checking for thresholds)</td> </tr> <tr> <td>2</td> <td>Report is sent every monitoring period with threshold check</td> </tr> </table>	Value	Definition	0	RESERVED	1	Report is send only upon a failure (after checking for thresholds)	2	Report is sent every monitoring period with threshold check
Value	Definition									
0	RESERVED									
1	Report is send only upon a failure (after checking for thresholds)									
2	Report is sent every monitoring period with threshold check									
TX_PS_DAC_MON_THRESH	2	The TX phase shifter DAC monitor delta threshold Unit: 1 LSB = 1.8V/1024 This field is applicable only for xWR6843 and xWR1843 devices. Value 0: TX_PS_DAC_MON is disabled Valid Range: 1 to 1023								
RESERVED	4	0x00000000								

8.12.4 Sub block 0x01D6 – AWR_MONITOR_RX_INTERNAL_ANALOG_SIGNALS_CONF_SB

This API is a monitoring configuration API which the host sends to the AWR device, containing information related to RX Internal Analog Signals monitoring. The report is sent as an async event [AWR_MONITOR_RX_INTERNAL_ANALOG_SIGNALS_REPORT_AE_SB](#).

Table 8.23: AWR_MONITOR_RX_INTERNAL_ANALOG_SIGNALS_CONF_SB contents

Field Name	Number of bytes	Description								
SBLKID	2	Value = 0x01D6								
SBLKLEN	2	Value = 12								
PROFILE_INDEX	1	The RF analog settings corresponding to this profile are used for monitoring the enabled signals, using test chirps (static frequency, at the center of the profile's RF frequency band).								
REPORTING_MODE	1	<table border="0"> <tr> <td>Value</td> <td>Definition</td> </tr> <tr> <td>0</td> <td>RESERVED</td> </tr> <tr> <td>1</td> <td>Report is send only upon a failure (after checking for thresholds)</td> </tr> <tr> <td>2</td> <td>Report is sent every monitoring period with threshold check</td> </tr> </table>	Value	Definition	0	RESERVED	1	Report is send only upon a failure (after checking for thresholds)	2	Report is sent every monitoring period with threshold check
Value	Definition									
0	RESERVED									
1	Report is send only upon a failure (after checking for thresholds)									
2	Report is sent every monitoring period with threshold check									
RESERVED	2	0x0000								
RESERVED	4	0x00000000								

8.12.5 Sub block 0x01D7 – AWR_MONITOR_PMCLKLO_INTERNAL_ANALOG_SIGNALS_CONF_SB

This API is a monitoring configuration API which the host sends to the AWR device, containing information related to Power Management, Clock generation and LO distribution circuits' Internal Analog Signals monitoring. The report is sent as an async event [AWR_MONITOR_PMCLKLO_INTERNAL_ANALOG_SIGNALS_REPORT_AE_SB](#).

Table 8.24: AWR_MONITOR_PMCLKLO_INTERNAL_ANALOG_SIGNALS_CONF_SB contents

Field Name	Number of bytes	Description
SBLKID	2	Value = 0x01D7
SBLKLEN	2	Value = 12

Continued on next page

Table 8.24 – continued from previous page

PROFILE_INDEX	1	The RF analog settings corresponding to this profile are used for monitoring the enabled signals, using test chirps (static frequency, at the center of the profile's RF frequency band).										
REPORTING_MODE	1	<table border="0"> <thead> <tr> <th>Value</th> <th>Definition</th> </tr> </thead> <tbody> <tr> <td>0</td> <td>RESERVED</td> </tr> <tr> <td>1</td> <td>Report is send only upon a failure (after checking for thresholds)</td> </tr> <tr> <td>2</td> <td>Report is sent every monitoring period with threshold check</td> </tr> </tbody> </table>	Value	Definition	0	RESERVED	1	Report is send only upon a failure (after checking for thresholds)	2	Report is sent every monitoring period with threshold check		
Value	Definition											
0	RESERVED											
1	Report is send only upon a failure (after checking for thresholds)											
2	Report is sent every monitoring period with threshold check											
SYNC_20G_SIG_SEL	1	This field is relevant only in cascade configuration and not applicable in single chip case <table border="0"> <thead> <tr> <th>Value</th> <th>Definition</th> </tr> </thead> <tbody> <tr> <td>0x00</td> <td>20GHz SYNC monitoring disabled</td> </tr> <tr> <td>0x01</td> <td>FMCW_SYNC_IN monitoring enabled</td> </tr> <tr> <td>0x02</td> <td>FMCW_SYNC_OUT monitoring enabled</td> </tr> <tr> <td>0x03</td> <td>FMCW_CLK_OUT monitoring enabled</td> </tr> </tbody> </table> NOTE: 20G signal monitoring control is not supported in this release for all devices. This is a RESERVED field and should be set to 0.	Value	Definition	0x00	20GHz SYNC monitoring disabled	0x01	FMCW_SYNC_IN monitoring enabled	0x02	FMCW_SYNC_OUT monitoring enabled	0x03	FMCW_CLK_OUT monitoring enabled
Value	Definition											
0x00	20GHz SYNC monitoring disabled											
0x01	FMCW_SYNC_IN monitoring enabled											
0x02	FMCW_SYNC_OUT monitoring enabled											
0x03	FMCW_CLK_OUT monitoring enabled											
SYNC_20G_MIN_THRESH	1	The minimum threshold value of monitoring, signed number Unit: 1 LSB = 1 dBm										
SYNC_20G_MAX_THRESH	1	The maximum threshold value of monitoring, signed number Unit: 1 LSB = 1 dBm										
RESERVED	3	0x000000										

8.12.6 Sub block 0x01D8 – AWR_MONITOR_GPADC_INTERNAL_ANALOG_SIGNALS_CONF_SB

This API is a monitoring configuration API which the host sends to the AWR device, containing information related to GPADC Internal Analog Signals monitoring. During this monitor, only the relevant circuits are ensured to be ON. The monitored signals are compared against internally chosen valid limits. The comparison result is part of the consolidated monitoring report message (Error bit for any signal set is set to 1 if any measurement in that signal set is beyond valid limits). The report is sent as an async event [AWR_MONITOR_GPADC_INTERNAL_ANALOG_SIGNALS_REPORT_AE_SB](#).

Table 8.25: AWR_MONITOR_GPADC_INTERNAL_ANALOG_SIGNALS_CONF_SB contents

Field Name	Number of bytes	Description								
SBLKID	2	Value = 0x01D8								
SBLKLEN	2	Value = 12								
REPORTING_MODE	1	<table border="0"> <tr> <td>Value</td> <td>Definition</td> </tr> <tr> <td>0</td> <td>RESERVED</td> </tr> <tr> <td>1</td> <td>Report is send only upon a failure (after checking for thresholds)</td> </tr> <tr> <td>2</td> <td>Report is sent every monitoring period with threshold check</td> </tr> </table>	Value	Definition	0	RESERVED	1	Report is send only upon a failure (after checking for thresholds)	2	Report is sent every monitoring period with threshold check
Value	Definition									
0	RESERVED									
1	Report is send only upon a failure (after checking for thresholds)									
2	Report is sent every monitoring period with threshold check									
RESERVED	3	0x000000								
RESERVED	4	0x00000000								

8.13 PLL Control Voltage Monitor

This section contains API SBs that configure the monitors of APLL and Synthesizer VCO control voltages and report the soft results from the monitor. The corresponding monitors are collectively named PLL_CONTROL_VOLTAGE_MONITOR. These monitors observe the VCO control voltages under various conditions using the GPADC and compare them against internally fixed thresholds. The transmitters are kept in OFF state during these measurements to avoid external emission.

8.13.1 Sub block 0x01D9 – AWR_MONITOR_PLL_CONTROL_VOLTAGE_SIGNALS_CONF_SB

This is a monitoring configuration API which the host sends to the AWR device, containing information related to APLL and Synthesizer's control voltage signals monitoring. The report is sent as an async event [AWR_MONITOR_PLL_CONTROL_VOLTAGE_REPORT_AE_SB](#).

Table 8.26: AWR_MONITOR_PLL_CONTROL_VOLTAGE_CONF_SB contents

Field Name	Number of bytes	Description
SBLKID	2	Value = 0x01D9
SBLKLEN	2	Value = 12

Continued on next page

Table 8.26 – continued from previous page

REPORTING_ MODE	1	Value Definition 0 Reserved 1 Report is send only upon a failure (after checking for thresholds) 2 Report is sent every monitoring period with threshold check
RESERVED	1	0x00
SIGNAL_EN- ABLES	2	This field indicates the sets of signals which are to be monitored. When each bit in this field is set, the corresponding signal set is monitored using test chirps. Rest of the RF analog may not be ON during these test chirps. The APLL VCO control voltage can be monitored. The Synthesizer VCO control voltage for both VCO1 and VCO2 can be monitored, while operating at their respective minimum and maximum frequencies, and their respective VCO slope (Hz/V) can be monitored if both frequencies are enabled for that VCO. The monitored signals are compared against internally chosen valid limits. The comparison results are part of the monitoring report message. Bit Location SIGNAL b0 APLL_VCTRL b1 SYNTH_VCO1_VCTRL b2 SYNTH_VCO2_VCTRL b15:3 RESERVED The synthesizer VCO extreme frequencies are: Synthesizer VCO Frequency Limits (Min, Max) VCO1 (76GHz, 78GHz) VCO2 (77GHz, 81GHz) Synthesizer measurements are done with TX switched off to avoid emissions.
RESERVED	4	0x00000000

8.14 Dual Clock Comparator Based Clock Frequency Monitor

This section contains API SBs that configure the Dual Clock Comparator based monitors of clocks in the BSS digital modules and report the soft results from the monitor. The corresponding monitors are collectively named DCC_CLOCK_FREQ_MONITOR. These monitors observe the relative frequency of various clock pairs and compare the measured relative frequency errors against internally fixed thresholds.

The various clock pairs that are monitored are defined here:

CLOCK PAIR	REFERENCE CLOCK	MEASURED CLOCK	ERROR THRESH-OLD (Tentative)
0	XTAL	BSS_600M	±1.0%
1	BSS_600M	BSS_200M	±1.0%
2	BSS_600M	BSS_100M	±1.0%
3	BSS_600M	GPADC_10M	±2.5%
4	BSS_600M	RCOSC_10M	±30.0%

The ideal frequencies of clocks involved in this monitor are given here:

Table 8.27: DCC Clock monitor pairs

CLOCK NAME	CLOCK FRE-QUENCY (MHz)	COMMENTS
XTAL	40	Crystal clock
BSS_600M	600	BSS root clock
BSS_200M	200	BSS processor clock
BSS_100M	100	BSS internal clock
GPADC_10M	10	GPADC clock used in monitoring and calibrations
RCOSC_10M	10 (±10%)	RC Oscillator clock

8.14.1 Sub block 0x01DA – AWR_MONITOR_DUAL_CLOCK_COMP_CONF_SB

This API is a monitoring configuration API which the host sends to the AWR device, containing information related to the DCC based clock frequency monitoring. The report is sent as an async event [AWR_MONITOR_DCC_DUAL_CLOCK_COMP_REPORT_AE_SB](#).

Table 8.28: AWR_MONITOR_DUAL_CLOCK_COMP_CONF_SB contents

Field Name	Number of bytes	Description
SBLKID	2	Value = 0x01DA
SBLKLEN	2	Value = 12

Continued on next page

Table 8.28 – continued from previous page

REPORTING_MODE	1	Value	Definition
		0	RESERVED check
		1	Report is send only upon a failure (after checking for thresholds)
		2	Report is sent every monitoring period with threshold check
RESERVED	1	0x00	
DCC_PAIR_ENABLES	2	This field indicates which pairs of clocks to monitor. When a bit in the field is set to 1, the firmware monitors the corresponding clock pair by deploying the hardware's Dual Clock Comparator in the corresponding DCC mode.	
		Bit	CLOCK PAIR
		b0	0 BSS_600M
		b1	1 BSS_200M
		b2	2 BSS_100M
		b3	3 GPADC_10M
		b4	4 RCOSC_10M
		b15:5	RESERVED
		The comparison results are part of the monitoring report message. The definition of the clock pairs and their error thresholds for failure reporting are given in the table below the message definition.	
RESERVED	4	0x00000000	

8.15 RX Saturation Detection Monitor

This section contains API SBs that configure the monitoring of RX analog saturation detectors, and report the results from the monitor. The corresponding monitors are collectively named RX_SATURATION_DETECTOR_MONITOR and RX_SIG_IMG_BAND_MONITOR. The report is available in CQ RAM.

8.15.1 Sub block 0x01DB – AWR_MONITOR_RX_SATURATION_DETECTOR_CONF_SB

This API is a monitoring configuration API which the host sends to the mmWave device, containing information related to RX saturation detector monitoring. The report is available as CQ2 (part of CQ) in CQ RAM every chirp. The application should transfer the report from CQ RAM every chirp.

Table 8.29: AWR_MONITOR_RX_SATURATION_DETECTOR_CONF_SB contents

Field Name	Number of bytes	Description
SBLKID	2	Value = 0x01DB
SBLKLEN	2	Value = 24
PROFILE_INDX	1	This field indicates the profile index for which this monitoring configuration applies.
SAT_MON_SELECT	1	01 – Enable only the ADC saturation monitor 11 – Enable both the ADC and IFA1 saturation monitors
RESERVED	1	0x00
RESERVED	1	0x00
SAT_MON_PRIMARY_TIME_SLICE_DURATION	2	It specifies the duration of each (primary) time slice. 1 LSB = 0.16 μ s. Valid range: 4 to floor(ADC sampling time us/0.16 μ s) NOTES: The minimum allowed duration of each (primary) time slice is 4 LSBs = 0.64 μ s. Also, the maximum number of (primary) time slices that will be monitored in a chirp is 64 so the recommendation is to set this value to correspond to (ADC sampling time / 64). If the slice is smaller, such that the ADC sampling time is longer than 64 primary slices, some regions of the valid duration of a chirp may go un-monitored.

Continued on next page

Table 8.29 – continued from previous page

SAT_MON_NUM_SLICES (N)	2	<p>Number of (primary + secondary) time slices to monitor. Valid range: 1 to 127</p> <p>NOTE1: Together with SAT_MON_PRIMARY_TIME_SLICE_DURATION, this determines the full duration of the ADC valid time that gets covered by the monitor. Primary slices = $(N+1) / 2$ Secondary slices = Primary slices - 1</p> <p>NOTE2:The total monitoring duration is recommended to be programmed slightly smaller than ADC sampling time to avoid last primary slice miss in the CQ data. If this recommendation is not followed and if ADC sampling time is less than total requested monitoring duration then no error is generated but the total number of slices reported back in CQ buffer would be a different value M, which is less than user requested value of N. In such cases, there will be $(M+1)/2$ primary slices and $(M-1)/2$ secondary slices. However, if ADC sampling time is such that Secondary $(M-1)/2$ can be measured and not Primary $(M+1)/2$, then primary slice $(M+1)/2$ will not be present in the CQ buffer. In such scenario, CQ buffer will have the total number of slices reported back as M-1 instead of M.</p>
SAT_MON_RX_CHANNEL_MASK	1	<p>Masks RX channels used for monitoring. In every slice, saturation counts for all unmasked channels are added together, and the total is capped to 127.</p> <p>The 8 bits are mapped (MSB->LSB) to: [RX3Q, RX2Q, RX1Q, RX0Q, RX3I, RX2I, RX1I, RX0I] 00000000 – All channels unmasked 11111111 – All channels masked</p>
RESERVED	1	0
RESERVED	1	0
RESERVED	1	0
RESERVED	4	0x00000000
RESERVED	4	0x00000000

8.15.2 Sub block 0x01DC – AWR_MONITOR_SIG_IMG_MONITOR_CONF_SB

This API is a monitoring configuration API which the host sends to the mmWave device, containing information related to signal and image band energy. The report is available as CQ1 (part of CQ) in CQ RAM. The application should transfer the report every chirp.

Table 8.30: AWR_MONITOR_RX_SIG_IMG_MONITOR_CONF_SB contents

Field Name	Number of bytes	Description
SBLKID	2	Value = 0x01DC
SBLKLEN	2	Value = 16
PROFILE_INDX	1	This field indicates the profile index for which this monitoring configuration applies.
SIG_IMG_MON_NUM_SLICES	1	Number of (primary + secondary) slices to monitor Valid range: 1 to 127
NUM_SAMPLES_PER_PRIMARY_TIME_SLICE	2	This field specifies the number of samples constituting each time slice. The minimum allowed value for this parameter is 4. Valid range: 4 to NUM_ADC_SAMPLES (see NOTE2 below) NOTE1: The maximum number of (primary) time slices that will be monitored in a chirp is 64, so our recommendation is that this value should at least equal (NUM_ADC_SAMPLES / 64). If the slice is smaller, such that the number of ADC samples per chirp is larger than 64 primary slices, some regions of the valid duration of a chirp may go un-monitored. NOTE2: In Complex1x mode, the minimum number of samples per slice is 4 and for other modes it is 8. Also note that number of samples should be an even number. NOTE3: The total monitoring duration is recommended to program slightly smaller than ADC sampling time
RESERVED	4	0x00000000
RESERVED	4	0x00000000

NOTE: It is recommended to re-issue these rx saturation and/or signal image monitor configuration APIs each time before enabling these monitor and frame trigger. The right sequence is as below:

1. Issue rx saturation and/or signal image monitor configuration API.
2. Enable rx saturation and/or signal image monitor.
3. Frame start.
4. Frame stop.
5. Frame start. (Optional in case of multiple frames)
6. Frame stop. (Optional in case of multiple frames)
7. Disable rx saturation and/or signal image monitor (in case disabled for some reason)
8. Issue rx saturation and/or signal image monitor configuration API.
9. Enable rx saturation and/or signal image monitor.
10. Frame start.

8.16 RX mixer input power monitor

8.16.1 Sub block 0x01DD – AWR_MONITOR_RX_MIXER_IN_POWER_CONF_SB

This API is a monitoring configuration API which the host sends to the AWR device, containing information related to RX mixer input power monitoring. The report is sent as an async event [AWR_MONITOR_RX_MIXER_IN_POWER_REPORT_AE_SB](#).

NOTE: The RX input power monitor API is debug only API. Please refer latest DFP release note for more info.

Table 8.31: AWR_MONITOR_MIXER_IN_POWER_CONF_SB contents

Field Name	Number of bytes	Description
SBLKID	2	Value = 0x01DD
SBLKLEN	2	Value = 16
PROFILE_INDEX	1	The RF analog settings corresponding to this profile are used for monitoring RX mixer input power using test chirps (static frequency, at the center of the profile's RF frequency band).

Continued on next page

Table 8.31 – continued from previous page

REPORTING_ MODE	1	<p>Value Definition</p> <p>0 Report is sent every monitoring period without threshold check</p> <p>1 Report is send only upon a failure (after checking for thresholds)</p> <p>2 Report is sent every monitoring period with threshold check</p>
TX_EN	1	<p>This field indicates if and which TX channels should be enabled while measuring RX mixer input power. Setting a bit to 1 enables the corresponding TX channel. Enabling a TX channel may help find reflection power while disabling may help find interference power.</p> <p>Bit number TX Channel</p> <p>b0 TX0</p> <p>b1 TX1</p> <p>b2 TX2</p>
RESERVED	1	0x00
THRESHOLDS	2	<p>The measured RX mixer input voltage swings during this monitoring is compared against the minimum and maximum thresholds configured in this field. The comparison result is part of the monitoring report message (Status bit is cleared if any measurement is outside this (minimum, maximum) range).</p> <p>Byte number Threshold</p> <p>0 Minimum Threshold</p> <p>1 Maximum Threshold</p> <p>Only the RX channels enabled in the static configuration APIs are monitored.</p> <p>1 LSB = 1800 mV/256, unsigned number Valid range: 0 to 255, maximum threshold \geq minimum threshold</p>
RESERVED	2	0x00000000
RESERVED	4	0x00000000

8.17 Sub block 0x01DE – RESERVED

8.18 Analog Fault injection

8.18.1 Sub block 0x01DF – AWR_ANALOG_FAULT_INJECTION_CONF_SB

This API is a fault injection API which the host sends to the AWR device. It can be used to inject faults in the analog circuits to test the corresponding monitors. After the faults are injected, the regular enabled monitors will indicate the faults in their associated reports.

NOTE1:	This API should be issued when no frames are on-going.
NOTE2:	The fault injection should be tested by injecting one fault at a time and corresponding analog monitor should be observed, other monitors might show failure depending on type of fault, it can be discarded.
NOTE3:	It is recommended to perform device reset after enabling fault injection before moving to functional mode.
NOTE4:	Some of the fault injection options are de-featured, please refer latest DFP release note for more details.
NOTE5:	Disable all runtime calibrations while Fault is injected.

Table 8.32: AWR_ANALOG_FAULT_INJECTION_CONF_SB contents

Field Name	Number of bytes	Description
SBLKID	2	Value = 0x01DF
SBLKLEN	2	Value = 24
RESERVED	1	0x00

Continued on next page

Table 8.32 – continued from previous page

RX_GAIN_DROP	1	<p>Primary Fault: RX Gain</p> <p>This field indicates which RX RF sections should have fault injected. If the fault is enabled, the RX RF gain drops significantly. The fault can be used to cause significant gain change, inter-RX gain imbalance and an uncontrolled amount of inter-RX phase imbalance.</p> <p>Bit number RX Channel</p> <p>b0 RX0</p> <p>b1 RX1</p> <p>b2 RX2</p> <p>b3 RX3</p> <p>Others RESERVED</p> <p>For each bit, 1 = inject fault, 0 = remove injected fault</p>
RX_PHASE_INV	1	<p>Primary Fault: RX Phase</p> <p>This field indicates which RX channels should have fault injected. If the fault is enabled, the RX phase gets inverted. The fault can be used to cause a controlled amount (180o) of inter-RX phase imbalance.</p> <p>Bit number RX Channel</p> <p>b0 RX0</p> <p>b1 RX1</p> <p>b2 RX2</p> <p>b3 RX3</p> <p>Others RESERVED</p> <p>For each bit, 1 = inject fault, 0 = remove injected fault</p>

Continued on next page

Table 8.32 – continued from previous page

RX_HIGH_NOISE	1	<p>Primary Fault: RX Noise</p> <p>This field indicates which RX channels should have fault injected. If the fault is enabled, the RX IFA square wave loopback paths are engaged to inject high noise at RX IFA input. The fault can be used to cause significant RX noise floor elevation.</p> <p>Bit number RX Channel</p> <p>b0 RX0</p> <p>b1 RX1</p> <p>b2 RX2</p> <p>b3 RX3</p> <p>Others RESERVED</p> <p>For each bit, 1 = inject fault, 0 = remove injected fault</p>
RX_IF_STAGES_FAULT	1	<p>Primary Fault: Cutoff frequencies of RX IFA HPF & LPF, IFA Gain.</p> <p>This field indicates which RX channels should have fault injected. If the fault is enabled, the RX IFA HPF cutoff frequency becomes very high (about 15MHz). The fault can be used to cause the measured inband IFA gain, HPF and LPF attenuations to vary from ideal expectations.</p> <p>Bit number RX Channel</p> <p>b0 RX0</p> <p>b1 RX1</p> <p>b2 RX2</p> <p>b3 RX3</p> <p>Others RESERVED</p> <p>For each bit, 1 = inject fault, 0 = remove injected fault</p> <p>NOTE: During the execution of RX_IFSTAGE_MONITOR, the RX_HIGH_NOISE faults are temporarily removed.</p>

Continued on next page

Table 8.32 – continued from previous page

RX_LO_AMP_FAULT	1	<p>Primary Fault: RX Mixer LO input swing reduction</p> <p>This field indicates which RX channels should have fault injected. If the fault is enabled, the RX mixer LO input swing is significantly reduced. The fault is primarily expected to be detected by RX_INTERNAL_ANALOG_SIGNALS_MONITOR (under PWRDET_RX category).</p> <p>Bit number RX Channel</p> <p>b0 RX0</p> <p>b1 RX1</p> <p>b2 RX2</p> <p>b3 RX3</p> <p>Others RESERVED</p> <p>For each bit, 1 = inject fault, 0 = remove injected fault</p> <p>NOTE: This option is de-featured, please refer latest release note.</p>
TX_LO_AMP_FAULT	1	<p>Primary Fault: TX PA input signal generator turning off.</p> <p>This field indicates which TX channels should have fault injected. If the fault is enabled, the amplifier generating TX power amplifier's LO input signal is turned off. The fault is primarily expected to be detected by TX<n>_INTERNAL_ANALOG_SIGNALS_MONITOR (under DCBIAS category).</p> <p>Bit number Channel</p> <p>b0 TX0 and TX1</p> <p>b1 TX2 (applicable only if available in the device)</p> <p>Others RESERVED</p> <p>For each bit, 1 = inject fault, 0 = remove injected fault</p> <p>NOTE: This option is de-featured, please refer latest release note.</p>

Continued on next page

Table 8.32 – continued from previous page

TX_GAIN_DROP	1	<p>Primary Fault: TX Gain (power)</p> <p>This field indicates which TX RF sections should have fault injected. If the fault is enabled, the TX RF gain drops significantly. The fault can be used to cause significant TX output power change, inter-TX gain imbalance and an uncontrolled amount of inter-TX phase imbalance.</p> <table border="0"> <tr> <td>Bit number</td> <td>Channel</td> </tr> <tr> <td>b0</td> <td>TX0</td> </tr> <tr> <td>b1</td> <td>TX1</td> </tr> <tr> <td>b2</td> <td>TX2</td> </tr> <tr> <td>Others</td> <td>RESERVED</td> </tr> </table> <p>For each bit, 1 = inject fault, 0 = remove injected fault</p>	Bit number	Channel	b0	TX0	b1	TX1	b2	TX2	Others	RESERVED						
Bit number	Channel																	
b0	TX0																	
b1	TX1																	
b2	TX2																	
Others	RESERVED																	
TX_PHASE_INV	1	<p>Primary Fault: TX Phase</p> <p>This field indicates if TX channels should have fault injected, along with some further programmability. If the fault is enabled, the TX BPM polarity (phase) is forced to a constant value as programmed. The fault can be used to cause a controlled amount (180 degree) of inter-TX phase imbalance as well as BPM functionality failure.</p> <table border="0"> <tr> <td>Bit number</td> <td>TX Channel</td> </tr> <tr> <td>b0</td> <td>TX_FAULT (Common for all TX channels)</td> </tr> <tr> <td>b1</td> <td>RESERVED</td> </tr> <tr> <td>b2</td> <td>RESERVED</td> </tr> <tr> <td>b3</td> <td>TX0_BPM_VALUE</td> </tr> <tr> <td>b4</td> <td>TX1_BPM_VALUE</td> </tr> <tr> <td>b5</td> <td>TX2_BPM_VALUE</td> </tr> <tr> <td>Others</td> <td>RESERVED</td> </tr> </table> <p>For each TX_n_BPM_VALUE: Applicable only if TX_FAULT is enabled. Value = 0: force TX<n> BPM polarity to 0 Value = 1: force TX<n> BPM polarity to 1.</p> <p>NOTE: The TX_n_BPM_VALUE takes effect only when TX_FAULT value is changed</p>	Bit number	TX Channel	b0	TX_FAULT (Common for all TX channels)	b1	RESERVED	b2	RESERVED	b3	TX0_BPM_VALUE	b4	TX1_BPM_VALUE	b5	TX2_BPM_VALUE	Others	RESERVED
Bit number	TX Channel																	
b0	TX_FAULT (Common for all TX channels)																	
b1	RESERVED																	
b2	RESERVED																	
b3	TX0_BPM_VALUE																	
b4	TX1_BPM_VALUE																	
b5	TX2_BPM_VALUE																	
Others	RESERVED																	

Continued on next page

Table 8.32 – continued from previous page

SYNTH_FAULT	1	<p>Primary Fault: Synthesizer Frequency This field indicates which Synthesizer faults should be injected.</p> <p>SYNTH_VCO_OPENLOOP: If the fault is enabled, the synthesizer is forced in open loop mode with the VCO control voltage forced to a constant. In order to avoid out of band emissions in this faulty state, this fault is injected just before the PLL_CONTROL_VOLTAGE_MONITOR is executed and released just after its completion.</p> <p>Note: In 1st generation devices (xWR1xxx devices) this feature is not supported.</p> <p>SYNTH_FREQ_MON_OFFSET: If the fault is enabled, the synthesizer frequency monitor's ideal frequency ramp waveform is forced to be offset from the actual ramp waveform by a constant, causing monitoring to detect failures.</p> <p>Bit number Enable Fault b0 SYNTH_VCO_OPENLOOP (Not supported in 1st gen devices) b1 SYNTH_FREQ_MON_OFFSET Others RESERVED</p> <p>For each bit, 1 = inject fault, 0 = remove injected fault</p>
SUPPLY_LDO_FAULT	1	<p>This field indicates whether some LDO output voltage faults should be injected or not.</p> <p>Bit number Enable Fault b0 SUPPLY_LDO_RX_LODIST_FAULT Others RESERVED</p> <p>SUPPLY_LDO_RX_LODIST_FAULT: if enabled, the RX LO distribution sub system's LDO output voltage is slightly changed compared to normal levels to cause INTERNAL_PMCLKLO_SIGNALS_MONITOR to detect failure (under SUPPLY category).</p> <p>For each bit, 1 = inject fault, 0 = remove injected fault</p> <p>NOTE: This fault injection is ineffective under LDO bypass condition.</p>

Continued on next page

Table 8.32 – continued from previous page

MISC_FAULT	1	<p>This field indicates whether a few miscellaneous faults should be injected or not.</p> <p>Bit number Enable Fault b0 GPADC_CLK_FREQ_FAULT Others RESERVED</p> <p>GPADC_CLK_FREQ_FAULT: if enabled, the GPADC clock frequency is slightly increased compared to normal usage to cause BSS DCC_CLOCK_FREQ_MONITOR to detect failure.</p> <p>For each bit, 1 = inject fault, 0 = remove injected fault</p>
MISC_THRESH_FAULT	1	<p>This field indicates whether faults should be forced in the threshold comparisons in the software layer of some monitors. If a fault is enabled, the logic in the min-max threshold comparisons used for failure detection is inverted, causing a fault to be reported. During these faults, no hardware fault condition is injected in the device.</p> <p>Bit number Enable Fault b0 GPADC_INTERNAL_SIGNALS_MONITOR Others RESERVED</p> <p>For each bit, 1 = inject fault, 0 = remove injected fault</p>
RESERVED	3	0x000000
RESERVED	4	0x00000000

9 Unsupported Features/APIs and Debug APIs

9.1 Unsupported Features/APIs and Debug APIs

The list of unsupported features, APIs and debug APIs are highlighted in latest DFP release note. Please refer latest DFP 1.x release note.

10 Chirp Parameters (CP) and Chirp Quality (CQ) data

10.1 Chirp Parameters data

Chirp parameter information is always updated in the CP registers DSS_REG_VBUSM__CPREG[0-3] for single chirp use case.

NOTE: Chirp Number is always reset every burst by the hardware.

		Channel 0				Channel 1				Channel 2				Channel 3											
		Byte 0	Byte 1	Byte 2	Byte 3	Byte 4	Byte 5	Byte 6	Byte 7	Byte 8	Byte 9	Byte 10	Byte 11	Byte 12	Byte 13	Byte 14	Byte 15								
Bits	0	Channel Number	Reserved	Chirp Number[7:0]	Chirp Number[11:8]	Channel Number	Reserved	Chirp Number[7:0]	Chirp Number[11:8]	Channel Number	Reserved	Chirp Number[7:0]	Chirp Number[11:8]	Channel Number	Reserved	Chirp Number[7:0]	Chirp Number[11:8]								
	1																	Profile Number	Reserved	Profile Number	Reserved	Profile Number	Reserved	Profile Number	Reserved
	2	Reserved			Reserved	Reserved			Reserved	Reserved			Reserved	Reserved			Reserved								
	3																	Reserved	Reserved	Reserved	Reserved	Reserved	Reserved	Reserved	Reserved
	4	Reserved		Reserved	Reserved	Reserved		Reserved	Reserved	Reserved		Reserved	Reserved	Reserved		Reserved	Reserved								
	5																	Reserved	Reserved	Reserved	Reserved	Reserved	Reserved	Reserved	Reserved
	6	Reserved		Reserved	Reserved	Reserved		Reserved	Reserved	Reserved		Reserved	Reserved	Reserved		Reserved	Reserved								
	7																	Reserved	Reserved	Reserved	Reserved	Reserved	Reserved	Reserved	Reserved

Figure 10.1: Chirp parameter information fields

	31	23	16	15	8	7	0
DSS_REG_VBUSM.CH0CPREG0	Byte 3	Byte 2	Byte 1	Byte 1	Byte 0	Byte 0	Byte 0
DSS_REG_VBUSM.CH0CPREG1	Byte 7	Byte 6	Byte 5	Byte 5	Byte 4	Byte 4	Byte 4
DSS_REG_VBUSM.CH0CPREG2	Byte 11	Byte 10	Byte 9	Byte 9	Byte 8	Byte 8	Byte 8
DSS_REG_VBUSM.CH0CPREG3	Byte 15	Byte 14	Byte 13	Byte 13	Byte 12	Byte 12	Byte 12

Figure 10.2: Chirp parameter information from DSS registers

For multichip use case, the CP data is available for up to 8 chirps in DSS_REG_VBUSM.CH[0-7]CPREG[0-3].

10.2 Chirp Quality data

Chirp quality information is divided into 3 parts

1. CQ0 – Wideband signal and image energy information (Reserved for future use)
2. CQ1 – RX signal and image band energy statistics
3. CQ2 – RX ADC and IF saturation information

CQ data will be available in CQ RAM which is a ping-pong memory when the CQ monitors are enabled. Currently supported CQ monitors are AWR_MONITOR_RX_SATURATION_DETECTOR_CONF_SB for CQ2 and AWR_MONITOR_SIG_IMG_MONITOR_CONF_SB for CQ1. CQ data will be refreshed every chirp by the hardware. User has to ensure that before the next chirp finishes, the current chirps' CQ data is either processed or transferred to a local memory for further processing.

NOTE: CQ0 is not supported by firmware currently, but the CQ RAM will be updated for CQ0 data. Maximum size of CQ0 data is 256 bytes. Users should ignore the CQ RAM for CQ0.

The starting location (on 128 bit boundary) of each CQ data within the CQ memory can be configured by programming DSS_REG.CQCFG1[12:4] for CQ0, DSS_REG.CQCFG1[21:13] for CQ1 and DSS_REG.CQCFG1[30:22] for CQ2.

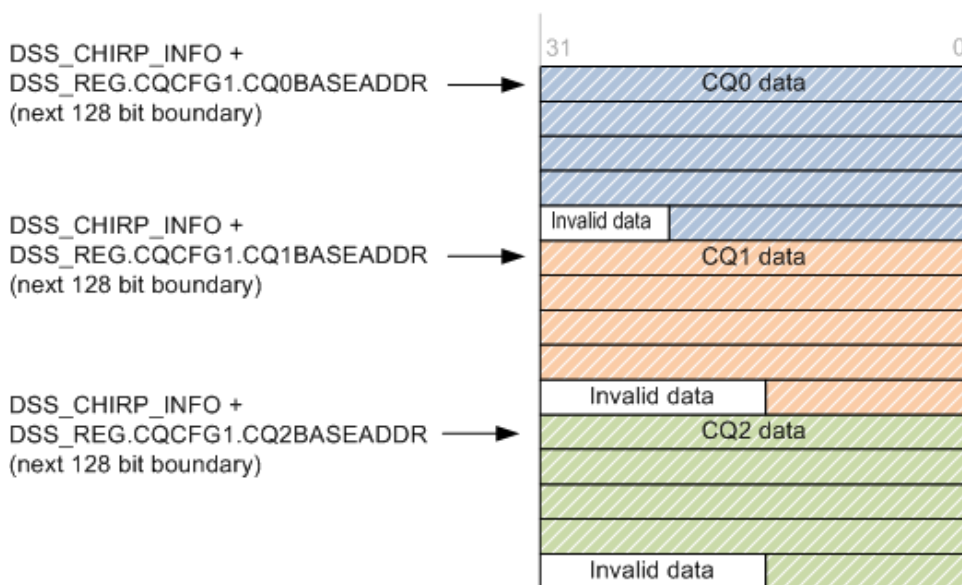

Figure 10.3: CQ data start address configuration in single chirp use case

For N-chirp use case, when user wishes to process N chirps simultaneously, then CQ0 for all N chirps will be concatenated together in memory. Similarly CQ1 and CQ2 for all N chirps will also be concatenated together.

NOTE: When CQ data is concatenated in N-chirp use case, the CQ data for new chirp starts on the next 128 bit boundary.

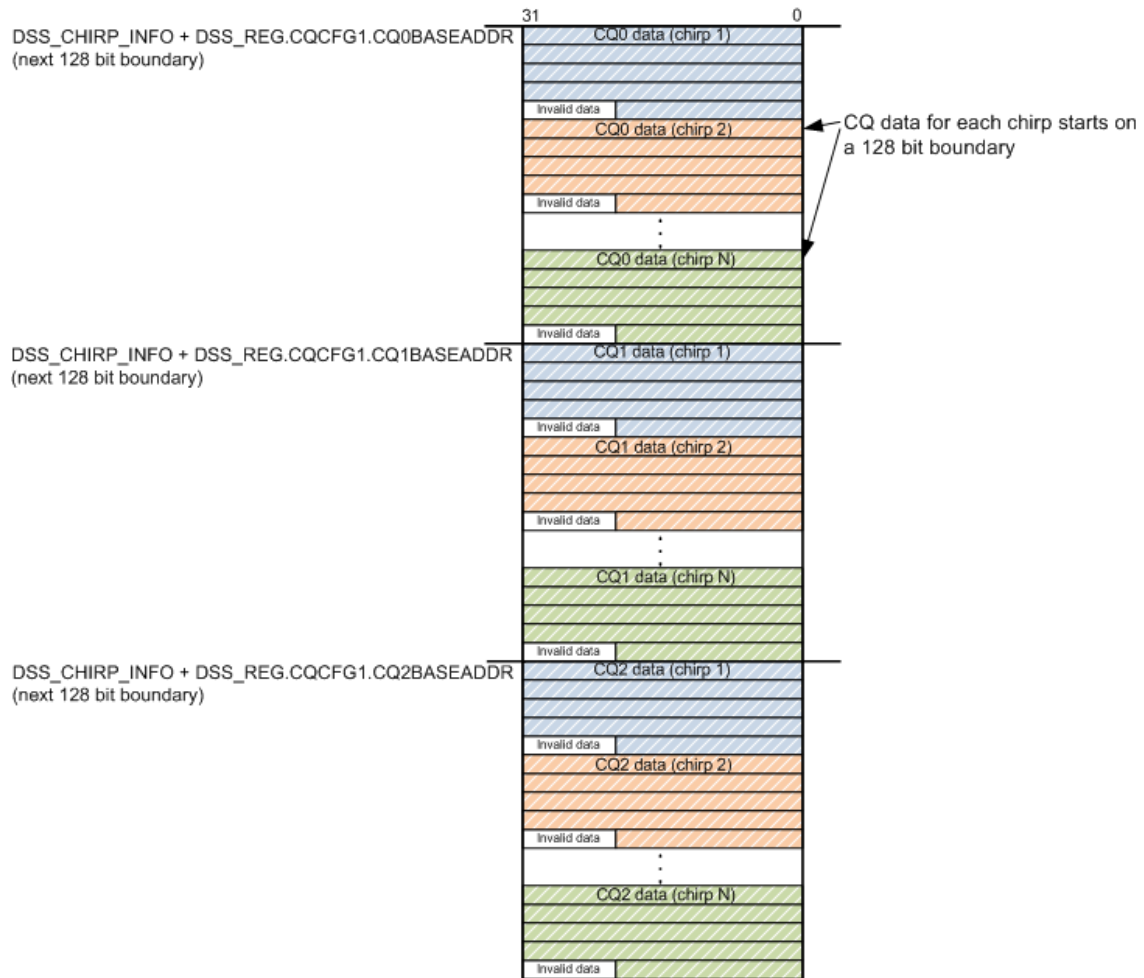

Figure 10.4: CQ data start address configuration in multi chirp use case

The CQDATAWIDTH parameter in DSS_REG.CQCFG1 defines the packing of the CQ data in the CQ memory in either 16-bit mode, 12-bit mode or in 14-bit mode.

10.2.1 CQ1

The signal band and image band are separated using a two-channel filter bank and the ADC sampling time duration is monitored in terms of primary and secondary time slices, as shown below.

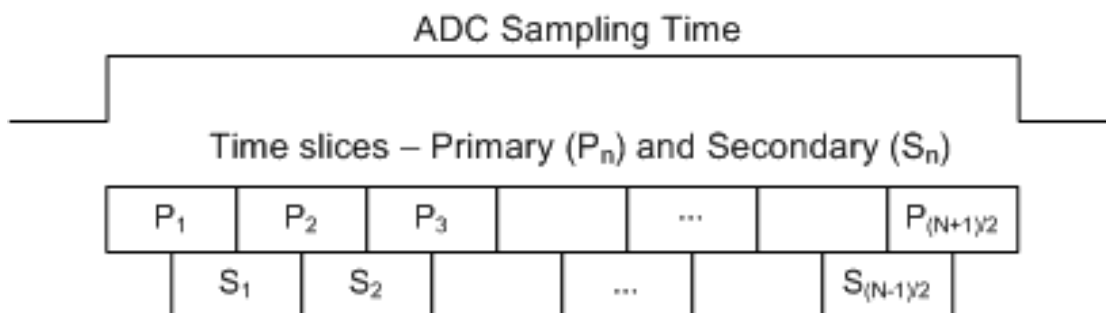

Figure 10.5: Time slices during RX signal and image band monitor and saturation monitor

For each of the two bands (signal and image), for each time slice, the input-referred average power in the slice in negative dBm is recorded as an 8-bit unsigned number, with 1 LSB = -0.5 dBm

CQ1 data is stored in memory as shown below (in 16-bit mode)

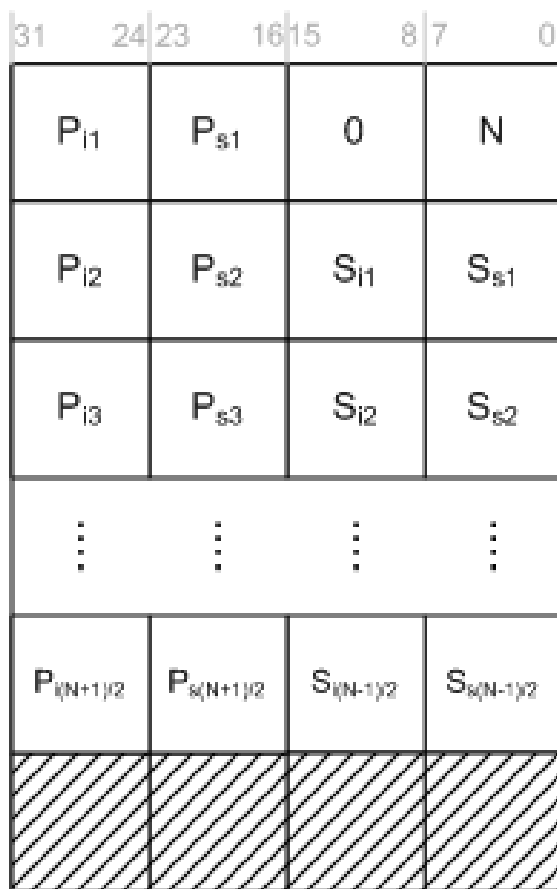

Figure 10.6: CQ1 data format in memory in 16-bit mode

N indicates the total number of primary and secondary slices which are monitored (maximum value of N is 127). P_{s,i_n} indicates the power of primary slice n for {signal, image} band and S_{s,i_n} indicates the power of secondary slice n for {signal, image} band. Each power is encoded in 8 bit unsigned number with each LSB representing -0.5 dBm.

Since maximum value of N is 127, the maximum size of CQ1 data in 16-bit mode is 256 bytes

NOTE: In real output mode, since there is no image band visibility, only the signal band statistics will be meaningful.

Similarly, in 12-bit and 14-bit modes, the CQ1 data in CQ memory will be packed as shown below. Only the relevant bits in each 16 bits of memory (either 12 bits or 14 bits) are useful and other bits are not written by hardware.

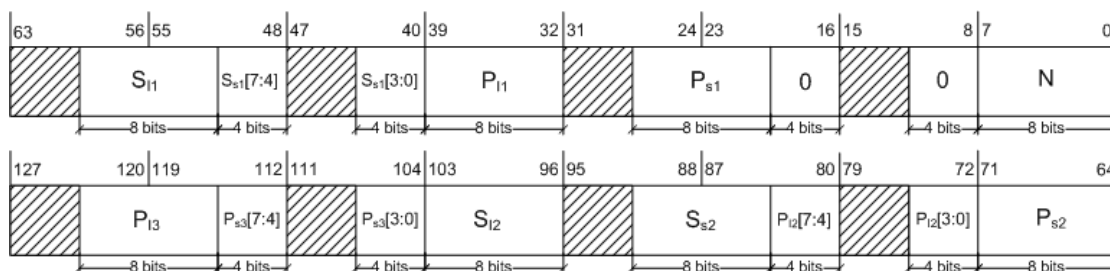

Figure 10.7: CQ1 data format in memory in 12-bit mode

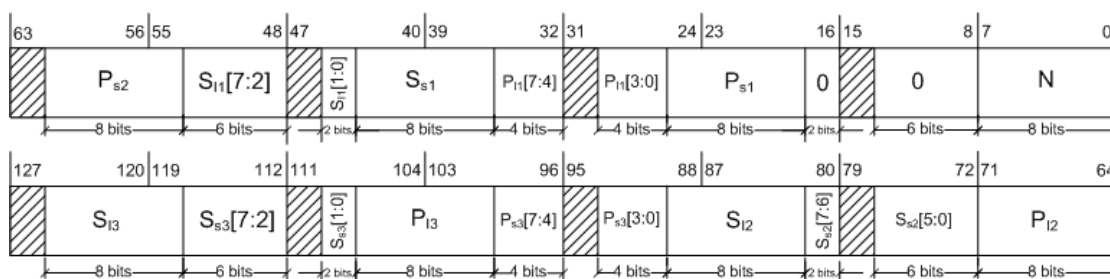

Figure 10.8: CQ1 data format in memory in 14-bit mode

10.2.2 CQ2

The analog to digital interface includes a 100 MHz bit stream indicating saturation events in the ADC/IF sections, for each channel. This one-bit indicator for each channel is monitored during the ADC sampling time duration in a time-sliced manner, as shown in Figure 10.5.

For each time slice, a saturation event count is recorded. This count is the sum of saturation event counts across all RX channels selected for monitoring, capped to a maximum count of 255 (8 bits). The saturation counts are stored in memory as shown below

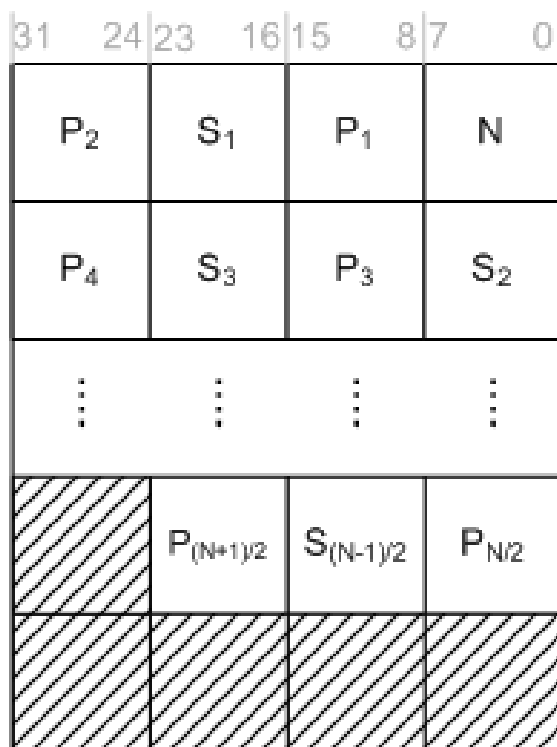

Figure 10.9: CQ2 data format in memory in 16-bit mode

N indicates the total number of primary and secondary slices which are monitored (maximum value of N is 127). P_n indicates the accumulated saturation count for all enabled RX channels in primary slice n, S_n indicates the accumulated saturation count for all enabled RX channels in secondary slice n.

Since maximum value of N is 127, the maximum size of CQ2 data in 16-bit mode is 128 bytes. Similarly, in 12-bit and 14-bit modes, the CQ2 data in CQ memory will be packed as shown below. Only the relevant bits in each 16 bits of memory (either 12 bits or 14 bits) are useful and other bits are not written by hardware.

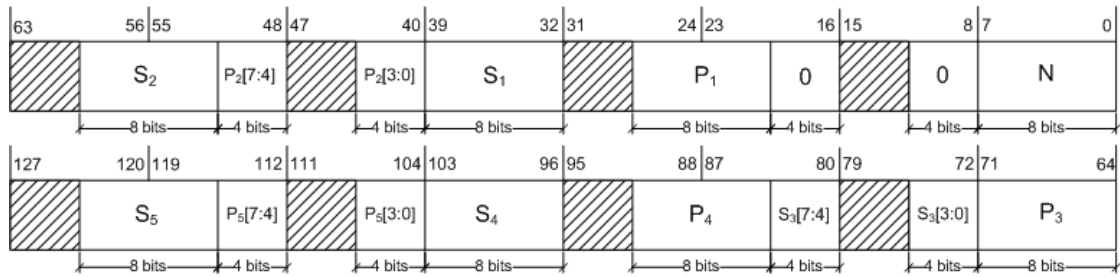

Figure 10.10: CQ2 data format in memory in 12-bit mode

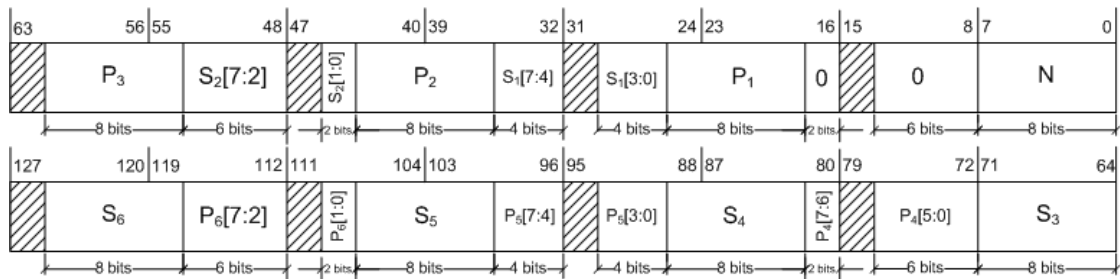

Figure 10.11: CQ2 data format in memory in 14-bit mode

11 Chirp, Burst and Frame timings

The device minimum chirp cycle time, inter-burst time, inter sub-frame/frame time requirements for 1st gen xWR1xxx and xWR6843 devices are documented in this section.

11.1 Chirp Cycle Time

Table 11.1: Minimum chirp cycle time

Use case	Min Chirp cycle time (μ s) for xWR1xxx	Min Chirp cycle time (μ s) for xWR6843	Description
Typical chirps in normal mode of operation	15	13	The normal chirps used in a burst or a frame using legacy chirp configuration API
WDT enable configuration time	10	0	Add WDT configure time to minimum chirp cycle time if it is enabled. By default WDT is disabled, it can be enabled using AWR_RF_DEVICE_CFG_SB API
Per chirp phase shifter(PS) configuration time	10	0	Add per chirp PS configure time to minimum chirp cycle time if it is enabled. By default per chirp PS is disabled, it can be enabled using AWR_RF_RADAR_MISC_CTL_SB API

11.2 Minimum Inter Burst Time

Table 11.2: Minimum inter burst time

Min inter burst time		Time (μ s) for xWR1xxx	Time (μ s) for xWR6843	Description
Typical inter burst time		100 (inter burst pwr save default enabled)	55	The minimum inter burst idle time required in normal bursts with legacy chirps configured in a advanced frame configuration API with inter burst power save disabled.
Inter burst power save time		NA	55	Add inter burst power save time to minimum inter burst time if it is enabled. By default inter-burst power save is enabled, it can be disabled using AWR_RF_DEVICE_CFG_SB API
Inter chirp power save override time (power save disable)		15	15	Add inter chirp power save override time to minimum inter burst time if chirp idle time < 10us in a burst or can be controlled using AWR_DYNAMICPOWERSAVE_CONF_SET_SB API
Calibration or Monitoring chirp time		150	145	Add calibration or Monitoring chirp time to minimum inter burst time if calibration or monitors intended to be run in inter burst idle time. The calibration and monitoring chirps can run only in inter sub-frame or inter-frame interval if this time is not allocated in inter-burst time. Add calibration or Monitoring duration to minimum inter burst or sub-frame/frame time.

11.3 Minimum Inter Sub-frame or Frame Time

Table 11.3: Minimum inter sub-frame/frame time

Min inter sub-frame/frame time	Time (μs) for xWR1xxx and xWR6843	Description
Typical inter sub-frame/frame time	300	The minimum inter sub-frame/frame idle time required in normal sub-frames with legacy chirps configured in a advanced frame configuration API or in a legacy frame config API. This time includes time required for minimum inter-burst idle time, inter burst power save, inter chirp power save override and single calibration/monitoring chirp time.
Calibration or Monitoring duration	Refer table Table 12.2 and Table 12.3	Add calibration or Monitoring duration to minimum inter sub-frame/frame time
Loop-back burst configuration time	300	Add Loop-back burst configuration time to minimum inter sub-frame time for loop back sub-frames if it is enabled in advance frame config API.
Dynamic legacy chirp configuration time (for 16 chirps)	20 for 16 chirps + 500	Add dynamic legacy chirp configuration time to minimum inter frame time if dynamic chirp/phase-shifter APIs are issued in runtime.
Dynamic profile configuration time (for 1 profile)	1200	Add dynamic profile configuration time to minimum inter frame time if dynamic profile API is issued in runtime.
Test source config time	150	Add test source configuration time to minimum inter sub-frame time if test source API is issued.

12 Calibration and monitoring durations

12.1 Boot time calibration durations

Table 12.1: Duration of boot time calibrations

Sl. No.	Calibration	Duration (μ s) for xWR1xxx	Duration (μ s) for xWR6843
1	APLL	330	330
2	Synth VCO	2500	2500
3	LO DIST	12	12
4	ADC DC	600	600
5	HPF cutoff	3500	3500
6	LPF cut off	9000	200
7	Peak detector	6000	8000
8	TX power (assumes 2 TX use-case)	6000	6000
9	RX gain	2300	1500
10	TX phase	36 000	36 000
11	RX IQMM	26 000	42 000

12.2 Run time calibration durations

Table 12.2 lists the duration of all run time calibrations. Note that the firmware performs calibrations in small chunks of 150 μ s. User has to ensure that the total idle time in one CAL_MON_TIME_UNIT is sufficient to fit the enabled calibrations.

To configure CALIB_MON_TIME_UNIT, user has to calculate the total available IDLE time in the frame and please refer Table 11.2 for the same. The duration for all the enabled calibrations should be included and following software overheads should be added to that number

Table 12.2: Duration of run time calibrations

SI. No.	Calibration	Duration (μ s) for xWR1xxx	Duration (μ s) for xWR6843
1	APLL	150	150
2	Synth VCO	350	350
3	LO DIST	30	30
4	Peak detector	500	600
5	TX power (assumes 1 TX, 1 profile CLPC)	800	800
5	TX power (assumes 1 TX, 1 profile OLPC)	30	30
6	RX gain	30	30
7	Application of calibration to hardware (This needs to be included always)	100	100

12.3 Monitoring duration

Table [12.3](#) lists the duration of all analog monitors and Table [12.4](#) lists the duration of all digital monitors

Table 12.3: Duration of analog monitors

Sl. No.	Monitors	Duration (μ s)
1	RX gain phase (assumes 1 RF frequency)	1250
2	RX noise figure (assumes 1 RF frequency)	250
3	RX IF stage (assumes 1 RF frequency)	1000
4	TX power (assumes 1 TX, 1 RF frequency)	200
5	TX ballbreak (assumes 1 TX)	250
6	TX gain phase mismatch (assumes 1 TX, 1 RF frequency)	400
7	TX BPM (assumes 1 TX)	575
8	Synthesizer frequency	0
9	External analog signals (all 6 GPADC channels enabled)	150
10	TX Internal analog signals (assumes 1 TX)	200
	TX Phase shifter DAC monitor (assumes 1 TX), (applicable only for xWR1843/6843 devices)	2200
11	RX internal analog signals	1700
12	PMCLKLO internal analog signals	400
13	GPADC internal signals	50
14	PLL control voltage	250
15	Dual clock comparator (assumes 6 clock comparators)	110
16	RX saturation detector	0
17	RX signal and image band monitor	0
18	RX mixer input power	600
19	Temperature monitor	200

Table 12.4: Duration of digital monitors

Sl. No.	Monitors	Duration (μ s)
1	Periodic configuration register readback	70
2	DFE LBIST monitoring	1000
3	Frame timing monitoring	10

12.4 Software overheads

When the calibrations or monitorings are enabled, the software needs certain time for reading the temperature sensors, reading the DFE statistics, preparing the calibration or monitoring reports and to clear the watchdog (WDT). All these time durations should also be accounted when computing the CALIB_MON_TIME_UNIT. The details of the software overheads are given in the Table 12.5

Table 12.5: Software overheads every FTTI that should be accounted to program CALIB_MON_TIME_UNIT and CALIBRATION_PERIODICITY

Sl. No.	Software overhead	Duration (μ s)
1	Periodic monitoring of stack usage	20
2	Minimum monitoring duration (report formation, digital energy monitor at the end of FTTI, temperature read every FTTI)	1000
3	Minimum calibration duration (report formation, temperature read every CAL_MON_TIME_UNIT)+	500
4	Idle time needed per FTTI for windowed watchdog (WDT)	$\text{Frame period} \times \text{CALIB_MON_TIME_UNIT}/8$ i.e. $\sim 12.5\%$ of $\text{Frame period} \times \text{CALIB_MON_TIME_UNIT}$ is reserved for watchdog clearing time

12.4.1 Note on idle time for clearing the watchdog (WDT)

The clearing window of the watchdog is 12.5% of total FTTI as shown in the figure below. One FTTI can have multiple frames in legacy frame configuration or in advanced frame configuration - each frame can have multiple sub-frames and each sub-frame can have multiple bursts. The required idle time for clearing watchdog is absolute 12.5% of the overall FTTI interval, this 12.5% clearing window can have multiple frames or subframes or bursts. The granularity of the required watchdog idle time calculation is limited to sub-frame period.

Example

A user has enabled advanced frame configuration where each frame consists of 3 sub-frames and each sub-frame is of 5 ms duration. FTTI is configured as 25 frames. Each sub-frame contains 100 chirps, each chirp consisting of 4 μ s idle time and 21 μ s ramp time. i.e. duty cycle is 50%. The watchdog clearing window and time for calibration and monitoring is calculated as follows

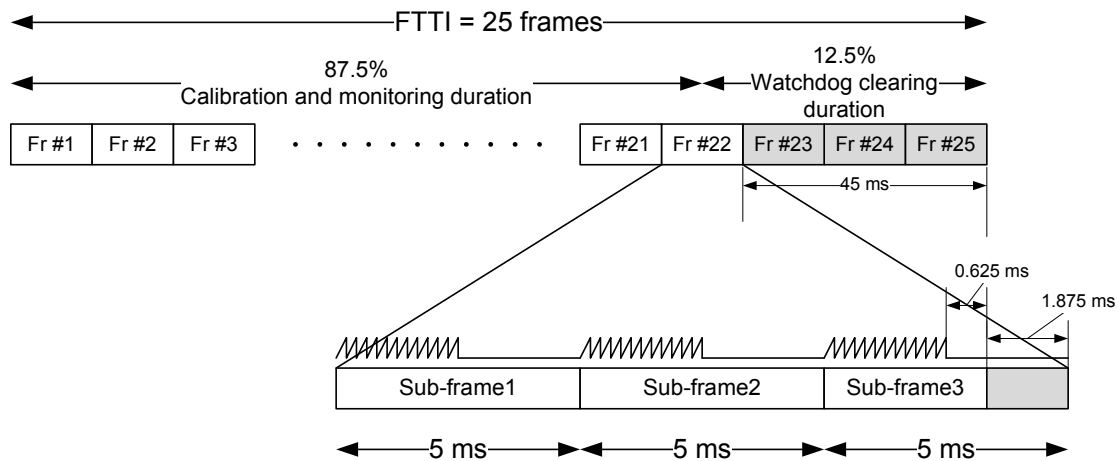

Figure 12.1: Watchdog idle time calculation

Frame duty cycle	=	50	%
Idle time per frame (50% of 15 ms)	=	7.5	ms
FTTI (15 ms × 25 frames)	=	375	ms
Available idle time per FTTI (50% of 375 ms)	=	187.5	ms
Ideal watchdog clearing window (12.5% of 375 ms)	=	46.875	ms
The calculated watchdog clearing window in firmware is as follows			
Duration of complete frames which can be fit in watchdog clearing window ($\lceil 46.875/15 \rceil \times 15$)	=	45	ms
Fractional watchdog clearing time (which will be fit in the sub-frame idle time) ($46.875 - (15 \times 3)$)	=	1.875	ms
Time available for calibration/monitoring per FTTI (21 frames × 7.5 ms) + (2 sub-frames × 2.5 ms) + 0.625 ms	=	163.125	ms

The following examples show how the user can budget for calibration and monitoring time and configure the FTTI correctly.

Example 1

A user has enabled 2 TX, uses only 1 profile, frame configuration consists of 64 chirps, each chirp is of duration is 66 μ s (56 μ s ramp time and 10 μ s chirp idle time) and frame periodicity is 10 ms. User has enabled all run time calibrations. None of the analog monitoring is enabled.

Frame duty cycle	=	42.24%
Idle time per frame (57.76% of 10 ms)	=	5.776 ms
Idle time available for calibration/monitoring per frame (100 μ s is for frame preparation)	=	5.676 ms
Time needed for all run time calibrations.....	=	2760 μ s
150 + 300 + 30 + 500 + (800 \times 2) + 30 + 150	=	2770 μ s
Minimum time for software overheads.....	=	2770 μ s
20 + 1000 + 500 + (10000 \times 1/8)	=	5530 μ s
Total time needed per frame for calibration 2760 μ s + 2770 μ s	=	5530 μ s

Total time needed per frame for calibration is 5.530 μ s which is less than the frame idle time (5.676 ms) and hence this configuration will be honored by the MMIC device.

User can set CALIB_MON_TIME_UNIT to 1 and CALIBRATION_PERIODICITY as 100. With this setting calibrations are triggered once every 100 frames (i.e. once every 1 s)

Example 2

Consider another example where the frame configuration remains the same as in example 1, but frame periodicity is reduced to 8 ms.

Frame duty cycle	= 52.80%
Idle time per frame (47.20% of 8 ms)	= 3.776 ms
Idle time available for calibration/monitoring per frame (100 μ s is for frame preparation)	} = 3.676 ms
Time needed for all run time calibrations.....	} = 2760 μ s
150 + 300 + 30 + 500 + (800 \times 2) + 30 + 150	
Minimum time for software overheads.....	} = 2520 μ s
20 + 1000 + 500 + (8000 \times 1/8)	
Total time needed per frame for calibration	} = 5280 μ s
2760 μ s + 2520 μ s	

Total time needed per frame for calibration is 5.280 μ s which is more than the frame idle time (3.676 ms) and hence this configuration will **not** be honored by the MMIC device.

User can set CALIB_MON_TIME_UNIT to 2 and CALIBRATION_PERIODICITY as 63. With this setting calibrations are triggered once every 126 frames (i.e. once every 1.008 s)

Example 3

A user has enabled 2 TX, uses 2 profiles, frame configuration consists of 32 chirps, each chirp is of duration is 90 μ s (80 μ s ramp time and 10 μ s chirp idle time) and frame periodicity is 6 ms. User has enabled all run time calibrations. None of the analog monitoring is enabled.

Frame duty cycle	= 48.00%
Idle time per frame (52.00% of 6 ms)	= 3.120 ms
Idle time available for calibration/monitoring per frame (100 μ s is for frame preparation)	= 3.020 ms
Time needed for all run time calibrations.....	} = 4360 μ s
150 + 300 + 30 + 500 + (800 \times 2 \times 2) + 30 + 150	
Minimum time for software overheads.....	} = 2270 μ s
20 + 1000 + 500 + (6000 \times 1/8)	
Total time needed per frame for calibration	} = 6630 μ s
4360 μ s + 2270 μ s	

Total time needed per frame for calibration is 6.630 μ s which is more than the frame idle time (3.020 ms) and hence this configuration will **not** be honored by the MMIC device.

User can set CALIB_MON_TIME_UNIT to 3 and CALIBRATION_PERIODICITY as 56. With this setting, minimum required time is 8.13 ms and available idle time for calibration/monitoring is 9.06 ms and calibrations are triggered once every 168 frames (i.e. once every 1.008 s)

Example 4

A user has enabled 2 TX, uses 2 profiles, frame configuration consists of 32 chirps, each chirp is of duration is 90 μ s (80 μ s ramp time and 10 μ s chirp idle time) and frame periodicity is 6 ms. User has enabled all run time calibrations. Analog monitorings which are enabled are (a) TX output power monitor for TX0 and TX1 (b) TX BPM monitor for TX0 and TX1 (c) RX gain phase monitor and (d) RX noise figure monitor. Each of the monitors are configured to be run for 1 profile and 3 RF frequencies (low, mid and high) as defined by the profile.

Frame duty cycle	= 48.00%
Idle time per frame (52.00% of 6 ms)	= 3.120 ms
Idle time available for calibration/monitoring per frame (100 μ s is for frame preparation)	= 3.020 ms
Time needed for all run time calibrations.....	} = 4360 μ s
150 + 300 + 30 + 500 + (800 \times 2 \times 2) + 30 + 150	
Time needed for all monitoring.....	} = 6850 μ s
(1250 \times 3) + (250 \times 3) + (200 \times 3 \times 2) + (575 \times 2)	
Minimum time for software overheads.....	} = 2270 μ s
20 + 1000 + 500 + (6000 \times 1/8)	
Total time needed per frame for calibration and monitoring	} = 13480 μ s
4360 μ s + 6850 μ s + 2270 μ s	

Total time needed per frame for calibration is 13.480 μ s which is more than the frame idle time (3.020 ms) and hence this configuration will **not** be honored by the MMIC device.

User can set CALIB_MON_TIME_UNIT to 6 and CALIBRATION_PERIODICITY as 28. With this setting, minimum required time for calibration and monitoring is 16.48 ms and available idle time for calibration/monitoring is 18.72 ms. Monitoring is triggered once in 6 frames and calibration is triggered once in 168 frames (i.e. once every 1.008 s)

12.5 Sample Application

For sample application please refer DFP (device firmware package) user guide document.

IMPORTANT NOTICE

Texas Instruments Incorporated ("TI") technical, application or other design advice, services or information, including, but not limited to, reference designs and materials relating to evaluation modules, (collectively, "TI Resources") are intended to assist designers who are developing applications that incorporate TI products; by downloading, accessing or using any particular TI Resource in any way, you (individually or, if you are acting on behalf of a company, your company) agree to use it solely for this purpose and subject to the terms of this Notice.

TI's provision of TI Resources does not expand or otherwise alter TI's applicable published warranties or warranty disclaimers for TI products, and no additional obligations or liabilities arise from TI providing such TI Resources. TI reserves the right to make corrections, enhancements, improvements and other changes to its TI Resources.

You understand and agree that you remain responsible for using your independent analysis, evaluation and judgment in designing your applications and that you have full and exclusive responsibility to assure the safety of your applications and compliance of your applications (and of all TI products used in or for your applications) with all applicable regulations, laws and other applicable requirements. You represent that, with respect to your applications, you have all the necessary expertise to create and implement safeguards that (1) anticipate dangerous consequences of failures, (2) monitor failures and their consequences, and (3) lessen the likelihood of failures that might cause harm and take appropriate actions. You agree that prior to using or distributing any applications that include TI products, you will thoroughly test such applications and the functionality of such TI products as used in such applications. TI has not conducted any testing other than that specifically described in the published documentation for a particular TI Resource.

You are authorized to use, copy and modify any individual TI Resource only in connection with the development of applications that include the TI product(s) identified in such TI Resource. NO OTHER LICENSE, EXPRESS OR IMPLIED, BY ESTOPPEL OR OTHERWISE TO ANY OTHER TI INTELLECTUAL PROPERTY RIGHT, AND NO LICENSE TO ANY TECHNOLOGY OR INTELLECTUAL PROPERTY RIGHT OF TI OR ANY THIRD PARTY IS GRANTED HEREIN, including but not limited to any patent right, copyright, mask work right, or other intellectual property right relating to any combination, machine, or process in which TI products or services are used. Information regarding or referencing third-party products or services does not constitute a license to use such products or services, or a warranty or endorsement thereof. Use of TI Resources may require a license from a third party under the patents or other intellectual property of the third party, or a license from TI under the patents or other intellectual property of TI.

TI RESOURCES ARE PROVIDED "AS IS" AND WITH ALL FAULTS. TI DISCLAIMS ALL OTHER WARRANTIES OR REPRESENTATIONS, EXPRESS OR IMPLIED, REGARDING TI RESOURCES OR USE THEREOF, INCLUDING BUT NOT LIMITED TO ACCURACY OR COMPLETENESS, TITLE, ANY EPIDEMIC FAILURE WARRANTY AND ANY IMPLIED WARRANTIES OF MERCHANTABILITY, FITNESS FOR A PARTICULAR PURPOSE, AND NON-INFRINGEMENT OF ANY THIRD PARTY INTELLECTUAL PROPERTY RIGHTS.

TI SHALL NOT BE LIABLE FOR AND SHALL NOT DEFEND OR INDEMNIFY YOU AGAINST ANY CLAIM, INCLUDING BUT NOT LIMITED TO ANY INFRINGEMENT CLAIM THAT RELATES TO OR IS BASED ON ANY COMBINATION OF PRODUCTS EVEN IF DESCRIBED IN TI RESOURCES OR OTHERWISE. IN NO EVENT SHALL TI BE LIABLE FOR ANY ACTUAL, DIRECT, SPECIAL, COLLATERAL, INDIRECT, PUNITIVE, INCIDENTAL, CONSEQUENTIAL OR EXEMPLARY DAMAGES IN CONNECTION WITH OR ARISING OUT OF TI RESOURCES OR USE THEREOF, AND REGARDLESS OF WHETHER TI HAS BEEN ADVISED OF THE POSSIBILITY OF SUCH DAMAGES.

You agree to fully indemnify TI and its representatives against any damages, costs, losses, and/or liabilities arising out of your noncompliance with the terms and provisions of this Notice.

This Notice applies to TI Resources. Additional terms apply to the use and purchase of certain types of materials, TI products and services. These include; without limitation, TI's standard terms for semiconductor products (<http://www.ti.com/sc/docs/stdterms.htm>), evaluation modules, and samples (<http://www.ti.com/sc/docs/sampterm.htm>).

Mailing Address: Texas Instruments, Post Office Box 655303, Dallas, Texas 75265
Copyright © 2020, Texas Instruments Incorporated