

5V DC/DC

5A

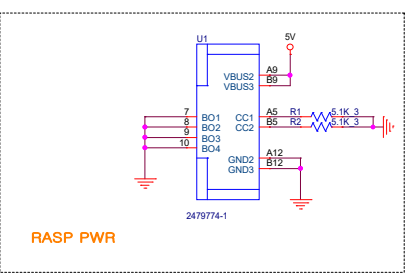

RASP PWR

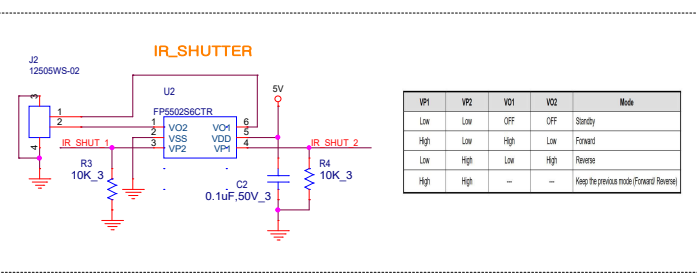

VP1	VP2	V01	V02	Mode
Low	Low	OFF	OFF	Standby
High	Low	High	Low	Forward
Low	High	Low	High	Reverse
High	High	-	-	Keep the previous mode (Forward/Reverse)

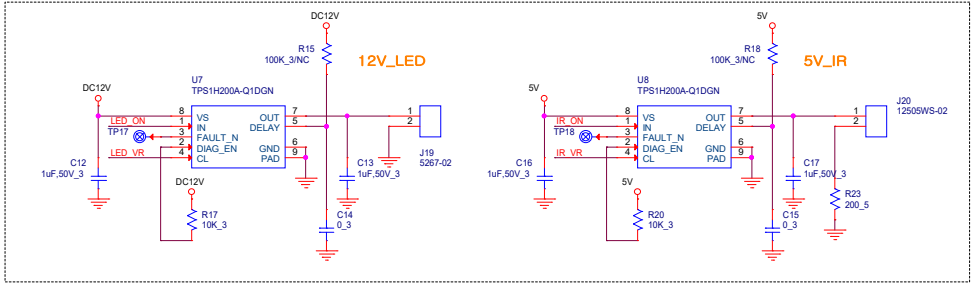
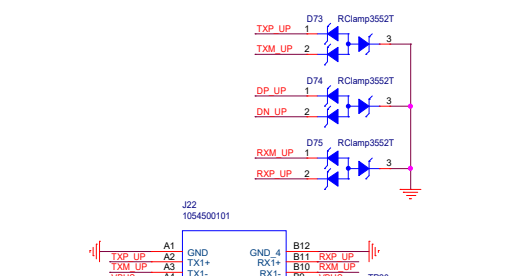

12V_LED

5V_IR

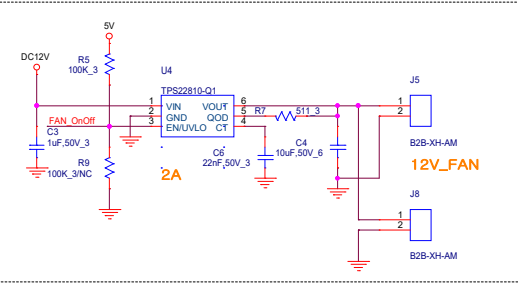

2A

12V_FAN

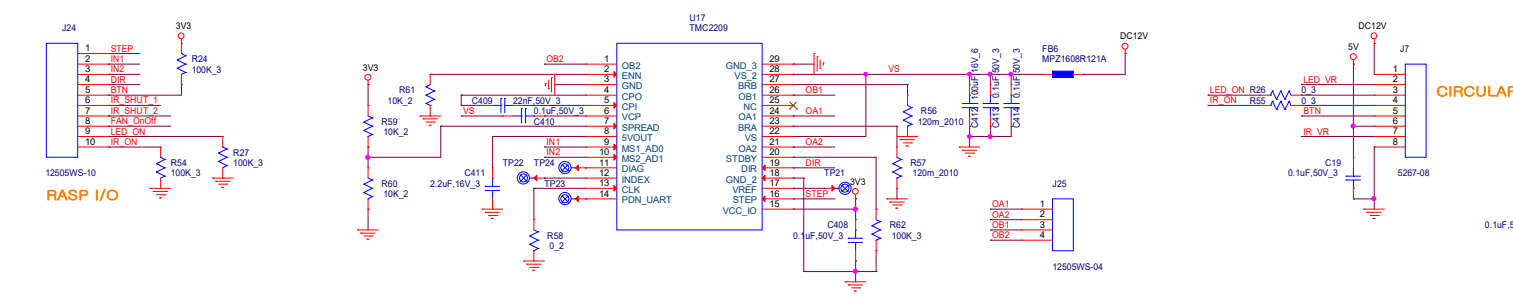
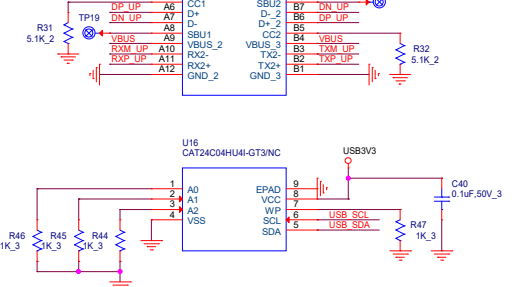

RASP I/O

CIRCULAR

