

VRF18_PMU(1.8V) 450mA

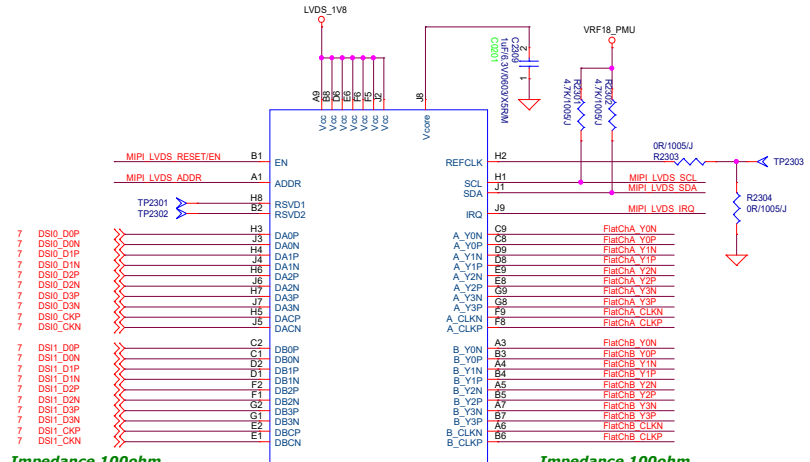

Impedance 100ohm

Impedance 100ohm

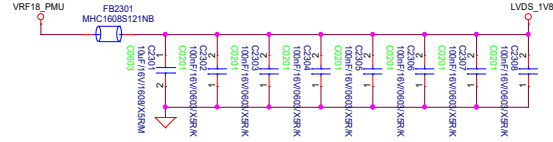
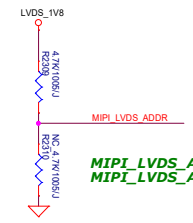
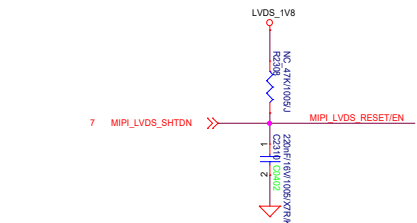

MIPI LVDS_ADDR = 1, Slave Addr = 0x2D
MIPI LVDS_ADDR = 0, Slave Addr = 0x2C

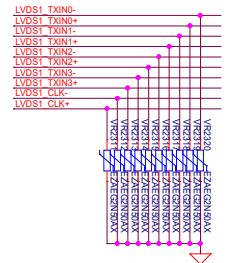
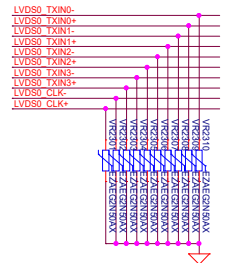
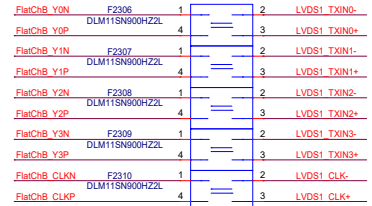
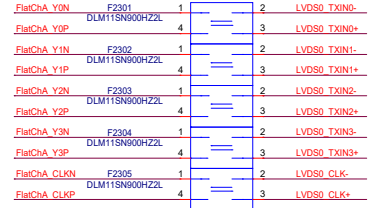

HDMI TYPE A
LVDS_0 Output & Touch UART

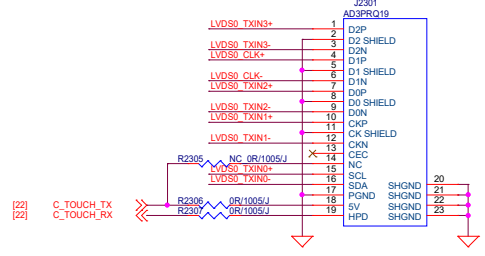

HDMI TYPE A
LVDS_1 Output

