

6

5

4

3

2

1

REVISION RECORD			
LTR	ECO NO.	APPROVED	DATE

D

D

C

C

B

B

A

A

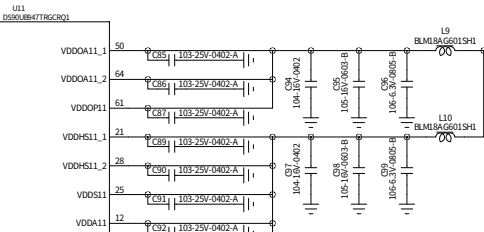
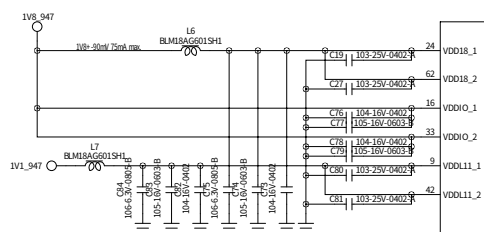

HSD-to Cluster-Blue

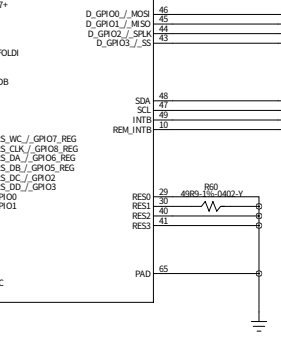
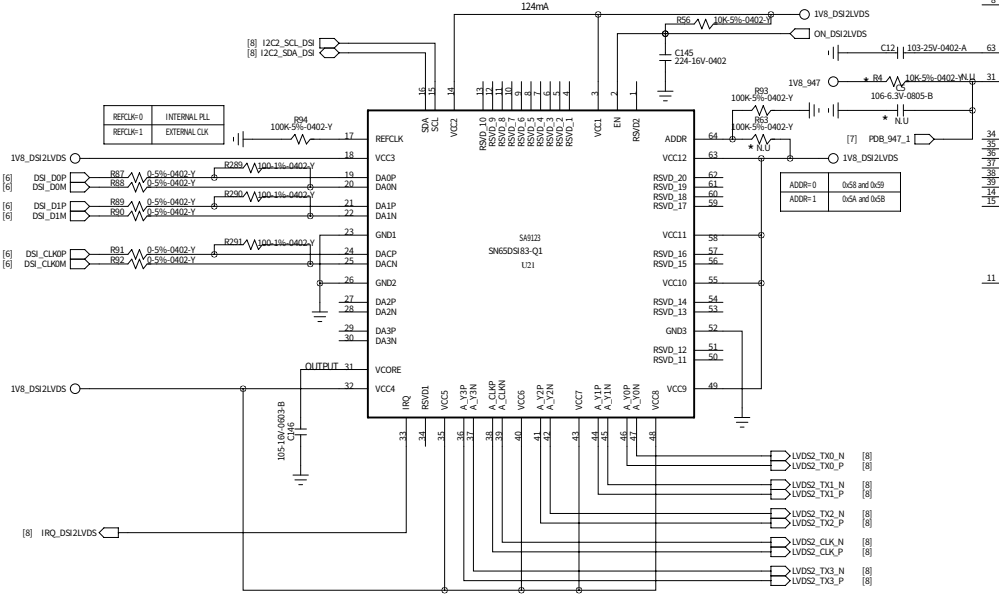
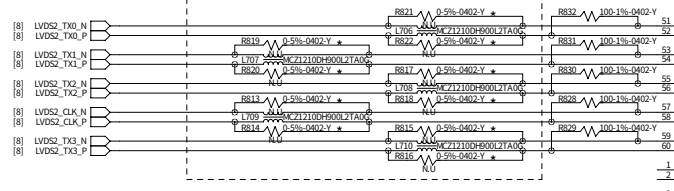
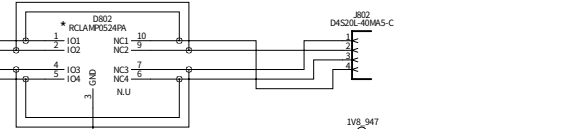

I2C Address: 0x18(W) / 0x19(R)

940 I2C Address: 0x58(W) / 0x59(R)

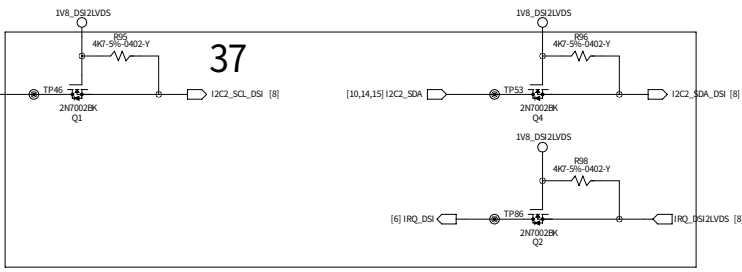

N.U: 16

COMPANY:		PATEO		
TITLE:		C3004H		
DRAWN:	ZHANG YU	DATED:	2014-12-01	REV:
CHECKED:	<Checked By>	DATED:	<Checked Date>	CODE:
QUALITY CONTROL:	<QC By>	DATED:	<QC Date>	SIZE:
RELEASED:	<Released By>	DATED:	<Release Date>	DRAWING NO.:
SCALE:		<Scale>		REV:
SHEET: 08				17

12C Address: 0x18(W) / 0x19(R)
 940 I2C Address: 0x58(W) / 0x59(R)