

Use only Tx_AMI of DS280 AMI

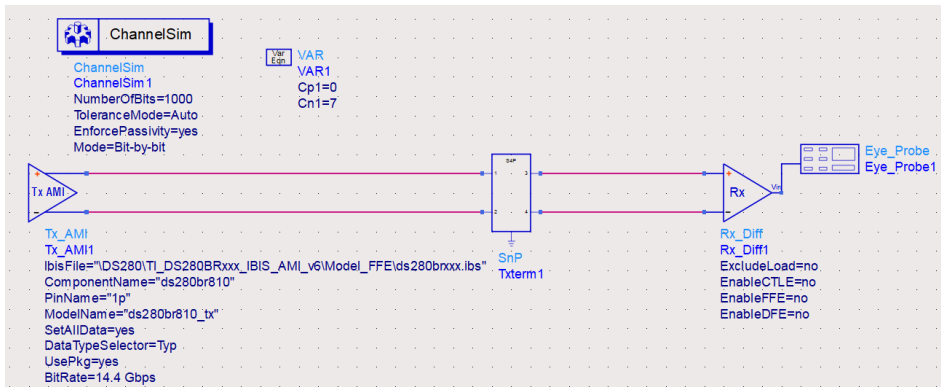

Add both Cp1 and Cn1

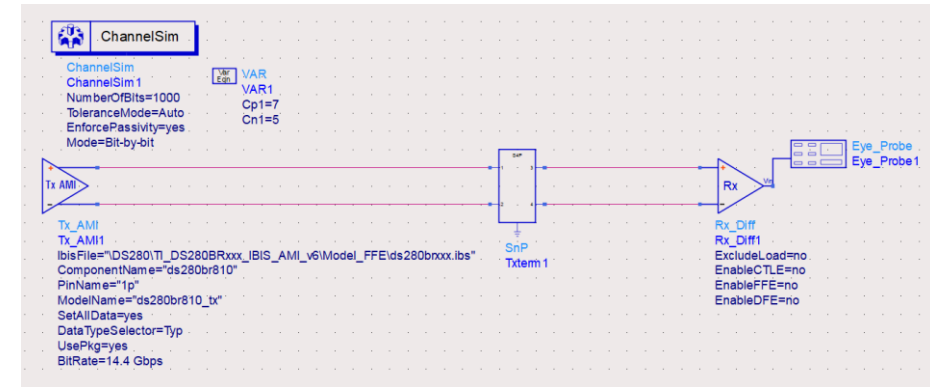
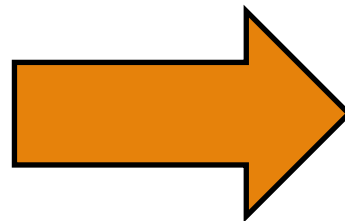

Cp1=7, Cn1=0, C0=15

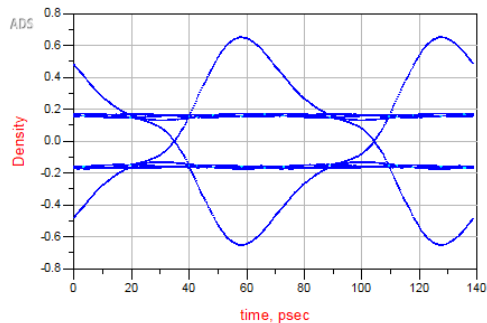

Cp1=0, Cn1=7, C0=15

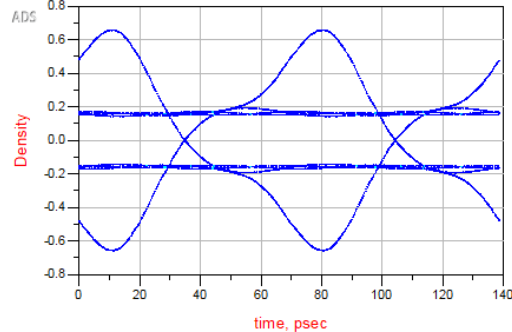

Cp1=7, Cn1=5, C0=15

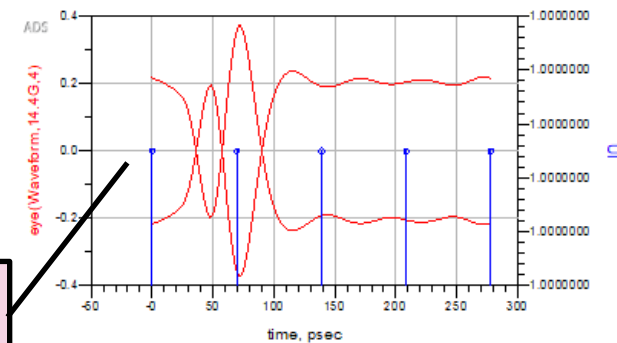
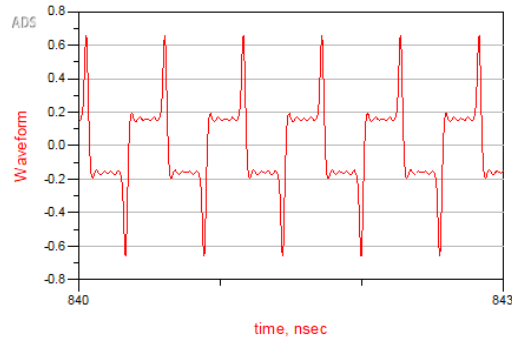
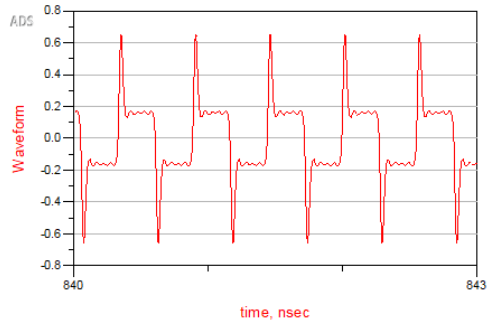
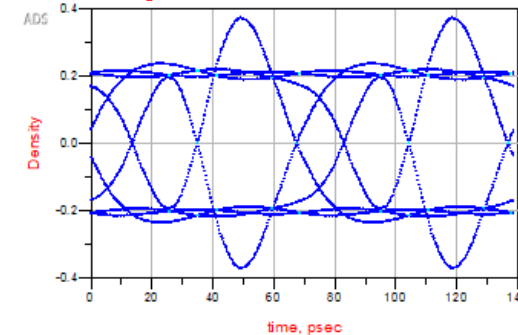

Generated strange waveform

1/14.4G/1p
69.444

Eqn UI=vs([1,1,1,1],[0,1,2,3,4]/14.4G,"time")