

CPCI J1

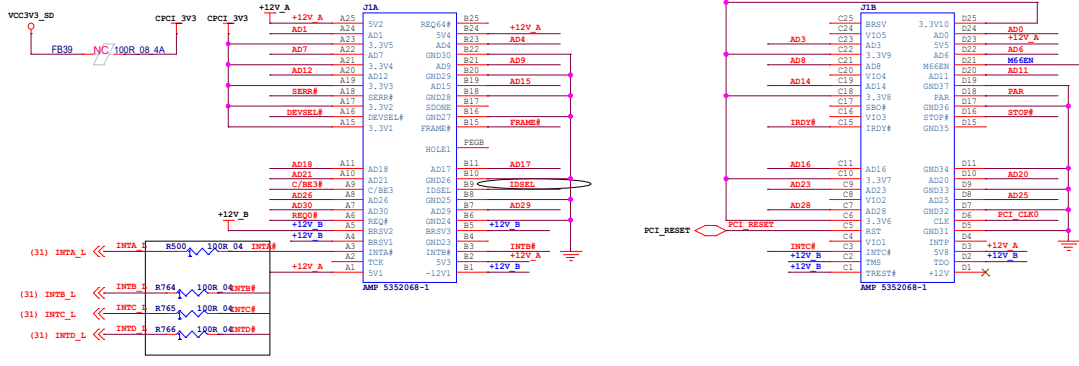

电阻换成100R\_0 4 0 2

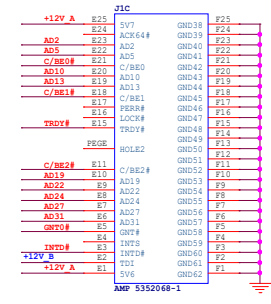

PCIE TO PCI BRIDGE

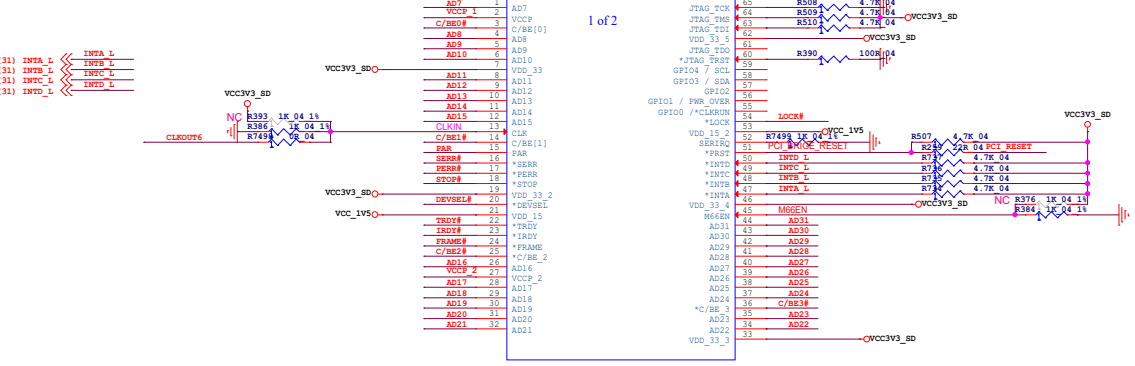

采用内部时钟源

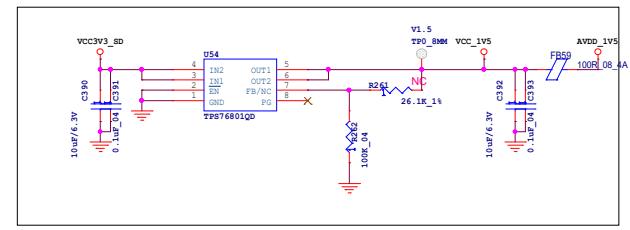
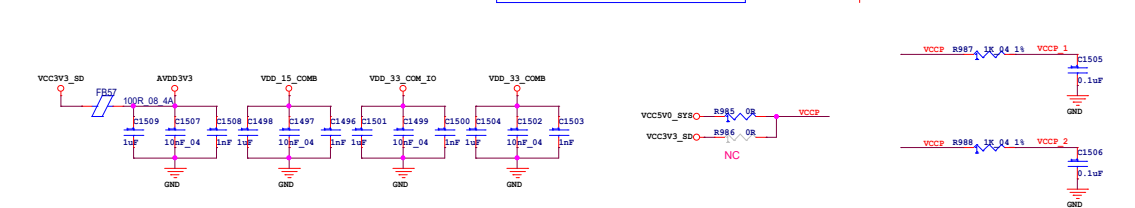
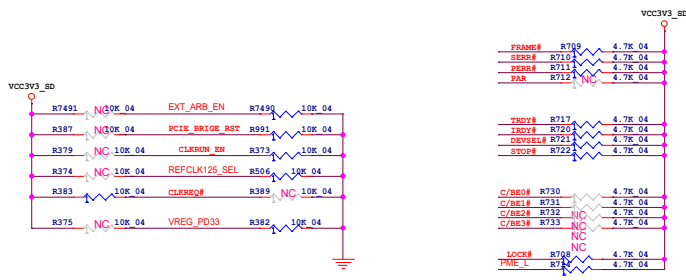
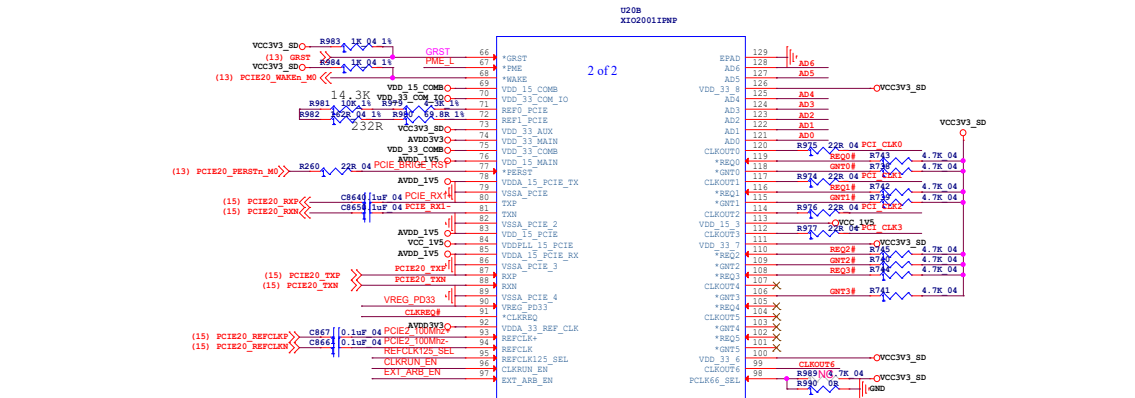
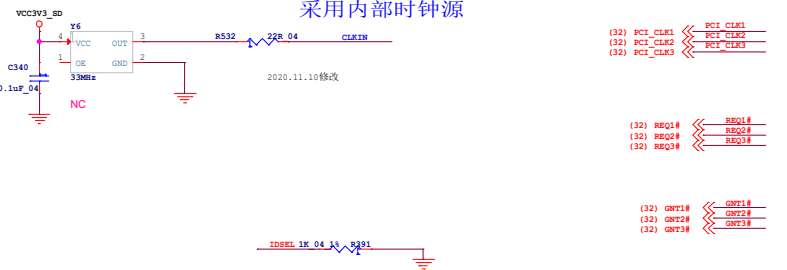

Title	<Title>	Rev	<RevCode>
Size	Document Number		
C	<Doc>		
Date	Friday, March 27, 2026	Sheet	31 of 37