

TP interface

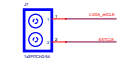

LCD interface

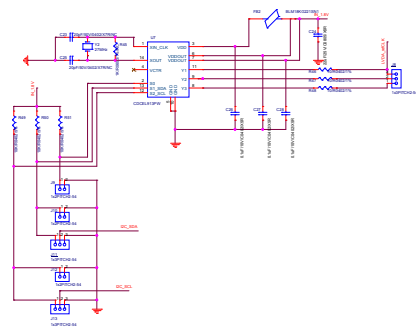
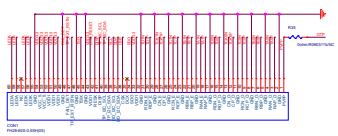

VCC3.3 备电源

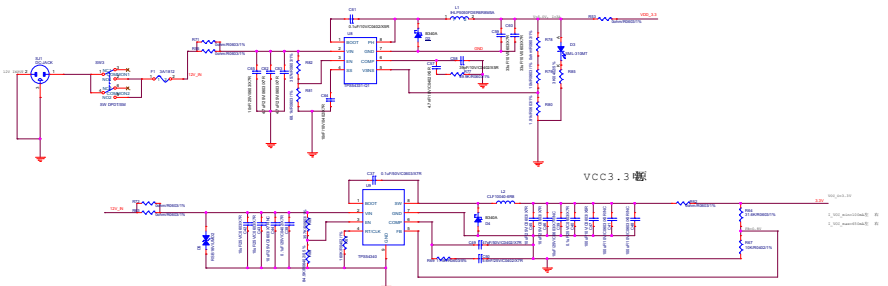

VCC3.3 源

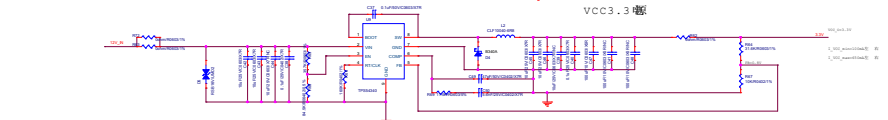

Layout 建议 3: VCC 的布线节点, 电路尽量靠近 microcontroller 输入端。

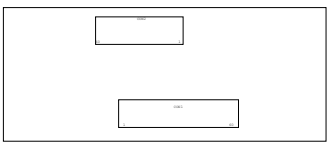
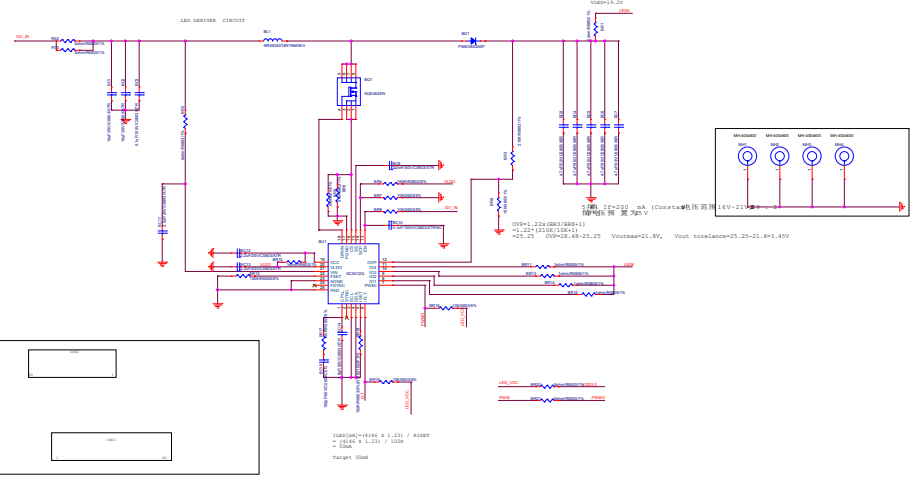

180000*1154 x 1.20 / A320
 18142 x 1.20 / 100
 Target Size