

SPI To CAN

TCAN4550 VCC3V3 PWR

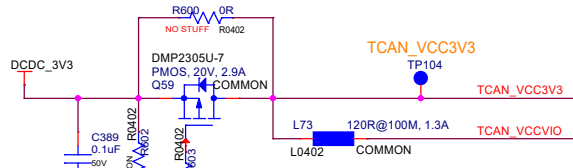

TCAN_VCC3V3供电由核心板控制

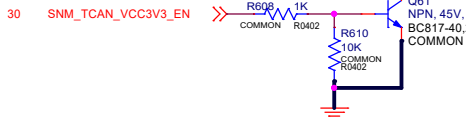

TCAN4550 KL30 PWR

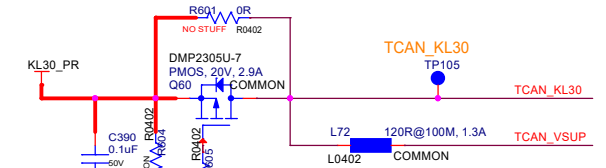

TCAN_KL30供电由核心板控制

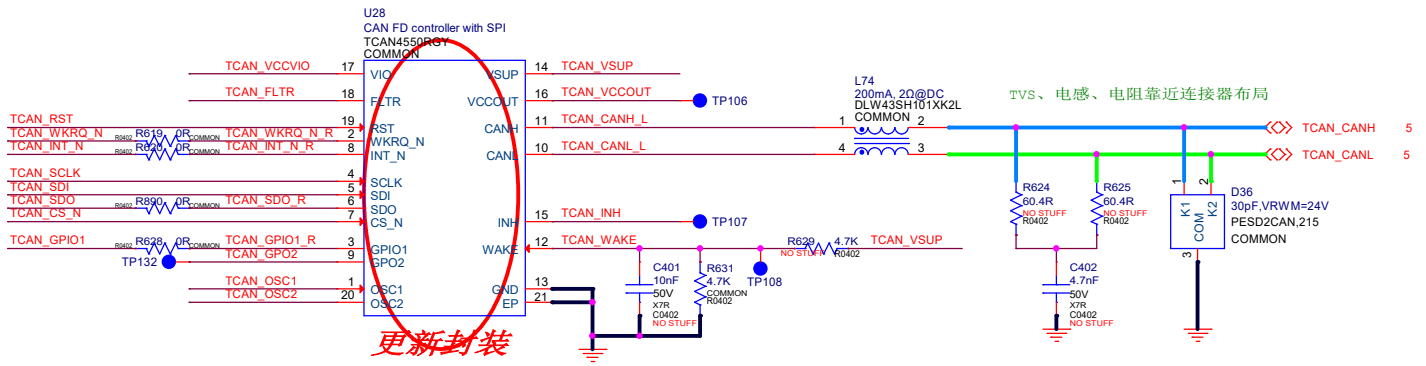
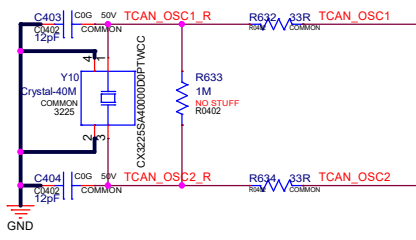
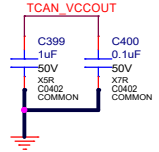
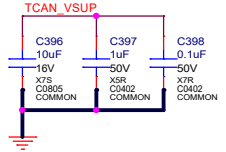
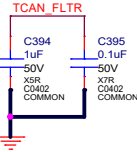
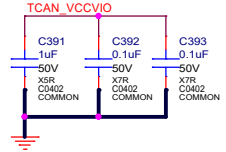
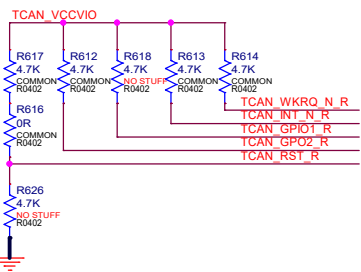

TVS、电感、电阻靠近连接器布局

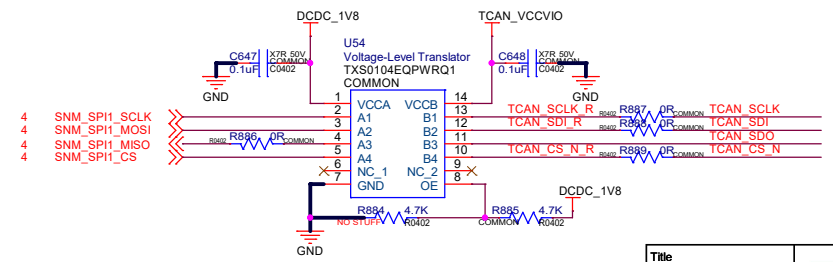
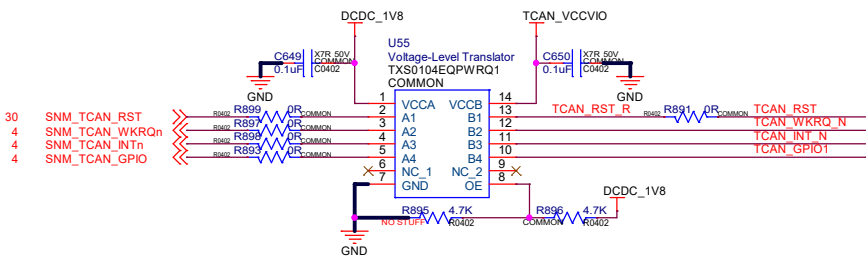

Title		IHU-Mother_Board	
Size		Document Number	Rev
Custom		20230512	A0
Date:	Monday, May 15, 2023	Sheet	26 of 30

