

HUB

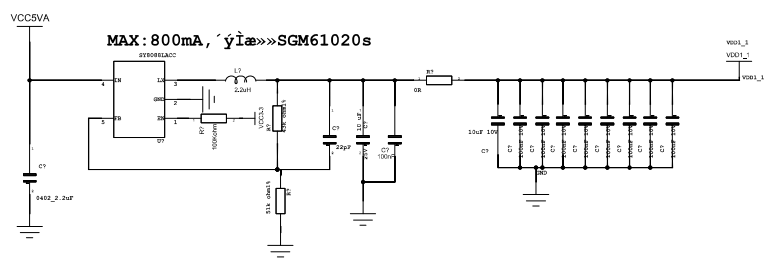

$V_{OUT} = 0.6 \times \frac{1 + 43K}{51K} \approx 1.105V$

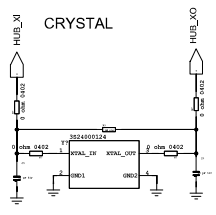
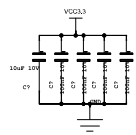
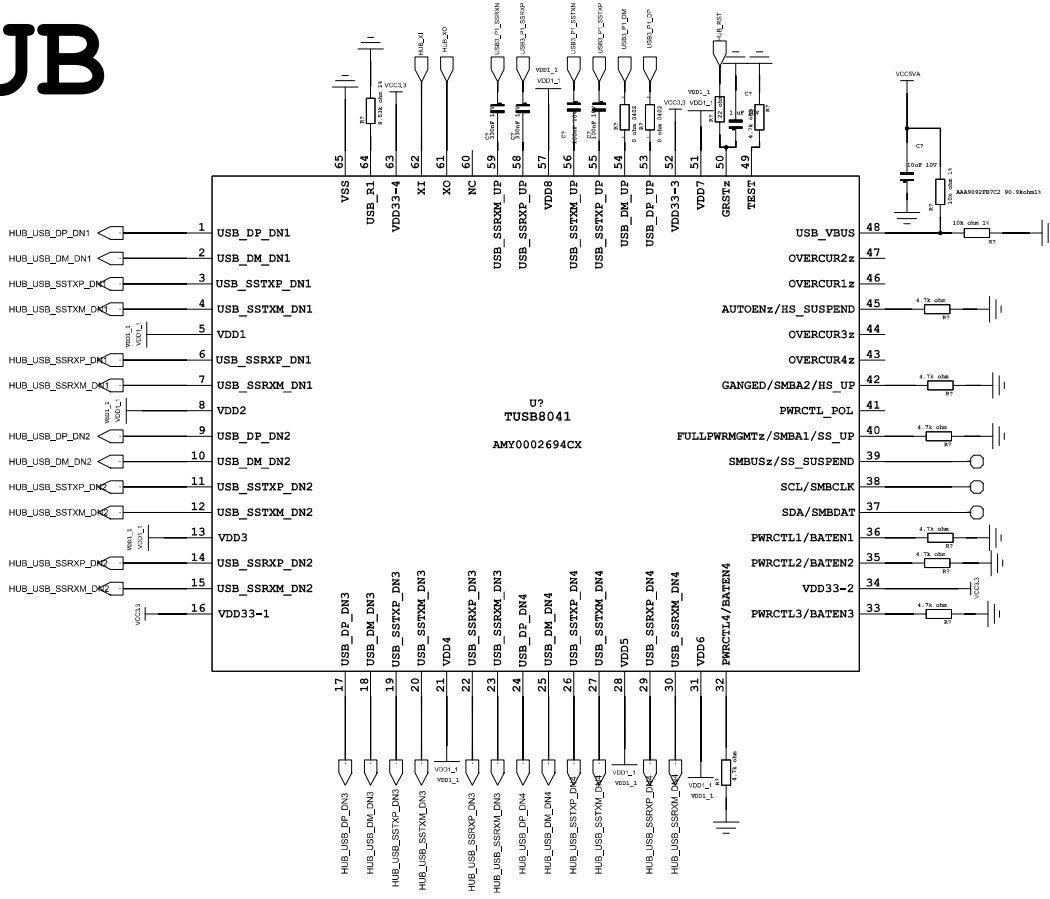
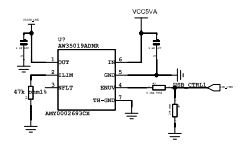

current lim: 1.91A-2.34A

USB3.0 Port 1

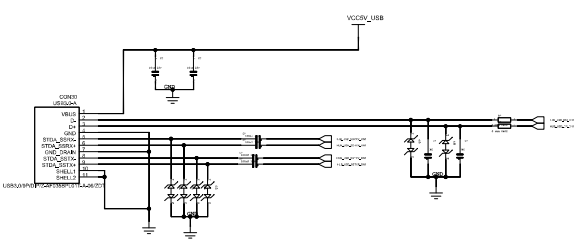

USB3.0 Port 2

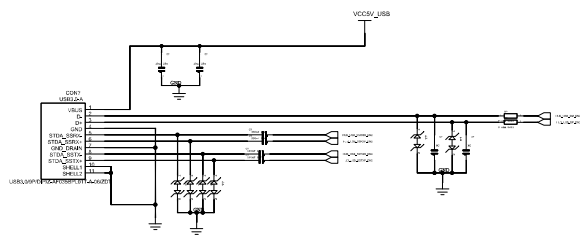

USB3.0 Port 3

