

FEATURES

- 2.7-V and 5-V Performance
- -40°C to 125°C Operation
- Low-Power Shutdown Mode (LMV324S)
- No Crossover Distortion
- Low Supply Current
 - LMV321 ... 130 μA Typ
 - LMV358 ... 210 μA Typ
 - LMV324 ... 410 μA Typ
 - LMV324S ... 410 μA Typ
- Rail-to-Rail Output Swing
- ESD Protection Exceeds JESD 22
 - 2000-V Human-Body Model (A114-A)
 - 1000-V Charged-Device Model (C101)

DESCRIPTION/ ORDERING INFORMATION

The LMV321, LMV358, and LMV324/LMV324S are single, dual, and quad low-voltage (2.7 V to 5.5 V) operational amplifiers with rail-to-rail output swing. The LMV324S, which is a variation of the standard LMV324, includes a power-saving shutdown feature that reduces supply current to a maximum of 5 μA per channel when the amplifiers are not needed. Channels 1 and 2 together are put in shutdown, as are channels 3 and 4. While in shutdown, the outputs actively are pulled low.

The LMV321, LMV358, LMV324, and LMV324S are the most cost-effective solutions for applications where low-voltage operation, space saving, and low cost are needed. These amplifiers are designed specifically for low-voltage (2.7 V to 5 V) operation, with performance specifications meeting or exceeding the LM358 and LM324 devices that operate from 5 V to 30 V. Additional features of the LMV3xx devices are a common-mode input voltage range that includes ground, 1-MHz unity-gain bandwidth, and 1-V/ μs slew rate.

The LMV321 is available in the ultra-small DCK (SC-70) package, which is approximately one-half the size of the DBV (SOT-23) package. This package saves space on printed circuit boards and enables the design of small portable electronic devices. It also allows the designer to place the device closer to the signal source to reduce noise pickup and increase signal integrity.

LMV324... D (SOIC) OR PW (TSSOP) PACKAGE
(TOP VIEW)

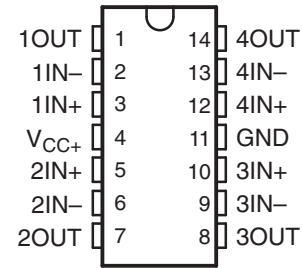

LMV324S... D (SOIC) OR PW (TSSOP) PACKAGE
(TOP VIEW)

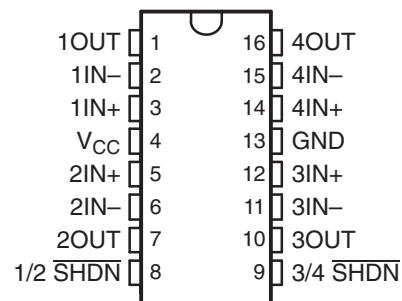

LMV358... D (SOIC), DDU (VSSOP),
DGK (MSOP), OR PW (TSSOP) PACKAGE
(TOP VIEW)

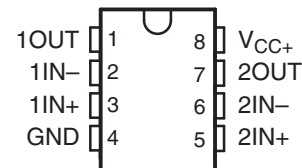

LMV321... DBV (SOT-23) OR DCK (SC-70) PACKAGE
(TOP VIEW)

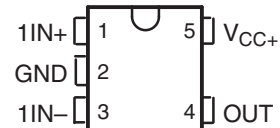

Please be aware that an important notice concerning availability, standard warranty, and use in critical applications of Texas Instruments semiconductor products and disclaimers thereto appears at the end of this data sheet.

**LMV321 SINGLE, LMV358 DUAL
LMV324 QUAD, LMV324S QUAD WITH SHUTDOWN
LOW-VOLTAGE RAIL-TO-RAIL OUTPUT OPERATIONAL AMPLIFIERS**

SLOS263T–AUGUST 1999–REVISED SEPTEMBER 2007

ORDERING INFORMATION⁽¹⁾

T _A	PACKAGE ⁽²⁾		ORDERABLE PART NUMBER	TOP-SIDE MARKING ⁽³⁾	
–40°C to 85°C	Single	SC-70 – DCK	Reel of 3000	LMV321IDCKR	R3_
			Reel of 250	LMV321IDCKT	
		SOT-23 – DBV	Reel of 3000	LMV321IDBVR	RC1_
			Reel of 250	LMV321IDBVT	
	Dual	MSOP/VSSOP – DGK	Reel of 2500	LMV358IDGKR	R5_
			Reel of 250	LMV358IDGKT	PREVIEW
		SOIC – D	Tube of 75	LMV358ID	MV358I
			Reel of 2500	LMV358IDR	
		TSSOP – PW	Tube of 150	LMV358IPW	MV358I
			Reel of 2000	LMV358IPWR	
	VSSOP – DDU	Reel of 3000	LMV358IDDUR	RA5_	
	Quad	SOIC – D	Tube of 50	LMV324ID	LMV324I
			Reel of 2500	LMV324IDR	
			Tube of 50	LMV324SID	LMV324SI
Reel of 2500			LMV324SIDR		
TSSOP – PW		Reel of 2000	LMV324IPWR	MV324I	
		Reel of 2000	LMV324SIPWR	MV324SI	
–40°C to 125°C	Dual	MSOP/VSSOP – DGK	Reel of 2500	LMV358QDGKR	RH_
			Reel of 250	LMV358QDGKT	
		SOIC – D	Tube of 75	LMV358QD	MV358Q
			Reel of 2500	LMV358QDR	
	TSSOP – PW	Tube of 150	LMV358QPW	MV358Q	
		Reel of 2000	LMV358QPWR		
	VSSOP – DDU	Reel of 3000	LMV358QDDUR	RAH_	
	Quad	SOIC – D	Tube of 50	LMV324QD	LMV324Q
			Reel of 2500	LMV324QDR	
		TSSOP – PW	Tube of 90	LMV324QPW	MV324Q
Reel of 2000			LMV324QPWR		

(1) For the most current package and ordering information, see the Package Option Addendum at the end of this document, or see the TI web site at www.ti.com.

(2) Package drawings, thermal data, and symbolization are available at www.ti.com/packaging.

(3) DBV/DCK/DDU/DGK: The actual top-side marking has one additional character that designates the wafer fab/assembly site.

SYMBOL (EACH AMPLIFIER)

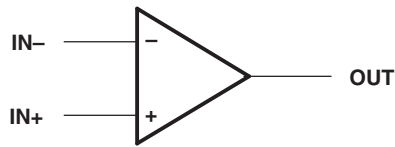

LMV324 SIMPLIFIED SCHEMATIC

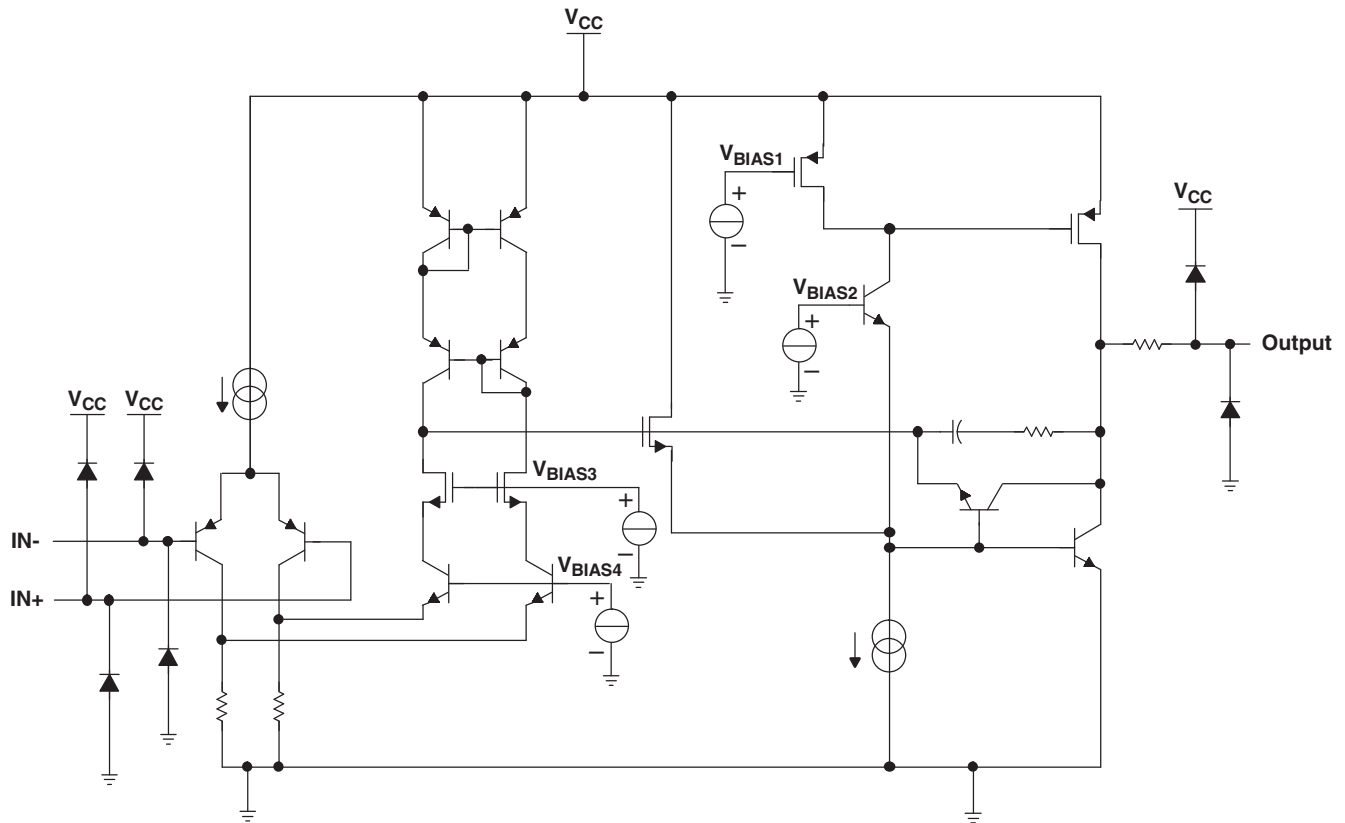

LMV321 SINGLE, LMV358 DUAL LMV324 QUAD, LMV324S QUAD WITH SHUTDOWN LOW-VOLTAGE RAIL-TO-RAIL OUTPUT OPERATIONAL AMPLIFIERS

SLOS263T–AUGUST 1999–REVISED SEPTEMBER 2007

Absolute Maximum Ratings⁽¹⁾

over operating free-air temperature range (unless otherwise noted)

		MIN	MAX	UNIT	
V _{CC}	Supply voltage ⁽²⁾		5.5	V	
V _{ID}	Differential input voltage ⁽³⁾		±5.5	V	
V _I	Input voltage range (either input)	–0.2	5.5	V	
Duration of output short circuit (one amplifier) to ground ⁽⁴⁾		At or below T _A = 25°C, V _{CC} ≤ 5.5 V		Unlimited	
θ _{JA}	Package thermal impedance ⁽⁵⁾⁽⁶⁾	D package	8 pin	97	°C/W
			14 pin	86	
			16 pin	73	
		DBV package	5 pin	206	
		DCK package	5 pin	252	
		DDU package	8 pin	TBD	
		DGK package	8 pin	172	
		PW package	8 pin	149	
		14 pin	113		
		16 pin	108		
T _J	Operating virtual junction temperature		150	°C	
T _{stg}	Storage temperature range	–65	150	°C	

- Stresses beyond those listed under *Absolute Maximum Ratings* may cause permanent damage to the device. These are stress ratings only, and functional operation of the device at these or any other conditions beyond those indicated under *Recommended Operating Conditions* is not implied. Exposure to absolute-maximum-rated conditions for extended periods may affect device reliability.
- All voltage values (except differential voltages and V_{CC} specified for the measurement of I_{OS}) are with respect to the network GND.
- Differential voltages are at IN+ with respect to IN–.
- Short circuits from outputs to V_{CC} can cause excessive heating and eventual destruction.
- Maximum power dissipation is a function of T_{J(max)}, θ_{JA}, and T_A. The maximum allowable power dissipation at any allowable ambient temperature is P_D = (T_{J(max)} – T_A)/θ_{JA}. Operating at the absolute maximum T_J of 150°C can affect reliability.
- The package thermal impedance is calculated in accordance with JESD 51-7.

Recommended Operating Conditions⁽¹⁾

		MIN	MAX	UNIT
V _{CC}	Supply voltage (single-supply operation)	2.7	5.5	V
V _{IH}	Amplifier turn-on voltage level (LMV324S) ⁽²⁾	V _{CC} = 2.7 V	1.7	V
		V _{CC} = 5 V	3.5	
V _{IL}	Amplifier turn-off voltage level (LMV324S)	V _{CC} = 2.7 V	0.7	V
		V _{CC} = 5 V	1.5	
T _A	Operating free-air temperature	I temperature	–40	°C
		Q temperature	–40	

- All unused control inputs of the device must be held at V_{CC} or GND to ensure proper device operation. See the TI application report, *Implications of Slow or Floating CMOS Inputs*, literature number [SCBA004](#).
- V_{IH} should not be allowed to exceed V_{CC}.

Electrical Characteristics

 $V_{CC+} = 2.7\text{ V}$, $T_A = 25^\circ\text{C}$ (unless otherwise noted)

PARAMETER		TEST CONDITIONS		MIN	TYP ⁽¹⁾	MAX	UNIT
V_{IO}	Input offset voltage				1.7	7	mV
α_{VIO}	Average temperature coefficient of input offset voltage				5		$\mu\text{V}/^\circ\text{C}$
I_{IB}	Input bias current				11	250	nA
I_{IO}	Input offset current				5	50	nA
CMRR	Common-mode rejection ratio	$V_{CM} = 0$ to 1.7 V		50	63		dB
k_{SVR}	Supply-voltage rejection ratio	$V_{CC} = 2.7\text{ V}$ to 5 V, $V_O = 1\text{ V}$		50	60		dB
V_{ICR}	Common-mode input voltage range	CMRR ≥ 50 dB		0	-0.2		V
					1.9	1.7	
V_O	Output swing	$R_L = 10\text{ k}\Omega$ to 1.35 V	High level	$V_{CC} - 100$	$V_{CC} - 10$		mV
			Low level		60	180	
I_{CC}	Supply current	LMV321I			80	170	μA
		LMV358I (both amplifiers)			140	340	
		LMV324I/LMV324SI (all four amplifiers)			260	680	
B_1	Unity-gain bandwidth	$C_L = 200\text{ pF}$			1		MHz
Φ_m	Phase margin				60		deg
G_m	Gain margin				10		dB
V_n	Equivalent input noise voltage	$f = 1\text{ kHz}$			46		$\text{nV}/\sqrt{\text{Hz}}$
I_n	Equivalent input noise current	$f = 1\text{ kHz}$			0.17		$\text{pA}/\sqrt{\text{Hz}}$

(1) Typical values represent the likely parametric nominal values determined at the time of characterization. Typical values depend on the application and configuration and may vary over time. Typical values are not ensured on production material.

Shutdown Characteristics (LMV324S)

 $V_{CC+} = 2.7\text{ V}$, $T_A = 25^\circ\text{C}$ (unless otherwise noted)

PARAMETER		TEST CONDITIONS		MIN	TYP ⁽¹⁾	MAX	UNIT
$I_{CC(\text{SHDN})}$	Supply current in shutdown mode (per channel)	$\overline{\text{SHDN}} \leq 0.6\text{ V}$				5	μA
$t_{(\text{on})}$	Amplifier turn-on time	$A_V = 1$, $R_L = \text{Open}$ (measured at 50% point)			2		μs
$t_{(\text{off})}$	Amplifier turn-off time	$A_V = 1$, $R_L = \text{Open}$ (measured at 50% point)			40		ns

(1) Typical values represent the likely parametric nominal values determined at the time of characterization. Typical values depend on the application and configuration and may vary over time. Typical values are not ensured on production material.

**LMV321 SINGLE, LMV358 DUAL
LMV324 QUAD, LMV324S QUAD WITH SHUTDOWN
LOW-VOLTAGE RAIL-TO-RAIL OUTPUT OPERATIONAL AMPLIFIERS**

SLOS263T–AUGUST 1999–REVISED SEPTEMBER 2007

Electrical Characteristics

$V_{CC+} = 5\text{ V}$, at specified free-air temperature (unless otherwise noted)

PARAMETER		TEST CONDITIONS		$T_A^{(1)}$	MIN	TYP ⁽²⁾	MAX	UNIT
V_{IO}	Input offset voltage			25°C		1.7	7	mV
				Full range			9	
α_{VIO}	Average temperature coefficient of input offset voltage			25°C		5		$\mu\text{V}/^\circ\text{C}$
I_{IB}	Input bias current			25°C		15	250	nA
				Full range			500	
I_{IO}	Input offset current			25°C		5	50	nA
				Full range			150	
CMRR	Common-mode rejection ratio	$V_{CM} = 0\text{ to }4\text{ V}$		25°C	50	65		dB
k_{SVR}	Supply-voltage rejection ratio	$V_{CC} = 2.7\text{ V to }5\text{ V}$, $V_O = 1\text{ V}$, $V_{CM} = 1\text{ V}$		25°C	50	60		dB
V_{ICR}	Common-mode input voltage range	CMRR $\geq 50\text{ dB}$		25°C	0	-0.2		V
						4.2	4	
V_O	Output swing	$R_L = 2\text{ k}\Omega\text{ to }2.5\text{ V}$	High level	25°C	$V_{CC} - 300$	$V_{CC} - 40$		mV
				Full range		$V_{CC} - 400$		
			Low level	25°C		120	300	
				Full range			400	
		$R_L = 10\text{ k}\Omega\text{ to }2.5\text{ V}$	High level	25°C	$V_{CC} - 100$	$V_{CC} - 10$		
				Full range		$V_{CC} - 200$		
			Low level	25°C		65	180	
				Full range			280	
A_{VD}	Large-signal differential voltage gain	$R_L = 2\text{ k}\Omega$		25°C	15	100		V/mV
				Full range		10		
I_{OS}	Output short-circuit current	Sourcing, $V_O = 0\text{ V}$		25°C	5	60		mA
		Sinking, $V_O = 5\text{ V}$			10	160		
I_{CC}	Supply current	LMV321I		25°C		130	250	μA
				Full range			350	
		LMV358I (both amplifiers)		25°C		210	440	
				Full range			615	
		LMV324I/LMV324SI (all four amplifiers)		25°C		410	830	
				Full range			1160	
B_1	Unity-gain bandwidth	$C_L = 200\text{ pF}$		25°C		1		MHz
Φ_m	Phase margin			25°C		60		deg
G_m	Gain margin			25°C		10		dB
V_n	Equivalent input noise voltage	$f = 1\text{ kHz}$		25°C		39		$\text{nV}/\sqrt{\text{Hz}}$
I_n	Equivalent input noise current	$f = 1\text{ kHz}$		25°C		0.21		$\text{pA}/\sqrt{\text{Hz}}$
SR	Slew rate			25°C		1		V/ μs

(1) Full range $T_A = -40^\circ\text{C}$ to 85°C for I temperature and -40°C to 125°C for Q temperature.

(2) Typical values represent the likely parametric nominal values determined at the time of characterization. Typical values depend on the application and configuration and may vary over time. Typical values are not ensured on production material.

Shutdown Characteristics (LMV324S)
 $V_{CC+} = 5\text{ V}$, $T_A = 25^\circ\text{C}$ (unless otherwise noted)

PARAMETER		TEST CONDITIONS	MIN	TYP ⁽¹⁾	MAX	UNIT
$I_{CC(SHDN)}$	Supply current in shutdown mode (per channel)	$\overline{SHDN} \leq 0.6\text{ V}$, $T_A = -40^\circ\text{C}$ to 85°C			5	μA
$t_{(on)}$	Amplifier turn-on time	$A_V = 1$, $R_L = \text{Open}$ (measured at 50% point)		2		μs
$t_{(off)}$	Amplifier turn-off time	$A_V = 1$, $R_L = \text{Open}$ (measured at 50% point)		40		ns

- (1) Typical values represent the likely parametric nominal values determined at the time of characterization. Typical values depend on the application and configuration and may vary over time. Typical values are not ensured on production material.

TYPICAL CHARACTERISTICS

LMV321 FREQUENCY RESPONSE
 VS
 RESISTIVE LOAD

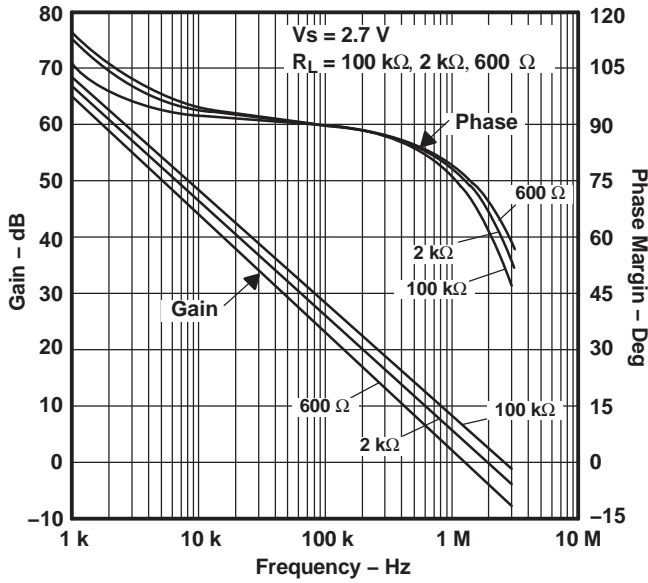

Figure 1.

LMV321 FREQUENCY RESPONSE
 VS
 RESISTIVE LOAD

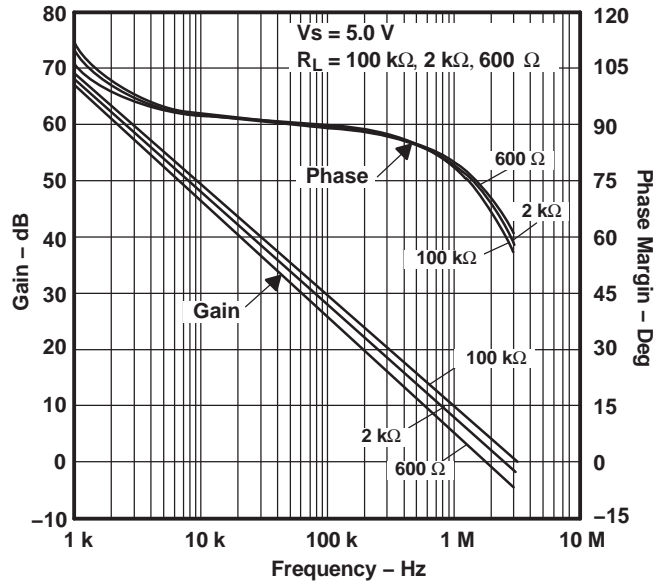

Figure 2.

LMV321 FREQUENCY RESPONSE
 VS
 CAPACITIVE LOAD

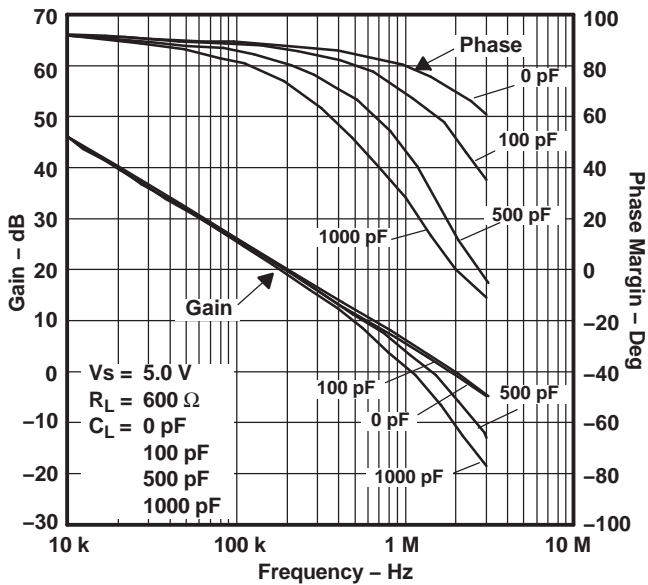

Figure 3.

LMV321 FREQUENCY RESPONSE
 VS
 CAPACITIVE LOAD

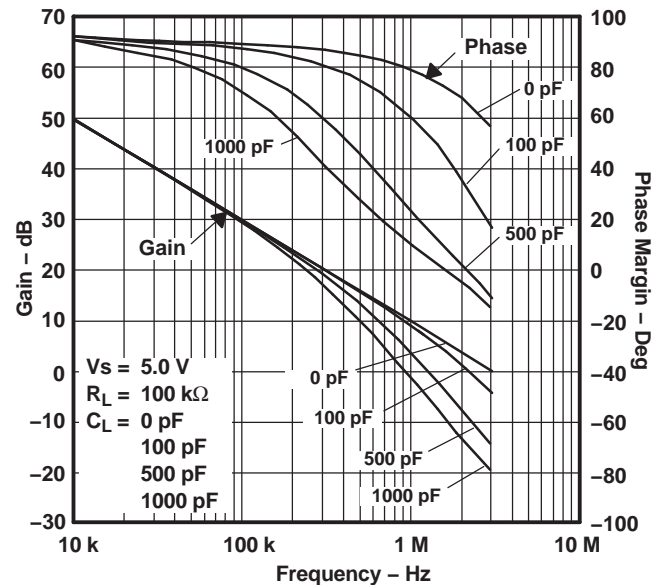

Figure 4.

TYPICAL CHARACTERISTICS (continued)

LMV321 FREQUENCY RESPONSE
VS
TEMPERATURE

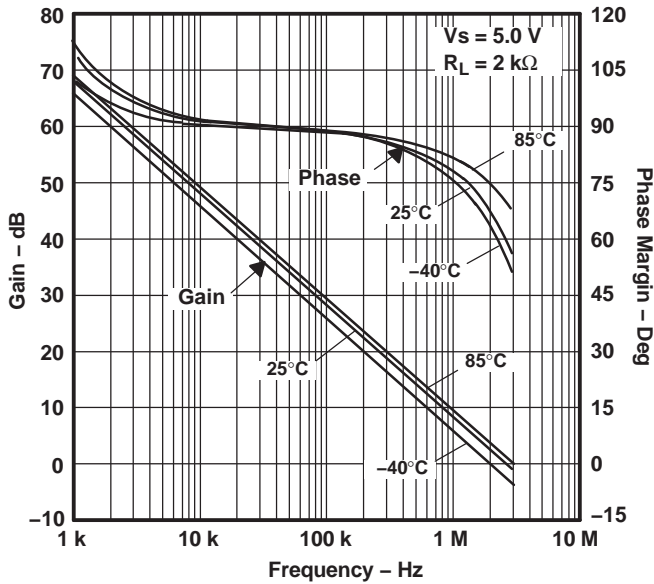

Figure 5.

STABILITY

VS
CAPACITIVE LOAD

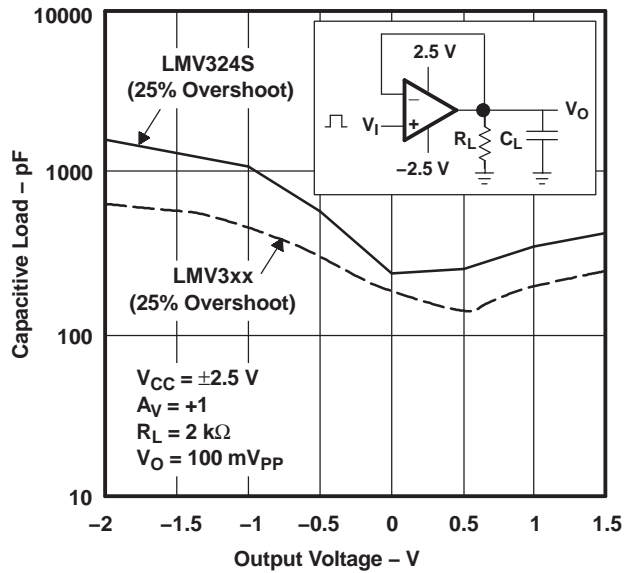

Figure 6.

STABILITY
VS
CAPACITIVE LOAD

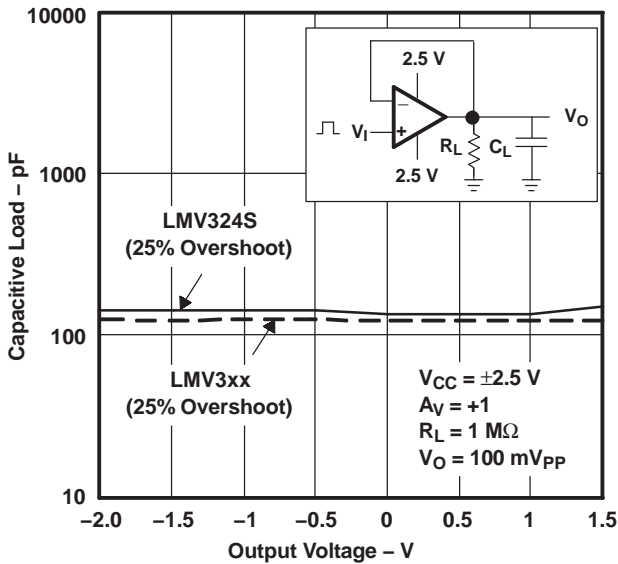

Figure 7.

STABILITY
VS
CAPACITIVE LOAD

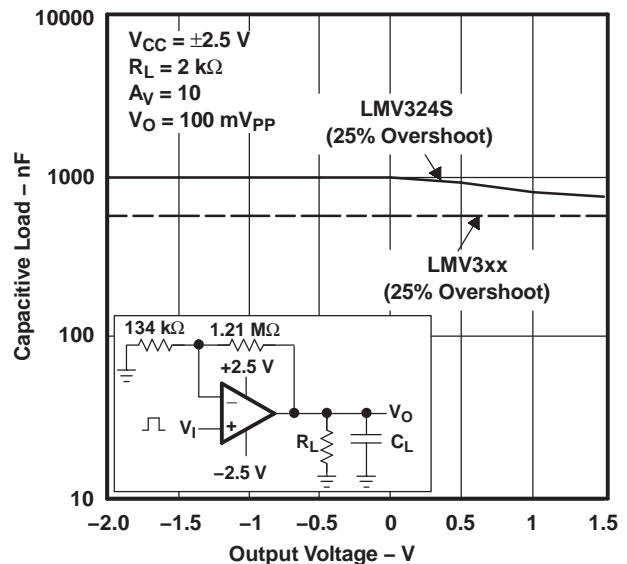
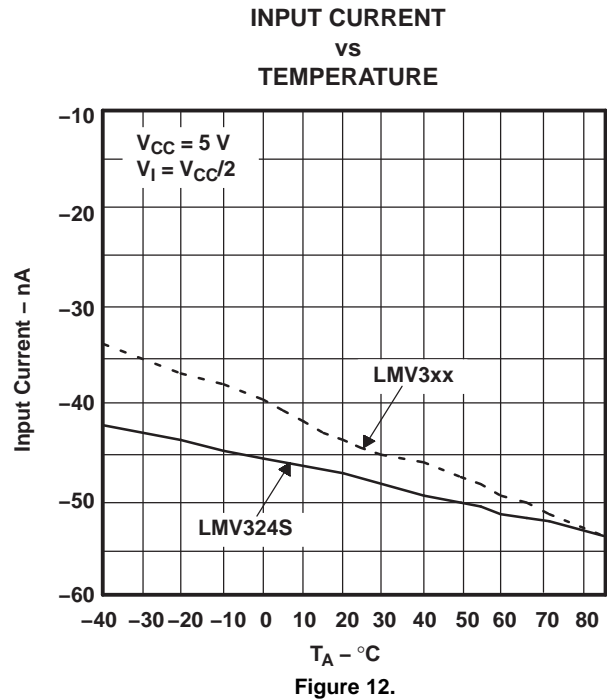
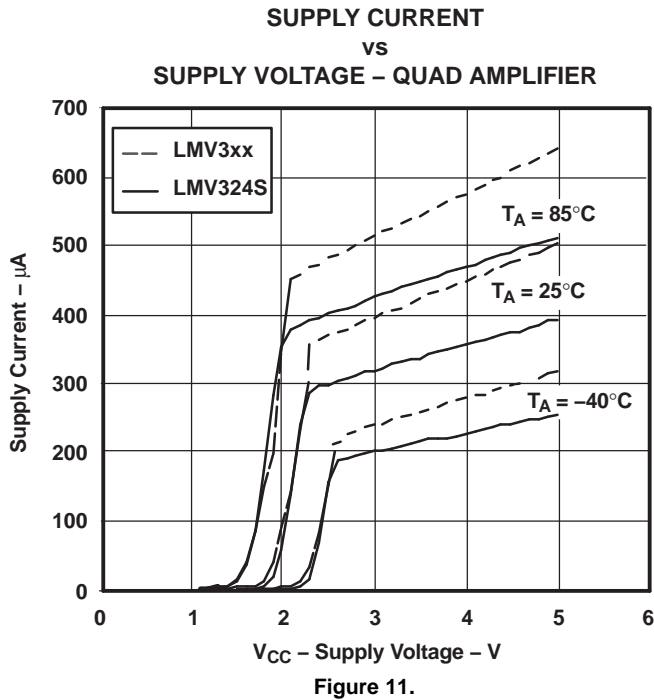
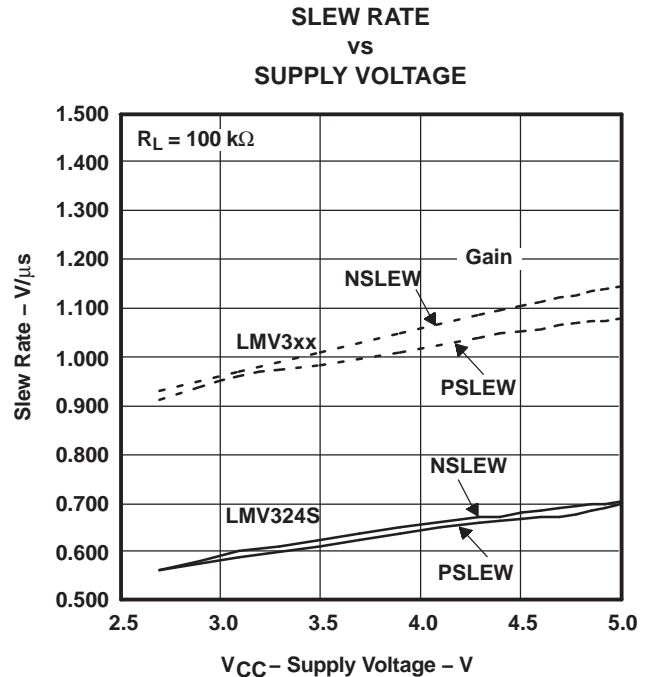
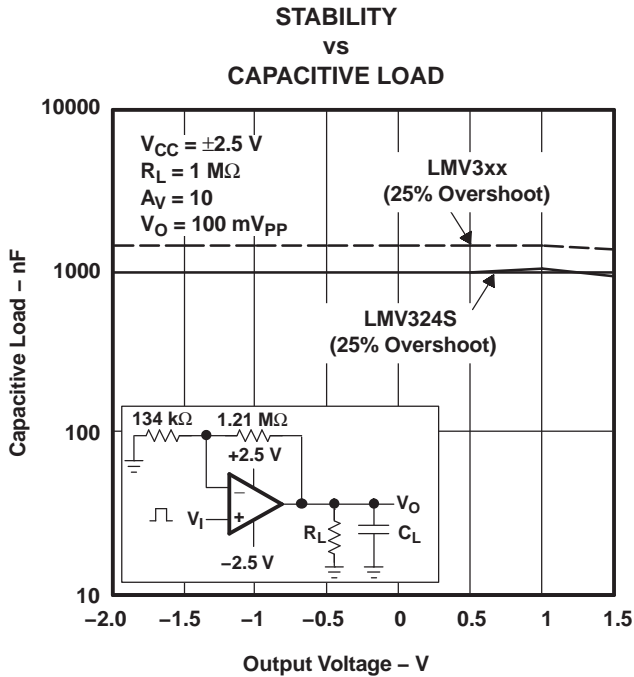
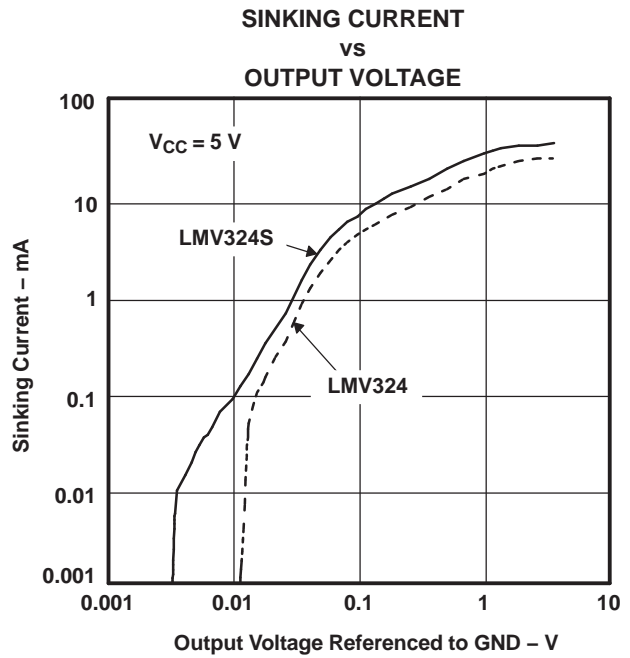
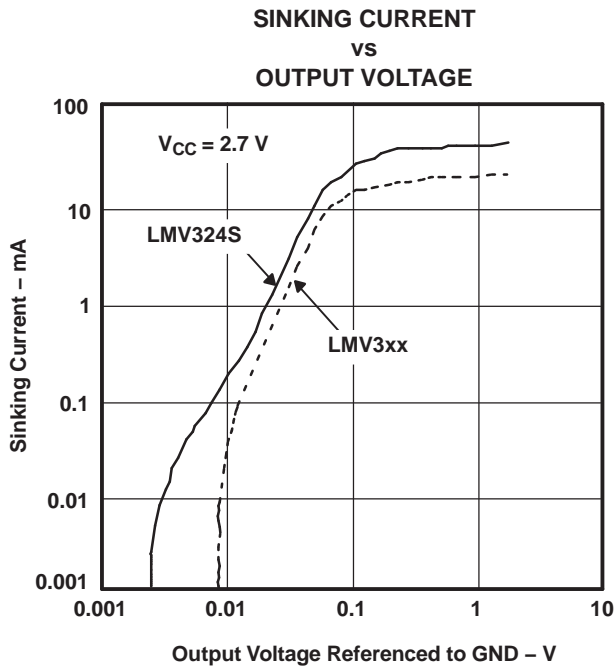
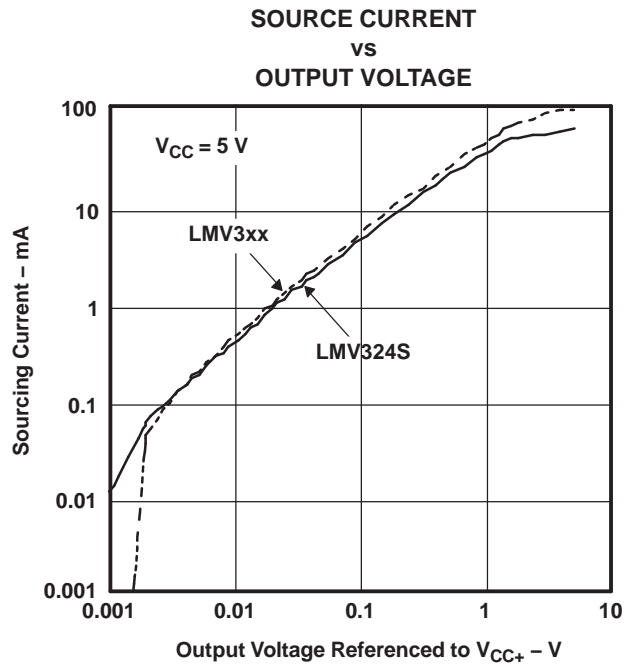
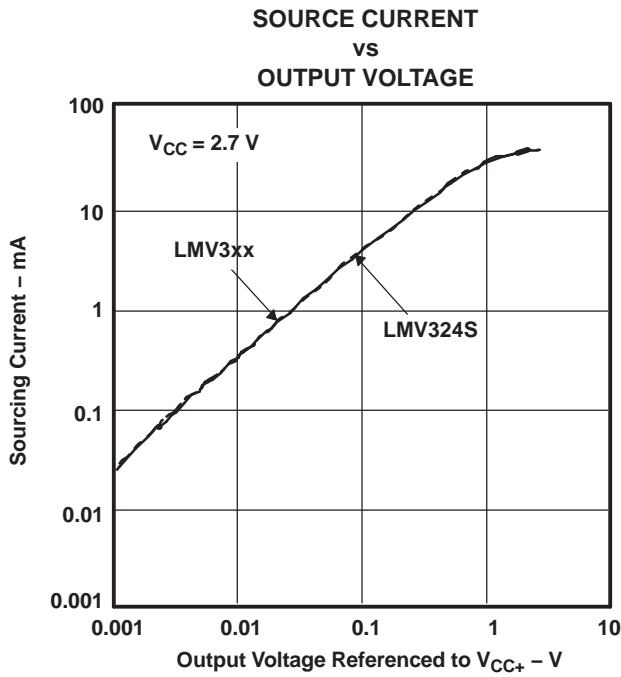

Figure 8.

TYPICAL CHARACTERISTICS (continued)



TYPICAL CHARACTERISTICS (continued)



TYPICAL CHARACTERISTICS (continued)

SHORT-CIRCUIT CURRENT
 vs
 TEMPERATURE

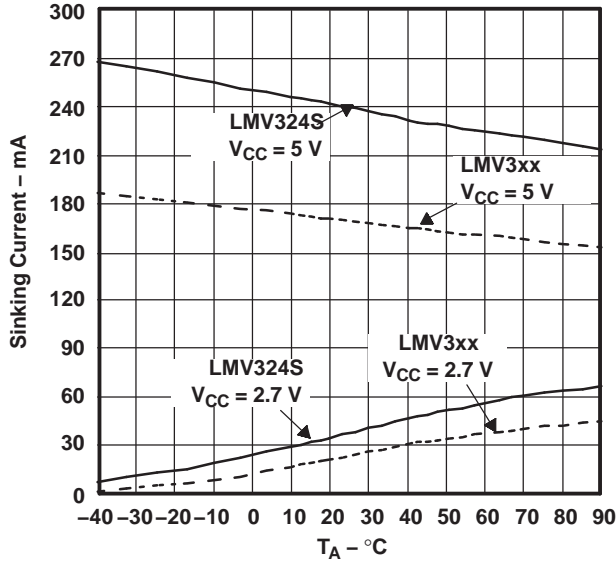

Figure 17.

SHORT-CIRCUIT CURRENT
 vs
 TEMPERATURE

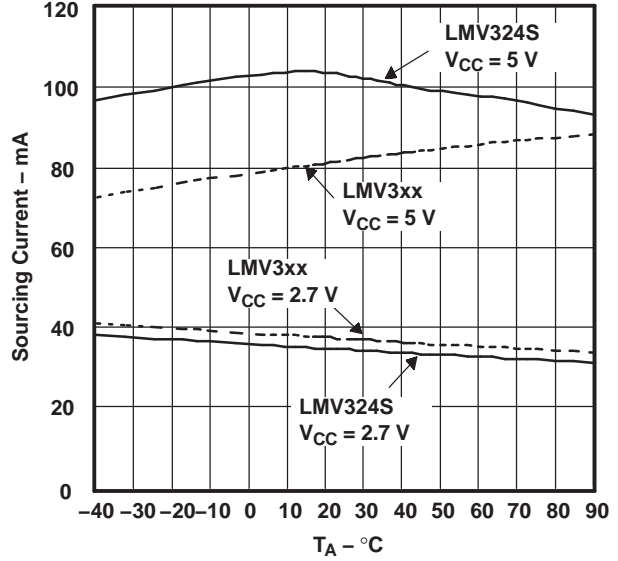

Figure 18.

-k_{SVR}
 vs
 FREQUENCY

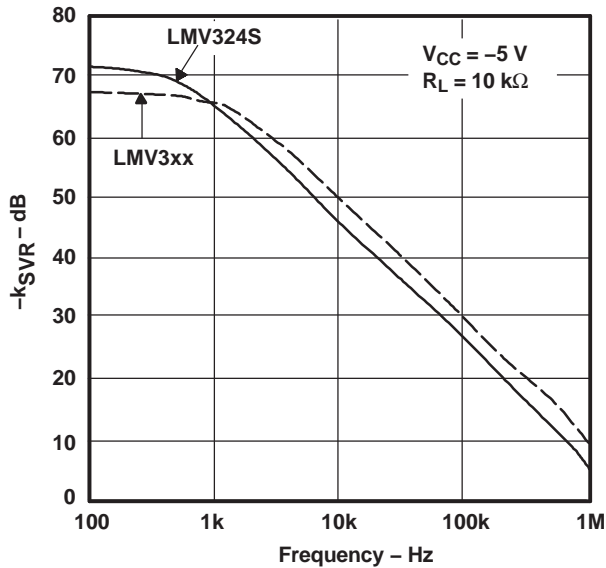

Figure 19.

+k_{SVR}
 vs
 FREQUENCY

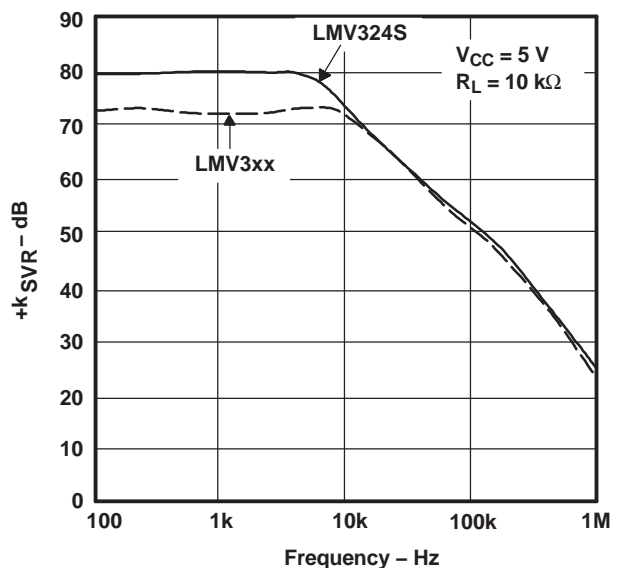

Figure 20.

TYPICAL CHARACTERISTICS (continued)

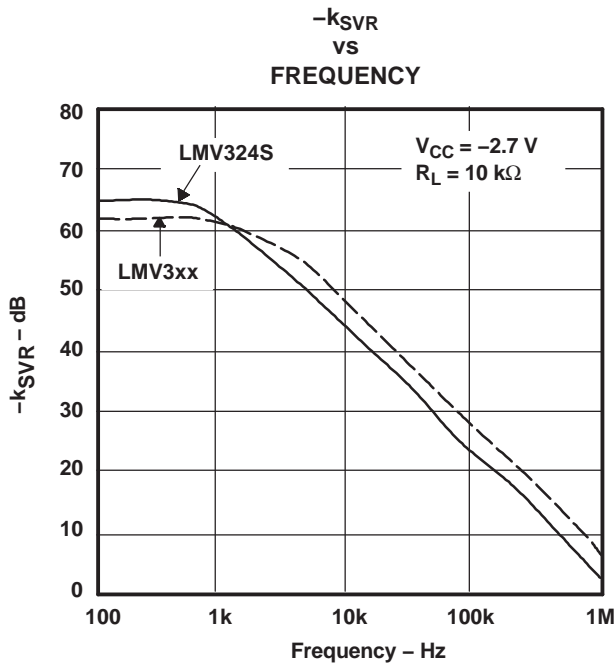

Figure 21.

OUTPUT VOLTAGE SWING FROM RAILS
vs
SUPPLY VOLTAGE

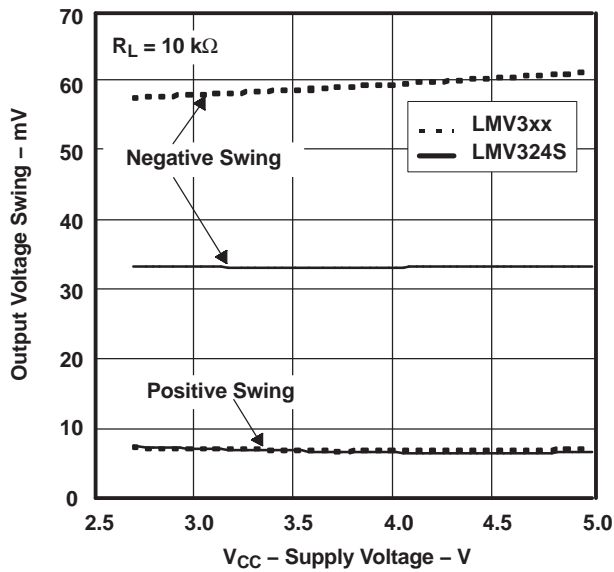

Figure 23.

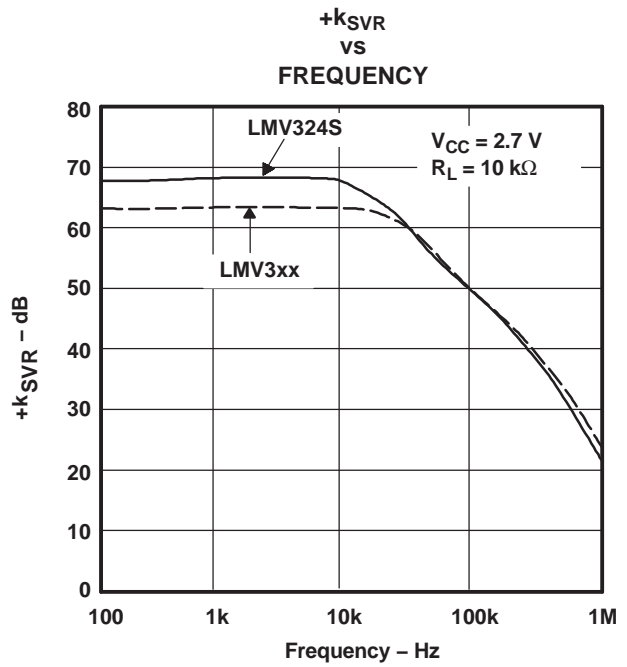

Figure 22.

OUTPUT VOLTAGE
vs
FREQUENCY

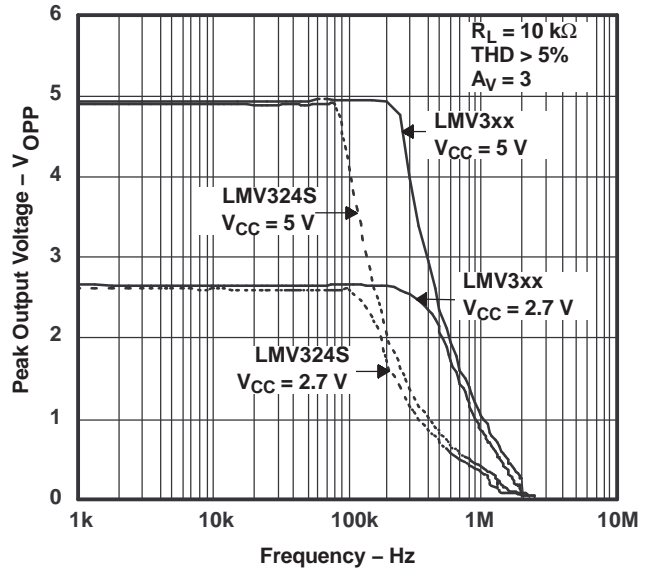

Figure 24.

TYPICAL CHARACTERISTICS (continued)

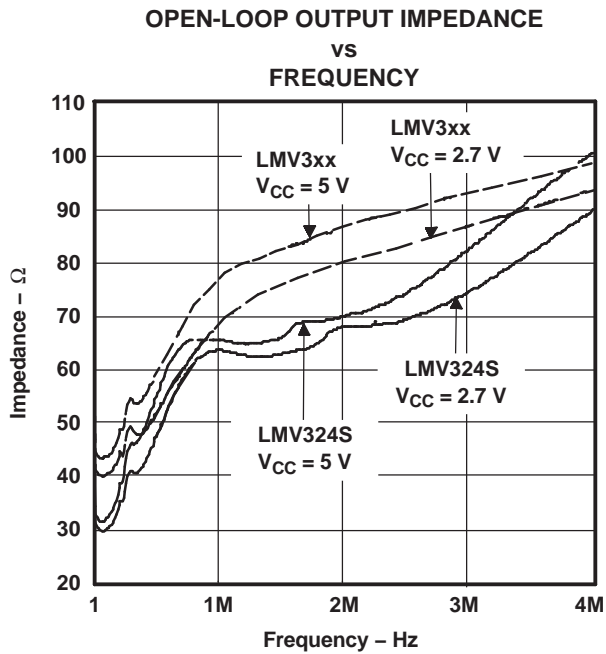

Figure 25.

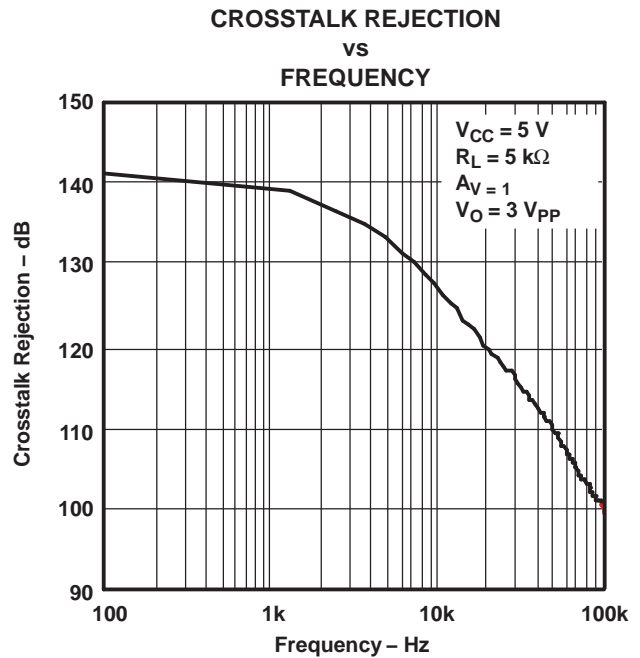
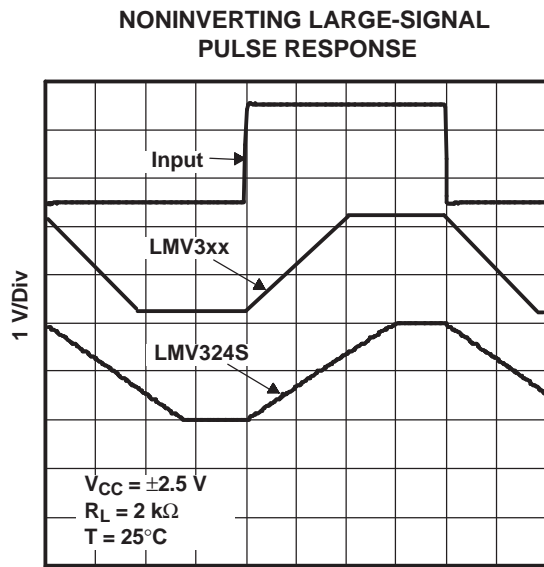
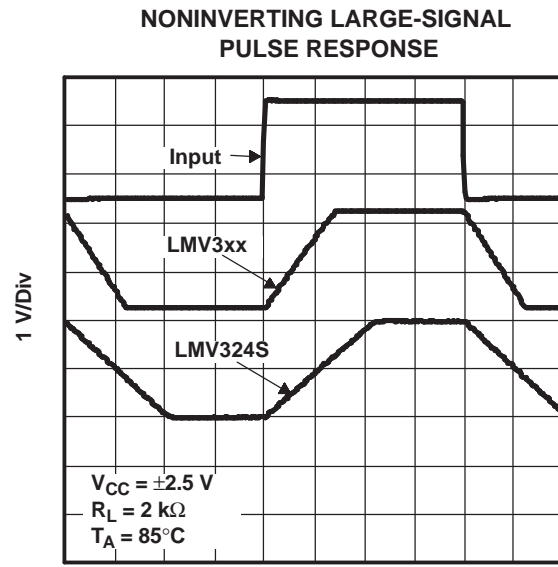

Figure 26.



1 μs/Div
 Figure 27.



1 μs/Div
 Figure 28.

TYPICAL CHARACTERISTICS (continued)

NONINVERTING LARGE-SIGNAL PULSE RESPONSE

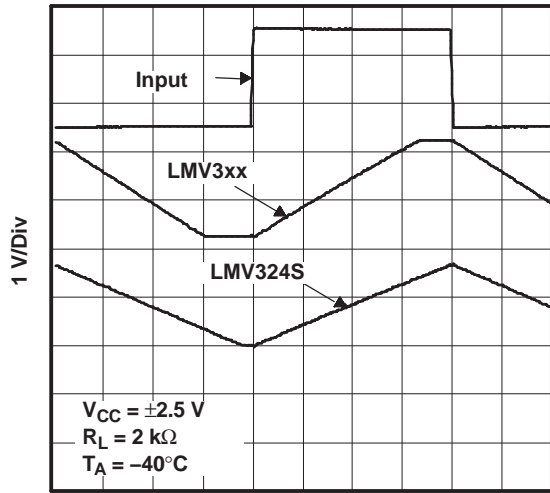

1 $\mu\text{s}/\text{Div}$
Figure 29.

NONINVERTING SMALL-SIGNAL PULSE RESPONSE

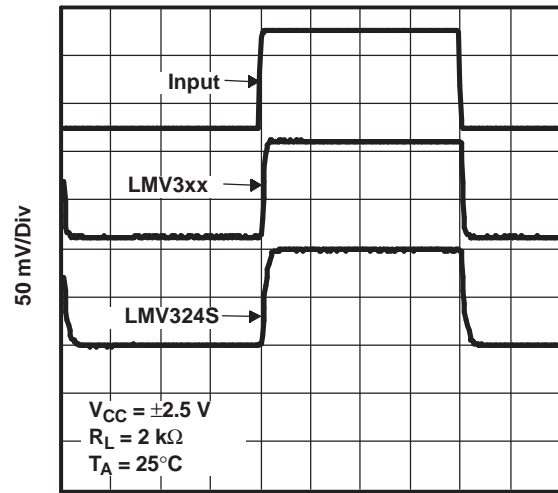

1 $\mu\text{s}/\text{Div}$
Figure 30.

NONINVERTING SMALL-SIGNAL PULSE RESPONSE

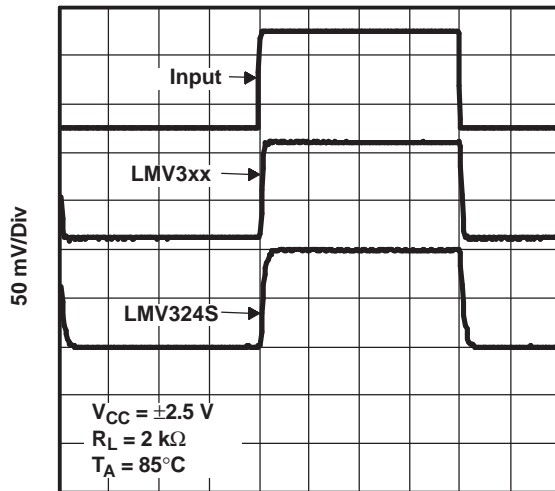

1 $\mu\text{s}/\text{Div}$
Figure 31.

NONINVERTING SMALL-SIGNAL PULSE RESPONSE

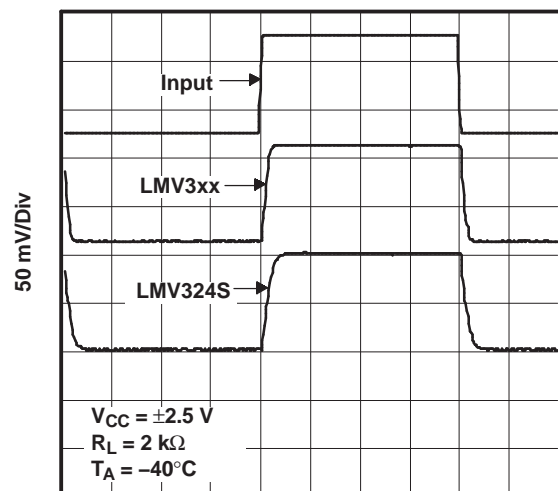

1 $\mu\text{s}/\text{Div}$
Figure 32.

TYPICAL CHARACTERISTICS (continued)

INVERTING LARGE-SIGNAL
 PULSE RESPONSE

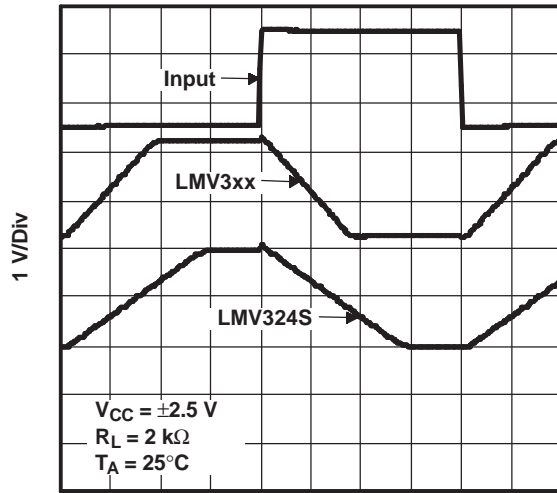

1 μs/Div
 Figure 33.

INVERTING LARGE-SIGNAL
 PULSE RESPONSE

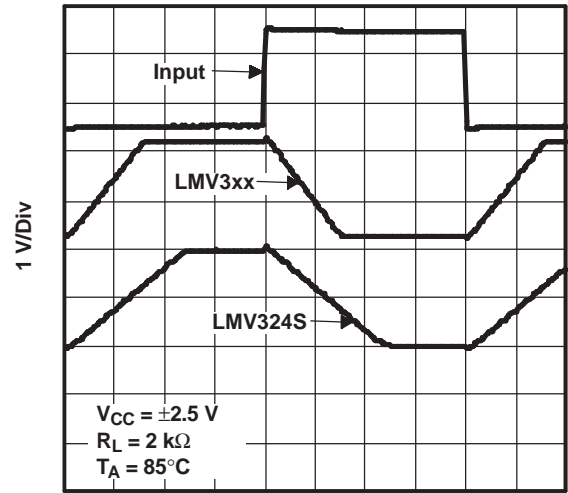

1 μs/Div
 Figure 34.

INVERTING LARGE-SIGNAL
 PULSE RESPONSE

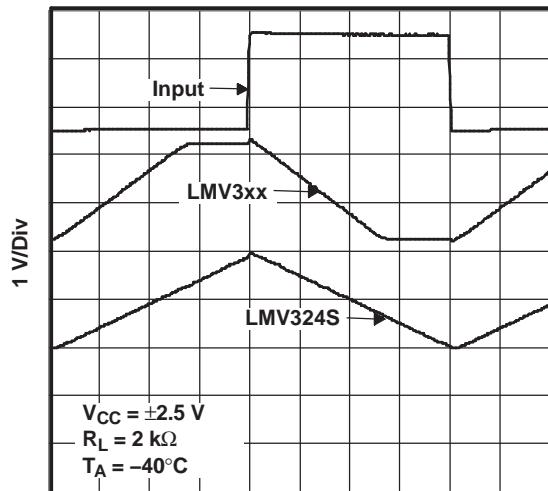

1 μs/Div
 Figure 35.

INVERTING SMALL-SIGNAL
 PULSE RESPONSE

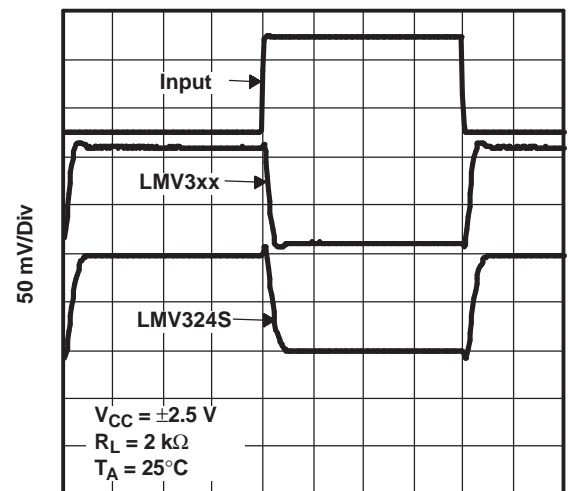

1 μs/Div
 Figure 36.

TYPICAL CHARACTERISTICS (continued)

INVERTING SMALL-SIGNAL PULSE RESPONSE

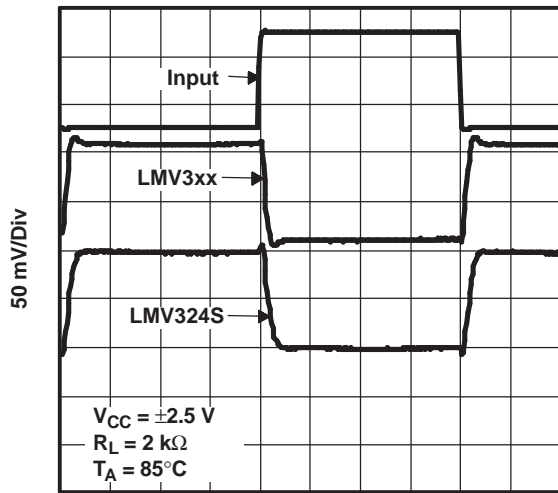

1 μs/Div

Figure 37.

INVERTING SMALL-SIGNAL PULSE RESPONSE

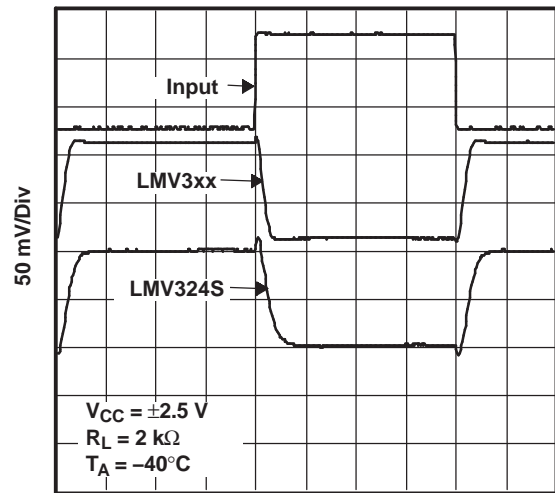

1 μs/Div

Figure 38.

INPUT CURRENT NOISE vs FREQUENCY

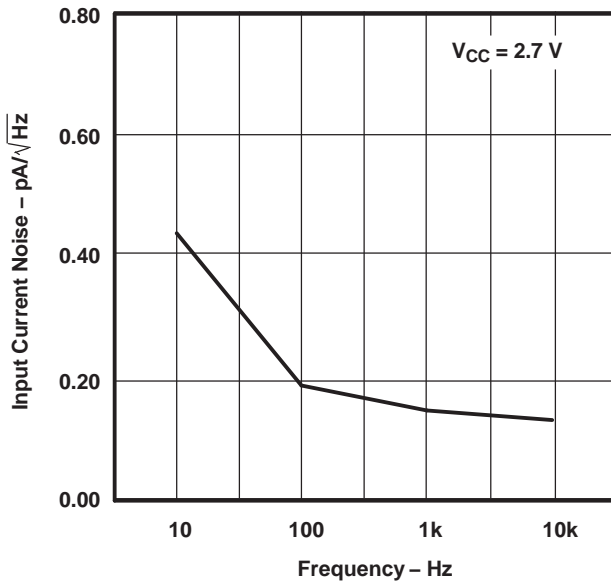

Figure 39.

INPUT CURRENT NOISE vs FREQUENCY

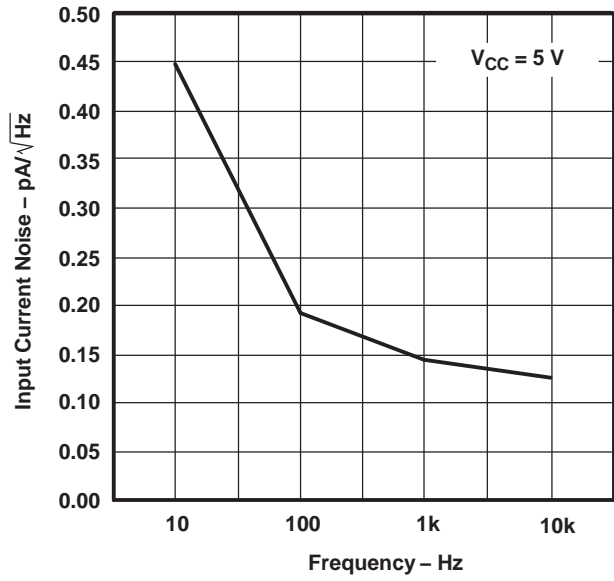

Figure 40.

TYPICAL CHARACTERISTICS (continued)

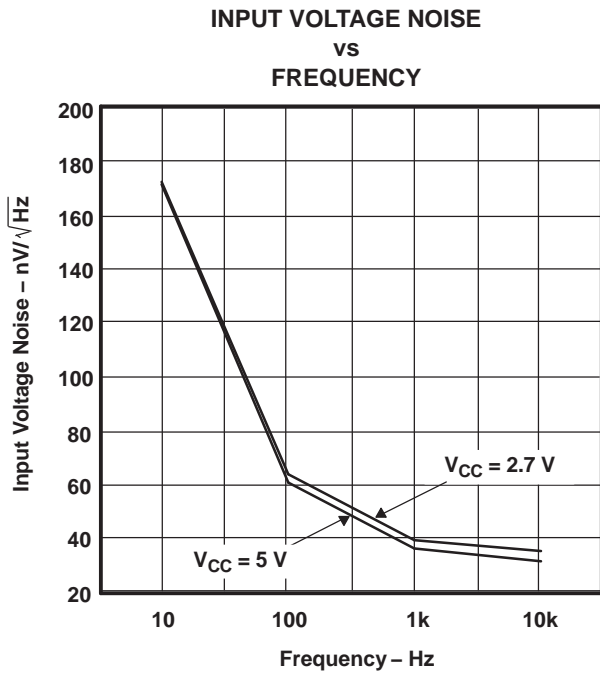

Figure 41.
 THD + N

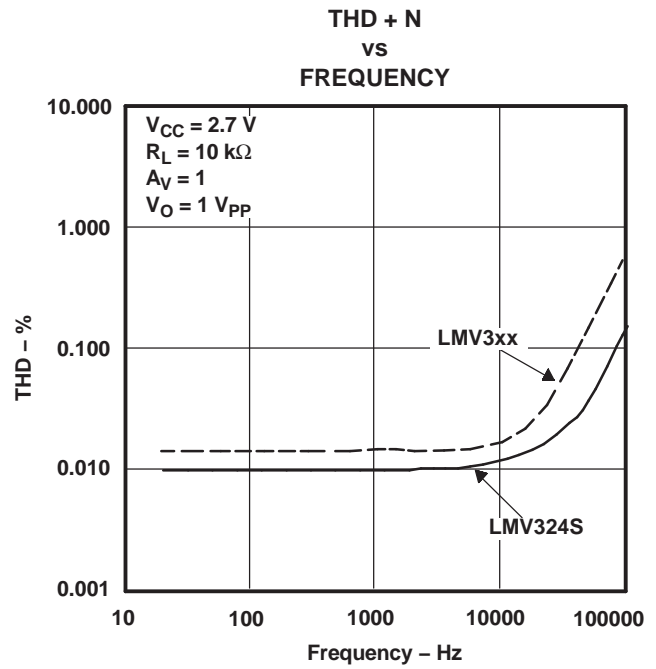

Figure 42.
 THD + N

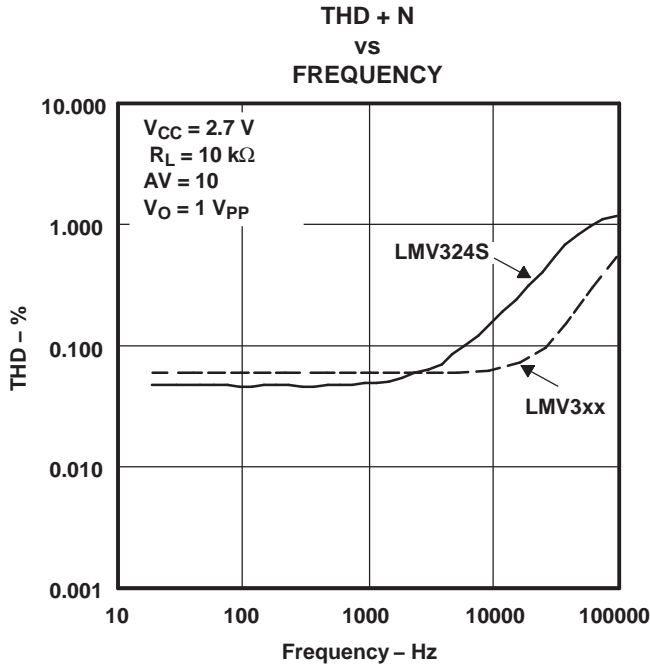

Figure 43.

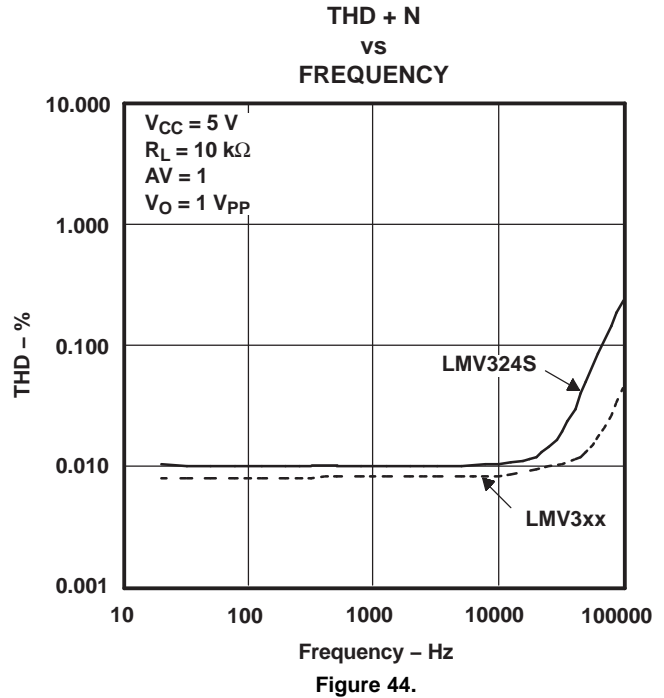
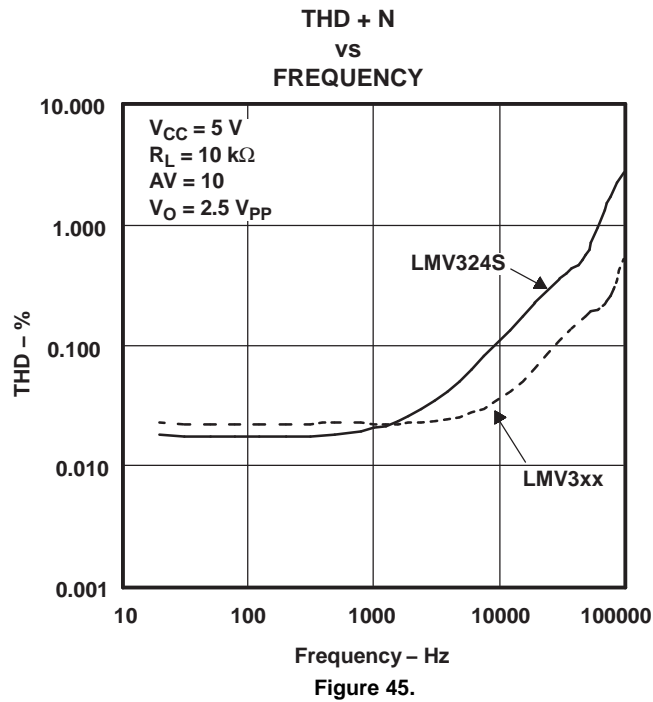

Figure 44.

TYPICAL CHARACTERISTICS (continued)



PACKAGING INFORMATION

Orderable Device	Status ⁽¹⁾	Package Type	Package Drawing	Pins	Package Qty	Eco Plan ⁽²⁾	Lead/Ball Finish	MSL Peak Temp ⁽³⁾
LMV321IDBVR	ACTIVE	SOT-23	DBV	5	3000	Green (RoHS & no Sb/Br)	CU NIPDAU	Level-1-260C-UNLIM
LMV321IDBVRG4	ACTIVE	SOT-23	DBV	5	3000	Green (RoHS & no Sb/Br)	CU NIPDAU	Level-1-260C-UNLIM
LMV321IDBVT	ACTIVE	SOT-23	DBV	5	250	Green (RoHS & no Sb/Br)	CU NIPDAU	Level-1-260C-UNLIM
LMV321IDBVTE4	ACTIVE	SOT-23	DBV	5	250	Green (RoHS & no Sb/Br)	CU NIPDAU	Level-1-260C-UNLIM
LMV321IDBVTG4	ACTIVE	SOT-23	DBV	5	250	Green (RoHS & no Sb/Br)	CU NIPDAU	Level-1-260C-UNLIM
LMV321IDCKR	ACTIVE	SC70	DCK	5	3000	Green (RoHS & no Sb/Br)	CU NIPDAU	Level-1-260C-UNLIM
LMV321IDCKRG4	ACTIVE	SC70	DCK	5	3000	Green (RoHS & no Sb/Br)	CU NIPDAU	Level-1-260C-UNLIM
LMV321IDCKT	ACTIVE	SC70	DCK	5	250	Green (RoHS & no Sb/Br)	CU NIPDAU	Level-1-260C-UNLIM
LMV321IDCKTE4	ACTIVE	SC70	DCK	5	250	Green (RoHS & no Sb/Br)	CU NIPDAU	Level-1-260C-UNLIM
LMV321IDCKTG4	ACTIVE	SC70	DCK	5	250	Green (RoHS & no Sb/Br)	CU NIPDAU	Level-1-260C-UNLIM
LMV324ID	ACTIVE	SOIC	D	14	50	Green (RoHS & no Sb/Br)	CU NIPDAU	Level-1-260C-UNLIM
LMV324IDG4	ACTIVE	SOIC	D	14	50	Green (RoHS & no Sb/Br)	CU NIPDAU	Level-1-260C-UNLIM
LMV324IDR	ACTIVE	SOIC	D	14	2500	Green (RoHS & no Sb/Br)	CU NIPDAU	Level-1-260C-UNLIM
LMV324IDRG4	ACTIVE	SOIC	D	14	2500	Green (RoHS & no Sb/Br)	CU NIPDAU	Level-1-260C-UNLIM
LMV324IDRG4Q1	ACTIVE	SOIC	D	14	2500	Green (RoHS & no Sb/Br)	CU NIPDAU	Level-1-260C-UNLIM
LMV324IPWR	ACTIVE	TSSOP	PW	14	2000	Green (RoHS & no Sb/Br)	CU NIPDAU	Level-1-260C-UNLIM
LMV324IPWRG4	ACTIVE	TSSOP	PW	14	2000	Green (RoHS & no Sb/Br)	CU NIPDAU	Level-1-260C-UNLIM
LMV324QD	ACTIVE	SOIC	D	14	50	Green (RoHS & no Sb/Br)	CU NIPDAU	Level-1-260C-UNLIM
LMV324QDG4	ACTIVE	SOIC	D	14	50	Green (RoHS & no Sb/Br)	CU NIPDAU	Level-1-260C-UNLIM
LMV324QDR	ACTIVE	SOIC	D	14	2500	Green (RoHS & no Sb/Br)	CU NIPDAU	Level-1-260C-UNLIM
LMV324QDRG4	ACTIVE	SOIC	D	14	2500	Green (RoHS & no Sb/Br)	CU NIPDAU	Level-1-260C-UNLIM
LMV324QPW	ACTIVE	TSSOP	PW	14	90	Green (RoHS & no Sb/Br)	CU NIPDAU	Level-1-260C-UNLIM
LMV324QPWE4	ACTIVE	TSSOP	PW	14	90	Green (RoHS & no Sb/Br)	CU NIPDAU	Level-1-260C-UNLIM
LMV324QPWG4	ACTIVE	TSSOP	PW	14	90	Green (RoHS & no Sb/Br)	CU NIPDAU	Level-1-260C-UNLIM
LMV324QPWR	ACTIVE	TSSOP	PW	14	2000	Green (RoHS & no Sb/Br)	CU NIPDAU	Level-1-260C-UNLIM

Orderable Device	Status ⁽¹⁾	Package Type	Package Drawing	Pins	Package Qty	Eco Plan ⁽²⁾	Lead/Ball Finish	MSL Peak Temp ⁽³⁾
LMV324QPWRG4	ACTIVE	TSSOP	PW	14	2000	Green (RoHS & no Sb/Br)	CU NIPDAU	Level-1-260C-UNLIM
LMV324SID	ACTIVE	SOIC	D	16	40	Green (RoHS & no Sb/Br)	CU NIPDAU	Level-1-260C-UNLIM
LMV324SIDE4	ACTIVE	SOIC	D	16	40	Green (RoHS & no Sb/Br)	CU NIPDAU	Level-1-260C-UNLIM
LMV324SIDG4	ACTIVE	SOIC	D	16	40	Green (RoHS & no Sb/Br)	CU NIPDAU	Level-1-260C-UNLIM
LMV324SIDR	ACTIVE	SOIC	D	16	2500	Green (RoHS & no Sb/Br)	CU NIPDAU	Level-1-260C-UNLIM
LMV324SIDRE4	ACTIVE	SOIC	D	16	2500	Green (RoHS & no Sb/Br)	CU NIPDAU	Level-1-260C-UNLIM
LMV324SIDRG4	ACTIVE	SOIC	D	16	2500	Green (RoHS & no Sb/Br)	CU NIPDAU	Level-1-260C-UNLIM
LMV324SIPWR	ACTIVE	TSSOP	PW	16	2000	Green (RoHS & no Sb/Br)	CU NIPDAU	Level-1-260C-UNLIM
LMV324SIPWRE4	ACTIVE	TSSOP	PW	16	2000	Green (RoHS & no Sb/Br)	CU NIPDAU	Level-1-260C-UNLIM
LMV324SIPWRG4	ACTIVE	TSSOP	PW	16	2000	Green (RoHS & no Sb/Br)	CU NIPDAU	Level-1-260C-UNLIM
LMV358ID	ACTIVE	SOIC	D	8	75	Green (RoHS & no Sb/Br)	CU NIPDAU	Level-1-260C-UNLIM
LMV358IDDUR	ACTIVE	VSSOP	DDU	8	3000	Green (RoHS & no Sb/Br)	CU NIPDAU	Level-1-260C-UNLIM
LMV358IDDURE4	ACTIVE	VSSOP	DDU	8	3000	Green (RoHS & no Sb/Br)	CU NIPDAU	Level-1-260C-UNLIM
LMV358IDDURG4	ACTIVE	VSSOP	DDU	8	3000	Green (RoHS & no Sb/Br)	CU NIPDAU	Level-1-260C-UNLIM
LMV358IDE4	ACTIVE	SOIC	D	8	75	Green (RoHS & no Sb/Br)	CU NIPDAU	Level-1-260C-UNLIM
LMV358IDG4	ACTIVE	SOIC	D	8	75	Green (RoHS & no Sb/Br)	CU NIPDAU	Level-1-260C-UNLIM
LMV358IDGKR	ACTIVE	MSOP	DGK	8	2500	Green (RoHS & no Sb/Br)	CU NIPDAU	Level-1-260C-UNLIM
LMV358IDGKRG4	ACTIVE	MSOP	DGK	8	2500	Green (RoHS & no Sb/Br)	CU NIPDAU	Level-1-260C-UNLIM
LMV358IDR	ACTIVE	SOIC	D	8	2500	Green (RoHS & no Sb/Br)	CU NIPDAU	Level-1-260C-UNLIM
LMV358IDRE4	ACTIVE	SOIC	D	8	2500	Green (RoHS & no Sb/Br)	CU NIPDAU	Level-1-260C-UNLIM
LMV358IDRG4	ACTIVE	SOIC	D	8	2500	Green (RoHS & no Sb/Br)	CU NIPDAU	Level-1-260C-UNLIM
LMV358IDRG4Q1	ACTIVE	SOIC	D	8	2500	Green (RoHS & no Sb/Br)	CU NIPDAU	Level-1-260C-UNLIM
LMV358IPW	ACTIVE	TSSOP	PW	8	150	Green (RoHS & no Sb/Br)	CU NIPDAU	Level-1-260C-UNLIM
LMV358IPWE4	ACTIVE	TSSOP	PW	8	150	Green (RoHS & no Sb/Br)	CU NIPDAU	Level-1-260C-UNLIM
LMV358IPWG4	ACTIVE	TSSOP	PW	8	150	Green (RoHS & no Sb/Br)	CU NIPDAU	Level-1-260C-UNLIM
LMV358IPWR	ACTIVE	TSSOP	PW	8	2000	Green (RoHS & no Sb/Br)	CU NIPDAU	Level-1-260C-UNLIM

Orderable Device	Status ⁽¹⁾	Package Type	Package Drawing	Pins	Package Qty	Eco Plan ⁽²⁾	Lead/Ball Finish	MSL Peak Temp ⁽³⁾
LMV358IPWRE4	ACTIVE	TSSOP	PW	8	2000	Green (RoHS & no Sb/Br)	CU NIPDAU	Level-1-260C-UNLIM
LMV358IPWRG4	ACTIVE	TSSOP	PW	8	2000	Green (RoHS & no Sb/Br)	CU NIPDAU	Level-1-260C-UNLIM
LMV358QD	ACTIVE	SOIC	D	8	75	Green (RoHS & no Sb/Br)	CU NIPDAU	Level-1-260C-UNLIM
LMV358QDDUR	ACTIVE	VSSOP	DDU	8	3000	Green (RoHS & no Sb/Br)	CU NIPDAU	Level-1-260C-UNLIM
LMV358QDDURE4	ACTIVE	VSSOP	DDU	8	3000	Green (RoHS & no Sb/Br)	CU NIPDAU	Level-1-260C-UNLIM
LMV358QDDURG4	ACTIVE	VSSOP	DDU	8	3000	Green (RoHS & no Sb/Br)	CU NIPDAU	Level-1-260C-UNLIM
LMV358QDE4	ACTIVE	SOIC	D	8	75	Green (RoHS & no Sb/Br)	CU NIPDAU	Level-1-260C-UNLIM
LMV358QDG4	ACTIVE	SOIC	D	8	75	Green (RoHS & no Sb/Br)	CU NIPDAU	Level-1-260C-UNLIM
LMV358QDGKR	ACTIVE	MSOP	DGK	8	2500	Green (RoHS & no Sb/Br)	CU NIPDAU	Level-1-260C-UNLIM
LMV358QDGKRG4	ACTIVE	MSOP	DGK	8	2500	Green (RoHS & no Sb/Br)	CU NIPDAU	Level-1-260C-UNLIM
LMV358QDR	ACTIVE	SOIC	D	8	2500	Green (RoHS & no Sb/Br)	CU NIPDAU	Level-1-260C-UNLIM
LMV358QDRE4	ACTIVE	SOIC	D	8	2500	Green (RoHS & no Sb/Br)	CU NIPDAU	Level-1-260C-UNLIM
LMV358QDRG4	ACTIVE	SOIC	D	8	2500	Green (RoHS & no Sb/Br)	CU NIPDAU	Level-1-260C-UNLIM
LMV358QDRG4Q1	ACTIVE	SOIC	D	8	2500	Green (RoHS & no Sb/Br)	CU NIPDAU	Level-1-260C-UNLIM
LMV358QPW	ACTIVE	TSSOP	PW	8	150	Green (RoHS & no Sb/Br)	CU NIPDAU	Level-1-260C-UNLIM
LMV358QPWE4	ACTIVE	TSSOP	PW	8	150	Green (RoHS & no Sb/Br)	CU NIPDAU	Level-1-260C-UNLIM
LMV358QPWG4	ACTIVE	TSSOP	PW	8	150	Green (RoHS & no Sb/Br)	CU NIPDAU	Level-1-260C-UNLIM
LMV358QPWR	ACTIVE	TSSOP	PW	8	2000	Green (RoHS & no Sb/Br)	CU NIPDAU	Level-1-260C-UNLIM
LMV358QPWRE4	ACTIVE	TSSOP	PW	8	2000	Green (RoHS & no Sb/Br)	CU NIPDAU	Level-1-260C-UNLIM
LMV358QPWRG4	ACTIVE	TSSOP	PW	8	2000	Green (RoHS & no Sb/Br)	CU NIPDAU	Level-1-260C-UNLIM

⁽¹⁾ The marketing status values are defined as follows:

ACTIVE: Product device recommended for new designs.

LIFEBUY: TI has announced that the device will be discontinued, and a lifetime-buy period is in effect.

NRND: Not recommended for new designs. Device is in production to support existing customers, but TI does not recommend using this part in a new design.

PREVIEW: Device has been announced but is not in production. Samples may or may not be available.

OBSOLETE: TI has discontinued the production of the device.

⁽²⁾ Eco Plan - The planned eco-friendly classification: Pb-Free (RoHS), Pb-Free (RoHS Exempt), or Green (RoHS & no Sb/Br) - please check <http://www.ti.com/productcontent> for the latest availability information and additional product content details.

TBD: The Pb-Free/Green conversion plan has not been defined.

Pb-Free (RoHS): TI's terms "Lead-Free" or "Pb-Free" mean semiconductor products that are compatible with the current RoHS requirements for all 6 substances, including the requirement that lead not exceed 0.1% by weight in homogeneous materials. Where designed to be soldered

at high temperatures, TI Pb-Free products are suitable for use in specified lead-free processes.

Pb-Free (RoHS Exempt): This component has a RoHS exemption for either 1) lead-based flip-chip solder bumps used between the die and package, or 2) lead-based die adhesive used between the die and leadframe. The component is otherwise considered Pb-Free (RoHS compatible) as defined above.

Green (RoHS & no Sb/Br): TI defines "Green" to mean Pb-Free (RoHS compatible), and free of Bromine (Br) and Antimony (Sb) based flame retardants (Br or Sb do not exceed 0.1% by weight in homogeneous material)

⁽³⁾ MSL, Peak Temp. -- The Moisture Sensitivity Level rating according to the JEDEC industry standard classifications, and peak solder temperature.

Important Information and Disclaimer:The information provided on this page represents TI's knowledge and belief as of the date that it is provided. TI bases its knowledge and belief on information provided by third parties, and makes no representation or warranty as to the accuracy of such information. Efforts are underway to better integrate information from third parties. TI has taken and continues to take reasonable steps to provide representative and accurate information but may not have conducted destructive testing or chemical analysis on incoming materials and chemicals. TI and TI suppliers consider certain information to be proprietary, and thus CAS numbers and other limited information may not be available for release.

In no event shall TI's liability arising out of such information exceed the total purchase price of the TI part(s) at issue in this document sold by TI to Customer on an annual basis.

TAPE AND REEL INFORMATION



QUADRANT ASSIGNMENTS FOR PIN 1 ORIENTATION IN TAPE



*All dimensions are nominal

Device	Package Type	Package Drawing	Pins	SPQ	Reel Diameter (mm)	Reel Width W1 (mm)	A0 (mm)	B0 (mm)	K0 (mm)	P1 (mm)	W (mm)	Pin1 Quadrant
LMV321IDBVR	SOT-23	DBV	5	3000	180.0	9.2	3.23	3.17	1.37	4.0	8.0	Q3
LMV321IDBVT	SOT-23	DBV	5	250	180.0	9.2	3.23	3.17	1.37	4.0	8.0	Q3
LMV321IDCKR	SC70	DCK	5	3000	180.0	9.2	2.24	2.34	1.22	4.0	8.0	Q3
LMV321IDCKR	SC70	DCK	5	3000	178.0	9.0	2.4	2.5	1.2	4.0	8.0	Q3
LMV321IDCKT	SC70	DCK	5	250	178.0	9.0	2.4	2.5	1.2	4.0	8.0	Q3
LMV321IDCKT	SC70	DCK	5	250	180.0	9.2	2.24	2.34	1.22	4.0	8.0	Q3
LMV324IDR	SOIC	D	14	2500	330.0	16.4	6.5	9.0	2.1	8.0	16.0	Q1
LMV324IPWR	TSSOP	PW	14	2000	330.0	12.4	7.0	5.6	1.6	8.0	12.0	Q1
LMV324QDR	SOIC	D	14	2500	330.0	16.4	6.5	9.0	2.1	8.0	16.0	Q1
LMV324QPWR	TSSOP	PW	14	2000	330.0	12.4	7.0	5.6	1.6	8.0	12.0	Q1
LMV324SIDR	SOIC	D	16	2500	330.0	16.4	6.5	10.3	2.1	8.0	16.0	Q1
LMV324SIPWR	TSSOP	PW	16	2000	330.0	12.4	7.0	5.6	1.6	8.0	12.0	Q1
LMV358IDDUR	VSSOP	DDU	8	3000	180.0	9.2	2.25	3.35	1.05	4.0	8.0	Q3
LMV358IDGKR	MSOP	DGK	8	2500	330.0	13.0	5.3	3.4	1.4	8.0	12.0	Q1
LMV358IDR	SOIC	D	8	2500	330.0	12.4	6.4	5.2	2.1	8.0	12.0	Q1
LMV358IDR	SOIC	D	8	2500	330.0	12.4	6.4	5.2	2.1	8.0	12.0	Q1
LMV358IPWR	TSSOP	PW	8	2000	330.0	12.4	7.0	3.6	1.6	8.0	12.0	Q1
LMV358QDDUR	VSSOP	DDU	8	3000	180.0	9.2	2.25	3.35	1.05	4.0	8.0	Q3

Device	Package Type	Package Drawing	Pins	SPQ	Reel Diameter (mm)	Reel Width W1 (mm)	A0 (mm)	B0 (mm)	K0 (mm)	P1 (mm)	W (mm)	Pin1 Quadrant
LMV358QDGKR	MSOP	DGK	8	2500	330.0	13.0	5.3	3.4	1.4	8.0	12.0	Q1
LMV358QDR	SOIC	D	8	2500	330.0	12.4	6.4	5.2	2.1	8.0	12.0	Q1
LMV358QPWR	TSSOP	PW	8	2000	330.0	12.4	7.0	3.6	1.6	8.0	12.0	Q1

TAPE AND REEL BOX DIMENSIONS

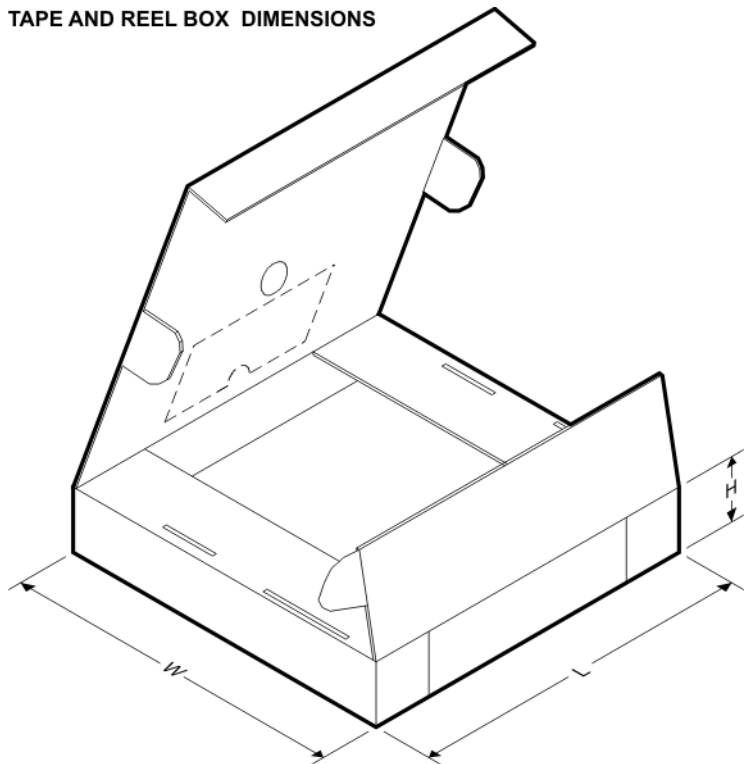

*All dimensions are nominal

Device	Package Type	Package Drawing	Pins	SPQ	Length (mm)	Width (mm)	Height (mm)
LMV321IDBVR	SOT-23	DBV	5	3000	205.0	200.0	33.0
LMV321IDBVT	SOT-23	DBV	5	250	201.0	192.0	26.0
LMV321IDCKR	SC70	DCK	5	3000	202.0	201.0	28.0
LMV321IDCKR	SC70	DCK	5	3000	180.0	180.0	18.0
LMV321IDCKT	SC70	DCK	5	250	180.0	180.0	18.0
LMV321IDCKT	SC70	DCK	5	250	202.0	201.0	28.0
LMV324IDR	SOIC	D	14	2500	346.0	346.0	33.0
LMV324IPWR	TSSOP	PW	14	2000	346.0	346.0	29.0
LMV324QDR	SOIC	D	14	2500	346.0	346.0	33.0
LMV324QPWR	TSSOP	PW	14	2000	346.0	346.0	29.0
LMV324SIDR	SOIC	D	16	2500	333.2	345.9	28.6
LMV324SIPWR	TSSOP	PW	16	2000	346.0	346.0	29.0
LMV358IDDUR	VSSOP	DDU	8	3000	202.0	201.0	28.0
LMV358IDGKR	MSOP	DGK	8	2500	358.0	335.0	35.0

Device	Package Type	Package Drawing	Pins	SPQ	Length (mm)	Width (mm)	Height (mm)
LMV358IDR	SOIC	D	8	2500	340.5	338.1	20.6
LMV358IDR	SOIC	D	8	2500	346.0	346.0	29.0
LMV358IPWR	TSSOP	PW	8	2000	346.0	346.0	29.0
LMV358QDDUR	VSSOP	DDU	8	3000	202.0	201.0	28.0
LMV358QDGKR	MSOP	DGK	8	2500	358.0	335.0	35.0
LMV358QDR	SOIC	D	8	2500	340.5	338.1	20.6
LMV358QPWR	TSSOP	PW	8	2000	346.0	346.0	29.0

DBV (R-PDSO-G5)

PLASTIC SMALL-OUTLINE PACKAGE

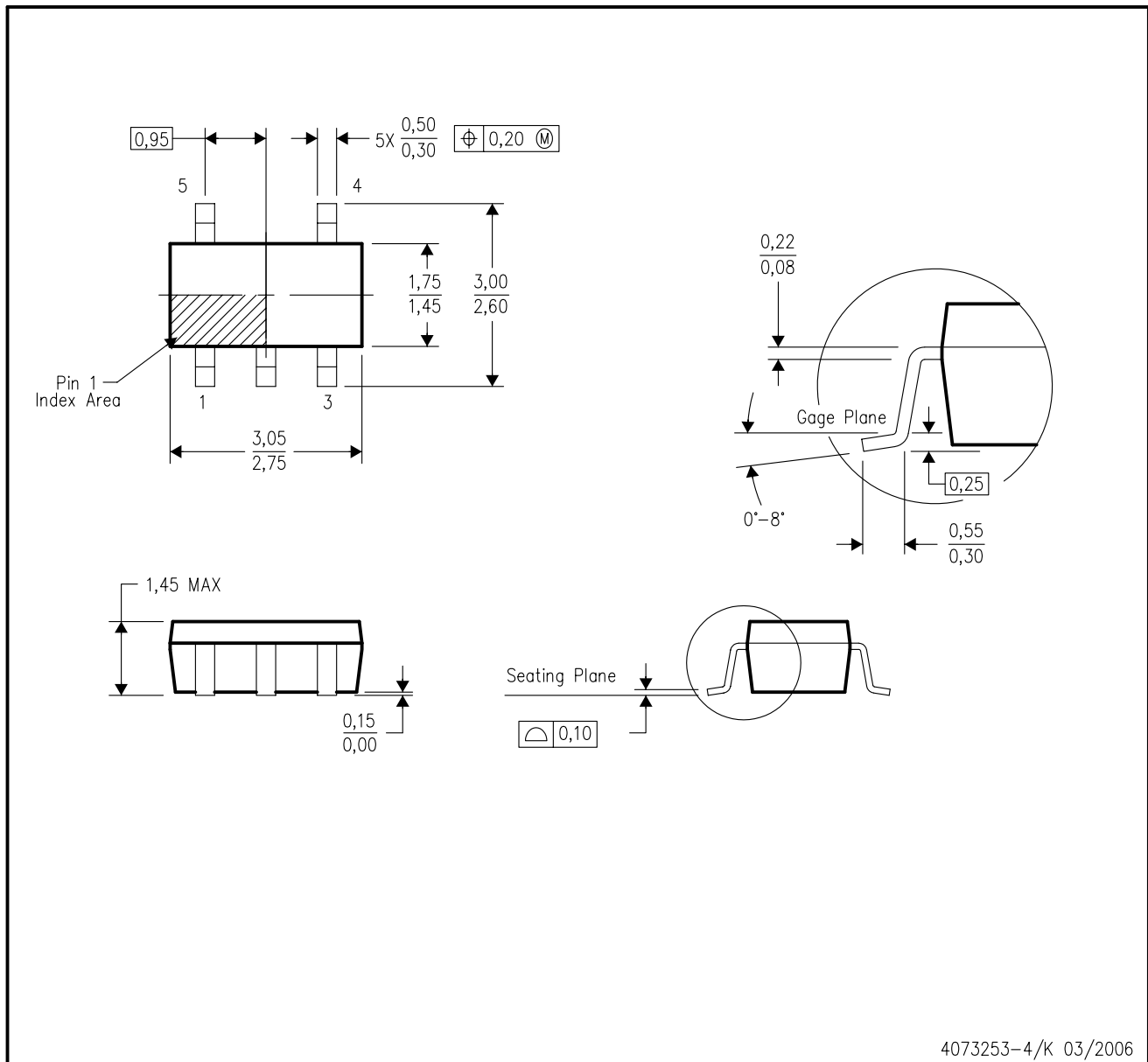

- NOTES:
- A. All linear dimensions are in millimeters.
 - B. This drawing is subject to change without notice.
 - C. Body dimensions do not include mold flash or protrusion. Mold flash and protrusion shall not exceed 0.15 per side.
 - D. Falls within JEDEC MO-178 Variation AA.

DCK (R-PDSO-G5)

PLASTIC SMALL-OUTLINE PACKAGE

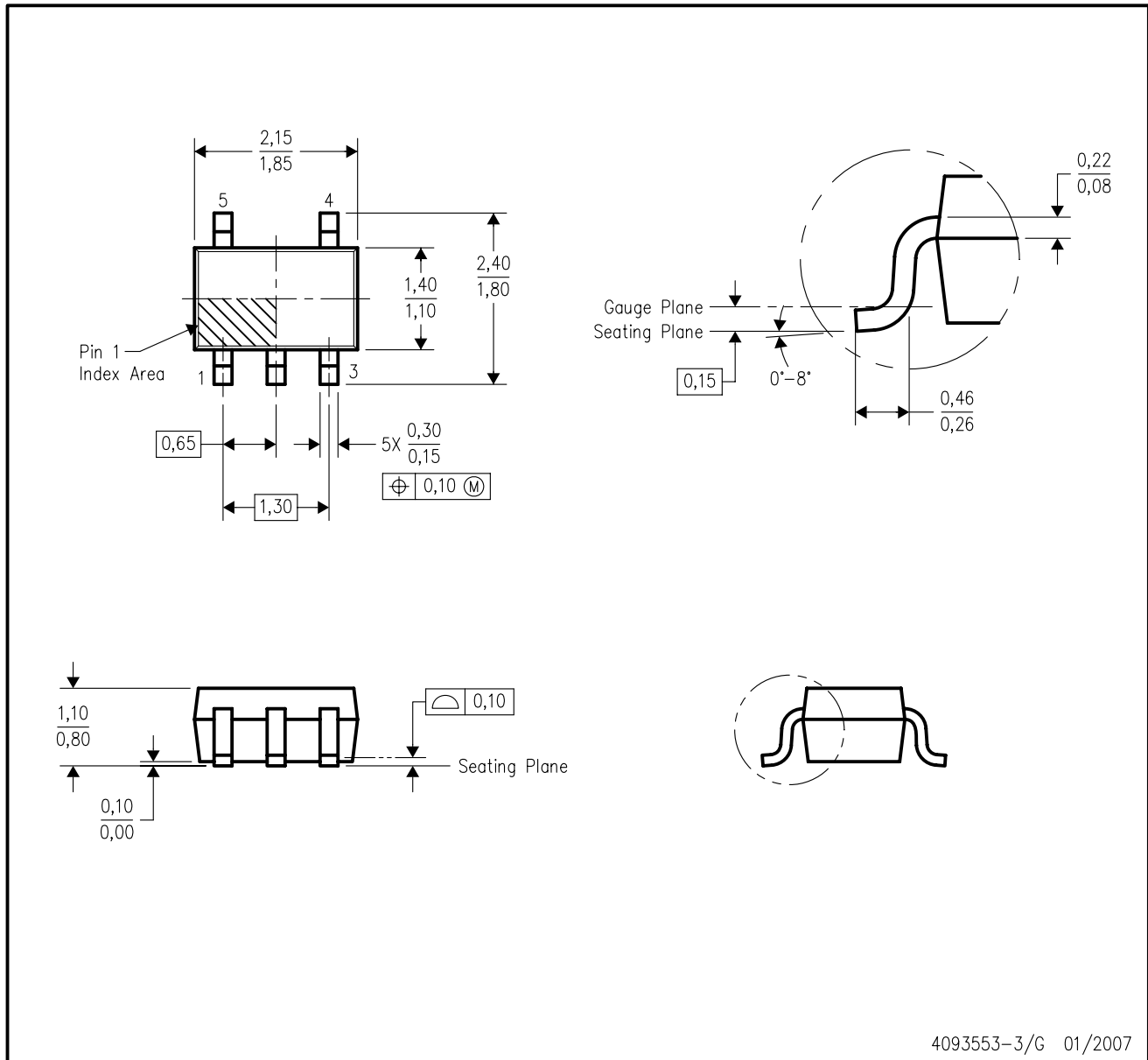

- NOTES:
- A. All linear dimensions are in millimeters.
 - B. This drawing is subject to change without notice.
 - C. Body dimensions do not include mold flash or protrusion. Mold flash and protrusion shall not exceed 0.15 per side.
 - D. Falls within JEDEC MO-203 variation AA.

PW (R-PDSO-G**)

PLASTIC SMALL-OUTLINE PACKAGE

14 PINS SHOWN



4040064/F 01/97

- NOTES: A. All linear dimensions are in millimeters.
 B. This drawing is subject to change without notice.
 C. Body dimensions do not include mold flash or protrusion not to exceed 0,15.
 D. Falls within JEDEC MO-153

D (R-PDSO-G8)

PLASTIC SMALL-OUTLINE PACKAGE

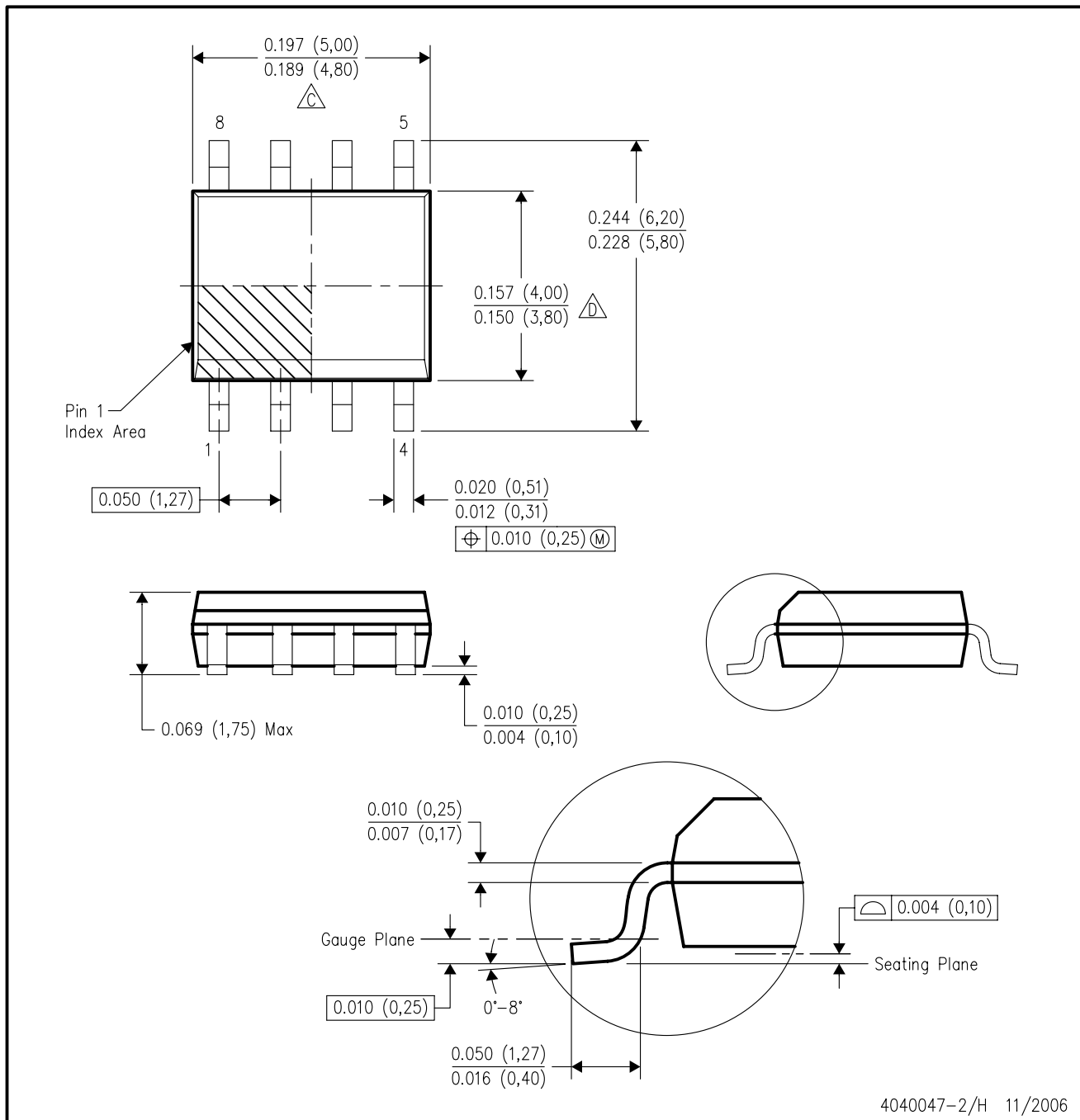

4040047-2/H 11/2006

- NOTES:
- A. All linear dimensions are in inches (millimeters).
 - B. This drawing is subject to change without notice.
 - Body length does not include mold flash, protrusions, or gate burrs. Mold flash, protrusions, or gate burrs shall not exceed .006 (0,15) per end.
 - Body width does not include interlead flash. Interlead flash shall not exceed .017 (0,43) per side.
 - E. Reference JEDEC MS-012 variation AA.

D (R-PDSO-G14)

PLASTIC SMALL-OUTLINE PACKAGE

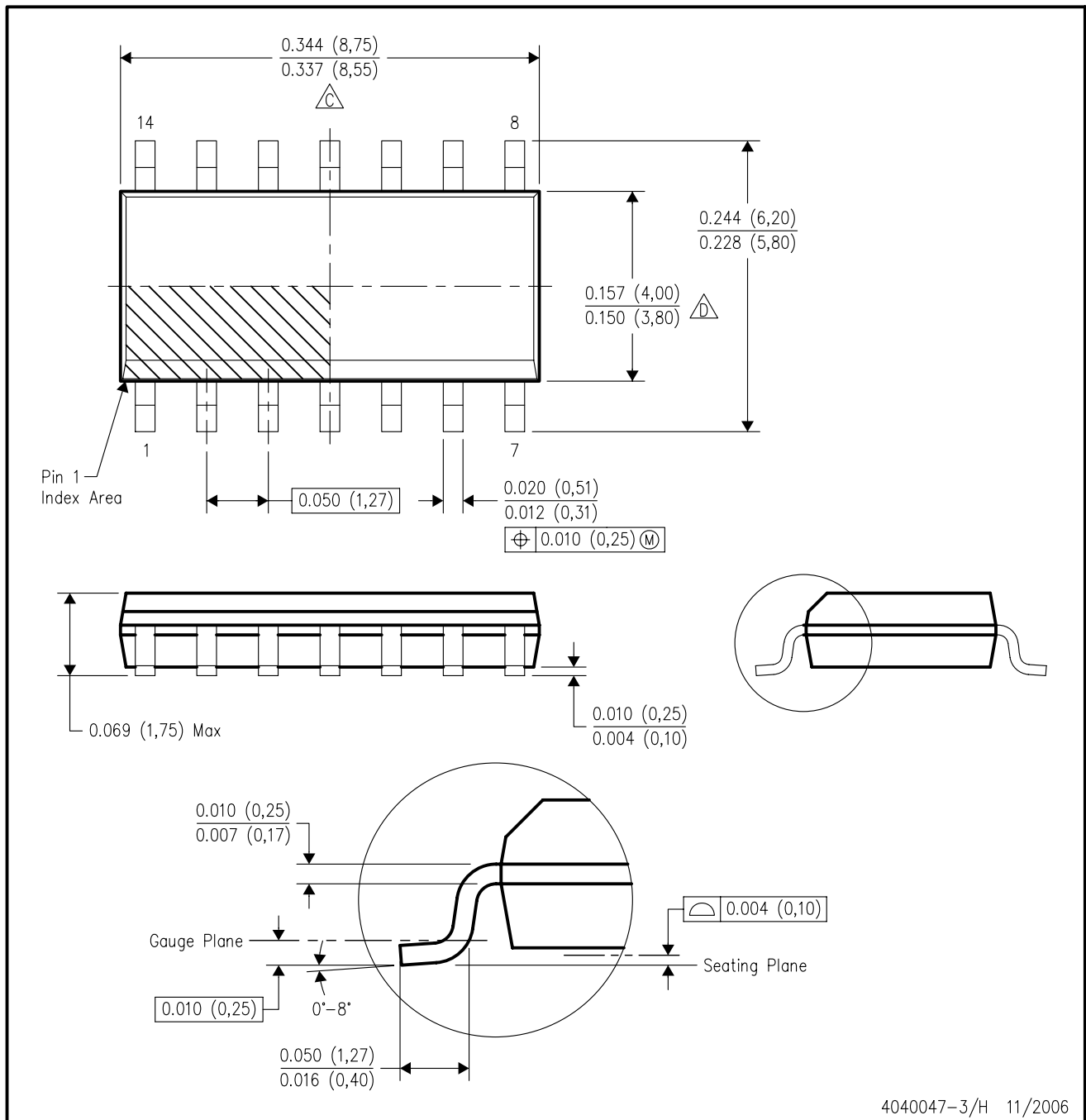

- NOTES:
- A. All linear dimensions are in inches (millimeters).
 - B. This drawing is subject to change without notice.
 - C. Body length does not include mold flash, protrusions, or gate burrs. Mold flash, protrusions, or gate burrs shall not exceed .006 (0,15) per end.
 - D. Body width does not include interlead flash. Interlead flash shall not exceed .017 (0,43) per side.
 - E. Reference JEDEC MS-012 variation AB.

DGK (S-PDSO-G8)

PLASTIC SMALL-OUTLINE PACKAGE



- NOTES:
- A. All linear dimensions are in millimeters.
 - B. This drawing is subject to change without notice.
 - C. Body length does not include mold flash, protrusions, or gate burrs. Mold flash, protrusions, or gate burrs shall not exceed 0.15 per end.
 - D. Body width does not include interlead flash. Interlead flash shall not exceed 0.50 per side.
 - E. Falls within JEDEC MO-187 variation AA, except interlead flash.

D (R-PDSO-G16)

PLASTIC SMALL-OUTLINE PACKAGE

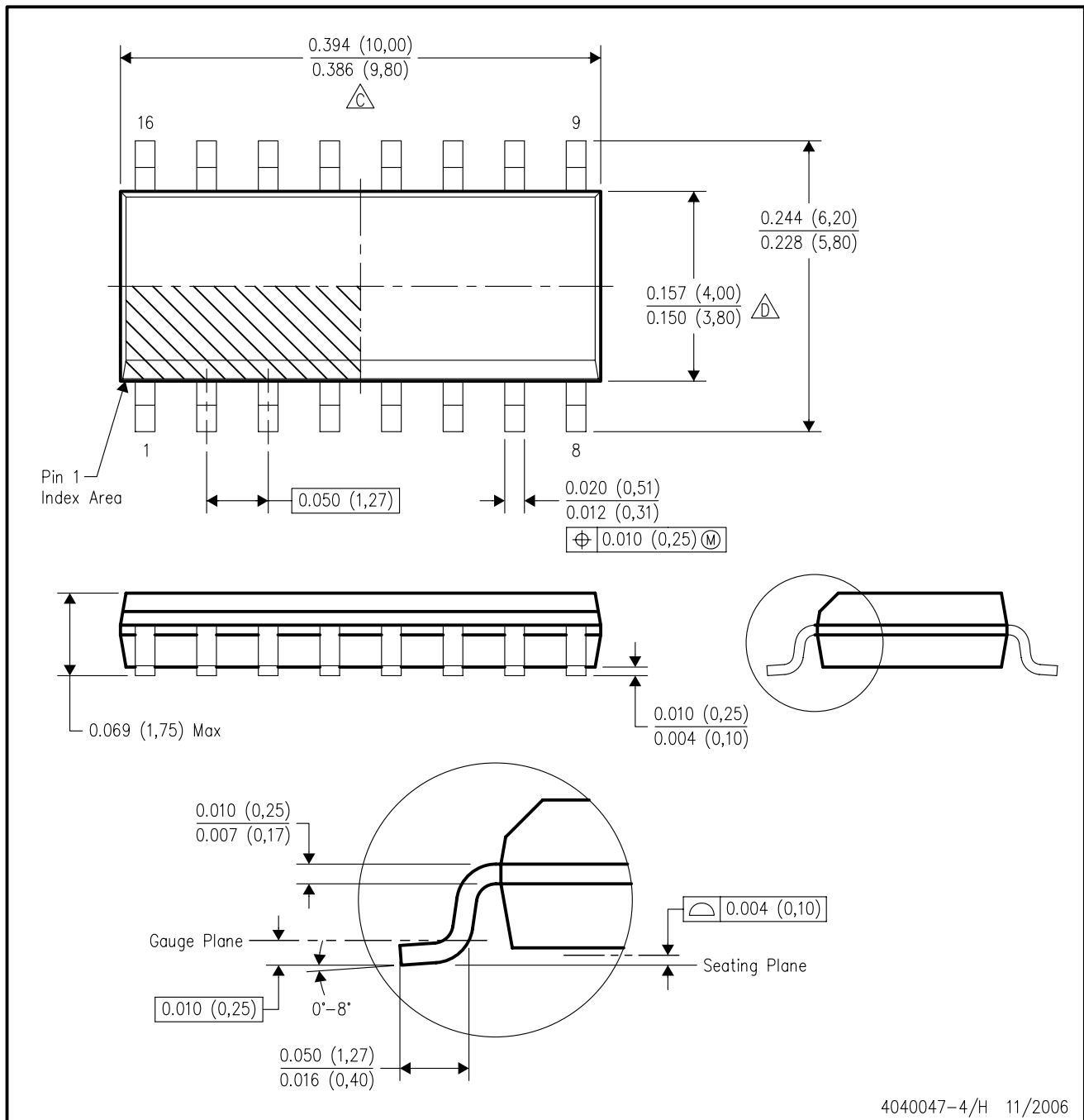

- NOTES:
- A. All linear dimensions are in inches (millimeters).
 - B. This drawing is subject to change without notice.
 - C. Body length does not include mold flash, protrusions, or gate burrs. Mold flash, protrusions, or gate burrs shall not exceed .006 (0,15) per end.
 - D. Body width does not include interlead flash. Interlead flash shall not exceed .017 (0,43) per side.
 - E. Reference JEDEC MS-012 variation AC.

IMPORTANT NOTICE

Texas Instruments Incorporated and its subsidiaries (TI) reserve the right to make corrections, modifications, enhancements, improvements, and other changes to its products and services at any time and to discontinue any product or service without notice. Customers should obtain the latest relevant information before placing orders and should verify that such information is current and complete. All products are sold subject to TI's terms and conditions of sale supplied at the time of order acknowledgment.

TI warrants performance of its hardware products to the specifications applicable at the time of sale in accordance with TI's standard warranty. Testing and other quality control techniques are used to the extent TI deems necessary to support this warranty. Except where mandated by government requirements, testing of all parameters of each product is not necessarily performed.

TI assumes no liability for applications assistance or customer product design. Customers are responsible for their products and applications using TI components. To minimize the risks associated with customer products and applications, customers should provide adequate design and operating safeguards.

TI does not warrant or represent that any license, either express or implied, is granted under any TI patent right, copyright, mask work right, or other TI intellectual property right relating to any combination, machine, or process in which TI products or services are used. Information published by TI regarding third-party products or services does not constitute a license from TI to use such products or services or a warranty or endorsement thereof. Use of such information may require a license from a third party under the patents or other intellectual property of the third party, or a license from TI under the patents or other intellectual property of TI.

Reproduction of TI information in TI data books or data sheets is permissible only if reproduction is without alteration and is accompanied by all associated warranties, conditions, limitations, and notices. Reproduction of this information with alteration is an unfair and deceptive business practice. TI is not responsible or liable for such altered documentation. Information of third parties may be subject to additional restrictions.

Resale of TI products or services with statements different from or beyond the parameters stated by TI for that product or service voids all express and any implied warranties for the associated TI product or service and is an unfair and deceptive business practice. TI is not responsible or liable for any such statements.

TI products are not authorized for use in safety-critical applications (such as life support) where a failure of the TI product would reasonably be expected to cause severe personal injury or death, unless officers of the parties have executed an agreement specifically governing such use. Buyers represent that they have all necessary expertise in the safety and regulatory ramifications of their applications, and acknowledge and agree that they are solely responsible for all legal, regulatory and safety-related requirements concerning their products and any use of TI products in such safety-critical applications, notwithstanding any applications-related information or support that may be provided by TI. Further, Buyers must fully indemnify TI and its representatives against any damages arising out of the use of TI products in such safety-critical applications.

TI products are neither designed nor intended for use in military/aerospace applications or environments unless the TI products are specifically designated by TI as military-grade or "enhanced plastic." Only products designated by TI as military-grade meet military specifications. Buyers acknowledge and agree that any such use of TI products which TI has not designated as military-grade is solely at the Buyer's risk, and that they are solely responsible for compliance with all legal and regulatory requirements in connection with such use.

TI products are neither designed nor intended for use in automotive applications or environments unless the specific TI products are designated by TI as compliant with ISO/TS 16949 requirements. Buyers acknowledge and agree that, if they use any non-designated products in automotive applications, TI will not be responsible for any failure to meet such requirements.

Following are URLs where you can obtain information on other Texas Instruments products and application solutions:

Products

Amplifiers	amplifier.ti.com
Data Converters	dataconverter.ti.com
DSP	dsp.ti.com
Clocks and Timers	www.ti.com/clocks
Interface	interface.ti.com
Logic	logic.ti.com
Power Mgmt	power.ti.com
Microcontrollers	microcontroller.ti.com
RFID	www.ti-rfid.com
RF/IF and ZigBee® Solutions	www.ti.com/lprf

Applications

Audio	www.ti.com/audio
Automotive	www.ti.com/automotive
Broadband	www.ti.com/broadband
Digital Control	www.ti.com/digitalcontrol
Medical	www.ti.com/medical
Military	www.ti.com/military
Optical Networking	www.ti.com/opticalnetwork
Security	www.ti.com/security
Telephony	www.ti.com/telephony
Video & Imaging	www.ti.com/video
Wireless	www.ti.com/wireless

Mailing Address: Texas Instruments, Post Office Box 655303, Dallas, Texas 75265
Copyright © 2008, Texas Instruments Incorporated