

# **TINA**

## **Design Suite**

### **Advanced Topics Manual**

**DesignSoft**

[www.designsoftware.com](http://www.designsoftware.com)

## **COPYRIGHTS**

© *Copyright 1990-2018 DesignSoft, Inc.* All rights reserved.

All programs recorded on the original release CD of *TINA* and the accompanying documentation are copyrighted. *TINA* is provided under a License Agreement and may be used or copied only in accordance with its terms and conditions.

## **LIMITED LIABILITY**

*TINA*, together with all accompanying materials, is provided on an “as is” basis, without warranty of any kind.

DesignSoft, Inc., its distributors, and dealers make no warranty, either expressed, implied, or statutory, including but not limited to any implied warranties of merchantability or fitness for any purpose.

In no event will DesignSoft Inc., its distributor or dealer be liable to anyone for direct, indirect, incidental or consequential damages or losses arising from the purchase of *TINA* or from use or inability to use *TINA*.

## **TRADEMARKS**

*IBM PC/AT, PS/2* are registered trademarks of *International Business Machines Corporation*

*Windows, Windows 9x/ME/NT/2000/ Vista / Windows 7* are trademarks of *Microsoft Corporation*

*PSpice* is a registered trademark of *MicroSim Corporation*

*Corel Draw* is a registered trademark of *Corel Inc.*

*TINA* is a registered trademark of *DesignSoft, Inc.*

# Table of Contents

Tina Advanced Topics.....	3
Parameter Stepping.....	4
DC Transfer Characteristic and parameter sweeping .....	20
Phasor Diagram .....	26
Nyquist Diagram .....	29
Noise Analysis.....	31
Small signal AC Noise Analysis.....	31
Transient Noise Analysis .....	36
Network Analysis and S-parameters.....	39
Symbolic Analysis.....	45
Post-processing Analysis Results.....	56
Design Tool .....	67
Optimization .....	72
Design Tool vs. Optimization .....	80
Fourier Analysis .....	81
Using IBIS models in TINA.....	105

# TINA ADVANCED TOPICS

## Introduction

TINA offers many useful and advanced features for designing, testing, and teaching electronics. These include S-parameter models, network analysis, Fourier series and Fourier spectrum analysis, noise analysis, symbolic analysis, post-processing of analysis results, phasor diagrams, Nyquist diagrams, a built-in interpreter, multi-parameter optimization, and much more.

Detailed descriptions of all these features can be found in this electronic manual.

- Parameter Stepping
- DC Transfer Characteristic and Parameter Sweeping
- Phasor Diagram
- Nyquist Diagram
- Noise Analysis
- Network Analysis and S-parameters
- Symbolic Analysis
- Post-processing Analysis Results
- Design Tool
- Optimization
- Design Tool vs. Optimization
- Fourier Series and Fourier Spectrum
- Using IBIS models in TINA

We are continuously adding new topics and examples to this chapter, so please check back regularly to the Documentation section of our web site **[www.tina.com](http://www.tina.com)** for the latest version.

# Parameter Stepping

In parameter stepping mode, TINA steps the associated component values a given number of times through a given range and runs the selected analysis for each value. This results in the calculation and plotting of a set of curves illustrating the sensitivity of the circuit to changes in the associated parameters.

Parameter Stepping is controlled by four parameters: Start value, End value, Number of cases, and Sweep type (Linear, Logarithmic or List).

The stepped component value parameters can be any numerical parameters of the TINA components—e.g., the resistance of resistors, the setting of a potentiometer, or parameters on transistor data sheets.

To set up parameter stepping for a component, click on the Analysis.Control Object menu item, or click on the  Select Control Object speed button.

A cursor that looks like a resistor will appear in the schematic editor window, waiting for you to identify the component for which you wish to assign a stepped parameter. Point at the desired component, right click, and all of its associated parameters will be displayed in the dialog window.

Should the desired parameter belong to a catalog component or be an excitation attribute, you must first select the semiconductor or waveform type so that you can access the appropriate data sheet.

In the case of a resistor, for example, the following dialog window will appear:

## Parameter Stepping

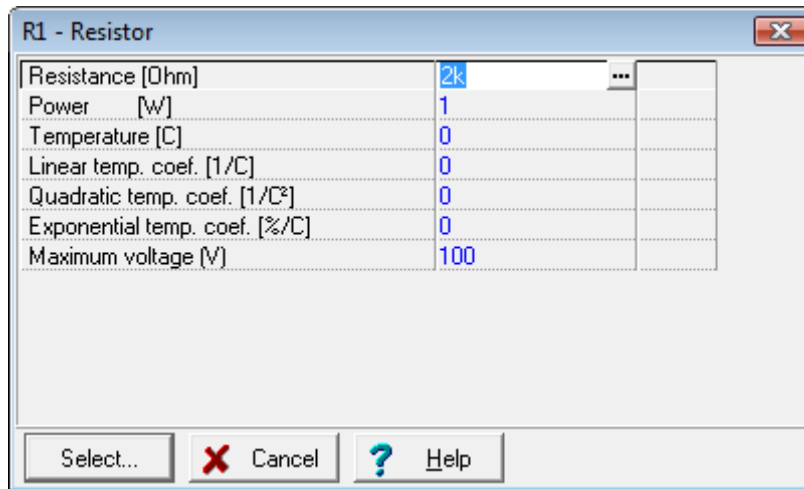

Select the line containing the parameter to be stepped and then click on the Select button. The following dialog will appear:

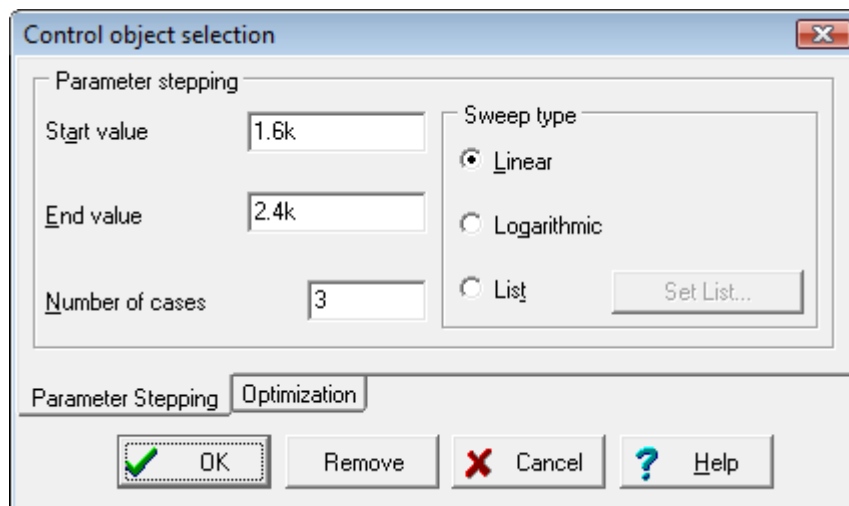

Set the appropriate stepping parameters. The number of cases includes the Start and End values.

By setting the number of steps to 1, you can perform a single analysis at the value defined by the Start value of the parameter. This gives you a way of examining the response with only a temporary change of parameter (without modifying the original value).

If you press the List button and then press the unlabeled button to the right, the List Editor for parameter stepping will appear:

## Parameter Stepping

---

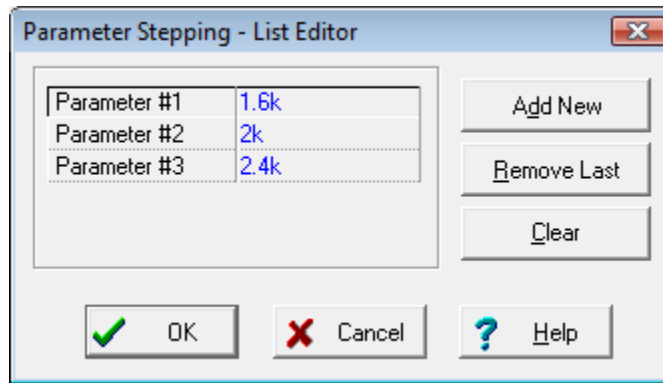

By default it will show three values calculated between the Start and End value, but you can enter any values you wish, remove values, or clear the list entirely.

Press OK to return to the previous dialog window which, in turn can be closed by its OK button. You can also turn off parameter stepping for this component using the Remove button.

You can repeat the above procedure for any number of parameters to be stepped.

*Note that you do not have to use the same number of cases for each value being stepped. TINA will run an analysis for all possible combinations of values stepped. For example, if you ask to vary part A in three steps and part B in four steps, you'll get twelve curves.*

The program will go into parameter stepping mode automatically whenever a component is set as control object according to the procedure above. The mode status can be checked via the Analysis Mode Selection dialog window.

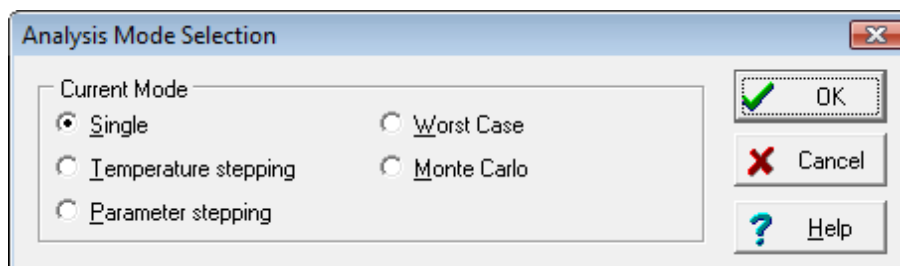

---

## Parameter Stepping

---

You can use this dialog to select single analysis or parameter stepping analysis, as well as Temperature Stepping, Worst Case and Monte Carlo analysis.

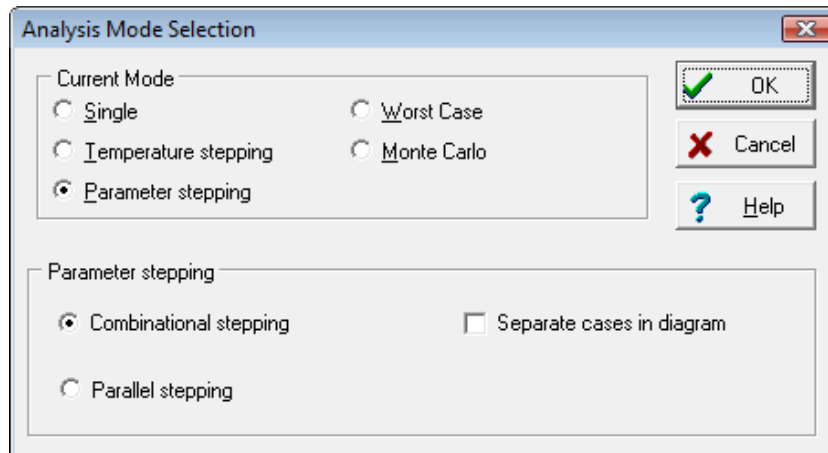

When stepping two or more parameters, TINA will use one or the other of two main modes of parameter stepping:

**Combinatorial stepping:** with combinatorial stepping, the stepped parameters can have different numbers of steps. TINA will run an analysis for all possible combinations of values stepped. For example, if you ask to vary part A in three steps and part B in four steps, the analysis will present twelve curves.

**Parallel stepping:** In this mode, the program will change all the values to be stepped simultaneously, yielding a quantity of analysis curves equal to the smallest number of values of any of the parameters being stepped. First TINA will compute the curves for the Start values for each stepped value. Next, the program will compute the curves between the Start and End values for each stepped value in isolation from each other and does not use the values from other cases in combination. We suggest when running a parallel stepping analysis that you give each parameter the same number of steps—it will keep things simpler.

*For one stepped parameter the above two modes are equivalent.*

An example of the two modes will clarify these modalities. If you ask to vary values of parts A and B, both in three steps you'll get only



## Parameter Stepping

---

3 curves with Parallel stepping and 9 curves with Combinatorial stepping.

**EXAMPLE:** Let the stepped values for R be 100, 200 & 300 Ohms, and for C be 500p, 1000p & 1500p Farads. TINA will run these cases with the following values:

**Combinatorial stepping (9 analyses)**      **Parallel stepping (3 analyses)**

R	C		R	C
100	500p		100	500p
200	500p		200	1000p
300	500p		300	1500p
100	1000p			
200	1000p			
300	1000p			
100	1500p			
200	1500p			
300	1500p			

**Separate cases in diagrams.** By default, all stepped curves are drawn in the same diagram. However, if the *Separate cases in diagrams* checkbox is checked, then each stepped curve is presented in its own diagram, with its own tab, in the Diagram Window.

Using **Separate cases in diagrams** and **Parallel stepping** makes it easy to create, run and document test benches (a suite of test circuits, each with a particular set of values that simulate devices under test).

The following examples will make Parameter Stepping clearer. Load the file RLC\_1.TSC from TINA's EXAMPLES folder. Note that this circuit is already in combinational parameter stepping mode for the resistor R, which is changed between 100  $\Omega$  and 1.1k $\Omega$  in 3 steps. Click the  button, select the R resistor with the new cursor, and press Select. You should see the following dialog window:

## Parameter Stepping

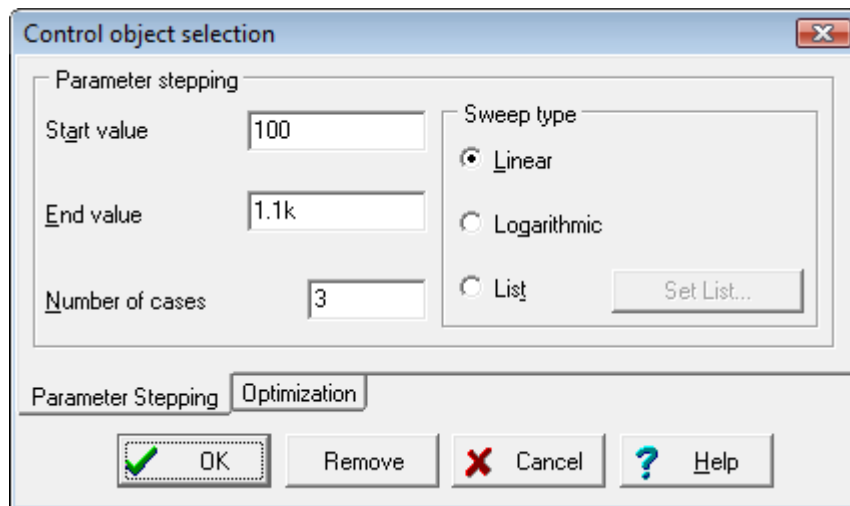

After closing this dialog and running Analysis/AC Analysis/AC Transfer Characteristic, the following diagram will appear:

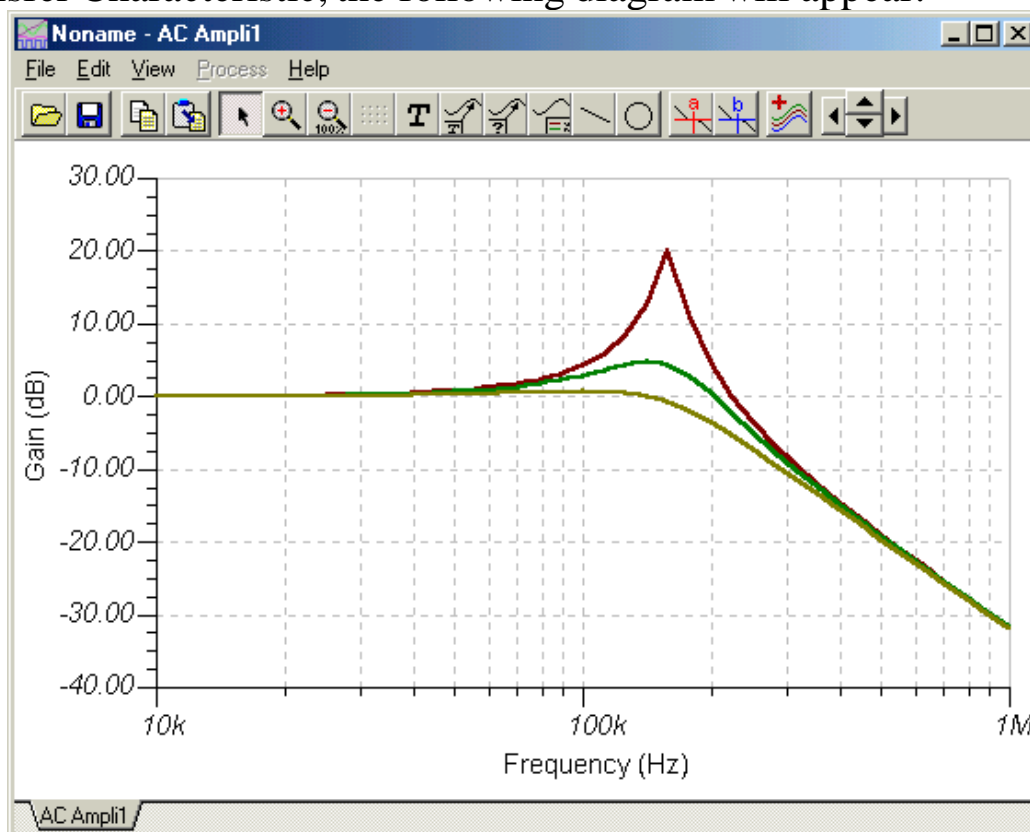

To determine which value of the stepped parameter is associated with a curve, move the cursor over the curve and read the corresponding value in the line at the bottom of the screen. You can also use the Legend and Auto label buttons in the diagram window to show the corresponding stepped values. Refer to the diagram below.

## Parameter Stepping

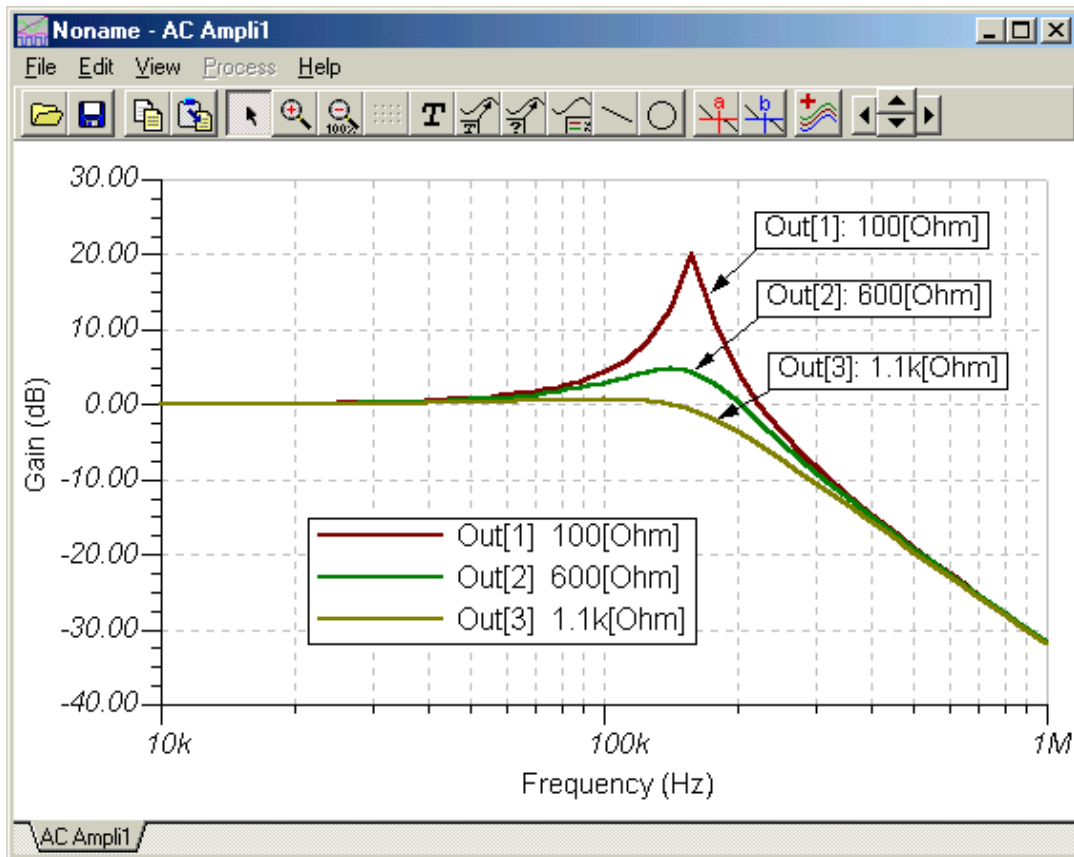

Now let's step the value of the capacitor using the List option. Let the values be 100pF and 1nF.

Click the  button, select the capacitor C, and press Select. You should see the following window:

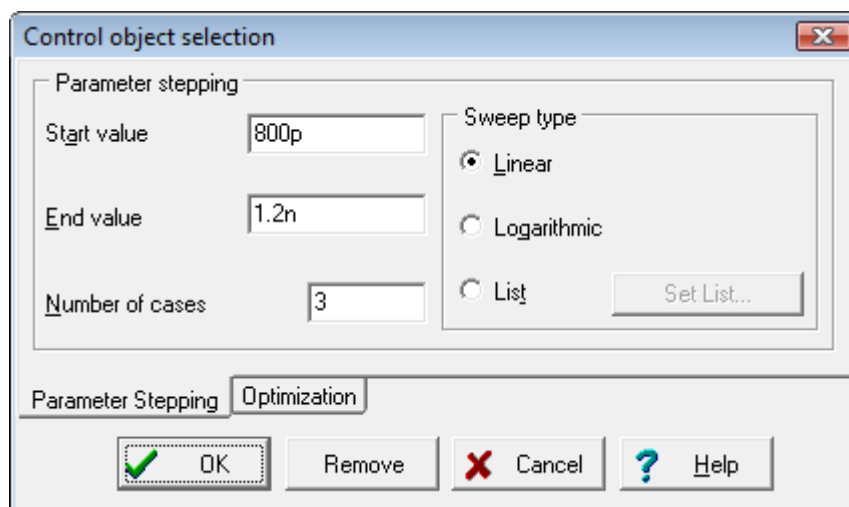

Select the List option and press the button to its right. The following dialog will appear:

## Parameter Stepping

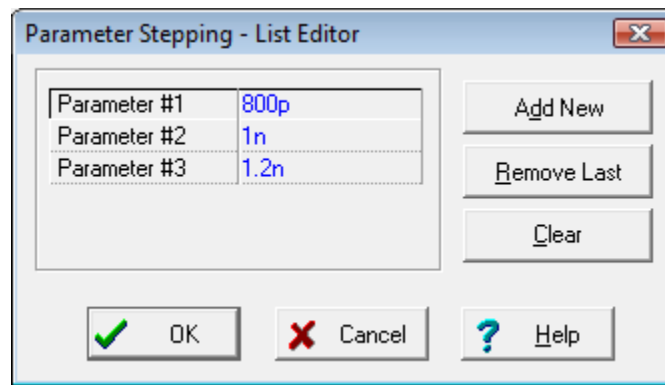

Press the Remove Last button and set the first parameter to 100p.

Now close all the dialog windows by pressing their OK buttons and run Analysis/AC Analysis/AC Transfer Characteristic.

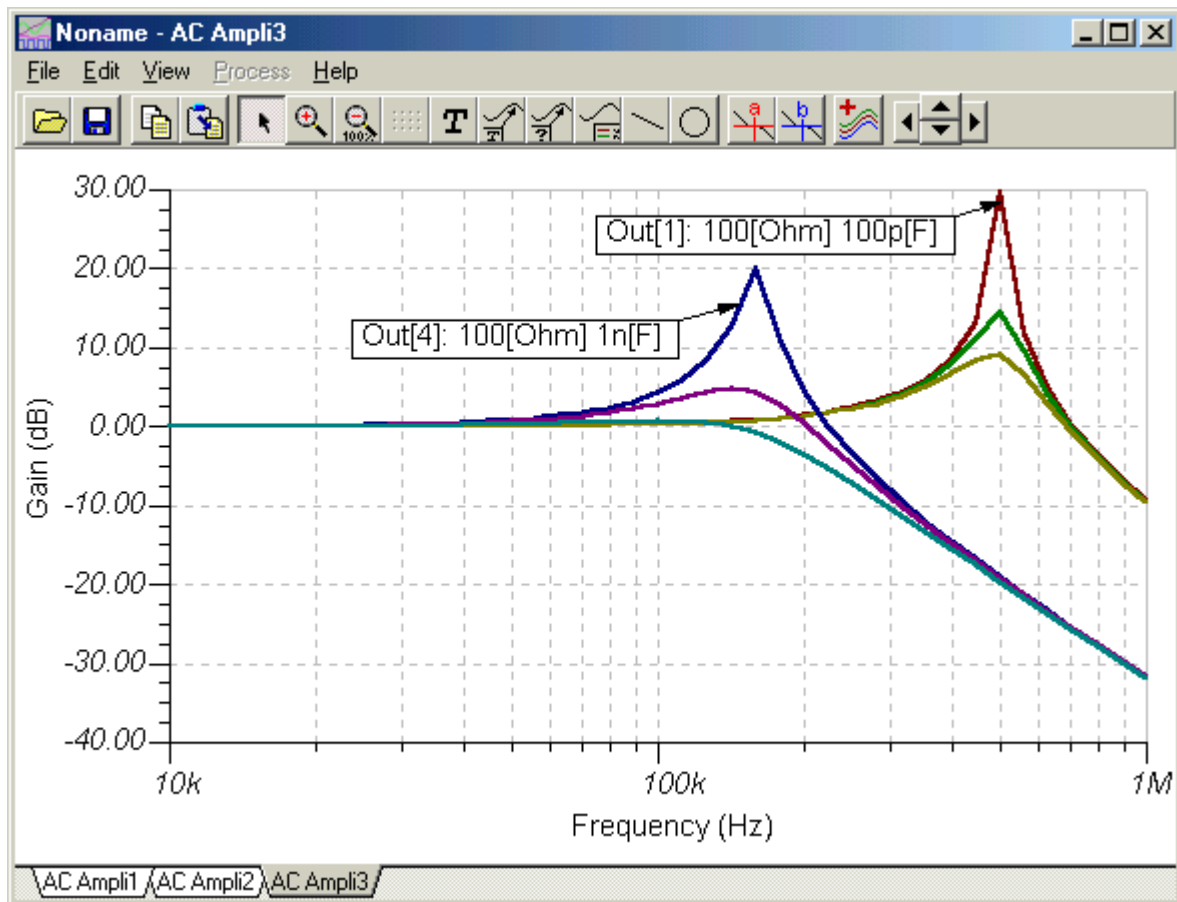

The new set of curves belonging to the cases where  $C=100\text{pF}$  can be clearly recognized on the right side of the diagram. We have also added two auto labels showing the typical values of the parameters.

## Parameter Stepping

If you have multiple curves in the diagram window you can also separate them to independent vertical axes for clearer view. Just select the "Separate curves" in the View menu and you will get the following diagram:

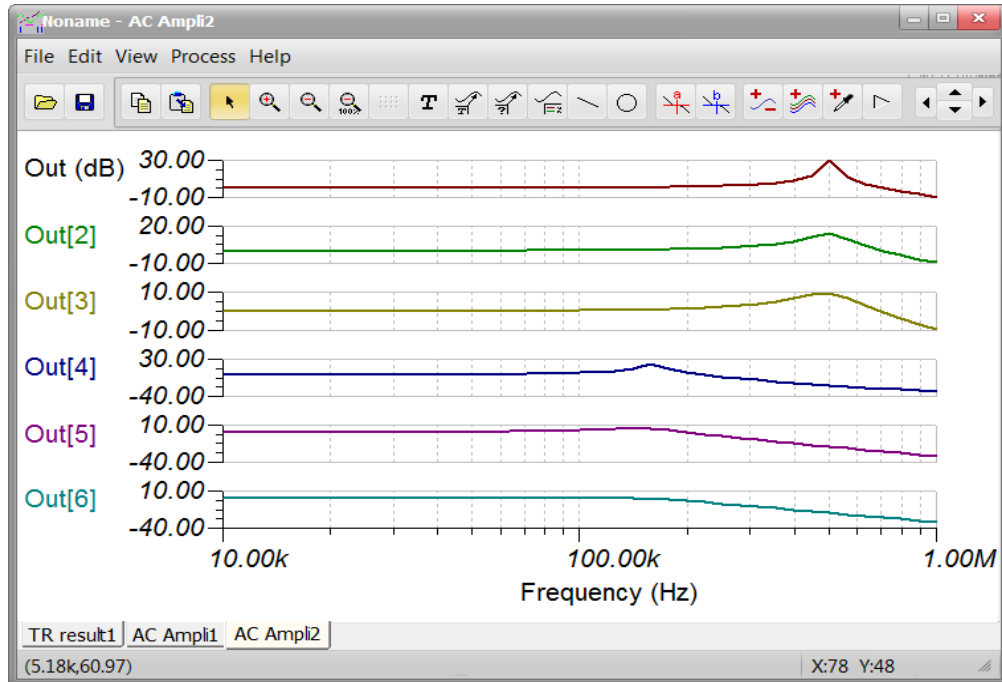

Now let's add another output -- a voltage pin -- to the circuit between the resistor and the inductor. We will call it Vrl.

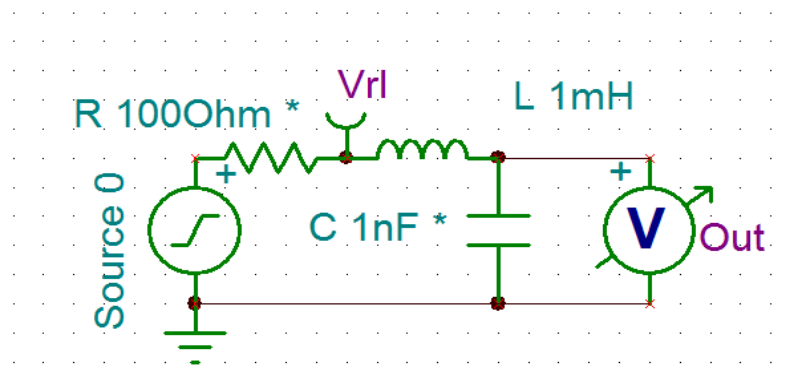

With this change AC transfer calculation will already generate 12 curves.

## Parameter Stepping

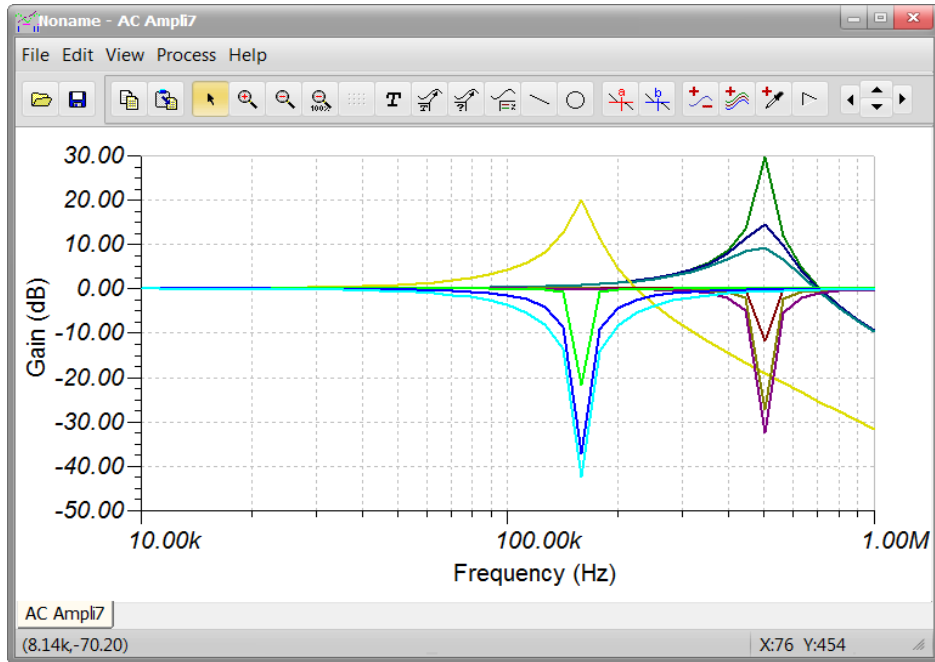

If you want to analyze the curves independently you can again use the "Separate curves" menu. However, in this case it would be much better to keep the curves belonging to the same output together. To reorganize the curves based on their output, first select "Collect curves" (if the curves are already separated) then click on "Separate Outputs" in the View menu.

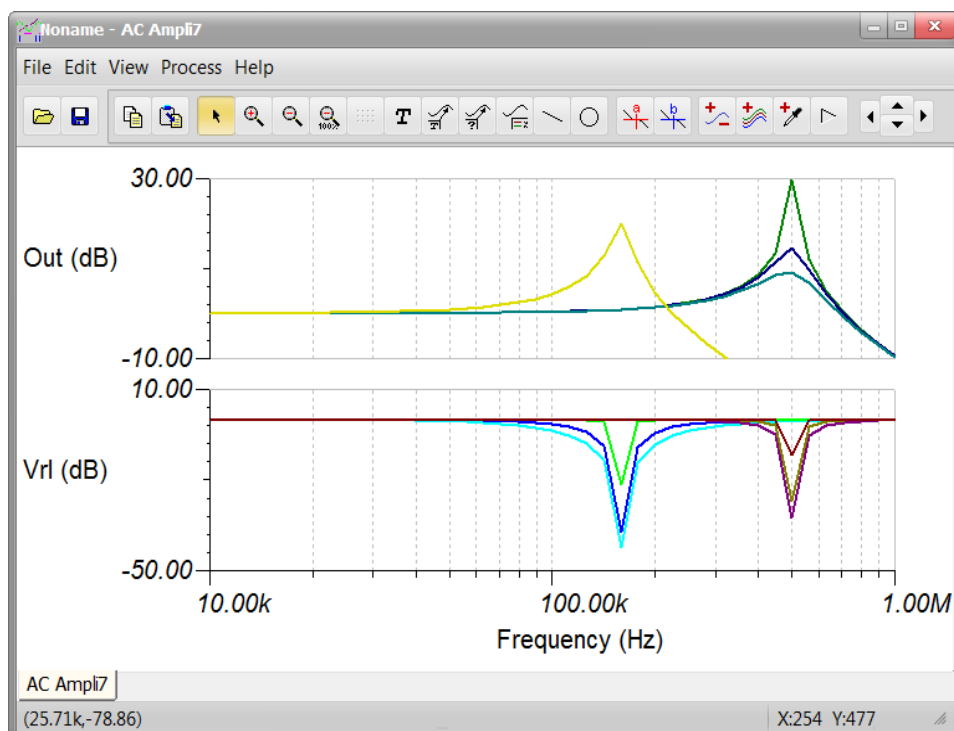

## Parameter Stepping

---

Curve separation can be also done automatically using the appropriate output labels. To automatically separate all the curves please add a colon (:) and an integer index to the output label names. E.g. renaming "Out" to "Out:1" will force the analysis to automatically separate the curves after calculation, and the index at the end of the label will be used to set the order of the curves from the top to the bottom of the diagram. If you want to separate only the outputs please use double colon (::) and an index number. E.g. "Out::1" Please also note, that you do not need to specify all the curve indexes, the curves will be separated already if one is specified. Unspecified curves will be put at the end of the curve's list on the bottom of the diagram.

## Parameter Stepping

---

To demonstrate **Parallel Stepping** open the RLC\_1 Parallel Parameter Stepping.TSC circuit from the EXAMPLES\Parameter Stepping folder of TINA. For this circuit the Analysis Mode Selection settings:

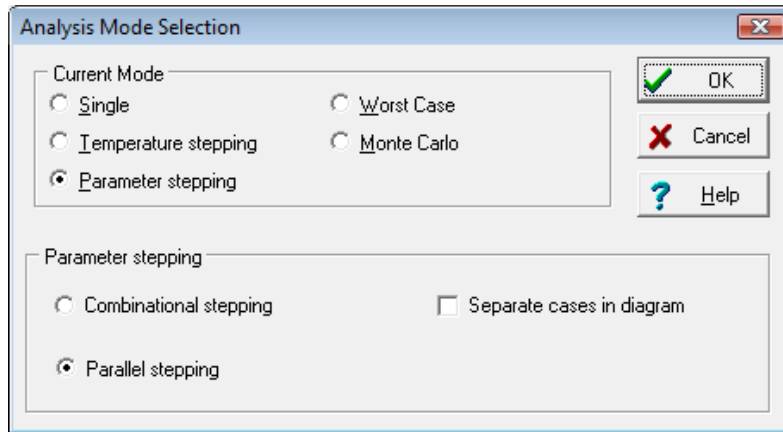

The parameter settings for R

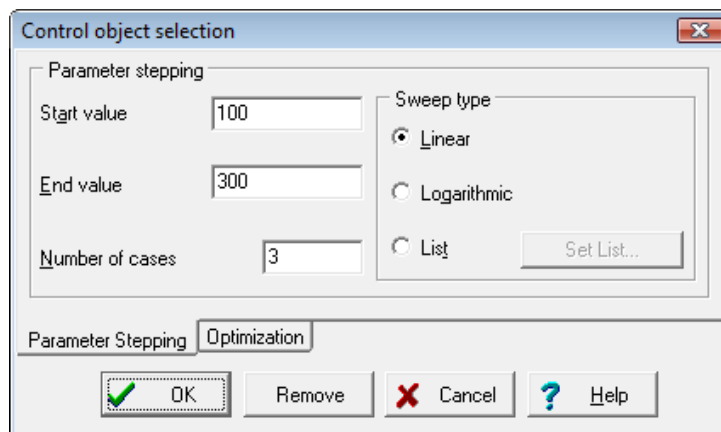

The stepped values will be: 100, 200 and 300 Ohms

The parameters setting for C:

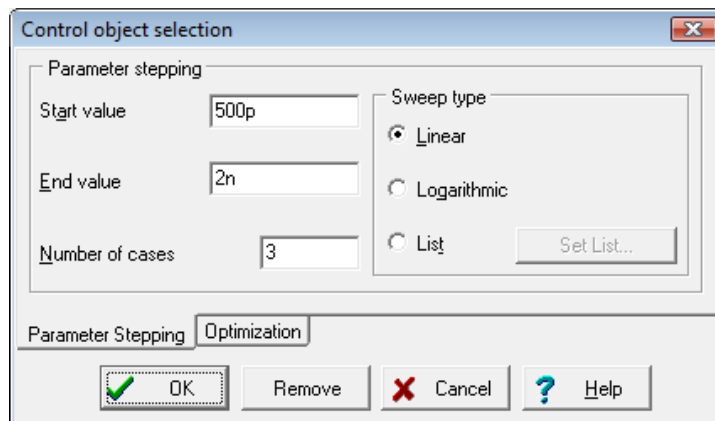



## Parameter Stepping

The stepped values will be: 500pF, 1.25nF, 2nF.

The AC Transfer Characteristics:

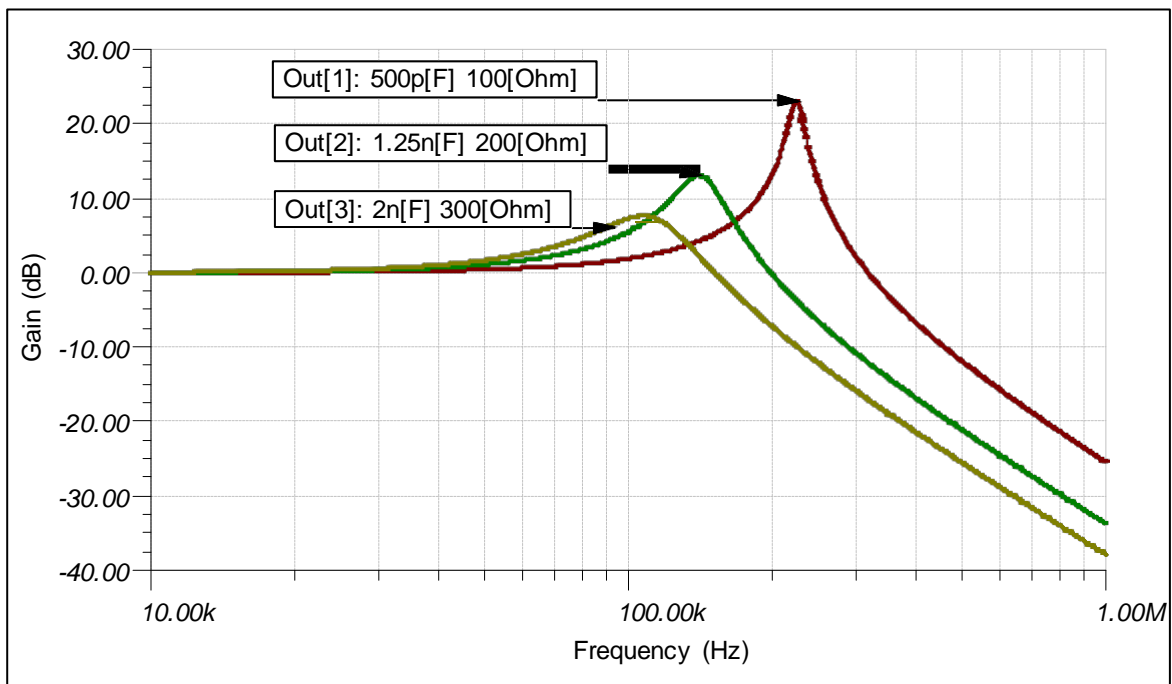

Note that the labels on the curves were generated by using the  Auto Label button of the Diagram Window.

Finally to learn about the effect of the *Separate cases in diagram* checkbox, enable this option in the Analysis Mode Selection dialog as shown below:

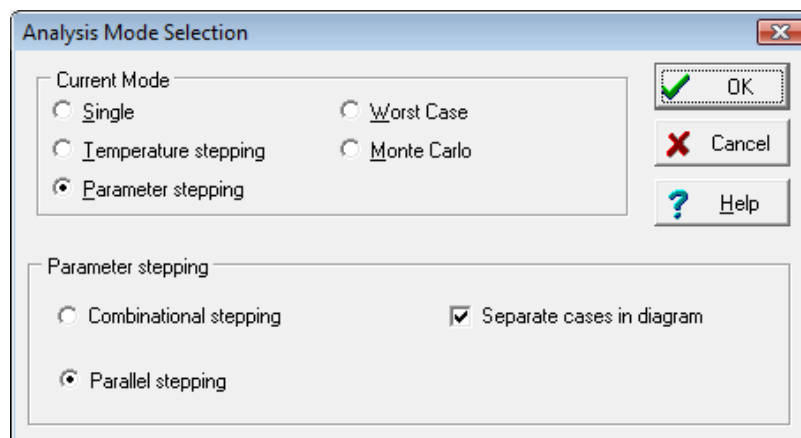

## Parameter Stepping

Now calculate AC Transfer Characteristics again. After adding the labels you will have 3 separate diagrams under 3 different Tabs of the diagram window.

For the first step under the tab AC Ampli1:

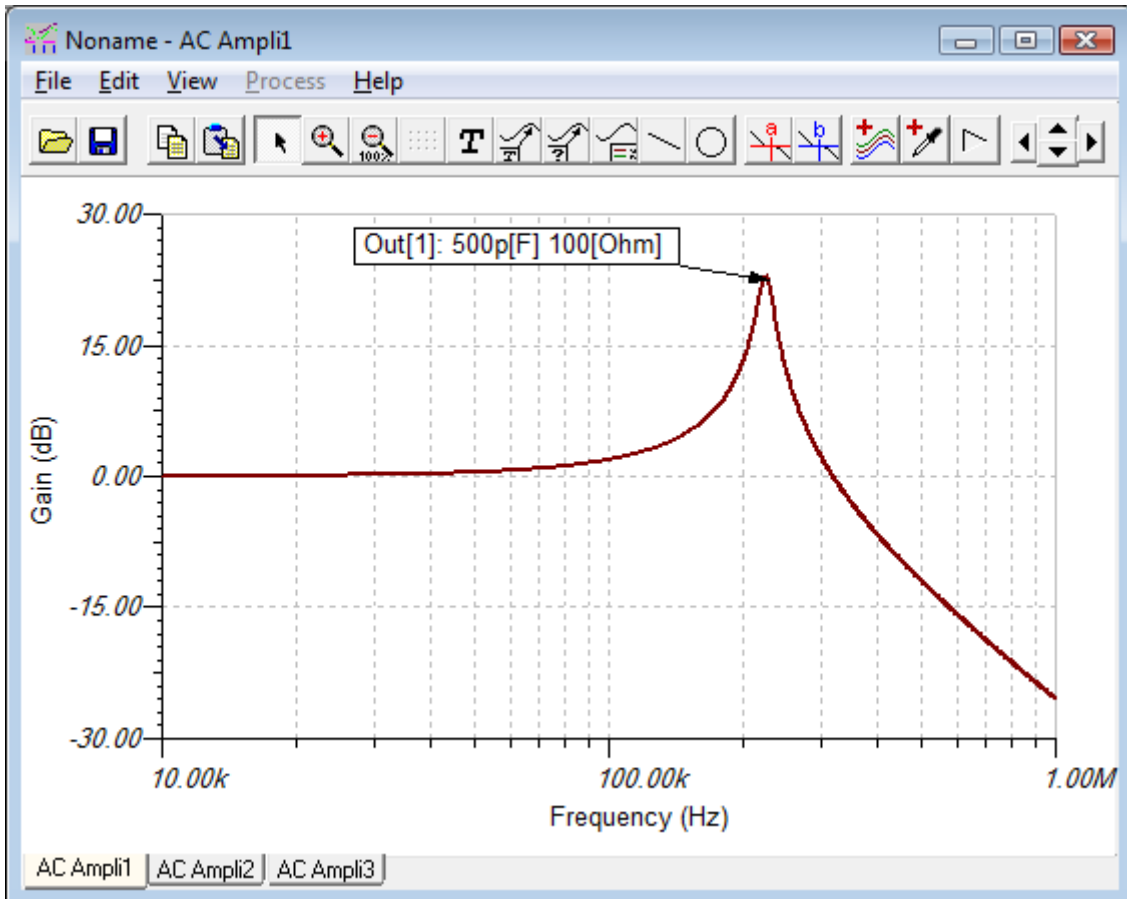

For the second step under tab AC Ampli2:

## Parameter Stepping

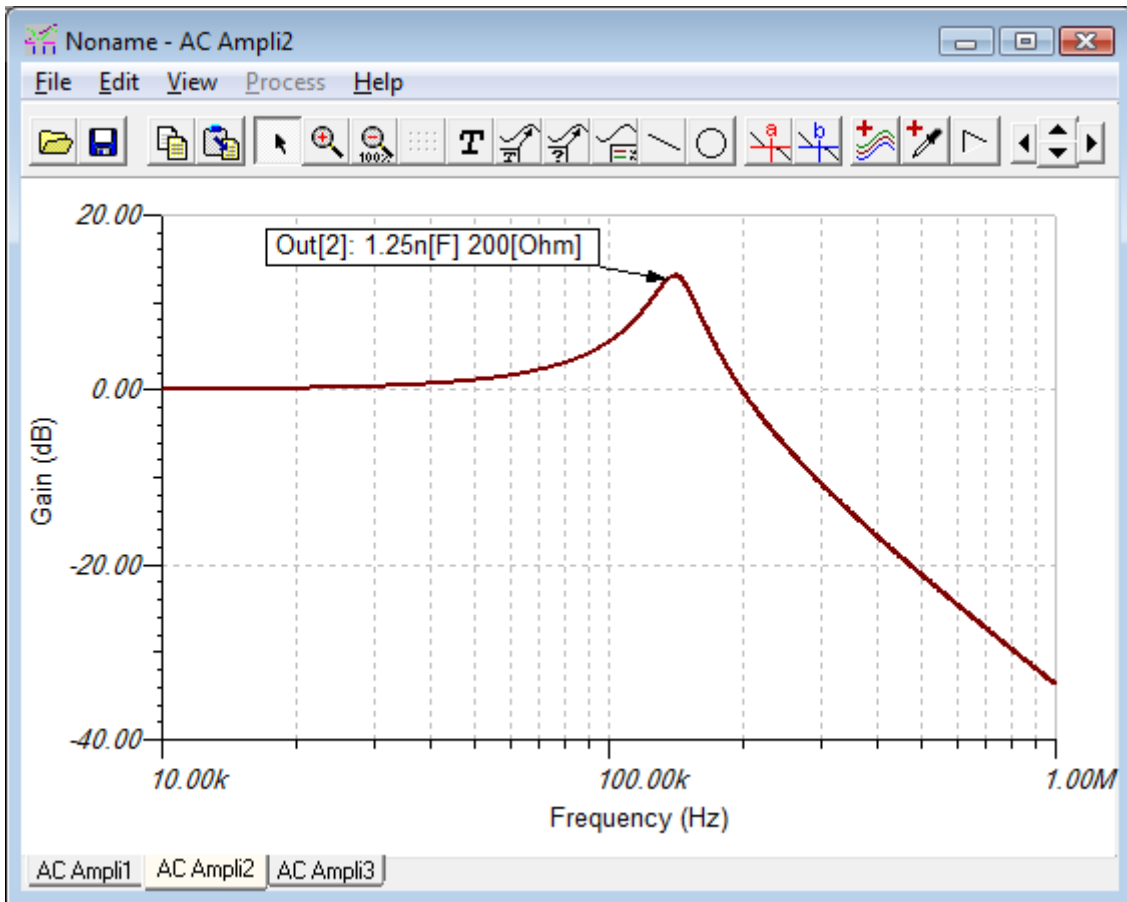

and finally for the third step:

## Parameter Stepping

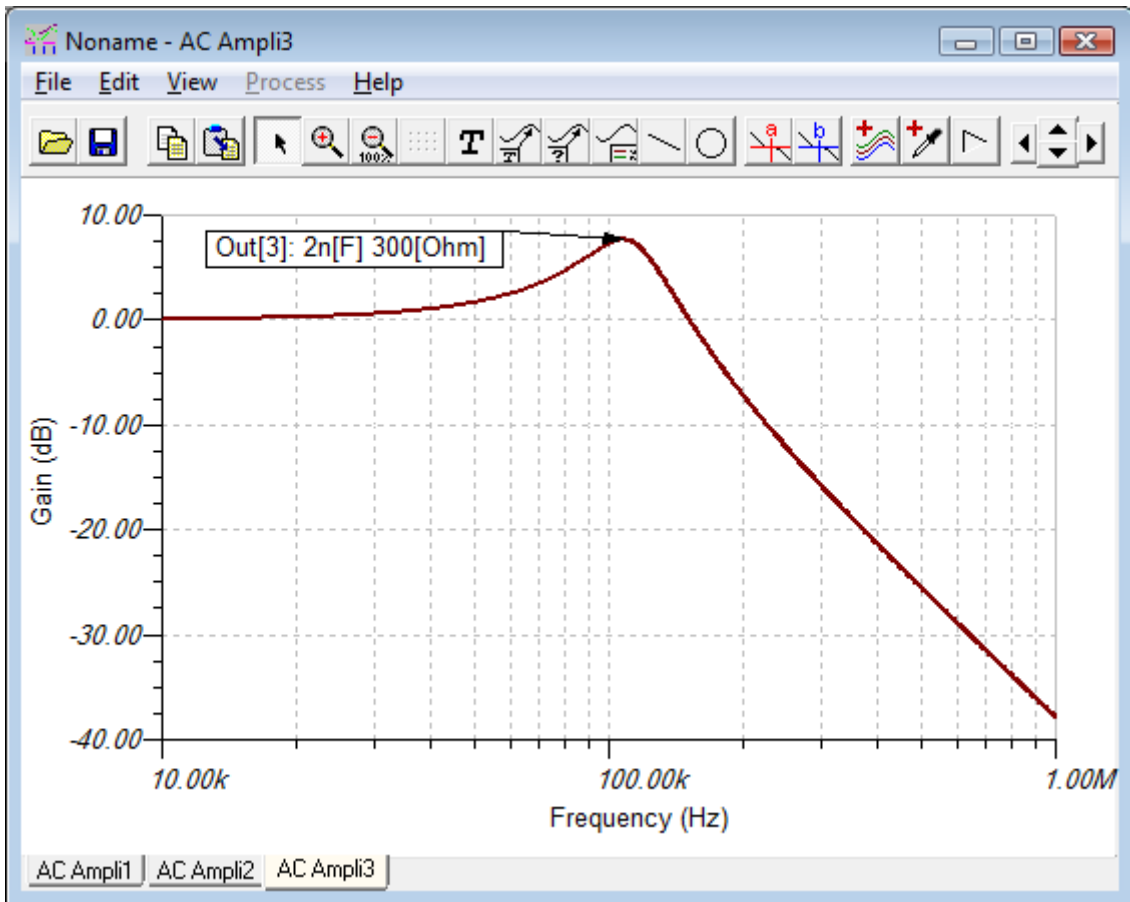

The curves are the same but shown in separately in different diagrams as the curves for the Parallel stepping without the *Separate cases in diagram* option. You can use these separate diagrams to document test benches, a suite of test circuits, each with a particular set of values that simulate devices under test.

## DC Transfer Characteristic and parameter sweeping

To calculate a DC transfer characteristic, you should assign exactly **one** input (normally a voltage or current source or generator, or a resistor) and at least one output. Later, you can change the assigned input in the DC Transfer Characteristic dialog window. You can also add more outputs using the post-processor. Plotting a result as a function of a range of resistor values is called DC parameter sweeping.

There are several ways to assign a component to serve as the input.

1. In TINA Version 6, the simplest way is to select the part from the Input list box of the DC Transfer Characteristic dialog window. Once selected, TINA will remember it and it will be saved as the selected input in your circuit file.
2. Use the I/O state field of generators and sources to assign them as input.
3. You can also use the Insert/Input command to assign an input to a source/generator or to a resistor. First select the Insert/Input command and see a special **I<sup>+</sup>** shaped cursor appear. Click the first node of the component to be selected and hold down the mouse button while you drag the input to the other node. The Insert/Input command is not the easiest way to select a DC Transfer input: method one or two is preferred.

To assign an output, use any appropriate meter from the Meters Toolbar (Voltage Pin, Voltage Meter, Ampere Meter, Power Meter, etc.) or use the Insert/Output command. In most cases, a meter is the best choice; however, if your output is on nodes far from each other, the Output command might be useful.

## DC Transfer Characteristic

---

After you have assigned at least one output, you can invoke the **Analysis/DC Analysis/DC Transfer Characteristic** command.

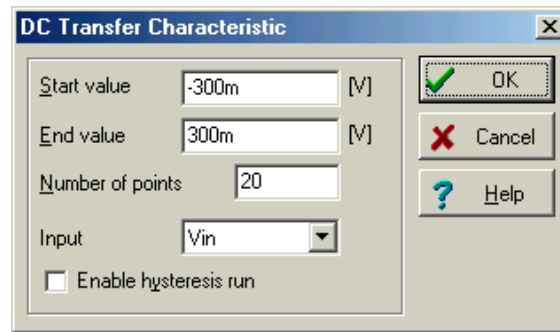

Explanation of the parameters:

**Number of points:** The program calculates the transfer characteristic at the number of points defined. The default value is 20.

**Start Value** and **End Value:** The program evenly divides the specified input range so that the number of points includes the start value and the end value. For each input point, the program calculates the output value and uses it to build the transfer characteristic. The units indicated in the square bracket correspond to that of the input ( e.g., V for a voltage generator). Normally, the input values are generated in increasing order. However, if you prefer calculation in a decreasing order, assign the greater limit of the input range to the Start value and the smaller limit to the End value. The order of calculation only matters with the DC characteristics of circuits with hysteresis (e.g., Schmitt trigger).

**Input:** Here you can check and change, if desired, the input. To change the input, click the arrow in this field and the available input quantities (label names of sources and resistors in the circuit) will appear. If a component has no label, TINA will automatically label it in the form *V\_no\_label\_1*. Click on the name to select it as the input.

**Enable hysteresis run:** If this checkbox is checked, TINA will first run an analysis varying the Input quantity from the **Start value** to the **End value**, and then run an analysis from

## DC Transfer Characteristic

---

the **End value** to the **Start value**. You should use this option for components with hysteresis (where the characteristic depends on the direction of change).

*Note that if you use a resistor as an input, TINA calculates the transfer characteristic multiple times, once for each step of the resistance (parameter sweeping).*

When running an analysis on a nonlinear network, the DC analysis might not converge at certain points. These points will be skipped when plotting the response. If they are at the start and/or end values, the displayed (input) range will be truncated accordingly.

Let's look at two examples.

First, let's draw the characteristics of a bipolar transistor (CHARBIPO.TSC)

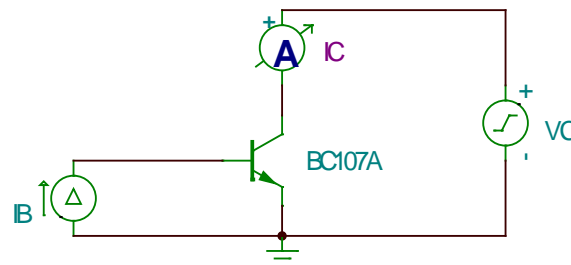

Select the current source and Analysis/Mode to see how the base current,  $I_B$ , is stepped.

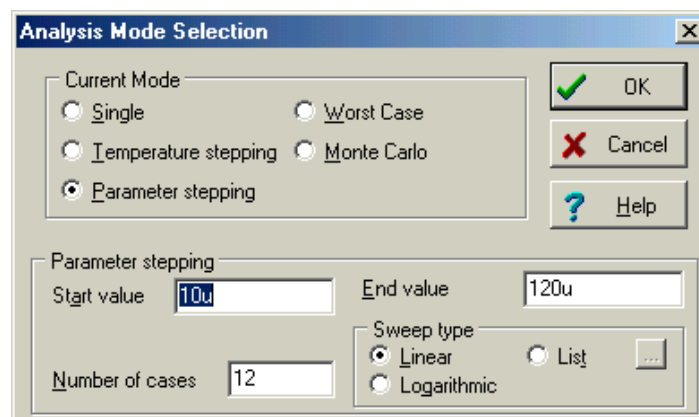

## DC Transfer Characteristic

Then invoke the Analysis/DC Analysis/DC Transfer Characteristics command. See the following dialog:

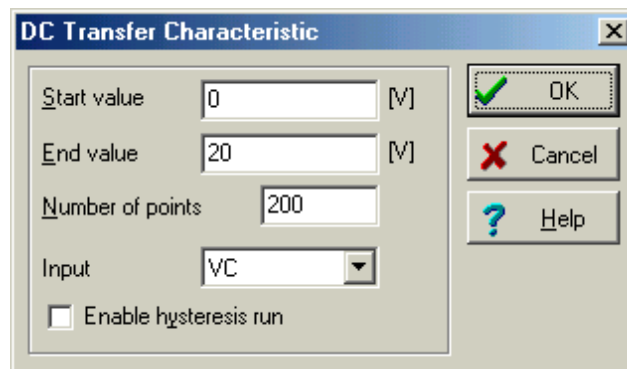

According to the dialog window, the input, VC, will be varied from the Start value (0V) to the End value (20)

The result is familiar family of curves that constitute the common emitter characteristic of a transistor.

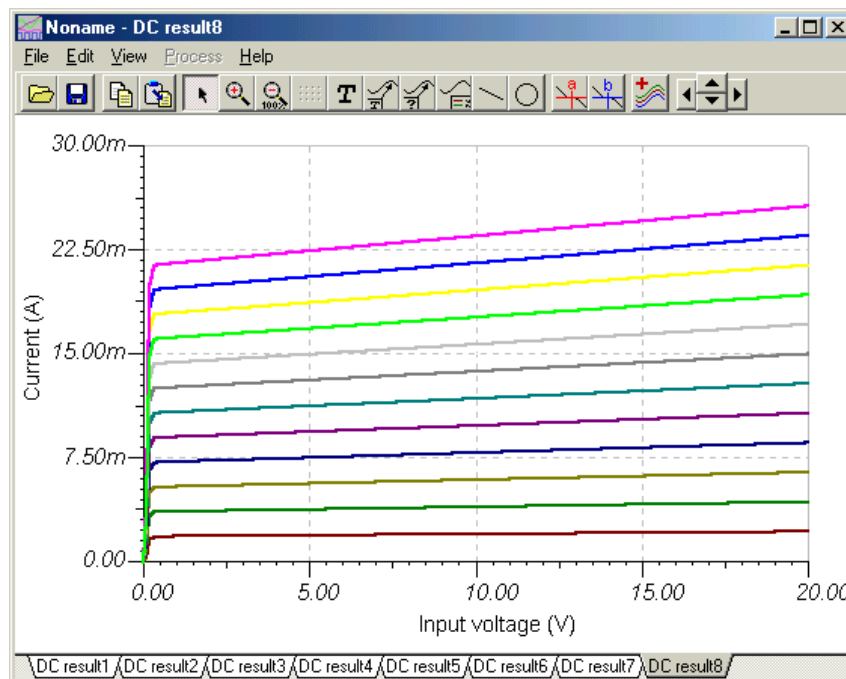

Now let's see an example of parameter sweeping (sweep.tsc)

The circuit:



## DC Transfer Characteristic

---

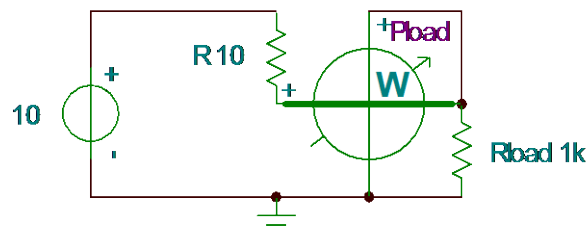

The output is the power meter, showing the dissipation on Rload.

If you invoke the Analysis/DC Analysis/DC Transfer Characteristics command, you'll be greeted by this dialog box:

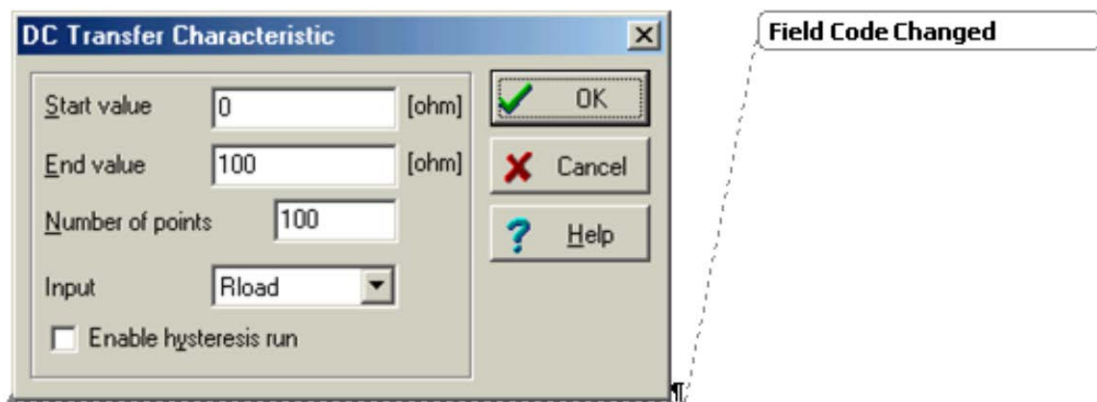

*Note that the resistor Rload is swept from 0 to 100 ohms.*

Press OK to obtain the following diagram:

## DC Transfer Characteristic

---

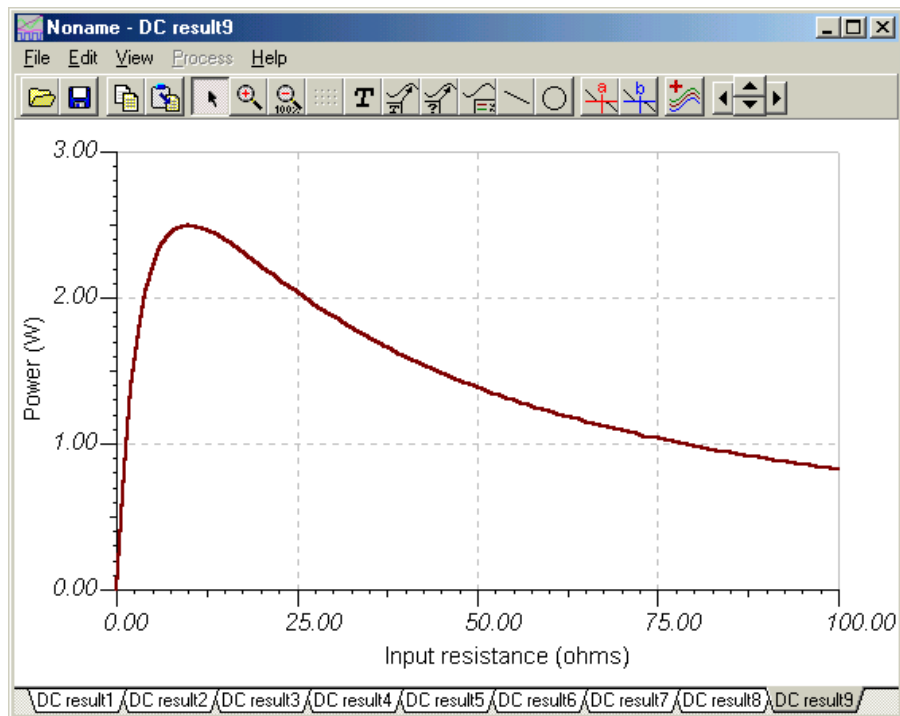

This is the well known curve of power dissipated on a load resistor as the load resistance is varied. Maximum power is transferred when the source resistance and load resistance are equal.

# Phasor diagram

The phasor diagram is a great tool for demonstrating and studying circuit operation via complex phasors (vectors). Phasor diagrams can be used only with AC analysis with linear circuits, or with nonlinear circuits in working point linearization.

Let's use TINA to draw the phasor diagram of an RC circuit.

First open the circuit RC.tsc in the examples\phasor directory.

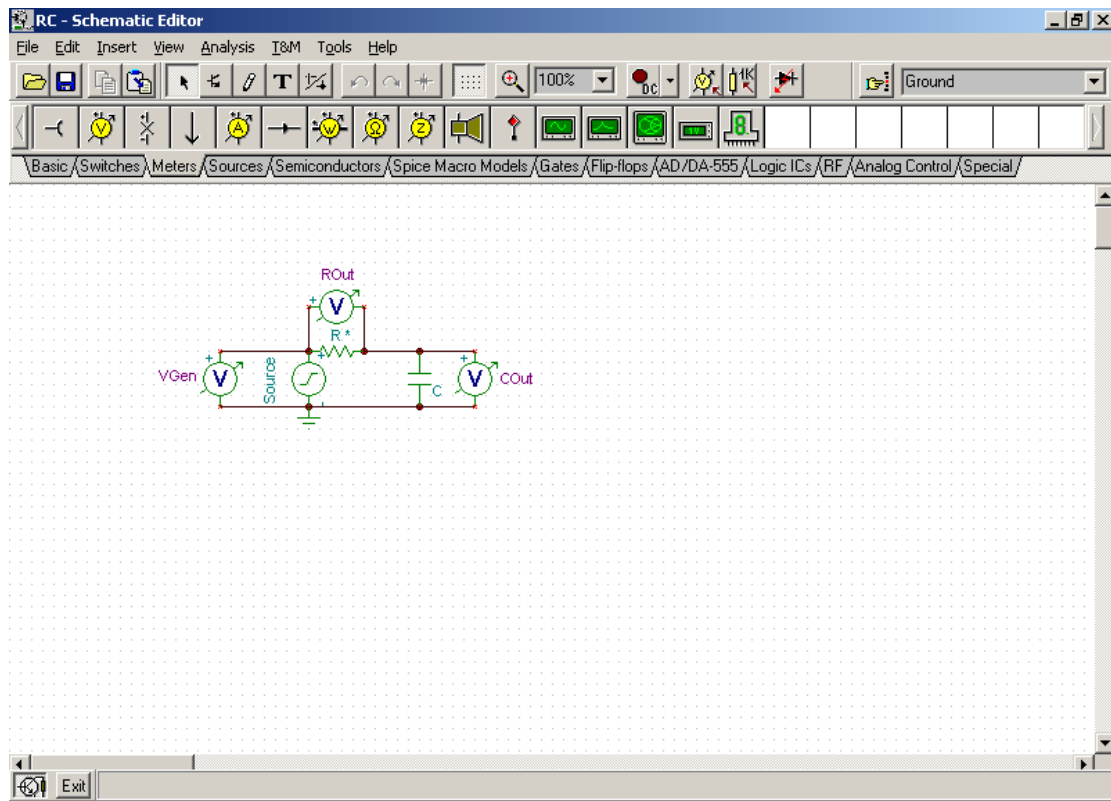

Run the *AC Analysis.Phasor diagram* command. TINA generates a new diagram containing three vectors in the diagram window. As you can see,  $V_{gen}$  is the vector sum of  $R_{out}$  and  $C_{out}$ , but to make this clearer you can change the position of the vectors.

By default all the vectors originate from the origin of the coordinate system; however, you can translate them by simply clicking and dragging them into another place. When you drag a vector close to

## Phasor Diagram

another vector's starting or ending point, it will be automatically snapped to it. Try dragging the vector Rout to the end of Cout to form a triangle with Vgen. Notice that when you move the cursor above a vector, TINA presents its name, amplitude, and phase in the status-line.

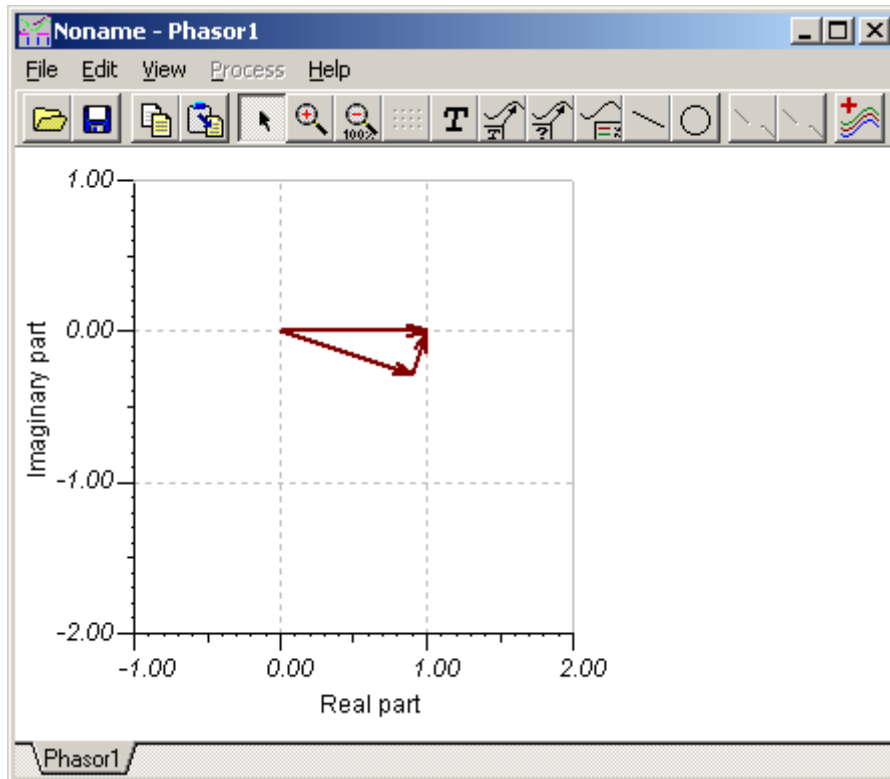

If you prefer a display without axes, turn the axes off using the *View.Display axes* menu.

If you double click on a vector (or right-click it and select Properties), the vector's configuration dialog box appears. In addition to the usual settings for the vector's color, width, and style, you can also set the vector head style.

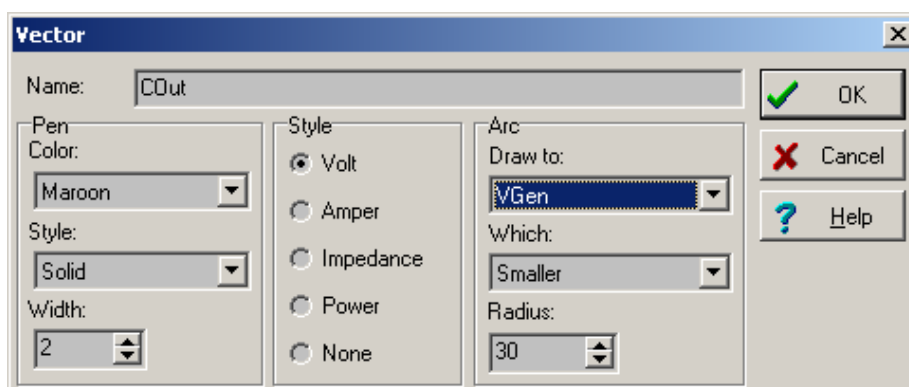

## Phasor Diagram

---

Using the Arc settings, you can draw an arc between  $C_{out}$  and  $V_{gen}$  by setting  $V_{gen}$  in the *Arc.Draw to* listbox of the  $C_{out}$  vector's configuration dialog box. You can also set the radius of the arc in pixels and choose whether the smaller ( $\leq 180^\circ$ ) or the bigger arc ( $> 180^\circ$ ) should be displayed.

Next, you can add labels to all the vectors at once by pressing the legend button on the toolbar. You can also add legends individually: press the *Auto label* button, then select the vectors one-by-one. The actual label format depends on the selected *Vector label style* under the *View* menu. Finally, you can add lines, circles, or texts to finish your diagram.

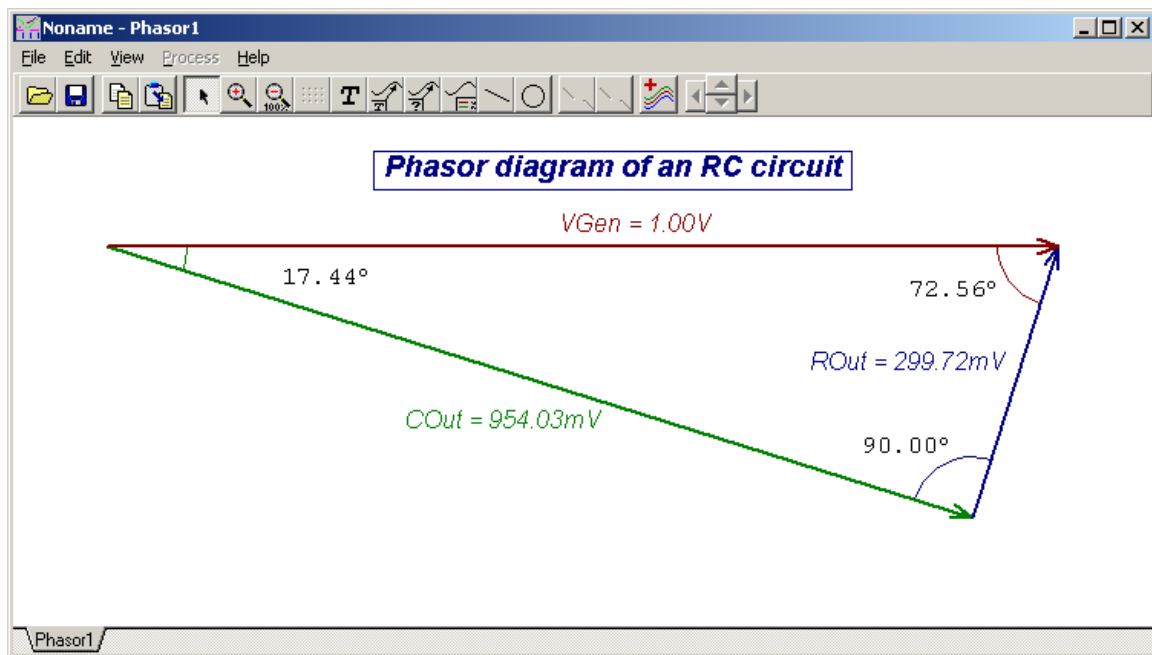

This diagram can then be copied to the clipboard and pasted into the schematic editor or any word processing program.

## Nyquist Diagram

TINA's AC transfer analysis can plot not only the Amplitude, Phase and Group delay of the transfer function of analog circuits, but the Nyquist diagram as well. To see how this works, first load the examples\rlc\_1.sch circuit. Next, select the Analysis.AC Analysis.AC Transfer Characteristic menu item. Now the AC Transfer Characteristic dialog box appears on screen, where you can select the Frequency ranges of the analysis, the sweep type, and the diagram you want to plot (Amplitude, Phase, Nyquist, Group Delay).

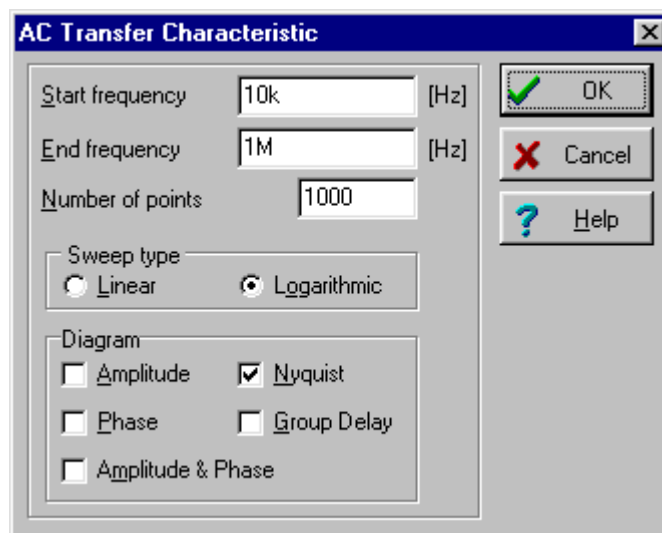

Set the frequency from 10k to 1M and set the diagram type to Nyquist. In order to get a smooth curve, increase the Number of point to 1000. Press the OK button and see the Nyquist diagram of the circuit calculated and plotted, as shown in the diagram window.

## Nyquist Diagram

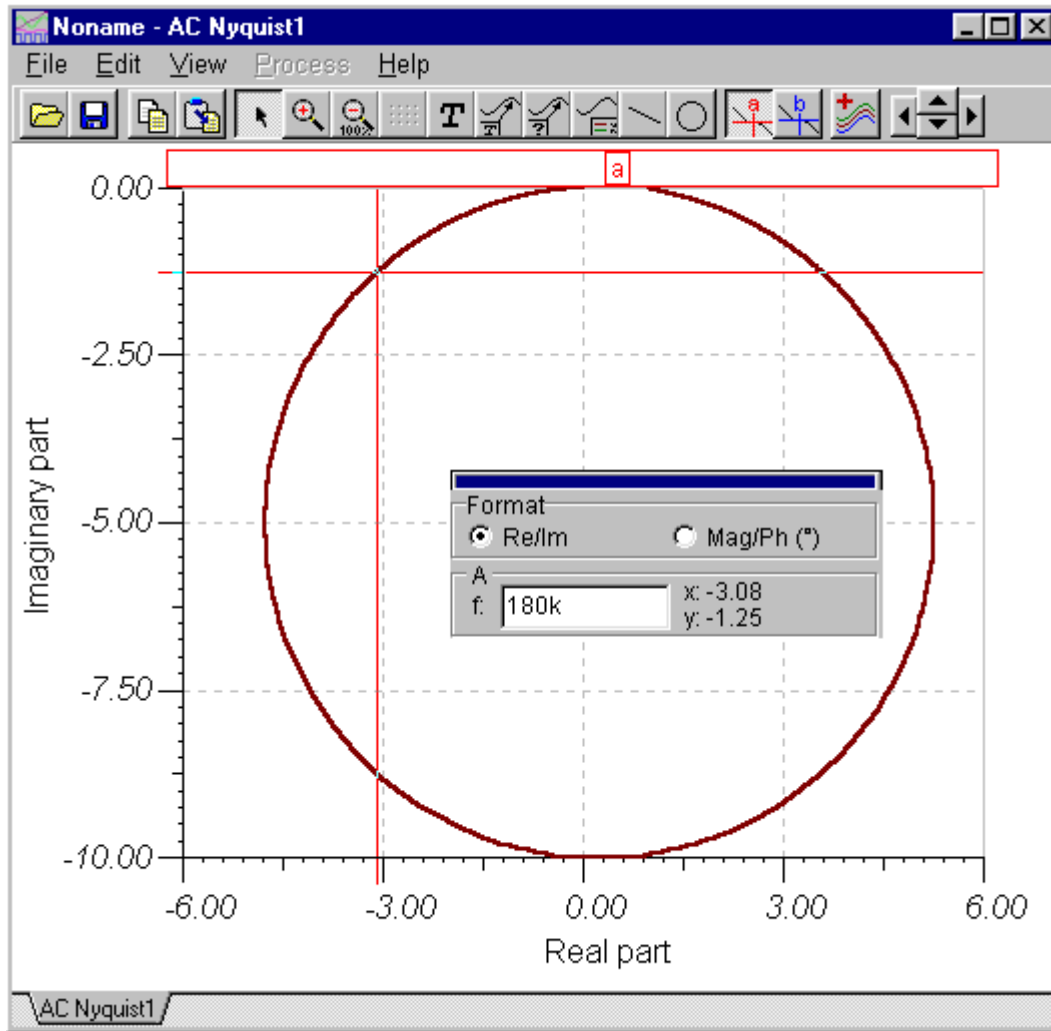

This diagram is different from a normal Transient or AC analysis diagram. A Nyquist diagram requires that horizontal and vertical scales always be proportional to each other. This keeps circular curves circular, even if you resize the window. Furthermore, a Nyquist curve presents the trace of a vector quantity as frequency is varied. When you activate a cursor and explore the trace, the cursor dialog shows the numerical values of the curves at a given frequency, in either real-imaginary or amplitude-phase format.

# Noise Analysis

In TINA there are two models of noise analysis available:

- Small signal AC Noise Analysis
- Transient Noise Analysis

## Small signal AC Noise Analysis

In this Analysis mode TINA calculates the noise contributions of circuit components and then presents them referred to the output in frequency domain. The random noise fluctuations are analyzed statistically, considering the time domain average to be zero, while the variance and sum of the squares are not zero. Noise analysis results can be displayed and printed over a frequency range similar to the Bode diagram of AC analysis.

TINA takes into account the noise sources inherent in resistors and semiconductors (transistors, diodes). Resistors are modeled as an ideal noiseless resistor in parallel with an equivalent thermal noise current. This equivalent noise is modelled by white noise, i.e., noise containing all frequency components with the same amplitude density. The contributions of all the noise generators in the circuit are calculated to determine each one's magnitude at the output. The 'output noise' is formed from the square root of the sum of the squares (rms value) of these individual contributions.

To correctly account for the noise contribution of operational amplifiers, you should use models made by manufacturers by choosing devices from the Spice Macro Models toolbar. Open the macro and check the noise model. Some manufacturer models have special purpose noise models, or no noise modelling whatsoever. TINA's ideal, standard and linear opamp models (on the Semiconductor toolbar) *do not include* a noise model.

Since the transfer functions of the circuit are known, the equivalent input noise can be calculated from the output noise. Expressing all the



## Noise Analysis

---

circuit noise in terms of an equivalent input noise makes it possible to compare the levels of real signals presented to the input to the circuit noise referred to the input. A circuit expected to amplify small input signals, signals approaching the magnitude of the equivalent input noise, will not be very useful.

Resistors generate resistive (thermal) noise which is computed as the following source current:

$$i^2 = \frac{4 \cdot k \cdot T}{R}$$

where

$k = 1.38e-23$ (Wsec/K)	Boltzmann constant
$T =$ temperature in K	$R =$ resistance in ohms

Semiconductors generate not only thermal noise (similar to resistors), but flicker noise (1/f noise) as well. The spectral density of flicker noise decreases in inverse proportion to the frequency, hence the name 1/f noise.

TINA calculates the Input and Output noise and expresses the noise as the noise voltage per  $\sqrt{Hz}$  of bandwidth.

TINA can also present noise as a curve of Total noise, at the output, as a function of frequency. In computing this curve, TINA sums all the noise from the start frequency up to the specified maximum frequency value and presents it as total noise. Naturally, the curve rises monotonically. For example, if you set the start frequency to 20Hz and the end frequency to 20kHz, you will learn the total output noise over the typical audio bandwidth.

Another measure of noise, the “signal to noise ratio,” takes the signal magnitude into account. This is the ratio of signal power to noise power, according to the following formula:

$$S / N = 20 * \log \frac{V_{Sig}}{V_{Tot}}$$

## Noise Analysis

where  $V_{Tot}$  is the total input-referred noise voltage and  $V_{Sig}$  represents the expected signal amplitude.  $V_{Sig}$  is a user-defined value that you enter in the Noise Analysis dialog. The default value is 1mV.

To get a better feeling for these noise concepts, let's study the following circuit, an equivalent circuit of a basic amplifier (noise.tsc).

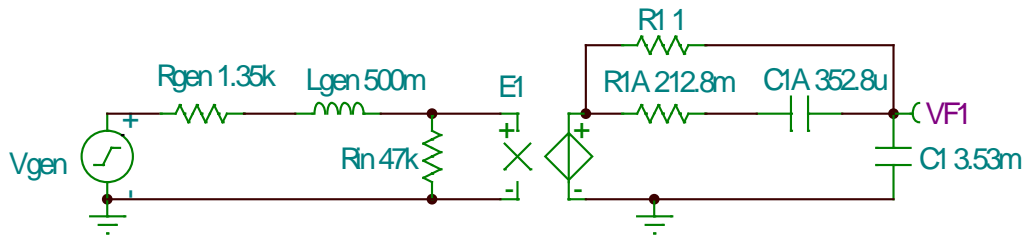

Select Analysis.Noise Analysis. The following dialog appears:

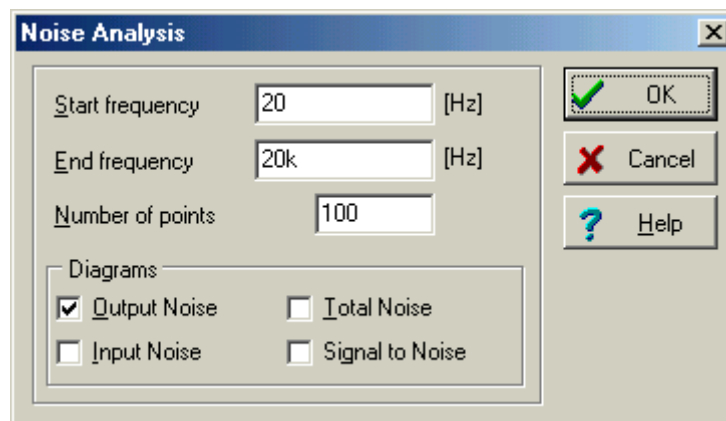

The dialog allows you to set the **Start frequency**, **End frequency**, the **Number of points** for which the noise is to be computed, and the **Signal amplitude**. You may also select the required analysis results—Output Noise, Total Noise, Input Noise, and Signal to Noise.

# Noise Analysis

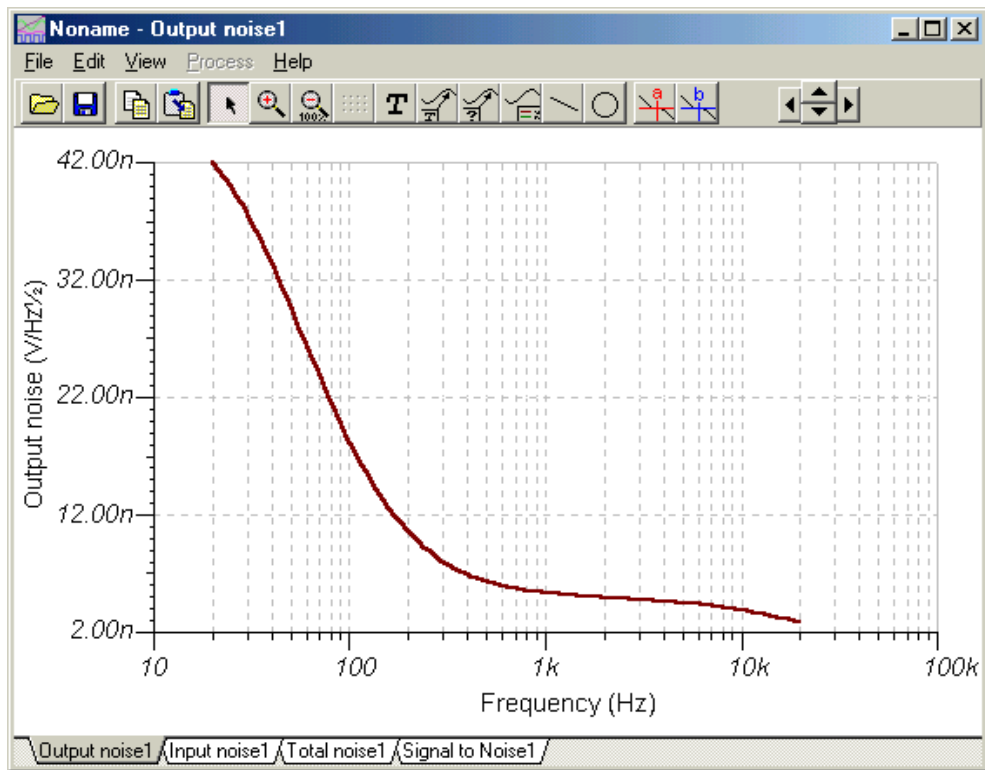

Output noise

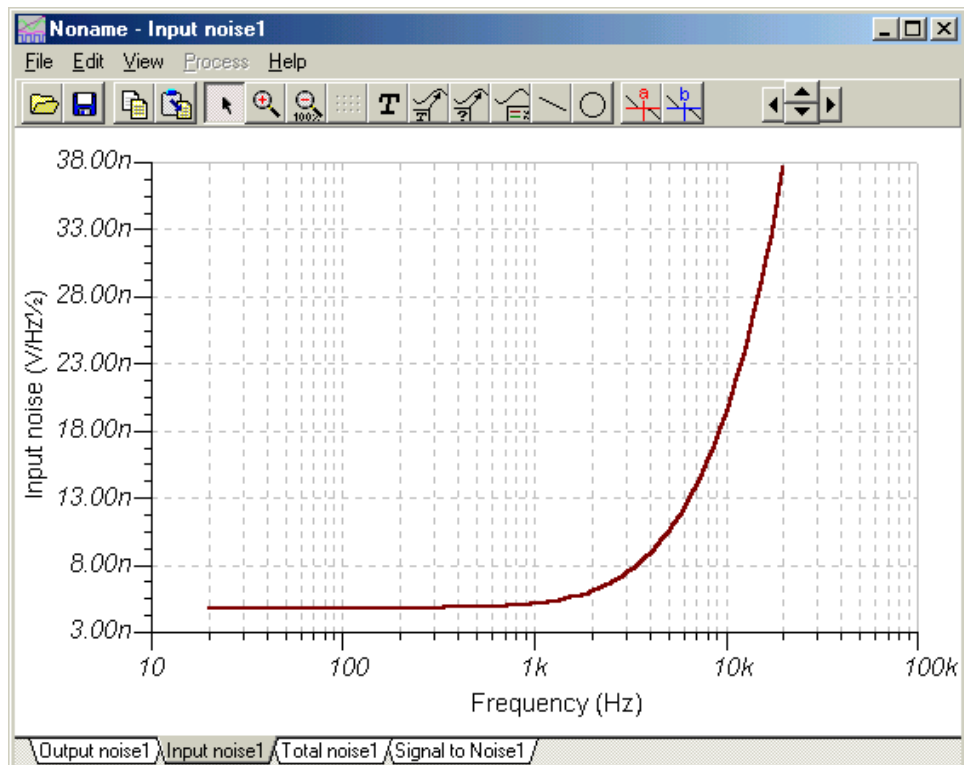

Input Noise

# Noise Analysis

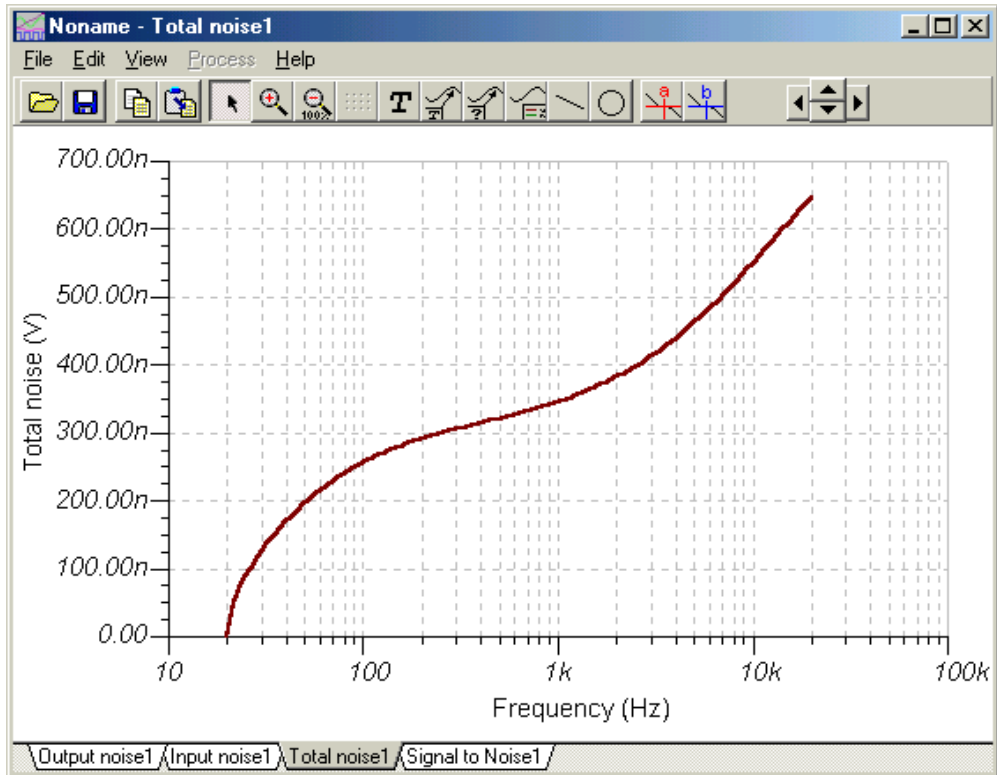

Total Noise

### Transient Noise Analysis

Noise effects are usually simulated with linear AC noise analysis which is also available in TINA. However when the noise influences the system behavior in a nonlinear way, linear noise analysis is no more satisfactory and transient noise analysis, that is simulation in the time domain, is necessary. Here are a few examples:

- Noise analysis of oscillator circuits
- Analysis of noise effects in digital circuits
- Analysis of circuits with noisy input signals
- Analysis of systems with low signal-to-noise ratio

The voltage and current generators of TINA now include a parameterizable white noise signal, and in the Noise Analysis folder of TINA application circuits are available to generate other typical noise signals, which make transient noise analysis possible

**Let us demonstrate transient noise analysis with an oscillator circuit where the linear AC noise analysis is not possible since oscillator circuits are strongly nonlinear systems. Our example is based on the following publication:** A Study of Phase Noise in CMOS Oscillators by BehzadRazavi, IEEE JOURNAL OF SOLID-STATE CIRCUITS, VOL. 31, NO. 3, MARCH 1996

**We refer to the above paper for the theoretical details, here we just describe the main simulation settings.**

**Open the Relaxation Oscillator Noise.TSC circuit from the Noise Analysis folder of TINA.**

# Noise Analysis

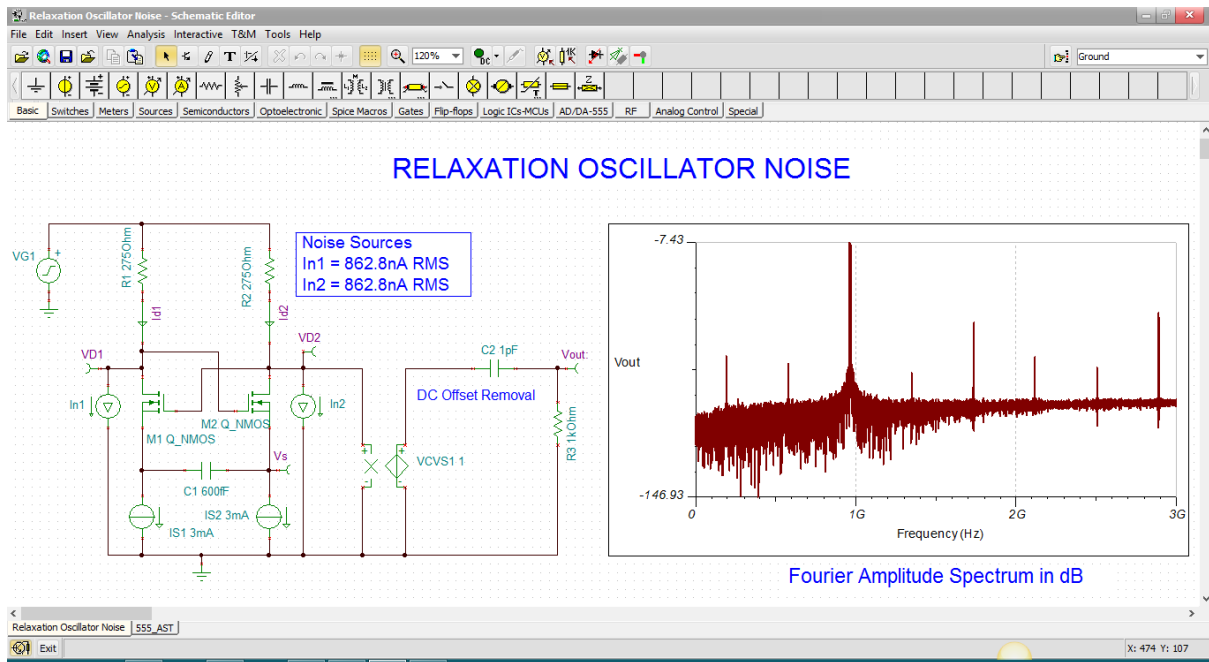

The noise is injected into the circuit through the In1 and In2 white noise generators with 862.8nA RMS both. Doubleclick on In1 and observe that the Signal type is set to Noise.

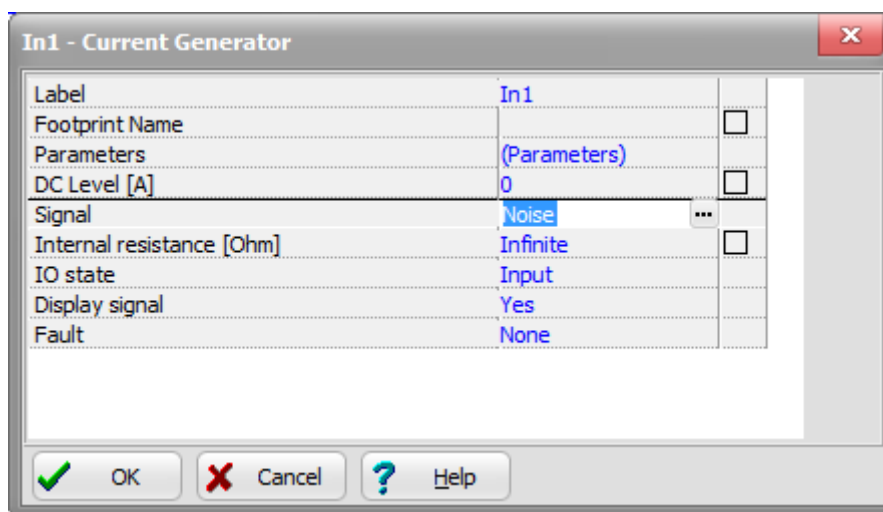

If you click the ... button in the Signal line the settings of the white noise generator appears.

## Noise Analysis

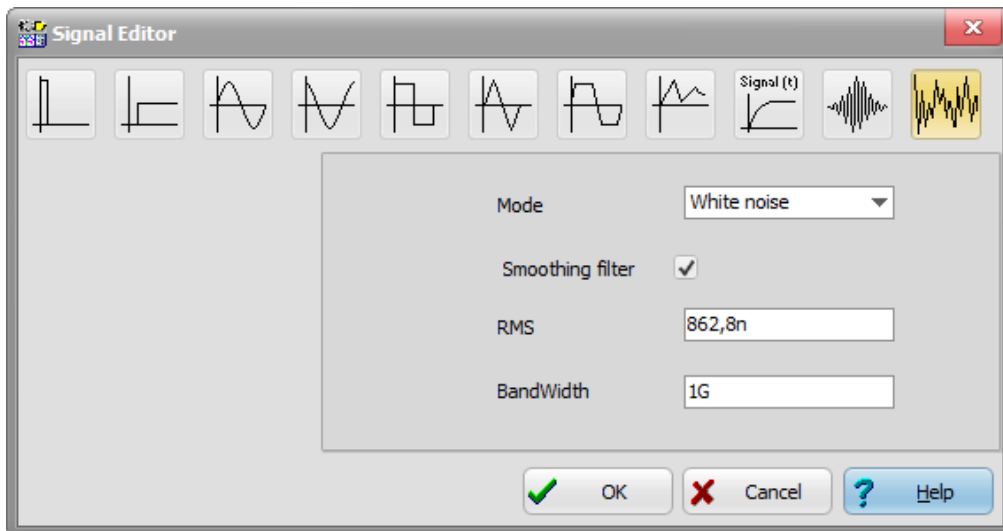

The result was obtained by Fourier Spectrum analysis. You can either run a Transient Analysis then click the waveform and from the Process menu select Fourier Spectrum or select Fourier Spectrum directly from the Analysis menu. In both cases the suggested Fourier Spectrum dialog setting are as shown below.

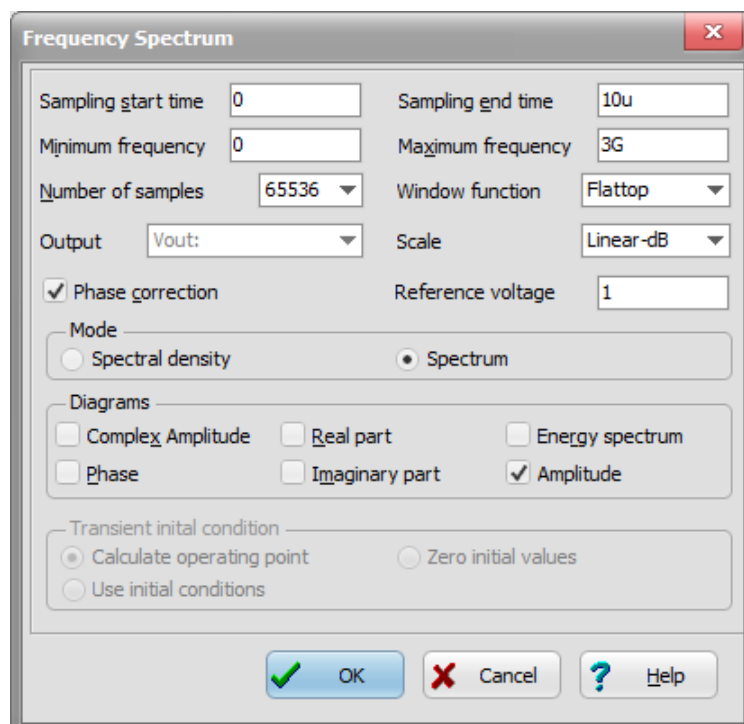

As usual you can place the diagram on the schematic editor using copy in the diagram then Paste in the main schematic window of TINA.

# Network Analysis and S-parameters

## Network Analysis

TINA helps you perform network analysis and determine the two-port parameters of networks (S, Z, Y, H). This is especially useful if you work with RF circuits. Results can be displayed in Smith, Polar, or other diagrams.

The network analysis is carried out with the help of TINA's network analyzer. The RF models of the circuit elements can be defined as SPICE sub-circuits (SPICE macros) which contain parasitic components (inductors, capacitors) or as an S-parameter model defined by its S (frequency) function. S functions are normally provided by the component manufacturers (based on their measurements) and can be downloaded from the Internet and inserted into TINA either manually or by using TINA's library manager.

Let's get started with an example. Open the circuit examples\rf\spar\_tr.sch.

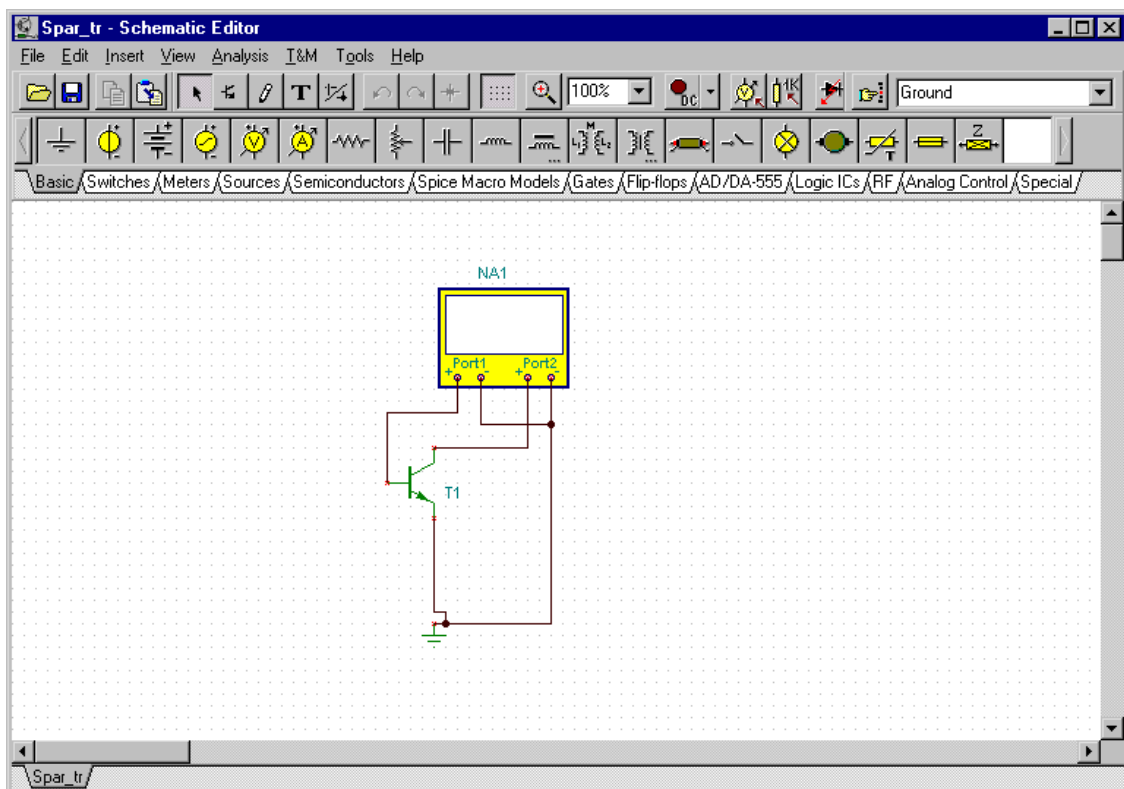



## Network Analysis and S-parameters

This circuit consists of a network analyzer connected to an RF transistor. The first port of the network analyzer measures the base-emitter characteristic while the second port measures the collector-emitter characteristic of the transistor. If you double-click on the transistor, you will see that the actual characteristics of this transistor are defined by its S11, S12, S21, S22 parameters, and R1 and R2 input/output impedances.

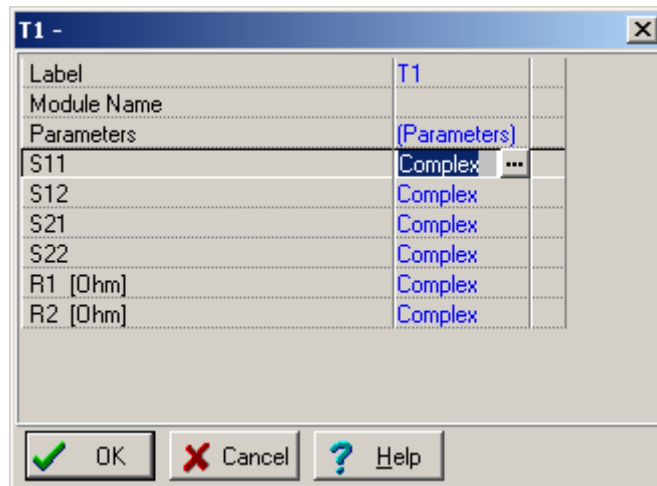

Each function is defined as a table of the S parameter and frequency. If you click on the ... button beside the Complex label, you can see this table.

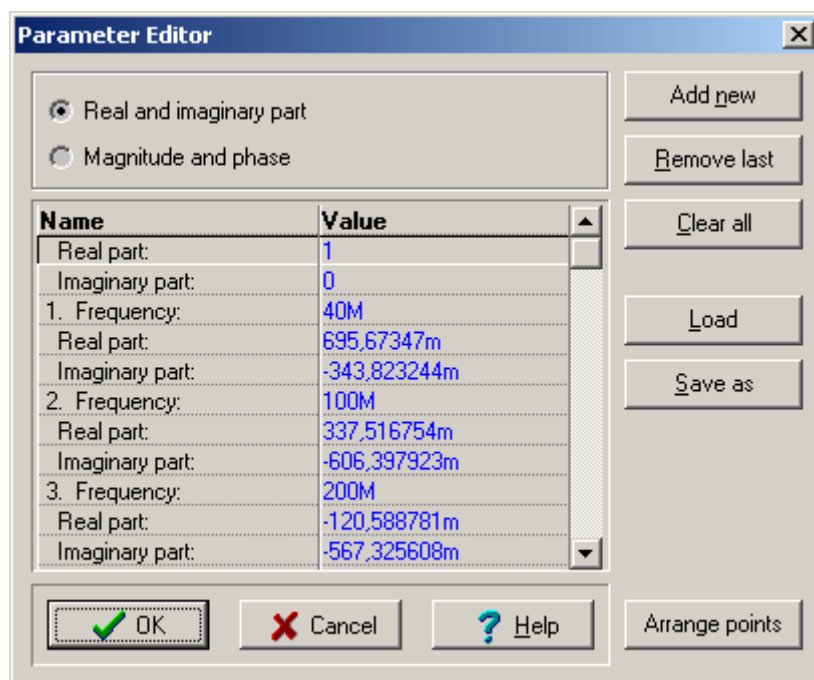

You can easily add more points to the function with the *Add new* button or load an entirely new function with the *Load* button. Similarly, the *Remove last* button removes the last point, and the *Clear all* removes all the points from the list. The *Arrange points* button sorts all the points in ascending order of frequency.

*Note that TINA comes with many other models defined by S-parameters (under the RF toolbar).*

Close all the dialog boxes and run Analysis.AC analysis.Network analysis. Among many other parameters in the dialog, you can specify the frequency range and the mode (i.e., what to draw) of the analysis.

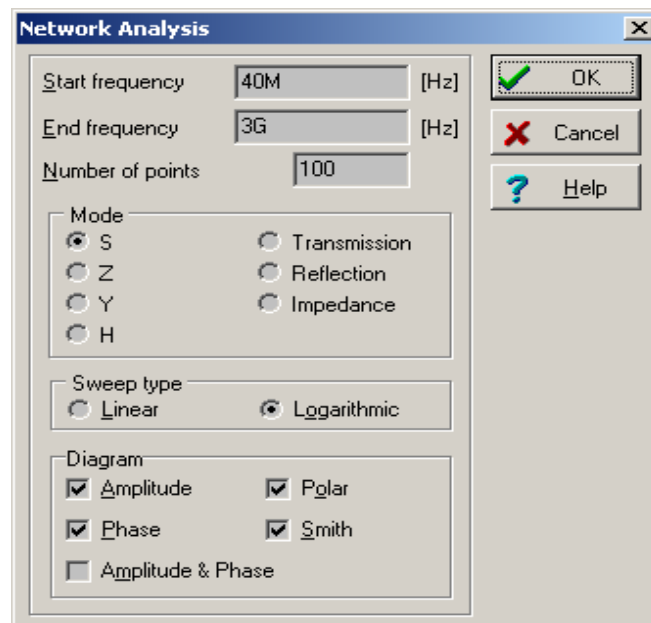

The diagrams available depend on the selected analysis mode. In S Analysis, the Amplitude, Phase, Polar, or Smith diagram can be drawn. Let's select Analysis mode S, the Amplitude, Phase, Polar and Smith diagram types, and press OK. Four new pages are inserted into the diagram window. Each new page contains four curves, the S11, S12, S21, and S22 curves, displayed in the appropriate diagram style. You can obtain specific data values by placing a cursor on the desired points. When you place the cursor on a Smith curve, a special cursor diagram comes up, which can display the curve's values in the format set with the *Format* and *params* (S-params, Z-params, etc.) fields.

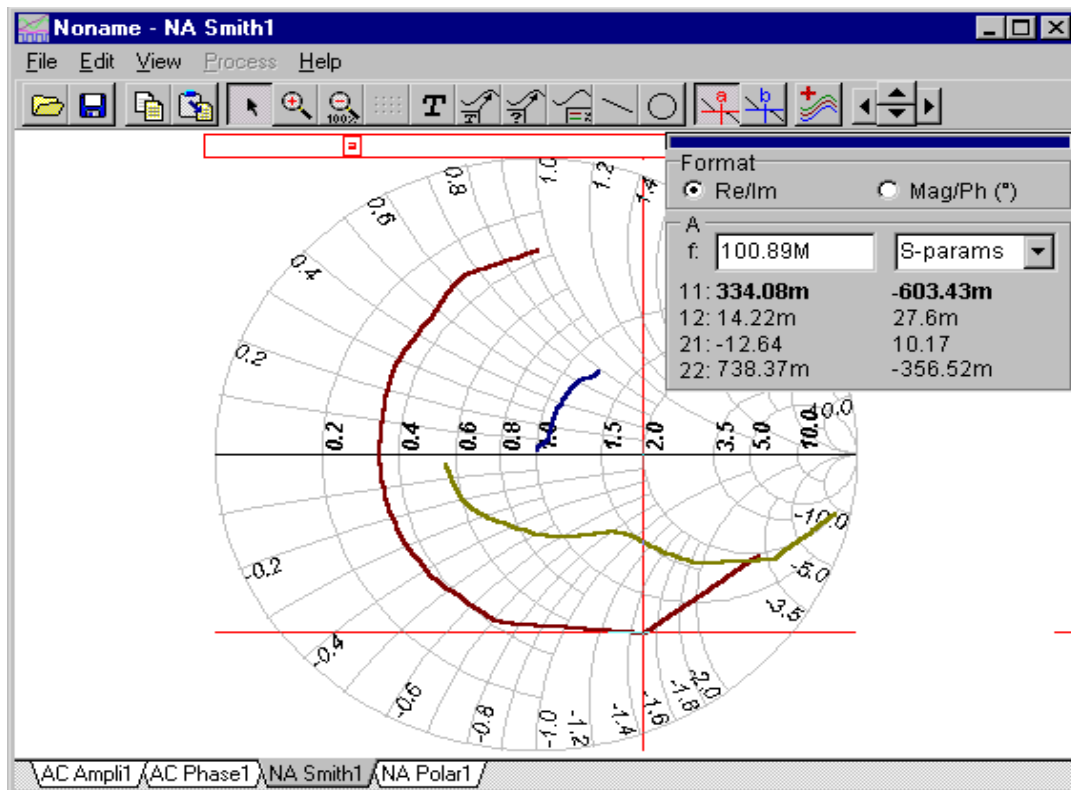

You can annotate these diagrams, as you can any other diagram types, by adding texts, circles, and lines. You can explore data values of particular points on the curves using the cursors, and zoom in and out. But for Smith and Polar diagrams, axis settings are handled differently. Even though these diagrams look like polar diagrams, the coordinate ranges are defined in the real-imaginary domain. The real part (i.e. real axis) can be set by double clicking on the horizontally aligned numbers (on the Polar diagram the amplitude values), and the imaginary part by double clicking on the circularly aligned numbers (on the Polar diagram the Phase values). You can set the format of the numbers and the horizontal or vertical range of the diagram using the dialog that appears.

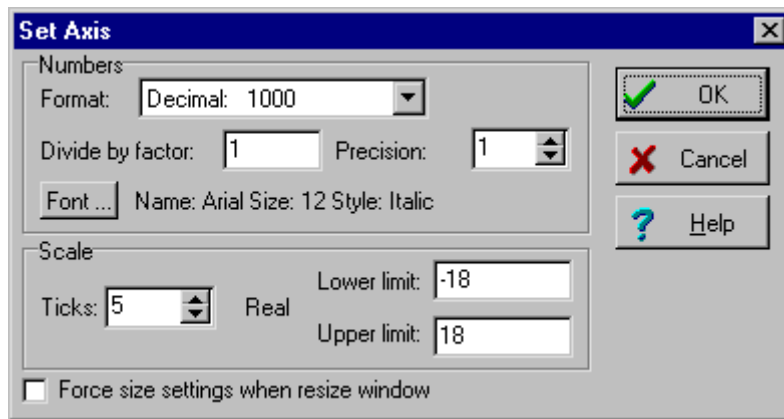

Models for Network analysis can also be defined using SPICE subcircuits. To demonstrate this, open the circuit examples\rf\spice\_tr.sch in the schematic editor. This example contains a circuit similar to the one we've just looked at: a network analyzer connected to a transistor, and a current source and a capacitor.

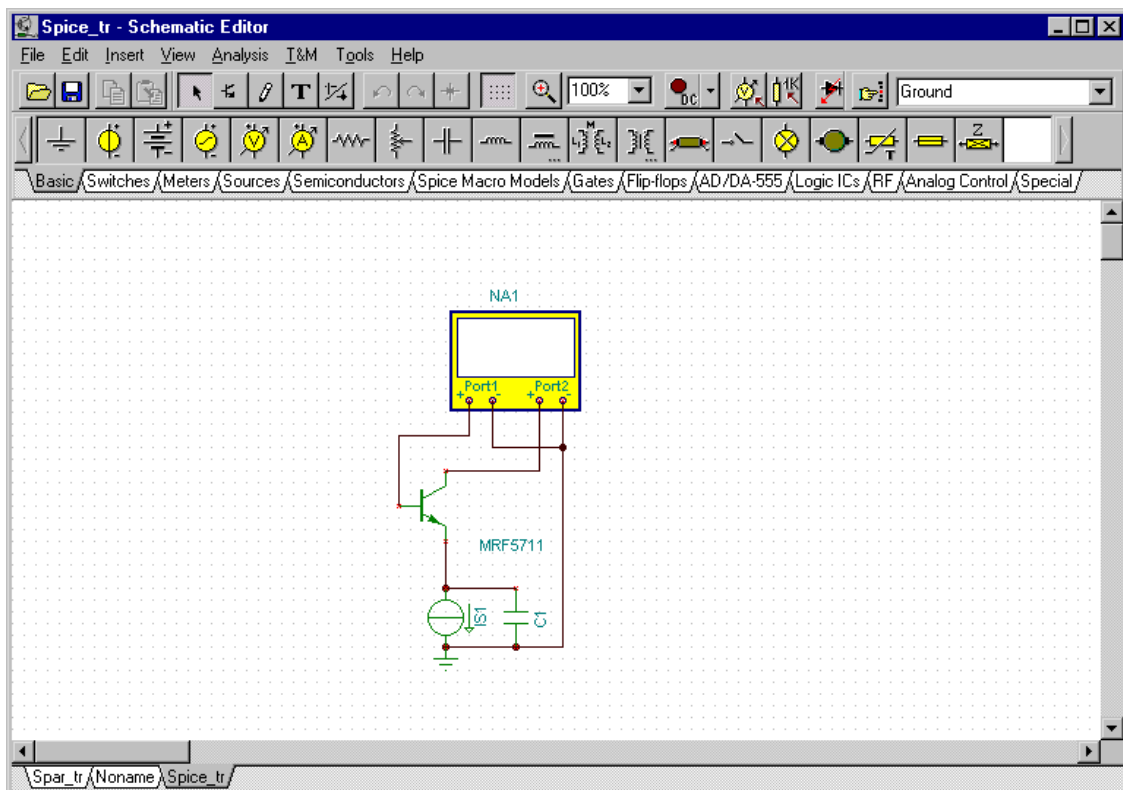

In this circuit, however, the transistor contains a SPICE subcircuit. Its netlist can be viewed by clicking *Enter macro* in its property dialog.

## Network Analysis and S-parameters

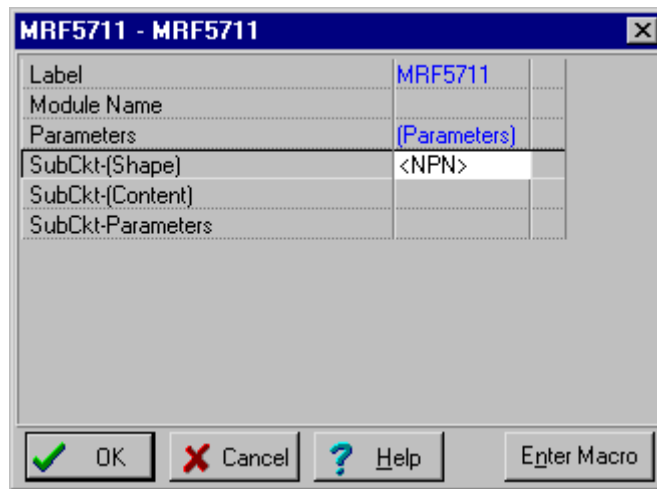

TINA contains many other RF models that can be found under the Spice Macro Models toolbar.

Now run Analysis.AC Analysis.Network Analysis again and note that the results are similar to those obtained with the S-parameter models.

Network analysis curves can also be generated using TINA's Network Analyzer under the T&M menu. To select the diagram you need, first set the Network Analyzer Mode, then the display type. After you press *Start*, the selected curves will be displayed on the instrument.

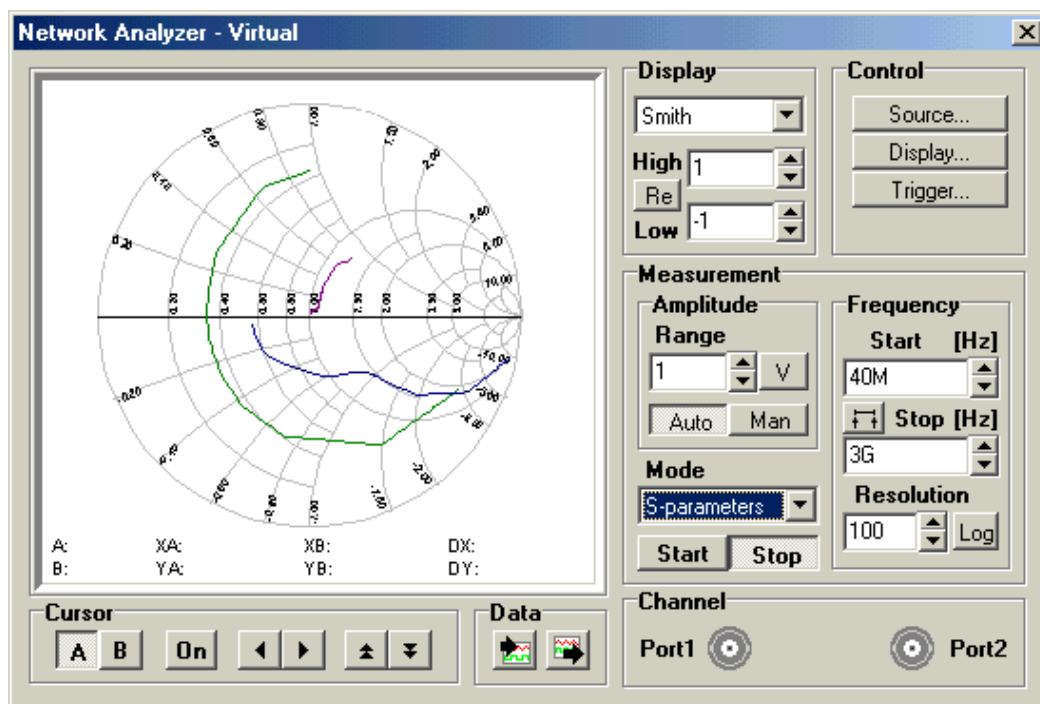

# Symbolic Analysis

## Symbolic Analysis

TINA's symbolic analysis produces closed form expressions of the transfer function, equivalent resistance or impedance, as well as the DC, AC, and transient response of linear circuits. These equations can then be inserted into the schematic editor or the diagram window. With the help of the built-in interpreter, they can be even further manipulated and displayed as a diagram in the diagram window. The formulas provided by symbolic analysis allow a unique in-depth understanding of circuit operation, invaluable both for design and education.

Let's see a few examples. First load the circuit examples\symbolic\actfilt.sch. It is an active filter with an ideal operational amplifier.

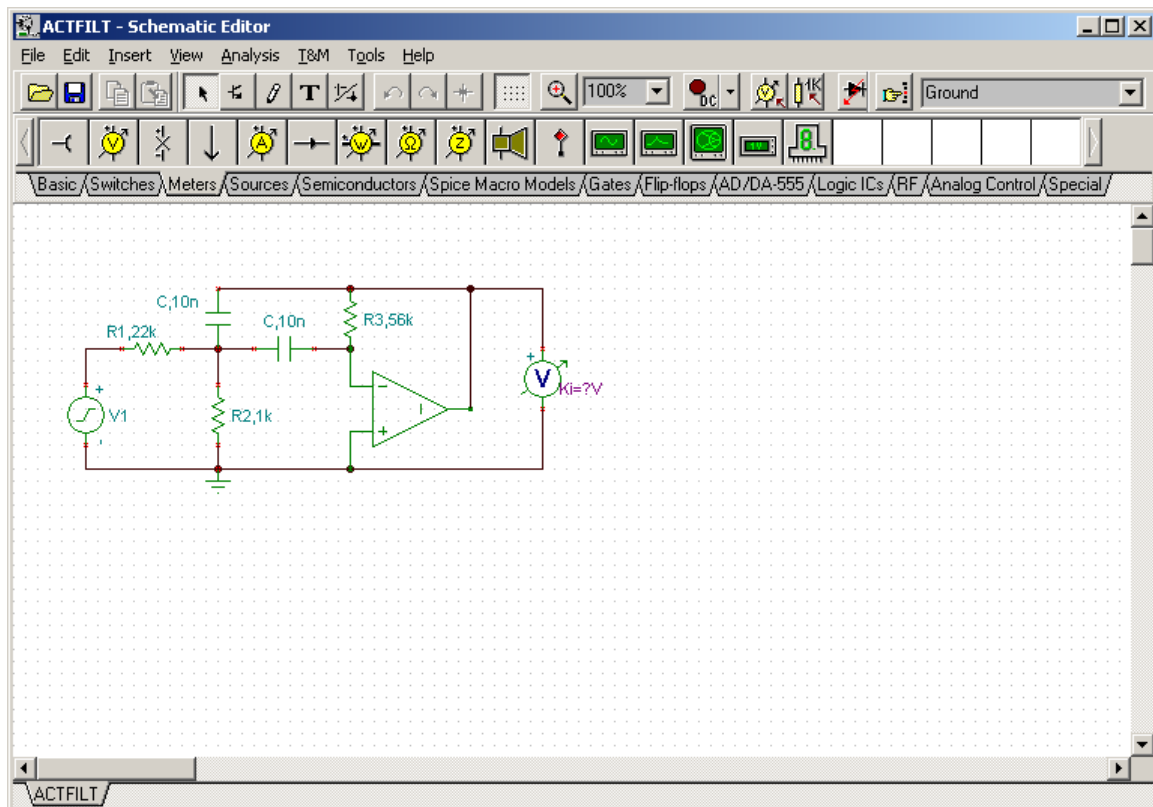

Now run Analysis.Symbolic Analysis.AC Transfer. The transfer function is generated and displayed in the Equation Editor.

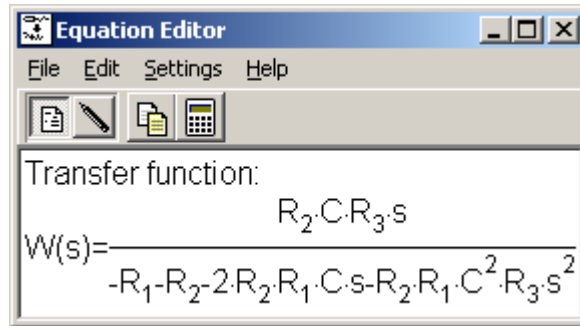

The screenshot shows a window titled "Equation Editor" with a menu bar (File, Edit, Settings, Help) and a toolbar. The main text area contains the following text:

Transfer function:  
$$W(s) = \frac{R_2 \cdot C \cdot R_3 \cdot s}{-R_1 - R_2 - 2 \cdot R_2 \cdot R_1 \cdot C \cdot s - R_2 \cdot R_1 \cdot C^2 \cdot R_3 \cdot s^2}$$

All the variables (values of the capacitors, resistors, etc...) were treated as (unknown) symbols, so the expression contains their symbolic names. However, in case you want to calculate the numerical form of the transfer function using the circuit element's actual values, you need to click on Analysis.Symbolic Analysis.Semi-symbolic AC Transfer, and the following expression will appear.

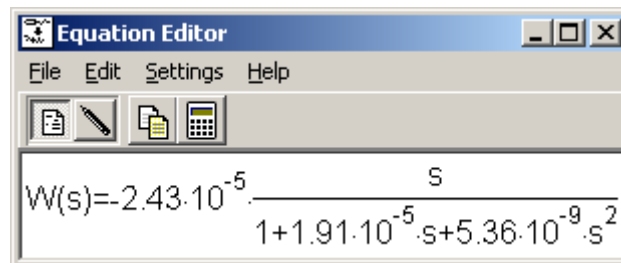

The screenshot shows the same "Equation Editor" window. The main text area now contains the following numerical expression:

$$W(s) = -2.43 \cdot 10^{-5} \cdot \frac{s}{1 + 1.91 \cdot 10^{-5} \cdot s + 5.36 \cdot 10^{-9} \cdot s^2}$$

This expression can then be copied to the clipboard (by pressing the copy button on the toolbar) and pasted to the schematic editor or to any of the diagram pages.

## Symbolic Analysis

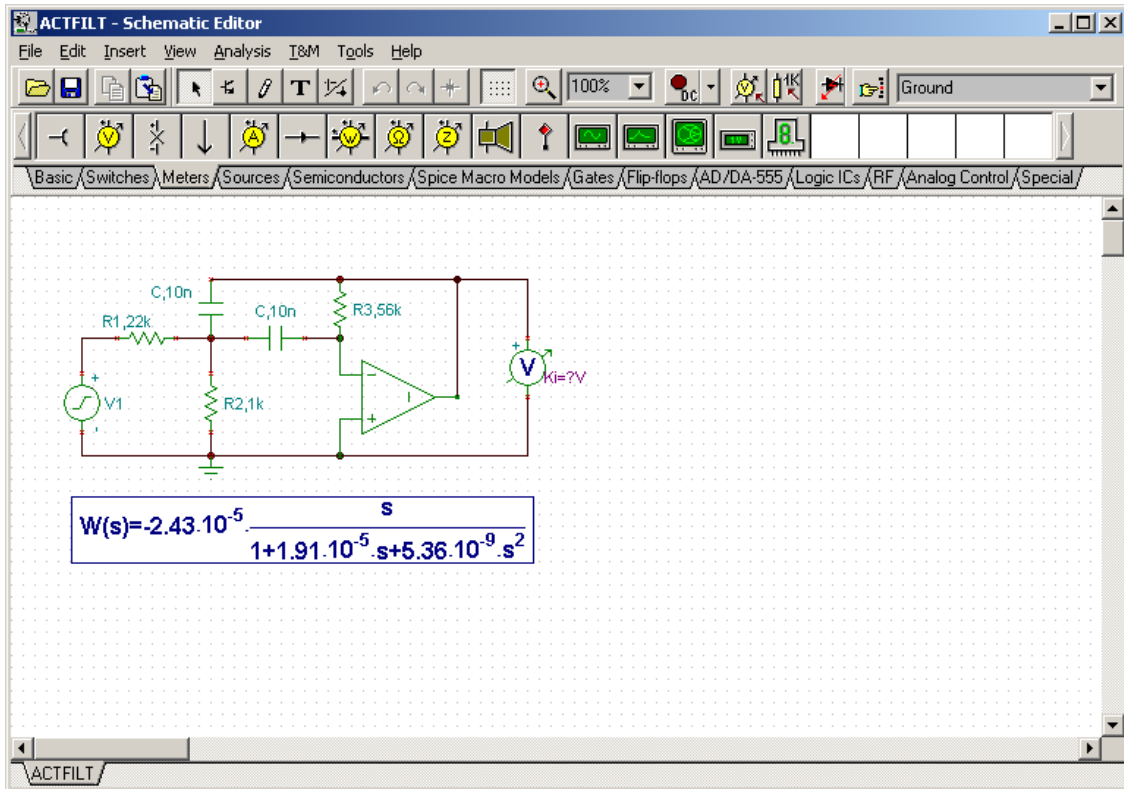

You can also generate a symbolic result with only a few symbolic variables, while the numerical values of the rest of the variables have been substituted. Symbolic analysis takes the symbols of the variable from the circuit element's *labels* in the schematic editor. When the label is empty or has been determined to not be a valid symbol name, symbolic analysis uses the part's numerical *value*. For example, if you change the label of the resistor R1 to "22k" or to "R1=22k", then the value of the part (22k) will be used in place of the symbol R1.

The Equation Editor window displays the following transfer function:

$$W(s) = \frac{R_2 \cdot C \cdot R_3 \cdot s}{-2.2 \cdot 10^4 - R_2 - 4.4 \cdot 10^4 \cdot R_2 \cdot C \cdot s - 2.2 \cdot 10^4 \cdot R_2 \cdot C^2 \cdot R_3 \cdot s^2}$$

TINA goes beyond simply presenting the function as an equation. Any of these functions can also be interpreted and drawn in the diagram window. To demonstrate this, let's first generate the transient response of an RLC series resonant circuit. Load the examples\symbolic\myrlc1.sch circuit into the schematic editor.



## Symbolic Analysis

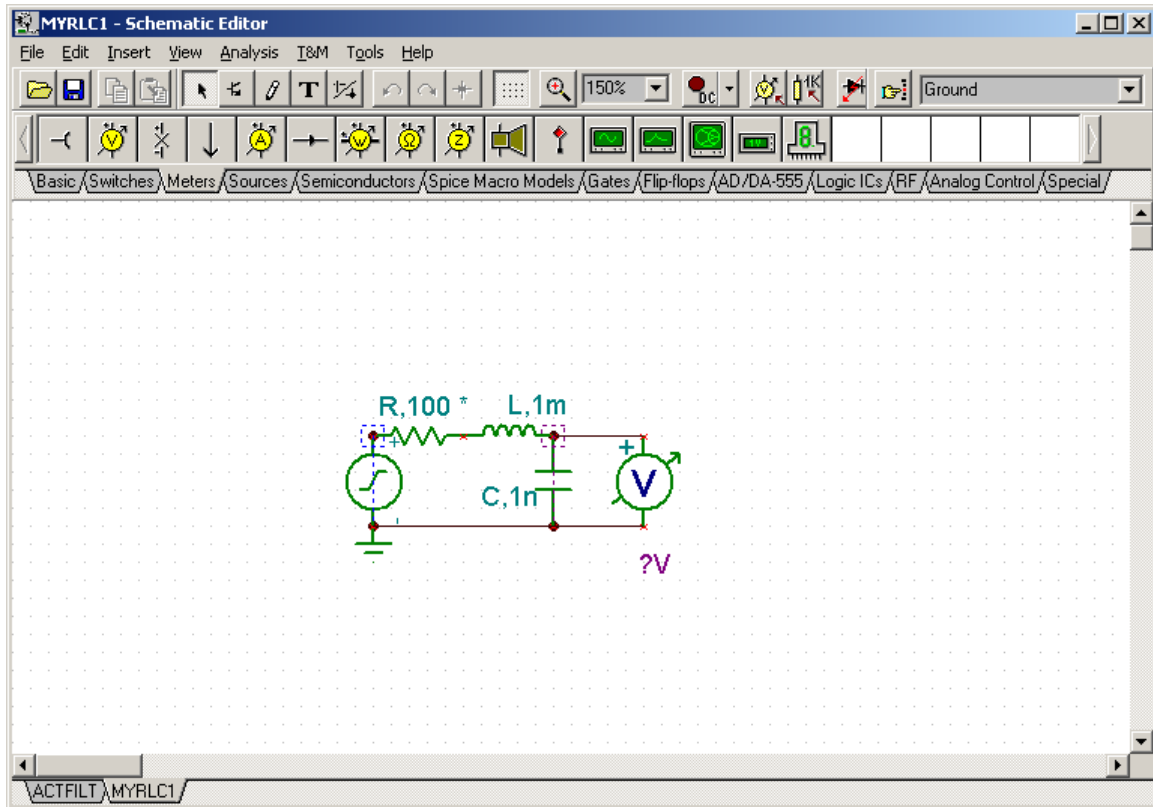

Next, run Analysis.Symbolic Analysis.Semi-symbolic Transient. The transient response of this circuit to a voltage generator with Unit step waveform is then the following:

The screenshot shows the Equation Editor window. The title bar reads 'Equation Editor'. The menu bar includes 'File', 'Edit', 'Settings', and 'Help'. The toolbar contains icons for file operations and a calculator. The main text area displays the transient response result: 'TR Result: v(t) = (1 + 1.e<sup>-5.10<sup>4</sup> t</sup> · cos(9.99 · 10<sup>5</sup> t - 182.87°)) · ε(t)'. The window has standard Windows window controls (minimize, maximize, close) in the top right corner.

Now press the small calculator (interpreter) button on the toolbar. The interpreter window appears, and our transient function is already defined as a v\_1 function.

## Symbolic Analysis

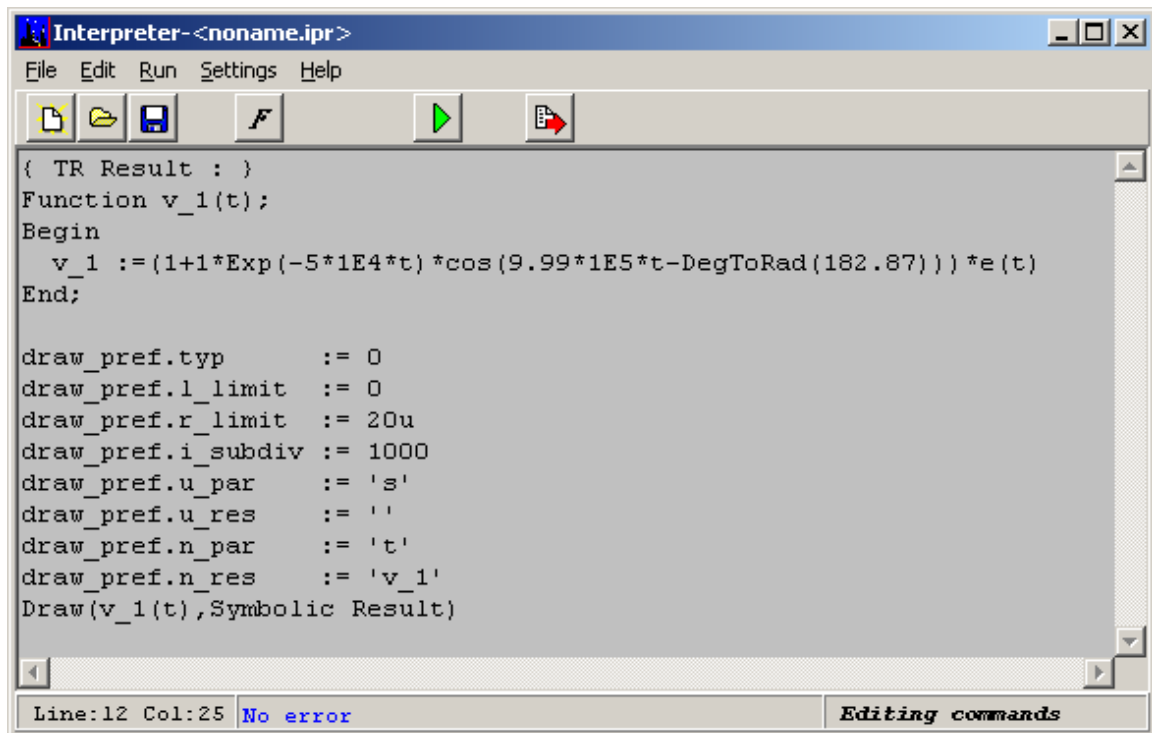

```
Interpreter-<noname.ipr>
File Edit Run Settings Help
[Icons: File, Folder, Save, Find, Run, Print]
{ TR Result : }
Function v_1(t);
Begin
  v_1 := (1+1*Exp(-5*1E4*t) *cos(9.99*1E5*t-DegToRad(182.87))) *e(t)
End;

draw_pref.typ      := 0
draw_pref.l_limit  := 0
draw_pref.r_limit  := 20u
draw_pref.i_subdiv := 1000
draw_pref.u_par    := 's'
draw_pref.u_res    := ''
draw_pref.n_par    := 't'
draw_pref.n_res    := 'v_1'
Draw(v_1(t),Symbolic Result)

Line:12 Col:25 No error Editing commands
```

As you can see, the function definition is followed by a few drawing preference settings, where you can define the ranges of the function and the number of points at which the function will be calculated. Finally, the last command draws this function in the diagram window. The second parameter of the draw command defines the name of our newly generated function. After pressing the  Run button, the function appears in the diagram window.

## Symbolic Analysis

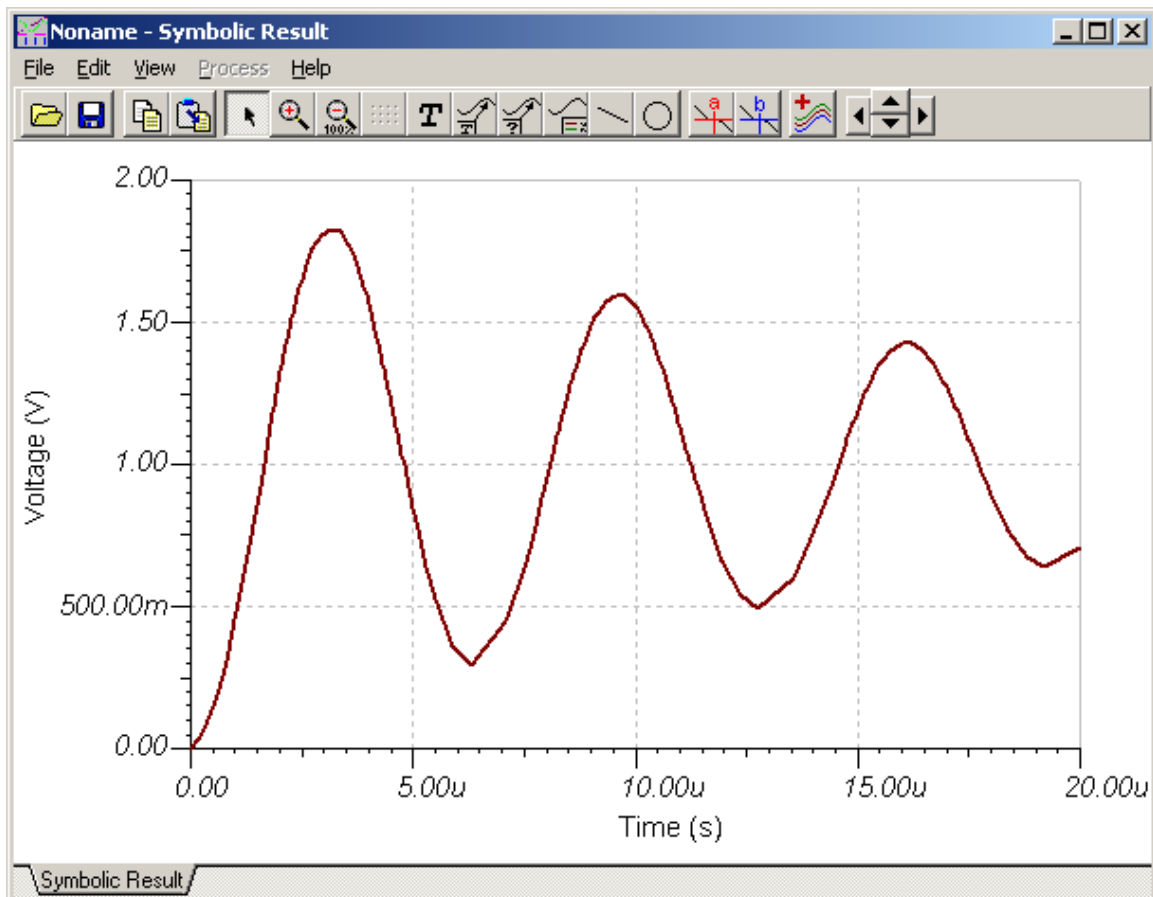

Symbolic analysis can also calculate the DC and AC results (response) of a linear network containing one or more sources. Just as with symbolic analysis of AC transfer functions, these results can be generated both in symbolic and semi-symbolic form. If we choose the symbolic form, all variables in the circuit that have symbolic identifiers (labels) will be treated as pure symbols. If we choose the semi-symbolic form, every parameter of the circuit will be handled as a number. When the circuit contains more than one generator (source), the result due to each of these generators will be calculated and added together (using the superposition law).

Let's use a simple parallel resistor circuit to get to know symbolic analysis of circuit results. Open the circuit examples\symbolic\suppos.sch.

## Symbolic Analysis

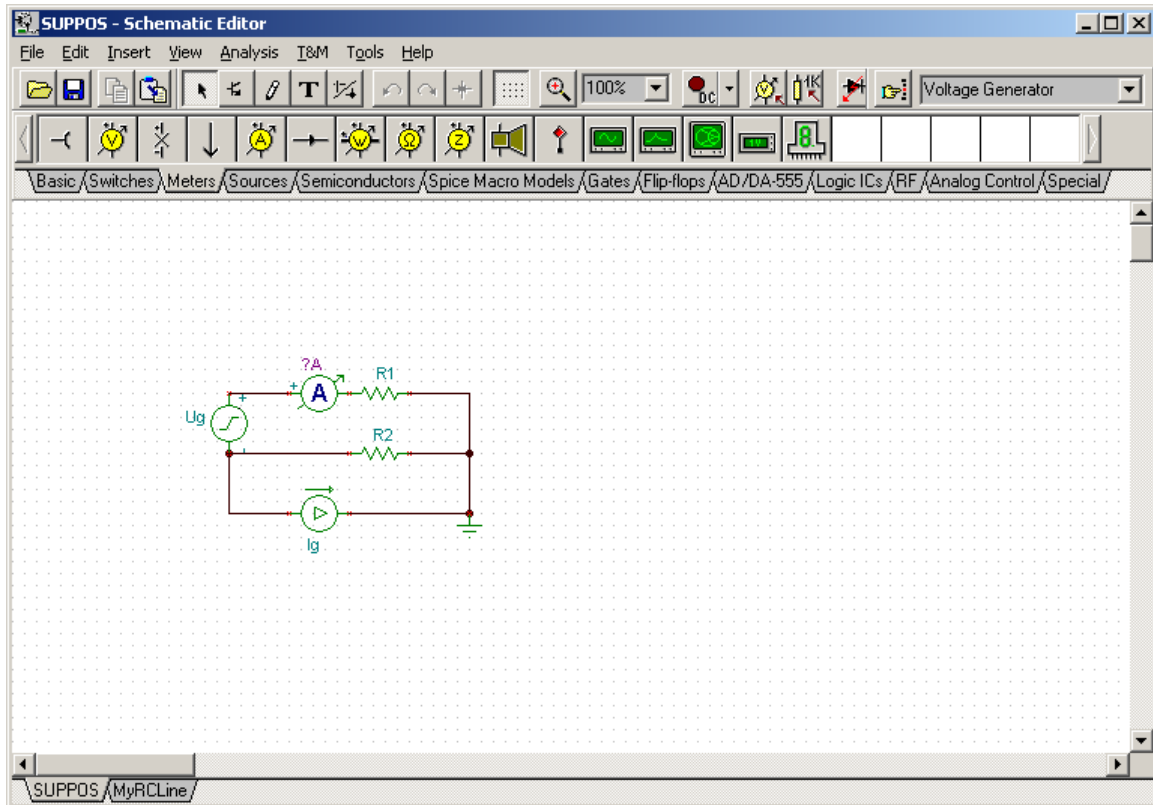

This circuit contains two generators: a voltage and a current generator. Now press Analysis.Symbolic Analysis.DC Result.

The Equation Editor window displays the following equation for the DC result:

$$I = \frac{R_2}{-R_2 - R_1} \cdot I_{gdc} + \frac{1}{R_2 + R_1} \cdot U_{gdc}$$

As you can see the result is a fully symbolic combination of the circuit's response to each of the generators.

Now press Analysis.Symbolic Analysis.Semi-symbolic DC Result.

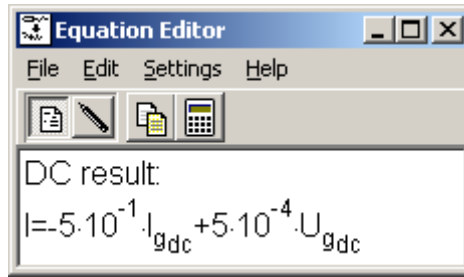

The screenshot shows a window titled "Equation Editor" with a menu bar (File, Edit, Settings, Help) and a toolbar with icons for file operations and calculation. The main text area contains the following text:

DC result:  
 $I = -5 \cdot 10^{-1} \cdot I_{gdc} + 5 \cdot 10^{-4} \cdot U_{gdc}$

In this Semi-symbolic DC Result, the coefficients of  $I_{gdc}$  and  $U_{gdc}$  are calculated numerically. Of course, this requires that R1 and R2 be assigned both a label and a numerical value.

### Hierarchical Semi-symbolic Analysis

Depending on the circuit size and topology, the symbolic result of an average circuit can easily become a huge, complicated expression. This is especially true for circuits that contain components whose models contain further symbolic components, such as transistors.

The symbolic expressions can be simplified by identifying parts of the circuit that are less important, or whose effect are already better understood, and setting only numeric values (no entry in the label field) for these components. For other components that are more important, be sure to enter a label so that they will be treated symbolically in the analysis. For visual convenience you can use TINA's advanced macro feature to create two different macros for each of the component you would like to examine in detail: one with a symbolic model and another with a purely numeric model. To demonstrate this feature, let's create an RC transmission line where some of the RC sections are numeric and others are symbolic. The numeric macro will look this.

# Symbolic Analysis

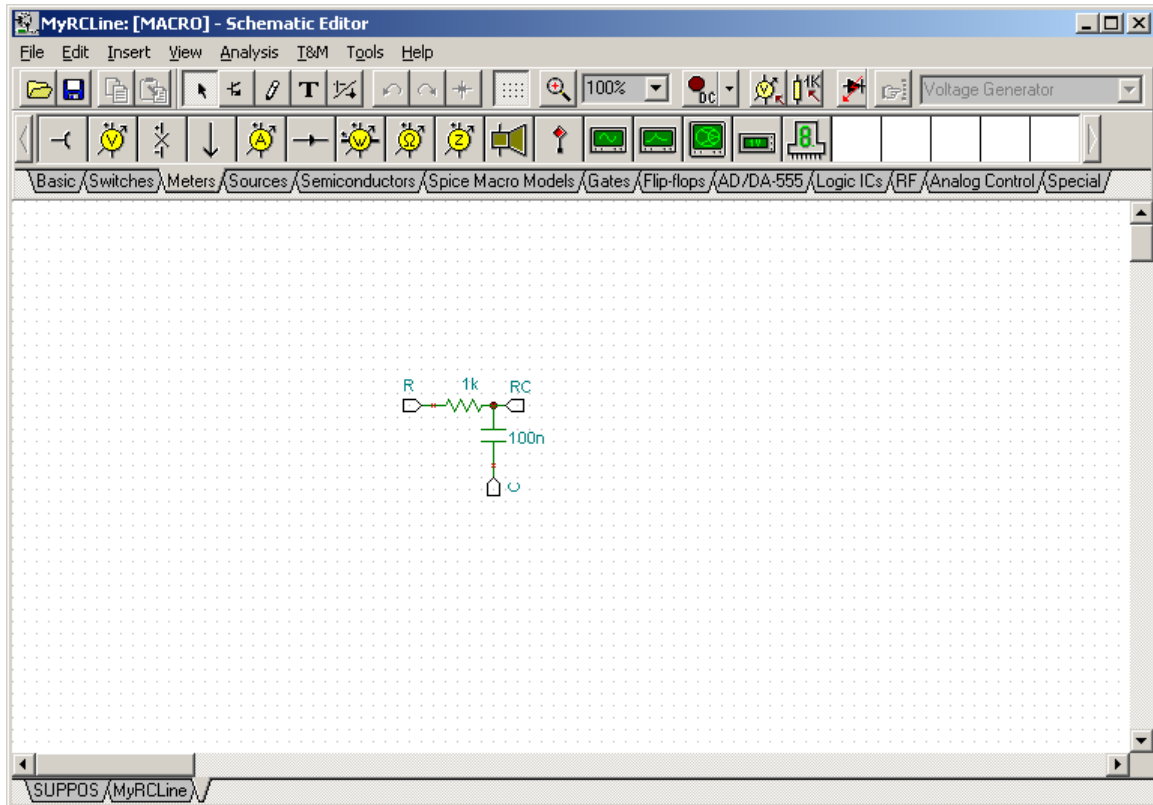

The resistor is 1k Ohm, and the capacitor is 100nF.

The symbolic model (below) has the same topology, but has symbolic R and C parameters.

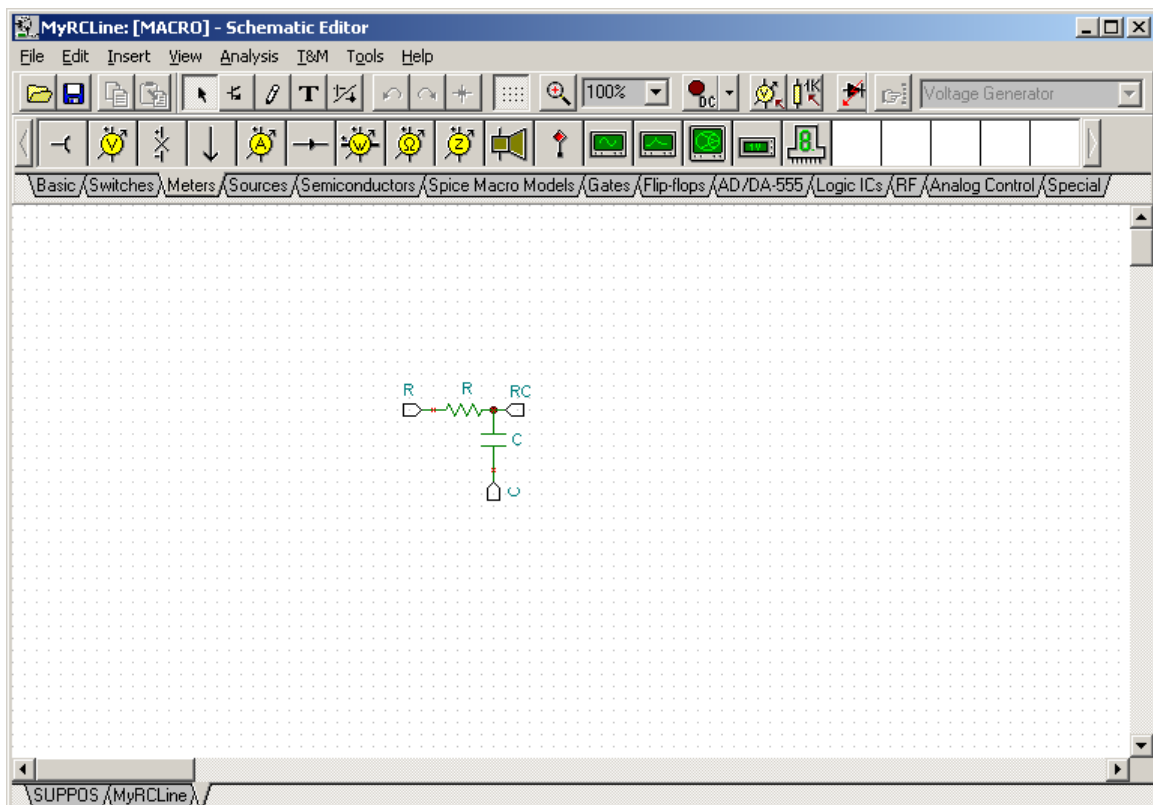

## Symbolic Analysis

Now let's consider an RC transmission line circuit with three RC sections. Only the middle section is numeric.

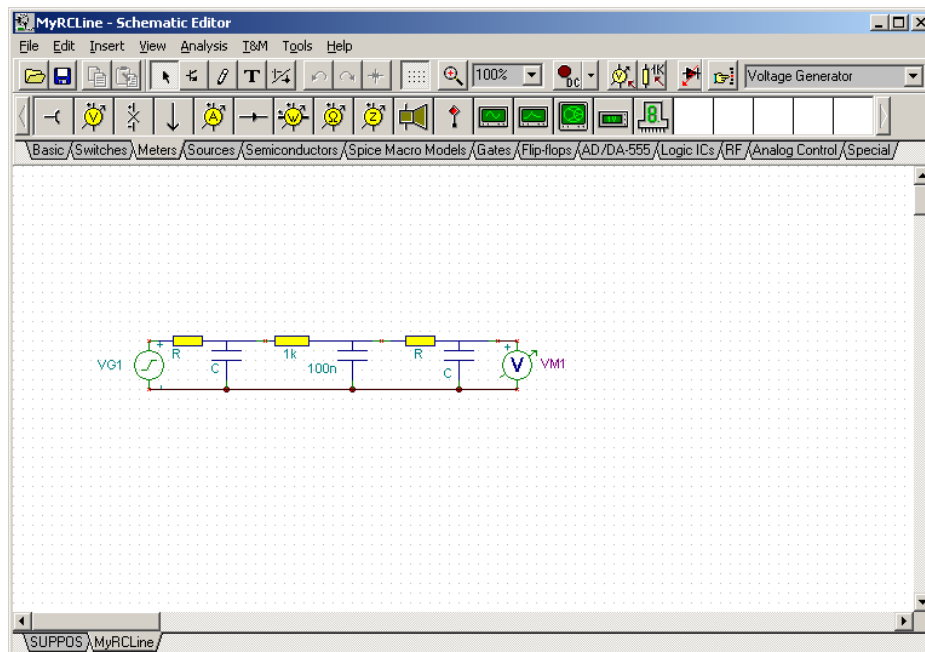

Pressing Analysis.Symbolic Analysis. AC Transfer, TINA calculates the result:

The screenshot shows the Equation Editor window. The transfer function is displayed as follows:

$$W(s) = \frac{10 \cdot 10^6}{10 \cdot 10^6 + (R + 3 \cdot 10^7 \cdot C \cdot R + 1000 + 10 \cdot 10^9 \cdot C) \cdot s + (R + 10 \cdot 10^6 \cdot C \cdot R + 2000 + 10 \cdot 10^9 \cdot C) \cdot C \cdot R \cdot s^2 + 1000 \cdot C^2 \cdot R^2 \cdot s^3}$$

If we change the position of the numeric section of our circuit (by simply dragging the whole macro to its new position), we see:

## Symbolic Analysis

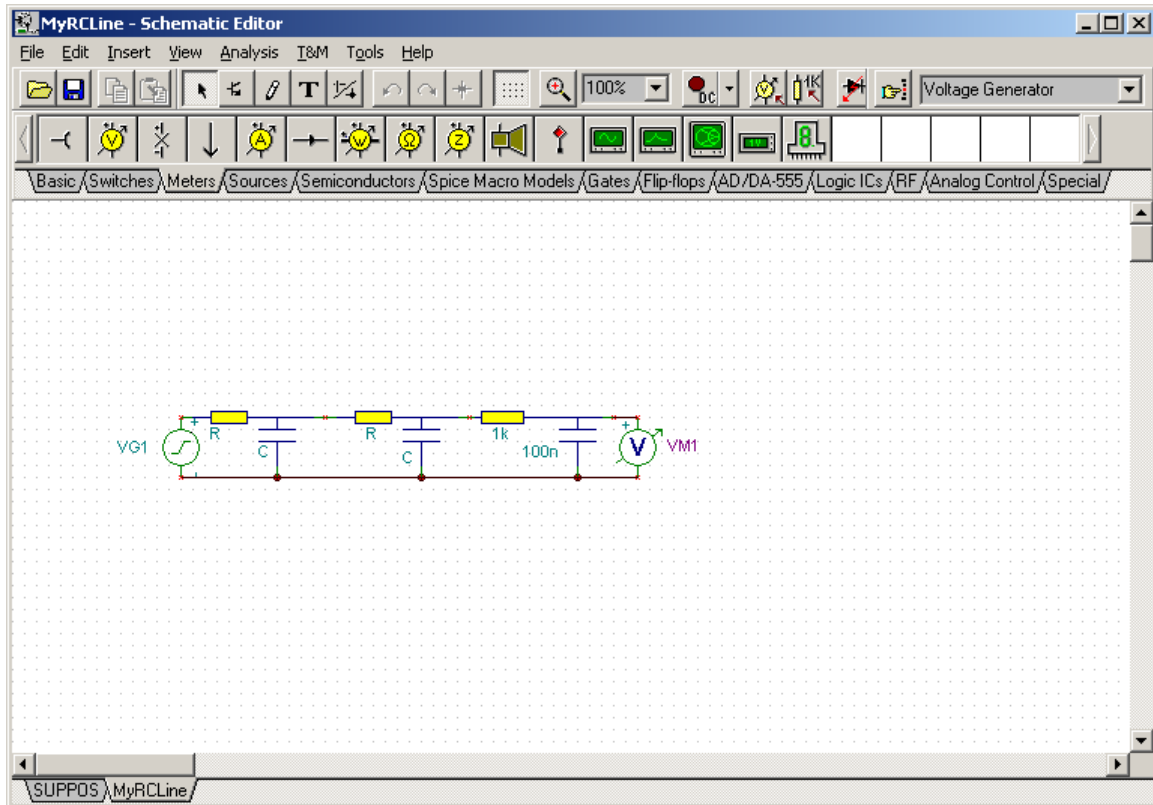

And the result changes as well:

The screenshot shows the Equation Editor window. The transfer function is displayed as follows:

$$W(s) = \frac{10 \cdot 10^6}{10 \cdot 10^6 + (3 \cdot 10^7 \cdot C \cdot R + 2 \cdot R + 1000) \cdot s + (3000 + R + 10 \cdot 10^6 \cdot C \cdot R) \cdot C \cdot R \cdot s^2 + 1000 \cdot C^2 \cdot R^2 \cdot s^3}$$

Note that TINA's built in transistor models are purely symbolic: i.e., the bipolar transistor contains a base resistor and a current controlled voltage source, while the MOS and JFET contain a drain-source resistance and a voltage controlled current source. If you want to calculate the DC or AC symbolic transfer or result function of a circuit with several transistors, you can simplify the expressions by creating your own transistor models using only numeric components.



# Post-processing Analysis Results

## Adding new curves to diagrams and post-processing analysis curves

TINA has a great tool to add new curves of virtually any node and component voltage or currents. In addition, you can post process existing curves by adding or subtracting curves, or by applying mathematical functions. You can also draw trajectories; i.e., draw any voltage or current as a function of another voltage or current.

If you check “Save all analysis results” in the Analysis.Options dialog, TINA will calculate and store all the results that are reasonable in the current circuit. However, only those results that have been set as output are inserted automatically into the diagram window.

To add these curves, or to add new, user-defined curves to a diagram, press the *Add more curves* button  on the toolbar or call the *Add more curves* menu in the Edit menu. The post-processing dialog appears on the screen.

This dialog box consists of two parts: in the upper part you can select and insert/remove existing curves into/from the current diagram, while in the lower part you can define your own curves. The lower part of the dialog box is hidden by default. Press the “More >>” button if you want to create new curves.

### Upper part:

When this dialog first opens, the *Available curves* list box contains all the curves that have already been calculated. The status bar shows the circuit file name and the analysis which was run. You can select and add any of the curves into the *Curves to insert* list box by selecting them in the *Available curves* list and pressing “Add>>”. Similarly, you can move back any curves from the *Curves to insert* listbox into the *Available curves* list box by selecting them and

## Post-processing Analysis Results

---

pressing <<Remove. To make selection easier, you can filter out some of the available curves by unchecking any of the *Show* types. When you press OK, all the curves in the *Curves to insert* list box will be inserted into the active diagram page.

TINA offers another way to select curves for inclusion in the diagram. With the Post processing dialog box open, move the cursor over the schematic. The cursor will change into a pencil shape. Move it over a node or circuit component in the schematic and click. The corresponding curve will be selected in the Available Curves list, and you can add it to the diagram by clicking the Add>> button.

Selected curves can also be deleted with the Delete button. Deleted curves will be removed both from the list boxes and from the dialog window pages!

### Lower part:

This part is hidden by default. If you want to create new curves, press the “More >>” button.

Here you can define your own curves using arithmetic operators and mathematical functions. These custom curves must be defined either as a single-line mathematical expression or as a Pascal-like function.

Take special care if you transform the independent variable of curves; for example, writing  $v(t+1)$  instead of  $v(t)$ . The transformed variable expects results from beyond the interval for which the calculation was run. TINA in this case would have no choice but to set the new curve to zero outside of the calculated interval.

While single-line expressions can be entered in the *Line Edit* field, more complex functions should be defined in the *Advanced Edit* field. The *Advanced Edit* checkbox enables/disables the *Advanced Edit* field.

## Post-processing Analysis Results

---

Pressing the  “Add to edit area” button above the *Line Edit* field, you can insert the currently selected curve from the *Available curves* list into the editor field.

Pressing the  “Add to edit area” button to the right of the Built-in Functions drop down list, you can insert the currently selected function from the Built-in Functions list into the editor field.

You can also display a result as a function of another result (e.g.,  $v(t)$  as a function of  $i(t)$ ) using the *XY Plot* checkbox. If you check this box, the Line Edit field is divided into an X-part and a Y-part. Bring the curve names into the two fields using the  “Add to Edit-area” button or type the curve names. You can use several curves, arithmetic operations, and functions—but you cannot use *Advanced Edit* in this mode.

You can use the “*New function name*” edit field to enter your name for the new function (curve).

After you have completed the definition, you can either draw your new curve directly into the diagram window by pressing *Preview*, or you can first store the result by pressing *Create*, and then insert it with the OK button.

Now let’s run a transient analysis on the AmpliOpt circuit in the *EXAMPLES* directory. Two curves are drawn in the diagram window: the input,  $V_{in}$ , and the collector voltage,  $V_{out}$ .

## Post-processing Analysis Results

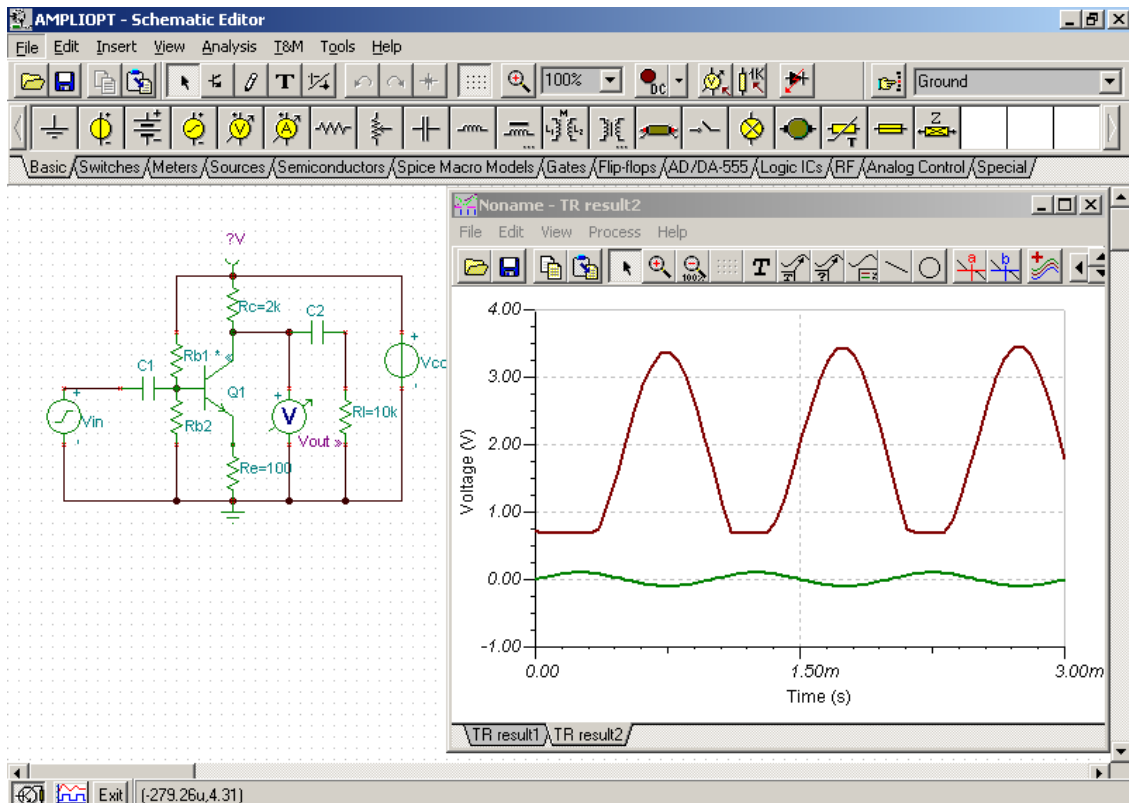

Now press the *Add more curves button* on the toolbar. The post-processing dialog appears. The *available curves* listbox on the left side shows all the curves that have already been calculated.

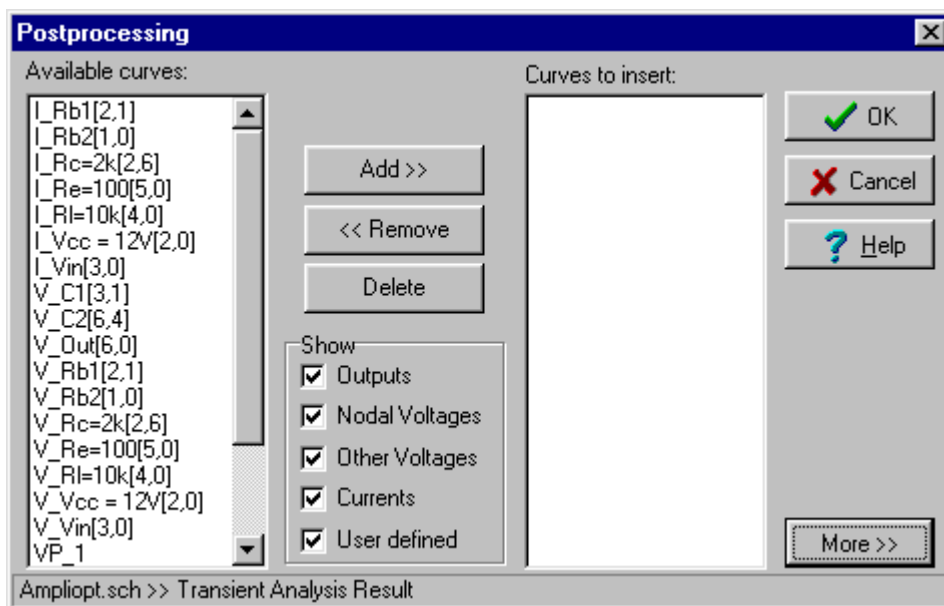

## Post-processing Analysis Results

---

Here, the symbols  $V_{label[i,j]}$  and  $I_{label[i,j]}$  denote the voltages and currents respectively of the *labeled* components between the node  $i$  and  $j$ . The symbol  $VP_n$  denotes the nodal voltage of the node  $n$ .

Now, select  $V_{C2[6,4]}$  (i.e., the voltage of capacitor C2 connected between node 6 and 4) and press the Add>> button. Pressing OK inserts this curve into the current diagram page.

As the next step, let's draw the voltage across the transistor's collector and emitter. Press the *Add more curves* button again and then press the More>> button to reveal the lower part of the diagram. Type  $VP_6-VP_5$  in the *Line edit* field.

*Note:* another, perhaps easier way, to insert  $VP_6$  or  $VP_5$  into the Edit field is to move the cursor over Q1's collector or emitter, click, and press the  "Add to Edit-area" button below the listbox.

Note also that if you double click on any node in the circuit with the mouse, the corresponding nodal voltage symbol will be automatically inserted into the *Line edit* field at the current cursor position.

Now change the default name of our function to VCE and press Create.

## Post-processing Analysis Results

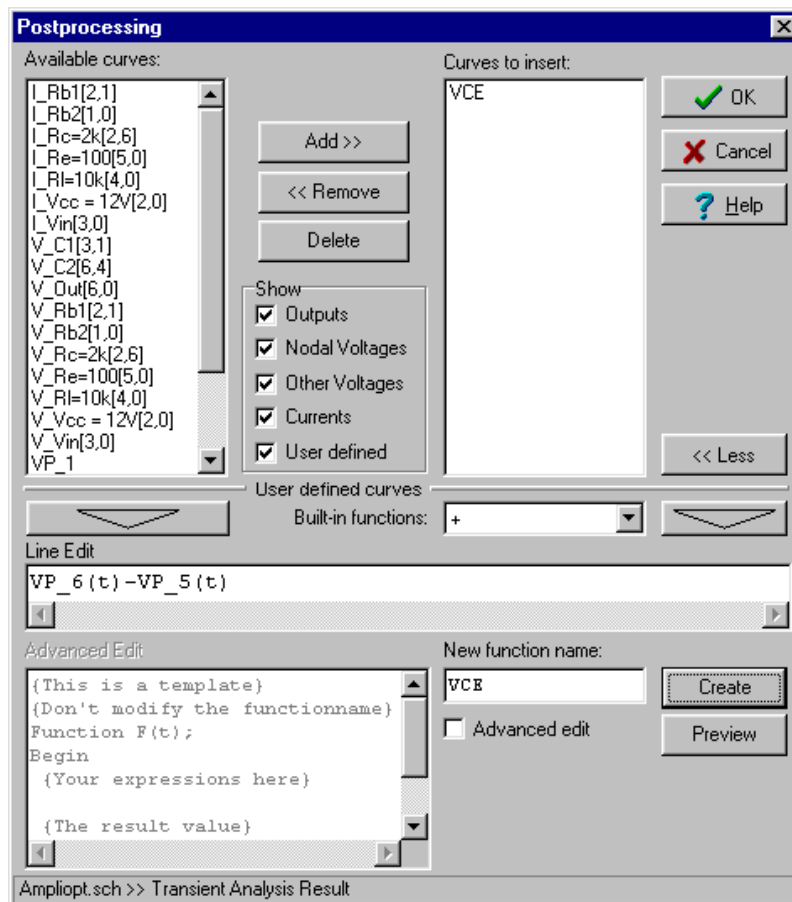

A new function (VCE) is created and inserted automatically into the *Curves to insert* listbox. If you press OK, our new curve will immediately appear on the diagram.

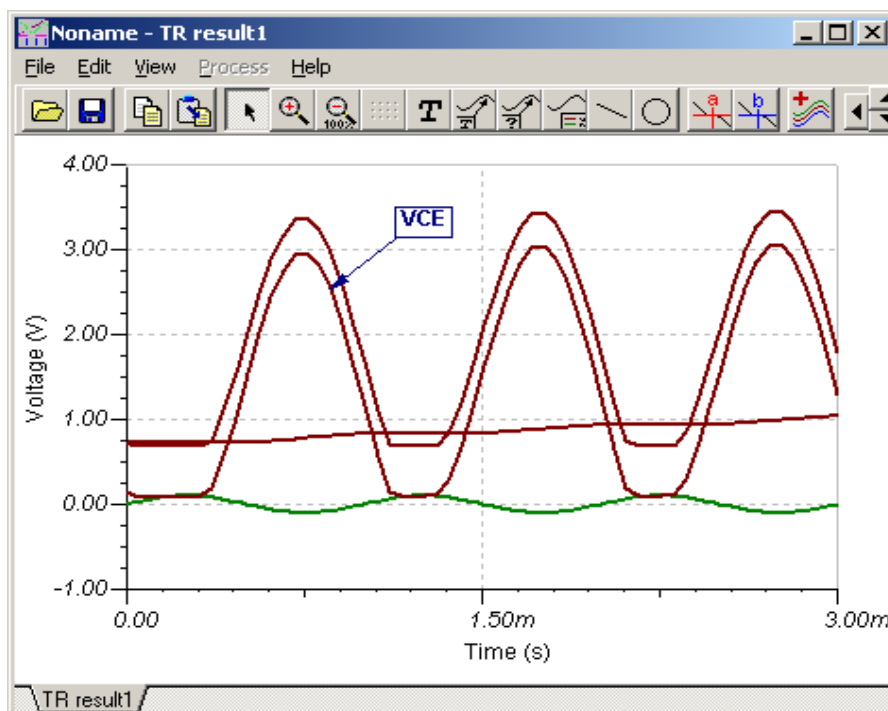

## Post-processing Analysis Results

---

Sometimes the definition of a new curve requires more editing space or other variables. In these cases we can use the post-processing dialog's *Advanced edit* field. To illustrate this, let's draw the output power dissipation of a differential amplifier.

Open the circuit called DiffAmp in the examples directory and run a transient analysis. Press *Add more curves* again and place a check in the *Advanced edit* field. Position the cursor in the *Advanced edit* field below the comment *{Your expressions here}*.

Type :

```
IR2 := I_R2[14,16](t);  
VCE := VP_15(t)-VP_3(t);
```

Change the line  $F := 1$ ; *{The result value}* to:

```
F := IR2*VCE;
```

Enter the name of our new function, OutDissipation, and press Create.

## Post-processing Analysis Results

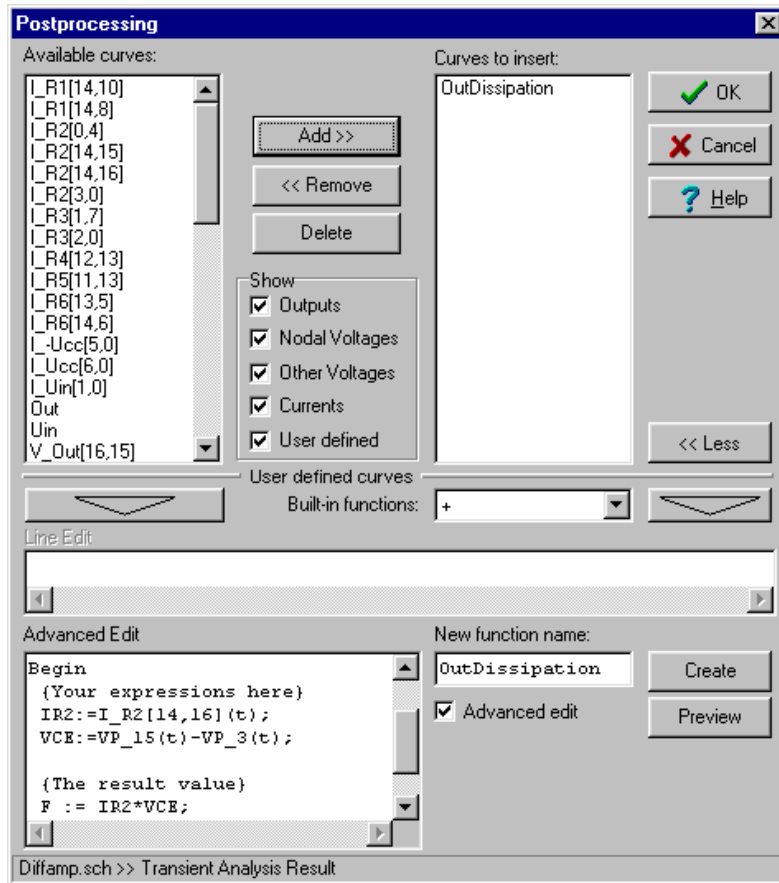

Finally, press OK to draw our new function in the diagram window.

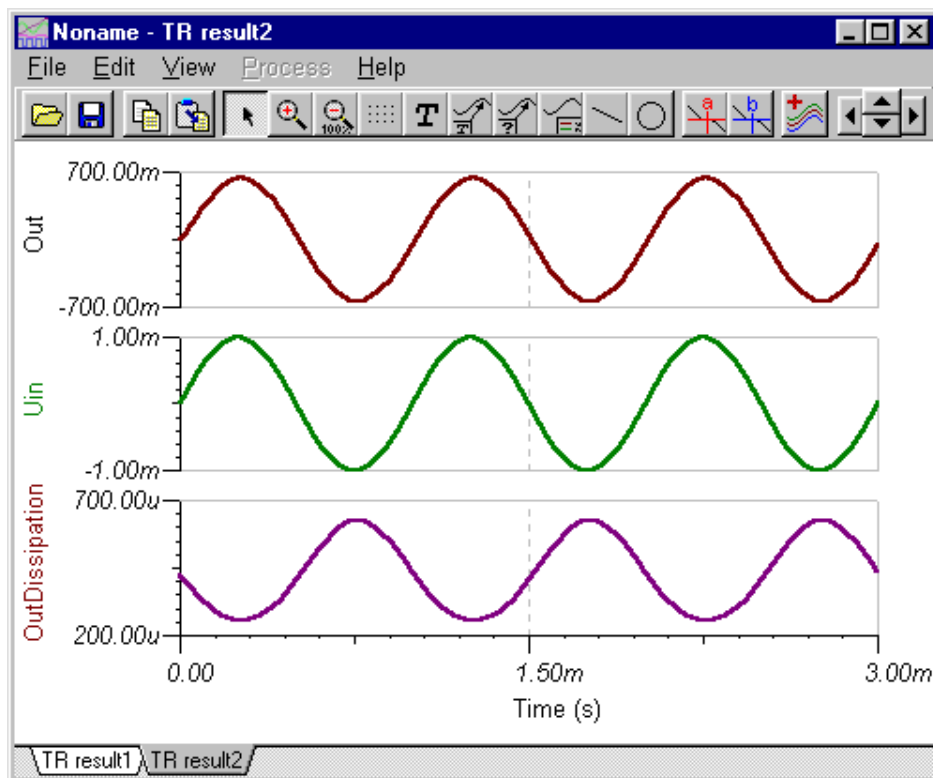



### Drawing trajectories (xy-plots) in TINA

In the Post-processor you can also display a signal as a function of another signal, by drawing XY-plots.

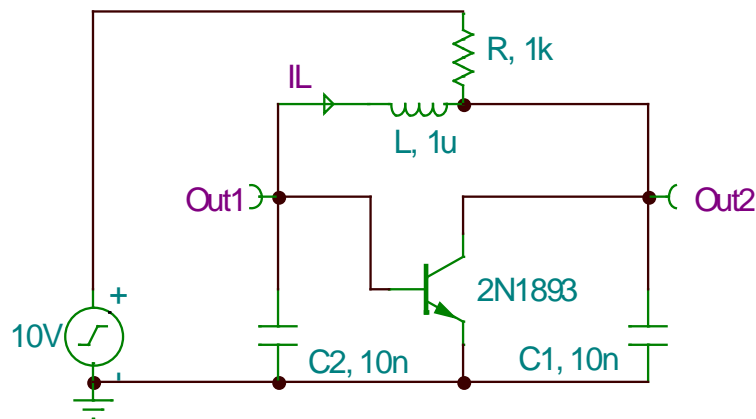



For example, let's draw the voltage of capacitor voltage Out2 as a function of the inductor current IL in the oscillator shown in the figure above.

First load the circuit `limitc.tsc` from the *EXAMPLES* directory. Run the Analysis.Transient analysis. Now the diagram window shows two curves, the capacitor voltage, out1, and the inductor current, IL.

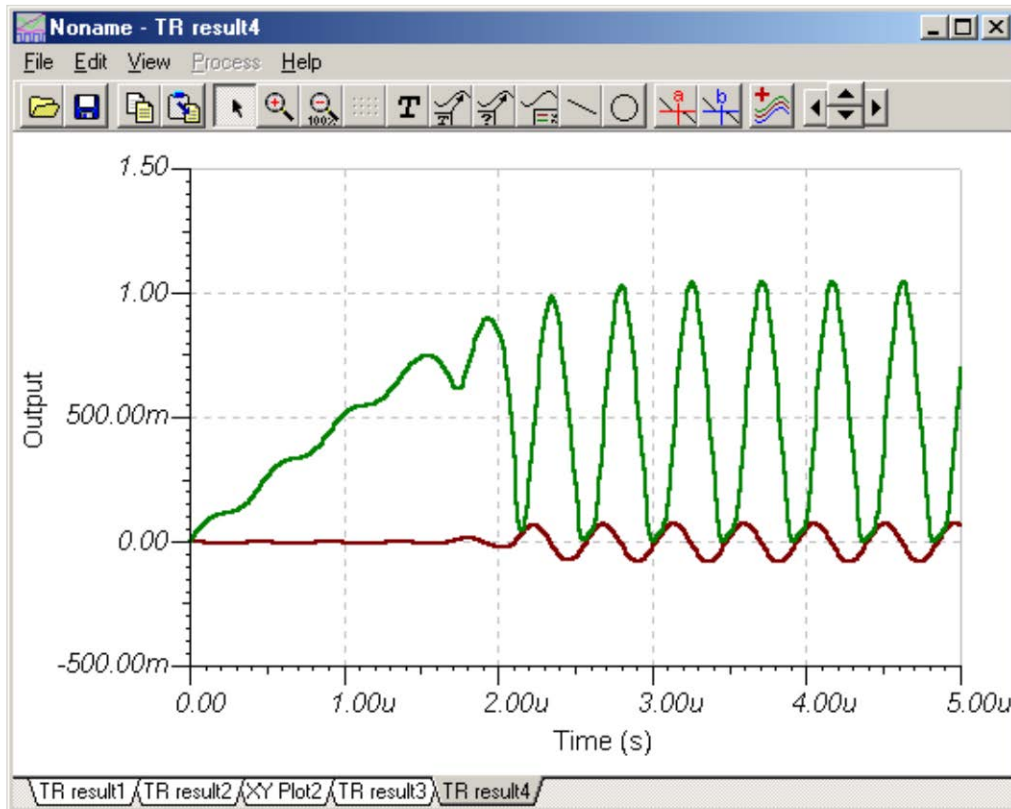
## Post-processing Analysis Results



Press the  *Add more curves* button and check the XY-plot checkbox. As you can see in the next figure, the line-edit section is divided into an X-part and a Y-part. Type Out2(t) in the X part and IL(t) in the Y part and press Create and OK. Alternatively, you could have brought the names into the two fields using the  "Add to Edit-area" button.

## Post-processing Analysis Results

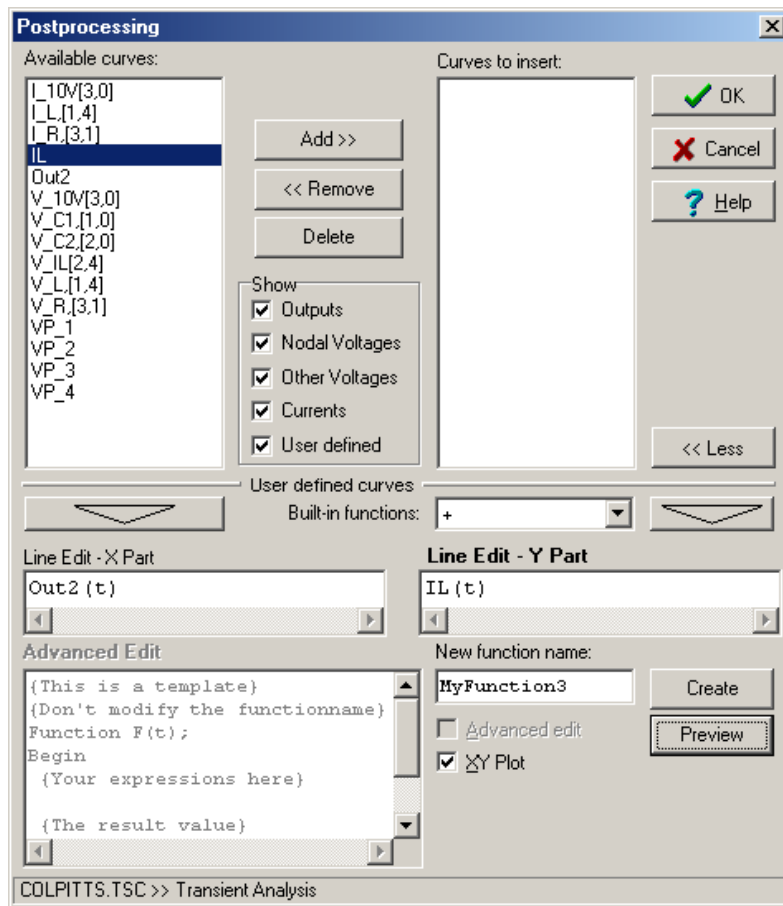

The calculated curve is shown in the next figure. Place a cursor on any curve and move the cursor. As the curve starts from the (0,0) point and converges to a closed trajectory, we see a “limit cycle.” Limit cycles are very important in the theory of oscillators.

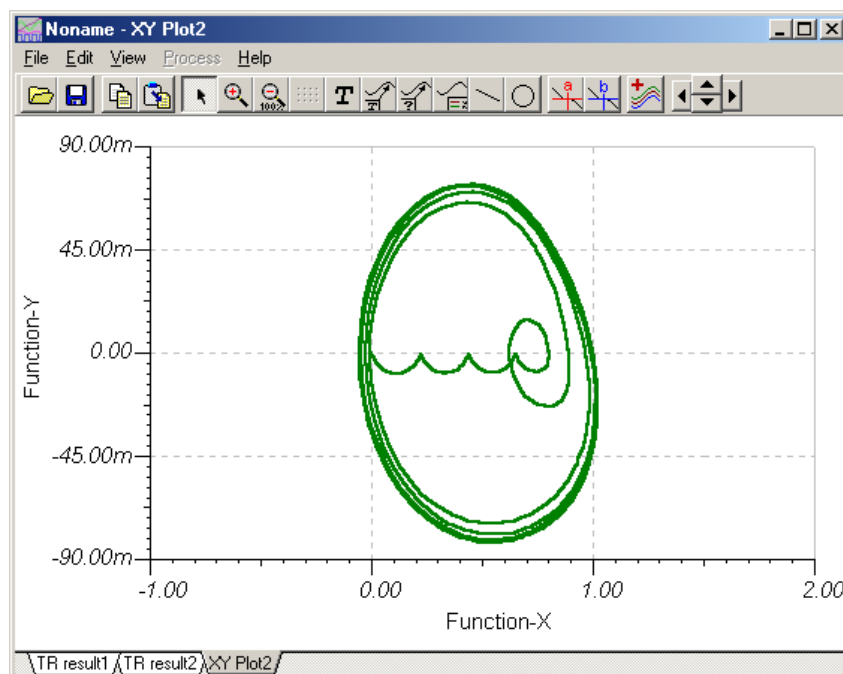

## Design Tool

TINA's Design Tool works with the design equations of your circuit to ensure that the specified inputs result in the specified output response. The tool requires of you a statement of inputs and outputs and the relationships among the component values. The tool offers you a solution engine that you can use to solve repetitively and accurately for various scenarios. The calculated component values are automatically set in place in the companion TINA schematic and you can check the result by simulation.

As an example, this tool can calculate feedback or other resistor and capacitor values of an amplifier in order to achieve a certain gain and bandwidth, and it can calculate component parameters of power supply circuits to meet output voltage and ripple requirements.

The TINA Design Tool promotes good documentation by storing the design procedure together with the circuit.

It is also very useful for semiconductor and other electronics component manufacturers to provide application circuits along with the design procedure.

Let's demonstrate the use of this tool through a simple operational amplifier example.

Open the Invert Gain OPA350 Test Circuit Design.TSC circuit from the Examples\Design Tool folder of TINA. In the TINA Schematic Editor the following circuit will appear:

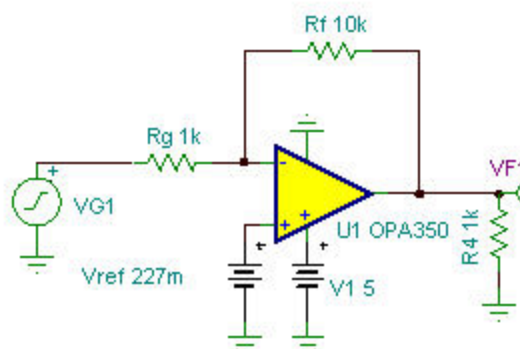

## Design Tool

---

With the Design Tool we will set  $R_f$  and  $V_{ref}$  to achieve the specified Gain and DC output voltage.

Now invoke the Design Tool from the Tools menu of TINA. The following dialog will appear.

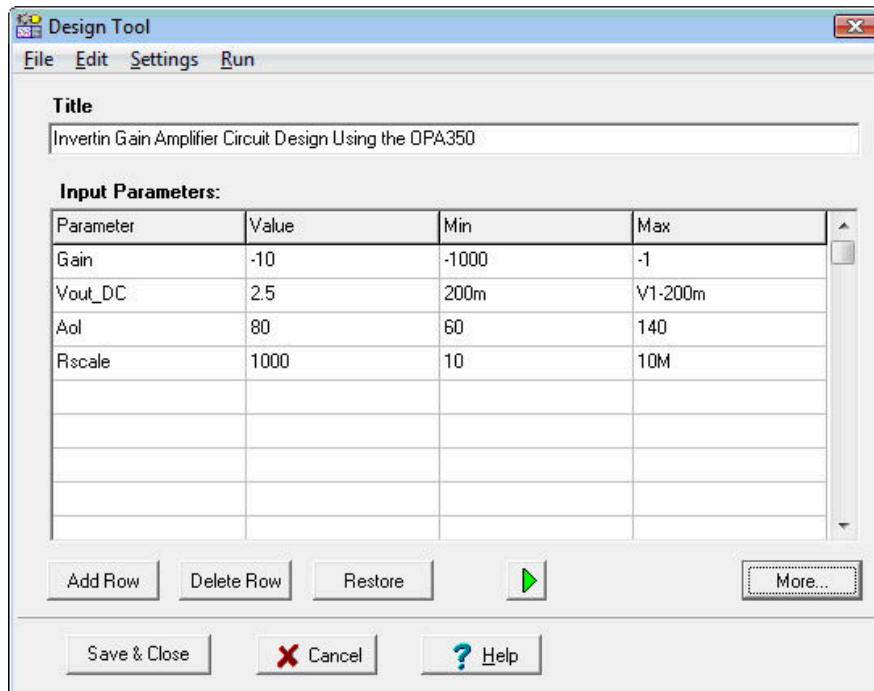

Here you can specify the Gain ( $V_{out}/V_{in}$ ), the DC output voltage ( $V_{out\_DC}$ ) and some other parameters. The simple design procedure will calculate  $R_g$  and  $V_{ref}$ . The allowed minimum (Min) and maximum (Max) parameters are also shown. To enable or disable modification of Min and Max select Options from the Settings menu of the Design Tool.

Note that in the Design Tool dialog you can also refer to component parameter names. For example in the  $V_{out\_DC}$  line the maximum value is set as  $V1-200m$ , telling that the DC output voltage must be at least by 200mV less than the  $V1$  supply voltage of the IC.

If you just want to Run the design procedure press the button or the F9 key or use the Run command in the menu of the tool. If you run TINA in interactive mode you can immediately see the effect of the changes made by the Design Tool.

## Design Tool

To see the design procedure itself, press the More button in the dialog. The code of the design procedure, written in TINA's Interpreter, will appear.

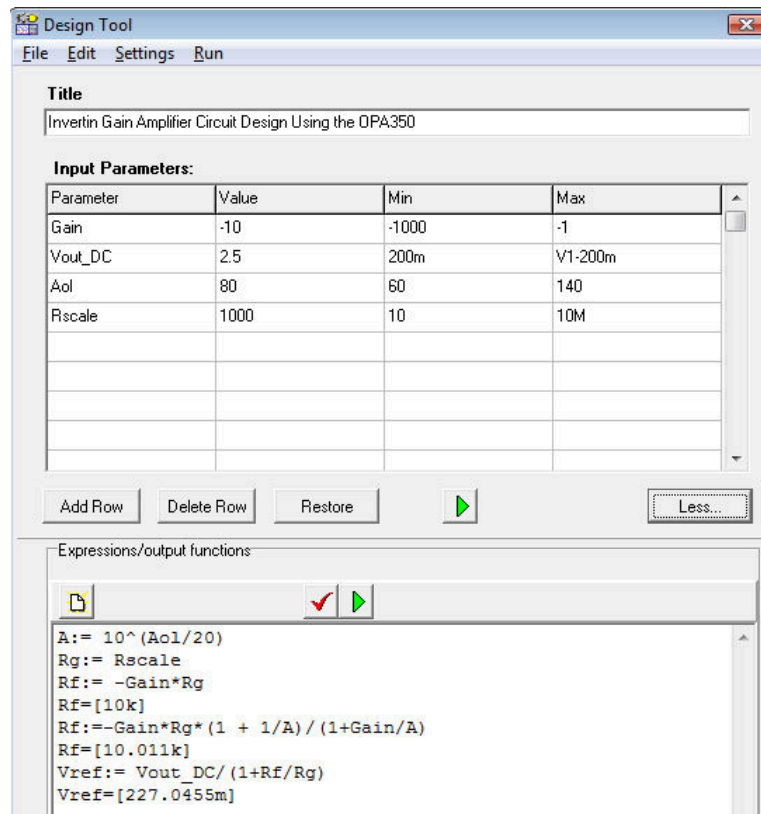

Note that the code part also shows the calculated parameter values according to the last stored calculation (Now  $R_f=[10.011k]$ ,  $V_{ref}=[227.0455m]$ ).

Now let's change the Gain input parameter to -1, Vout\_DC to 3V and run the procedure by clicking Run in the menu or pressing the green  button or F9 on the keyboard. In the code part we will see:

```
A:= 10^(Aol/20)
Rg:= Rscale
Rf:=-Gain*Rg*(1 + 1/A)/(1+Gain/A)
Rf=[1.0002k]
Vref:= Vout_DC/(1+Rf/Rg)
Vref=[1.4998]
```

## Design Tool

and the new values will immediately appear in the schematic editor, drawn in brown color. Press the DC button to display the DC output voltage:

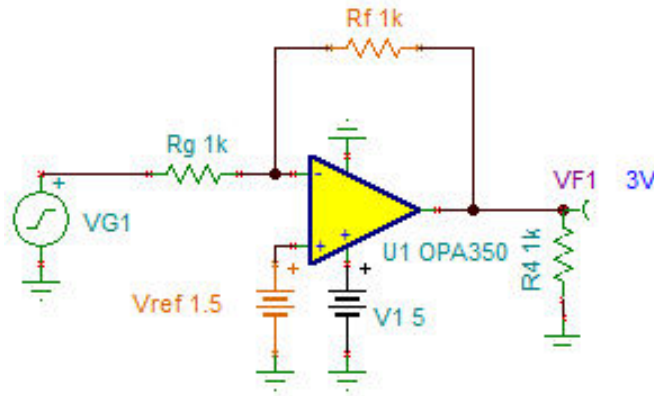

Now run an AC Transfer analysis, the Bode diagram will appear.

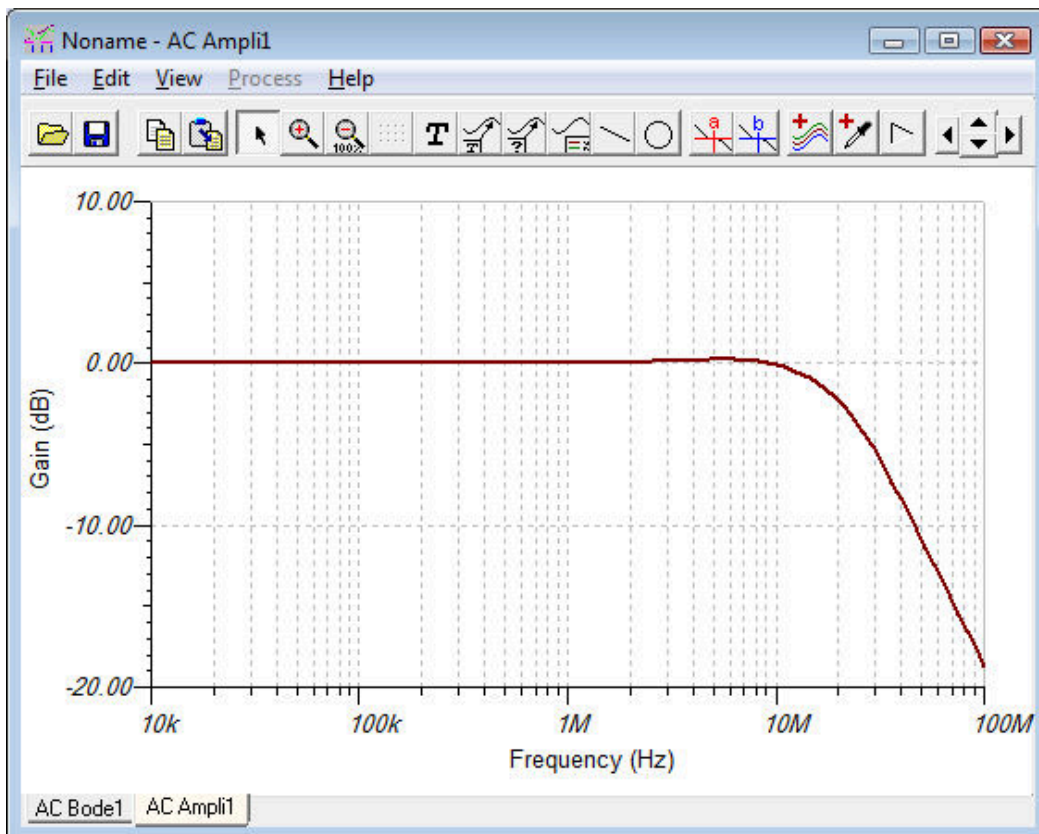

The small frequency Gain is 0dB which complies with the specified  $V_{out}/V_{in} = -1$  value.

## Design Tool

---

You can find more complex examples in the Design Tool folder of TINA.



You can make your own design procedure in any TINA circuits and save it together with the circuit itself.



For more information on the use and the controls see the on-line help in TINA by pressing the Help button on the tool.



## Optimization

TINA's optimization tool will determine for you one or more unknown circuit parameters (Control Object) which satisfy a predefined circuit target response (Optimization Target). The target circuit response (voltage, current, impedance, or power) must be "monitored" by a meter—or meters—previously inserted at the desired location(s). The unknown circuit parameter(s) will be determined automatically so that the circuit will produce the target output. Two alternative iterative methods (simple and pattern search) are used to find the optimum.

Use the commands Analysis.Control Object, Analysis.Optimization Target, or the speed buttons Select Control Object , Select Optimization Target  to set up Optimization mode or to change their settings.

First, place the voltage, current, impedance or power meter(s) onto the schematic to represent the Optimization Targets. Click on the Select Optimization Target speed button  or select the Analysis.Optimization Target menu item. A special cursor  will appear in the schematic editor window, waiting for you to identify the meter. Should you need more meters to represent the optimization targets, repeat the procedure above for the other meters.

There are several target functions you can choose depending upon the analysis mode of the optimization (DC or AC).

For DC optimization problems, you'll need DC goal functions. When you click on a meter with the special target selector  cursor, a dialog box appears showing several goal functions:

## Optimization

---

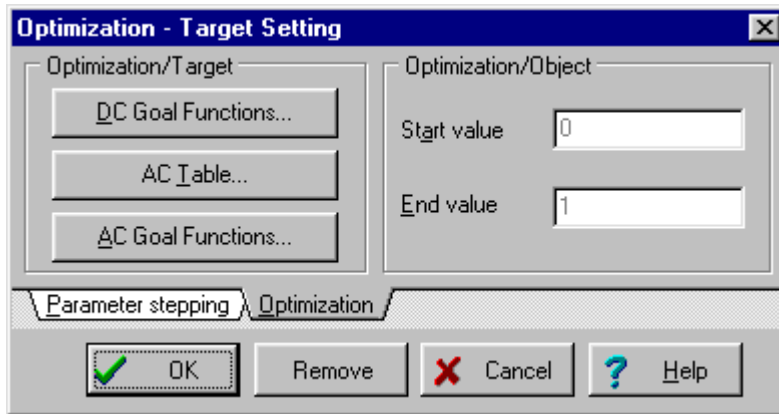

Click on the DC Goal Functions... button. Another dialog box appears which allows you to set a DC goal function:

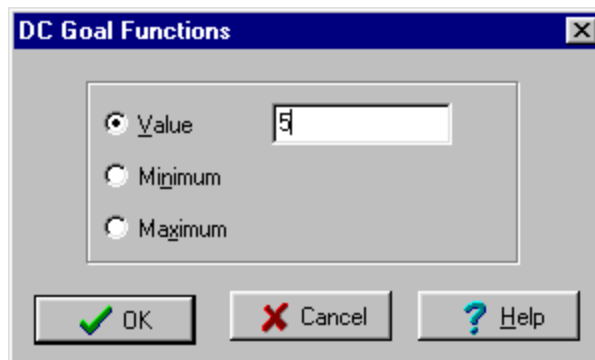

To optimize to a target Value, enter the desired value. To optimize to a Maximum or Minimum, select the appropriate option.

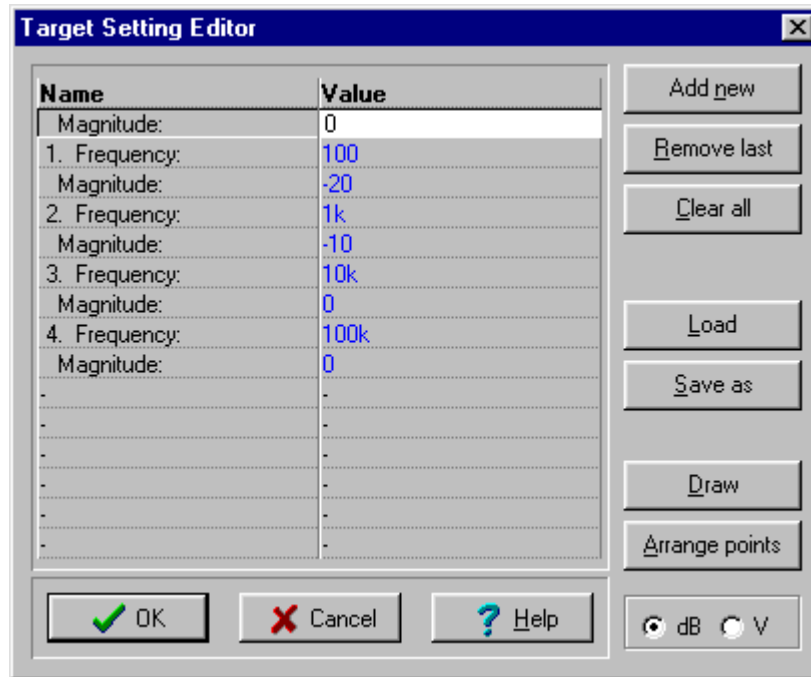

For AC optimization problems, you'll need AC goal functions. With a meter selected, click on the AC Table... or on the AC Goal Functions... button. The AC Table supports a special AC goal function defined by a series of frequency and amplitude values. Using these frequency-amplitude pairs, an AC transfer function can be defined.

## Optimization

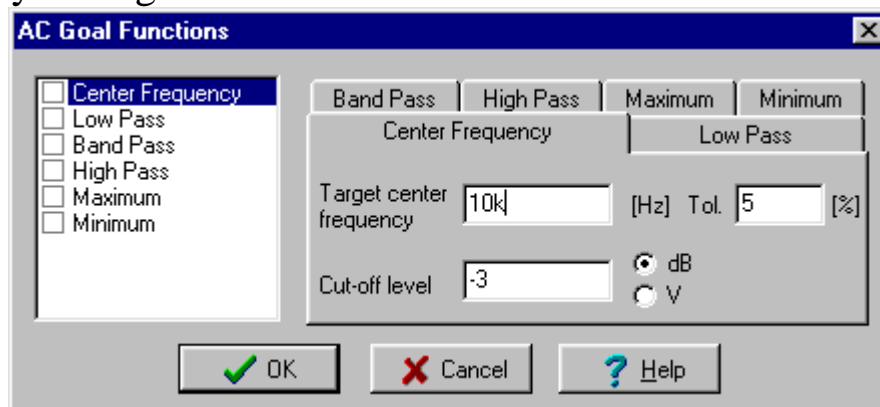

You can access other AC goal functions by pressing the AC Goal Functions... button. Here you'll find Center Frequency, High Pass, Band Pass, and Low Pass target functions, as well as Minimum and Maximum target functions. You can combine these functions, effectively setting more than one criterion.



Now that you have established the target details, you must identify the control object(s) and their parameter(s) to be determined by optimization. To select a component, click on the Analysis.Control Object menu item or on the Select Control Object speed button . A special cursor  will appear in the schematic editor window, waiting for you to identify the component to which the optimized

## Optimization

---

parameter belongs. If you want TINA to optimize using more than one component, repeat the procedure for the other components.

When you point at the component and click, TINA will display all of its associated parameters in a dialog window.

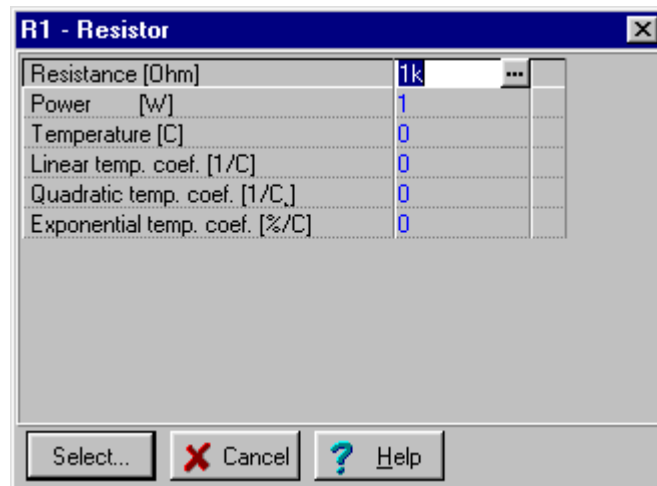

Highlight the parameter to be determined by the optimization process, press the Select button, and enter the Start and End values for the variation of this component's value.

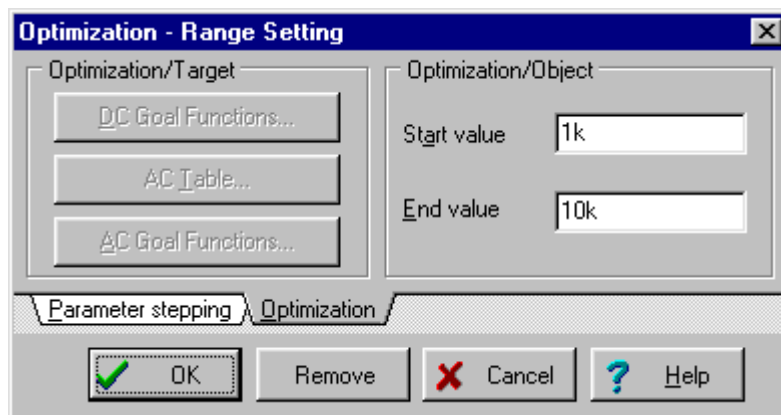

If the desired parameter belongs to a catalog component, or if it is an excitation attribute, you must first select the semiconductor or waveform type so that you can access the appropriate data sheet.

The selected parameter will be varied in the range between the Start and End values while TINA searches for the optimum result at the target. If no optimum is found, then the range will have to be enlarged. If there is more than one optimum case in the range, TINA

will only find one of them. If you suspect that this is the case, try using multiple, narrower ranges, each of which has one or fewer optimums.

You can use the Remove button to deselect a previously assigned control object or optimization target.

Optimization is useful not only in the design of electronic circuits, but in teaching, where you can use it to construct examples and problems. Let us see some examples.

### Two examples

#### Example 1: Differential Amplifier (DC Optimization)

This example illustrates how to use the DC Optimization to set the operating point of a differential amplifier.

1. **Specification:** First load the file named DIFFAMP.TSC from TINA's EXAMPLES/OPTI subdirectory and run Analysis/DC Analysis/Calculate Nodal Voltages to see the original VF1, VF2 collector voltages (3.78V). The goal of the optimization is to change the values of R1A, R1B in order to find those values which meet the specification—2.5V—for both collector voltages.
2. **Set up the optimization:** Before you start the optimization, you have to select those meters which will be monitored during the iteration and which represent the goal of the optimization. In this example, the meters are VF1 and VF2, and the goal establish 2.5V at the collector of the transistors. You also must select those parameters which will be determined by the optimization. In this example, they are the resistances of R1A and R1B.
  - a) **Target:** Use the command Analysis.Optimization Target or the Select Optimization Target speed button  and click on the first voltage pin (VF1). A dialog box appears. When you press the DC Goal Functions... button another dialog appears which allows you to set the goal function for this meter. Select the

Value option and set the value to 2.5. (Note that you mustn't use units here.) Then press OK twice. Repeat this procedure for the other voltage pin, VF2.

- b) **Control object:** Use the command Analysis>Control Object or the Select Control Object speed button  and click on the first control object (R1A). In the property dialog that appears, click on the first line (the resistance parameter). Press the Select button and another dialog appears which allows you to define the Start and End values for the variation of this parameter. Enter 1k and 100k respectively and press OK. Then repeat this procedure for the other resistor, R1B.
3. **Start the optimization:** From the Analysis menu choose Optimization, then DC Optimization... Accept the settings in the dialog that appears and press OK. Now TINA will find new R1A, R1B values to achieve the desired 2.5V collector voltages. After a short iteration the result—the new resistor values—will be shown in a dialog.
4. **Checking the result:** TINA will retain the optimized resistor values. Run Analysis>DC Analysis>Calculate Nodal Voltages to check the new collector voltages with these values. Note that they are now exactly 2.5V as we previously defined in the specification, verifying that the optimization was successful.

### Example 2: Band pass Filter (AC Optimization)

This example illustrates how to use the AC Optimization to obtain a band pass filter which meets transfer function goals.

1. **Specification:** First load the file called BANDPASS.TSC from TINA's EXAMPLES/OPTI subdirectory and run Analysis/AC Analysis/AC Transfer Characteristic... to see the original transfer function. The diagram shows that the maximum of the curve is at about 10kHz, while the peak amplitude of the curve is -10dB. The goal of the optimization is to set the peak amplitude to -7dB and the frequency at which the curve reaches its maximum to 14kHz.
2. **Set up the optimization:** To do an optimization, you have to select those meters which will be monitored during the iteration and which represent the goal of the optimization. In this example, this is the meter "Out." You must also select those parameters which will be varied during the optimization. In this example, these parameters are the resistance of R1 and the capacitance of C1.
  - a) **Target:** Use the command Analysis.Optimization Target or the Select Optimization Target speed button  and click on the voltmeter (Out). A dialog box appears. When you press the AC Goal Functions... button another dialog appears which allows you to set the goal function for this meter. The specification contains two conditions. The first defines the new maximum point of the curve. To set this value, click on the Center Frequency tab, then enter 14k in the Target center frequency edit field. The other condition is the new maximum, -7dB. Select the Maximum tab and enter -7 in the Maximum edit field. The last step is to activate the current goal functions which are the combination of two functions. On the left side of the dialog, select both the Center Frequency and the Maximum function by clicking on the checkbox next to them. Finally press OK twice.

- b) **Control object:** Use the command Analysis>Control Object or the Select Control Object speed button  and click on the first control object (R1). In the resistor property dialog, click on the first line, the resistance parameter. Press the Select button to reach another dialog where you can define the Start and End values for the variation of this parameter. Enter 1k and 10k respectively and press OK. Repeat this procedure for the capacitor (C1), and specify 1n and 10n for the Start and End values respectively.
3. **Start the optimization:** From the Analysis menu, choose Optimization then AC Optimization (Transfer)... Accept the settings in the dialog and press OK. Now TINA will find new R1 and C1 values that will satisfy the specification for the transfer function. After a short iteration the result—the new resistor and capacitor values—will be shown in a dialog box.
4. **Checking the result:** Run Analysis/AC Analysis/AC Transfer Characteristic... to check the new transfer function. The maximum now occurs at 14kHz, with a level at the maximum of -7dB. The optimization was successful



## Design Tool vs. Optimization in TINA

There are cases when writing a design procedure is not obvious or needs iteration or simply we do not have the time to implement it. In this case you may use the Optimization tool in TINA to determine the required parameter numerically in order to meet predefined circuit responses: voltage, current, power, gain, etc.

*Note: Optimization for multiple parameters and target values is available in the Industrial version of TINA only.*

Generally speaking, although optimization is a very powerful tool, it is better to use a design procedure, if available because numerical optimization might need significant calculation time and it does not guaranty physically realistic results. But it is a very good tool to refine the results provided by a design procedure or tune already working circuits.

# Fourier Analysis

## Introduction

In Tina there are many advanced analysis features that provide powerful professional tools to study and evaluate electronic circuits both numerically and graphically. One of them is called spectral or Fourier analysis. In this booklet we will demonstrate Tina's implementation of Fourier analysis which covers two different methods: Fourier series and Fourier spectrum. We will especially emphasize applications that are not described in detail in the manual of Tina. In the following we will shortly summarize the theory behind Fourier analysis, and then present examples on the topic. All the examples are available on floppy disk, as well.

In Tina Fourier analysis must be always performed in conjunction with the transient analysis. This means, that first you always have to carry out a transient analysis on the circuit. When the diagram window appears you have to select the curve you want to process using the cursor and from the *Process* menu choose *Fourier series* or *Fourier spectrum*. In the first part of this booklet we will investigate Fourier series and later on Fourier spectrum.

## Fourier series

One type of spectral analysis is called Fourier or harmonic decomposition. It's based on the theory, that any periodic function can be expressed as the sum, or series of sinusoidal functions. If a periodic function is expressed this way, each component in the series must be periodic over the same interval as the original function. The components are integer multiples or harmonics of the original function's fundamental (base) frequency. This decomposition is described by the following formulas:

$$f(t) = \sum_{k=0}^{\infty} (A_k \cos k\omega t + B_k \sin k\omega t), \text{ or in complex form } f(t) = \sum_{k=-\infty}^{\infty} C_k e^{jk\omega t}, \text{ where}$$

$A_k$ ,  $B_k$ , and  $C_k$  are the Fourier coefficients.

Let us see this decomposition in case of some practical waveforms:

Triangle wave

Square wave

$$f(t) = \frac{8}{\pi^2} \left[ \sin \omega t - \frac{1}{3^2} \sin 3\omega t + \frac{1}{5^2} \sin 5\omega t - \dots \right]$$

$$f(t) = \frac{4}{\pi} \left[ \sin \omega t + \frac{1}{3} \sin 3\omega t + \frac{1}{5} \sin 5\omega t + \dots \right]$$

## Fourier Analysis

Let us demonstrate the above theorem with Tina in case of a square wave of  $f=1\text{kHz}$  frequency and  $1\text{V}$  amplitude up to three sine waves. The easiest way is to put together a simple circuit (fourex1.sch). The circuit consists of three sine wave generators connected in series and the reference square wave generator. The frequencies of the sine wave generators are  $f_1=1\text{kHz}$ ,  $f_2=3f_1=3\text{kHz}$  and  $f_3=5f_1=5\text{kHz}$ , however the amplitudes are  $A_1 = \frac{4}{\pi} = 1.2732$ ,  $A_2 = \frac{1}{3}A_1 = 0.4244$  and  $A_3 = \frac{1}{5}A_1 = 0.2546$  according to the above formula.

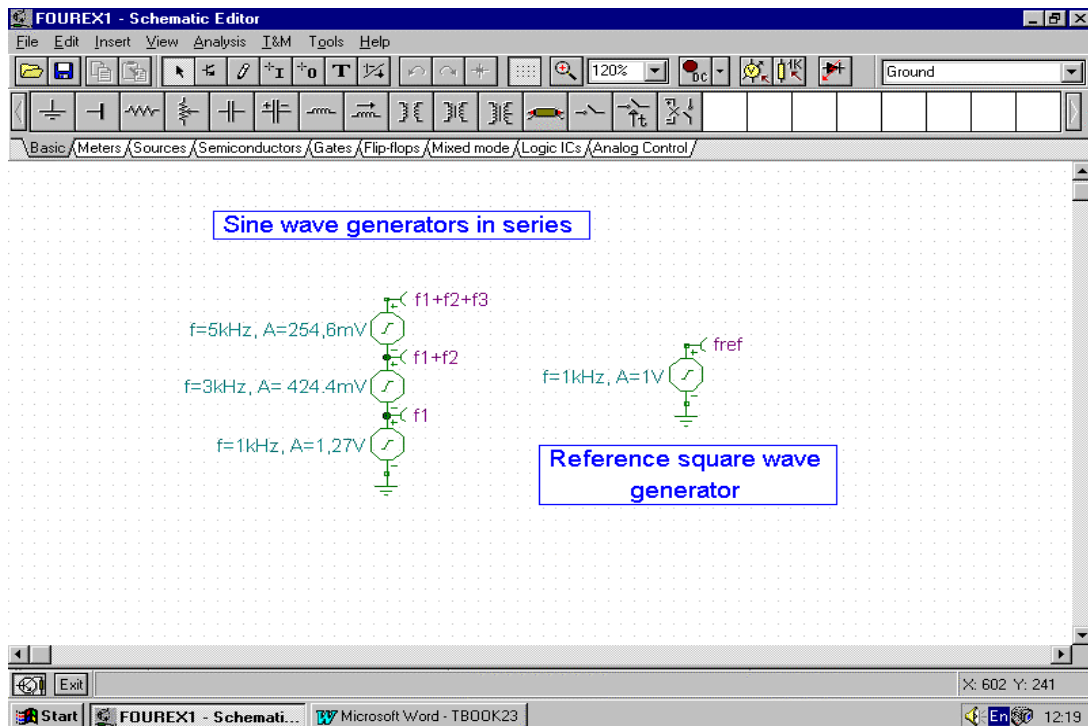



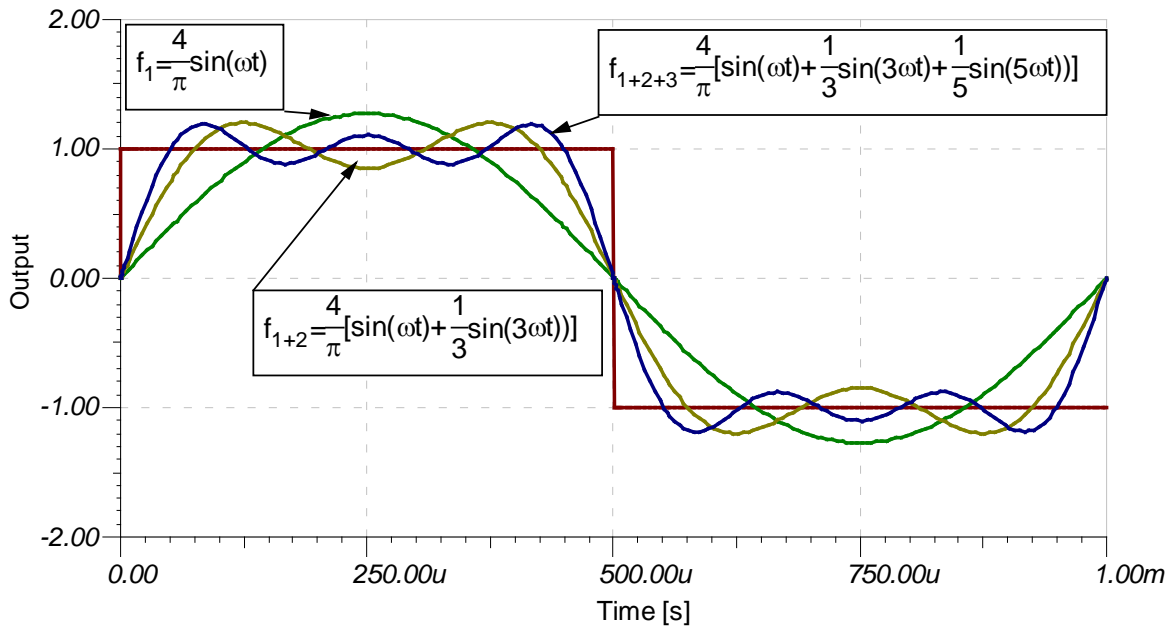

The result of the transient analysis can be seen on the following figure.

## Fourier Analysis

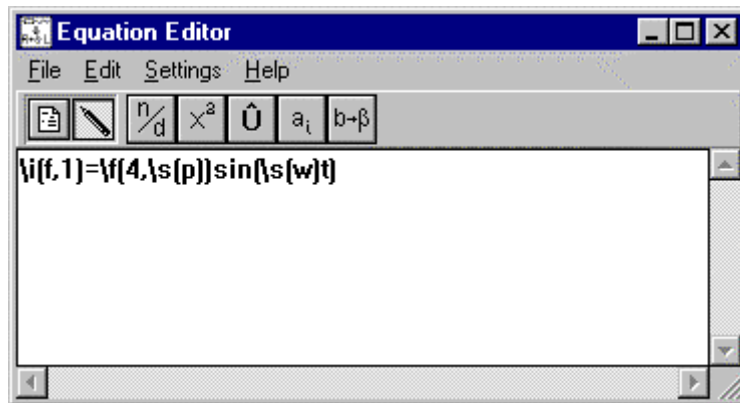

Note that the above figure was entirely made by Tina using its Equation Editor in the Diagram Window. For example the  $f_1 = \frac{4}{\pi} \sin(\omega t)$  is described in the following way in the Equation Editor's text mode:  $\backslash i(f,1)=\backslash f(4,\backslash s(p))\sin(\backslash s(w)t)$  as it can be seen on the next figure.



If you press the View button  you can preview the formula in the Equation Editor. Press the Edit button  to return into the text mode if you want to make further changes. Finally press the Copy button  to place the formula in the Diagram Window.

## Fourier Analysis

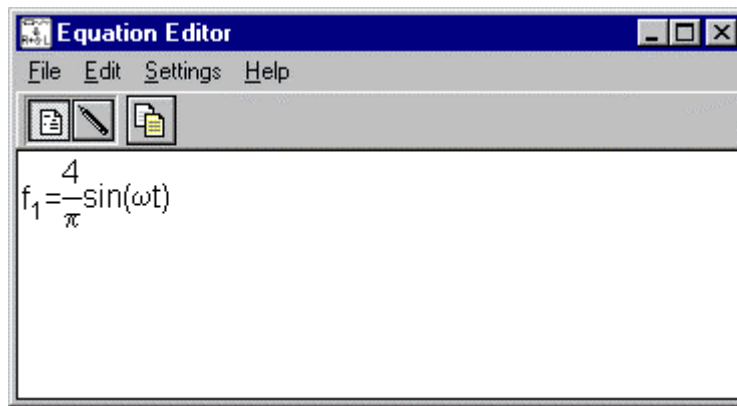

Obviously if you connected more than 3 generators in series, you would have achieved a better match. There is an easy way to demonstrate this statement. Using Tina's Interpreter you can easily write a function that calculates the sum of any number of sine waves (fourex1.ipr).

```
Function Square(t, n);
{Sum of n sine waves, n: number of sine waves, t: time}
Begin
  f := 1k;
  w := 2 * pi * f;
  x := 0;
  For i := 0 To n - 1 Do
    x := x + 1 / (2 * i + 1) * sin((2 * i + 1) * w * t);
  Square := 4 / pi * x;
End;

{Sum of 20 sine waves}
Draw(Square(Time, 20), Square);
```

To run the above example invoke the Interpreter from the Tools menu, type in the above text or read in fourex1.ipr by selecting the Open command from the File menu. If you press the Run  button after a short calculation the following function appears:

## Fourier Analysis

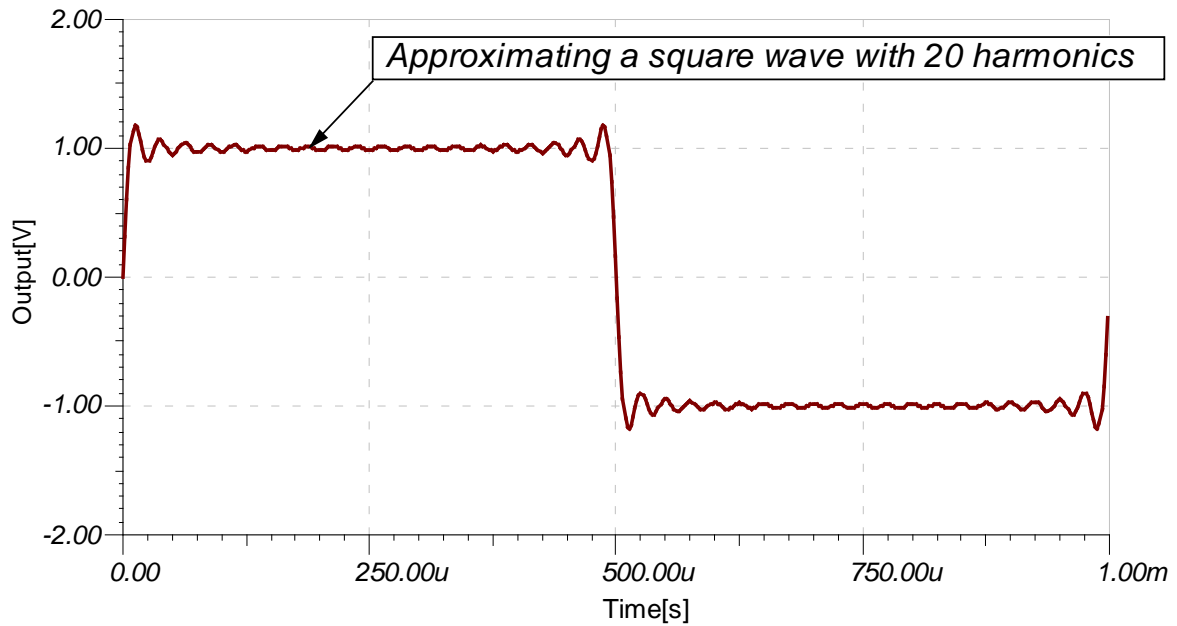

The more sine waves you would sum up the better match you would get. Note however the small peaks at the edges of the square wave. This is called Gibbs phenomenon. According to the mathematical theory the Fourier series can not approximate properly non-continuous functions in the point of discontinuity. In case of a square wave there will always be 18% overrun at the edges at any number of approximating sine waves. Let us demonstrate this with 100 harmonics; simple change 20 to 100 in the Draw command of the above example (fourex1.ipr)

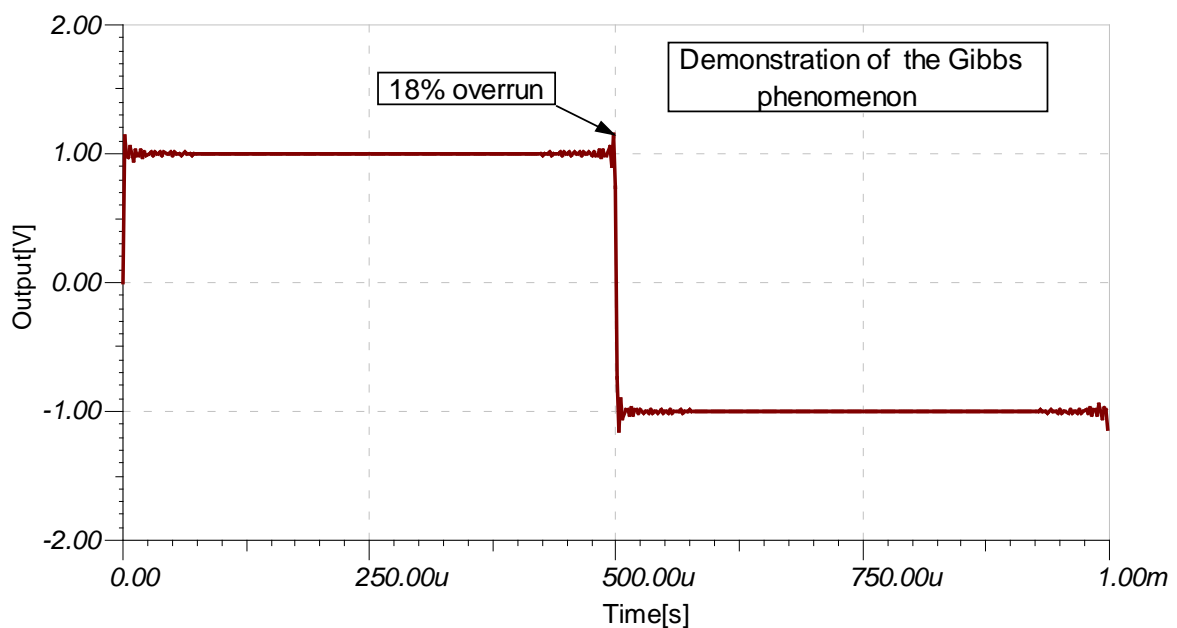

## Fourier Analysis

However there are methods which improve the convergence of the Fourier series near the discontinuity. The essence of these techniques is to modify the Fourier coefficients by multiplying each coefficient by a weight factor. This method is also called window function technique. Two Hungarian mathematicians - Fejér, and Lánčzos - invented such window functions that are commonly used in practice. In practice however there are no discontinuous waveforms though to the rise/fall time could be very short in comparison to the period time. This means, that the Fourier series will always converge. Let us demonstrate this with the approximation of the triangular waveform with just 3 harmonics using the above circuit. Change the amplitude of the sinusoidal generators to  $A_1 = \frac{8}{\pi^2} = 0.8106$ ,  $A_2 = -\frac{1}{3^2}A_1 = 0.0901$  and  $A_3 = \frac{1}{5^2}A_1 = 0.0324$ . Change the waveform of the reference generator to triangle wave (fourex12.sch).

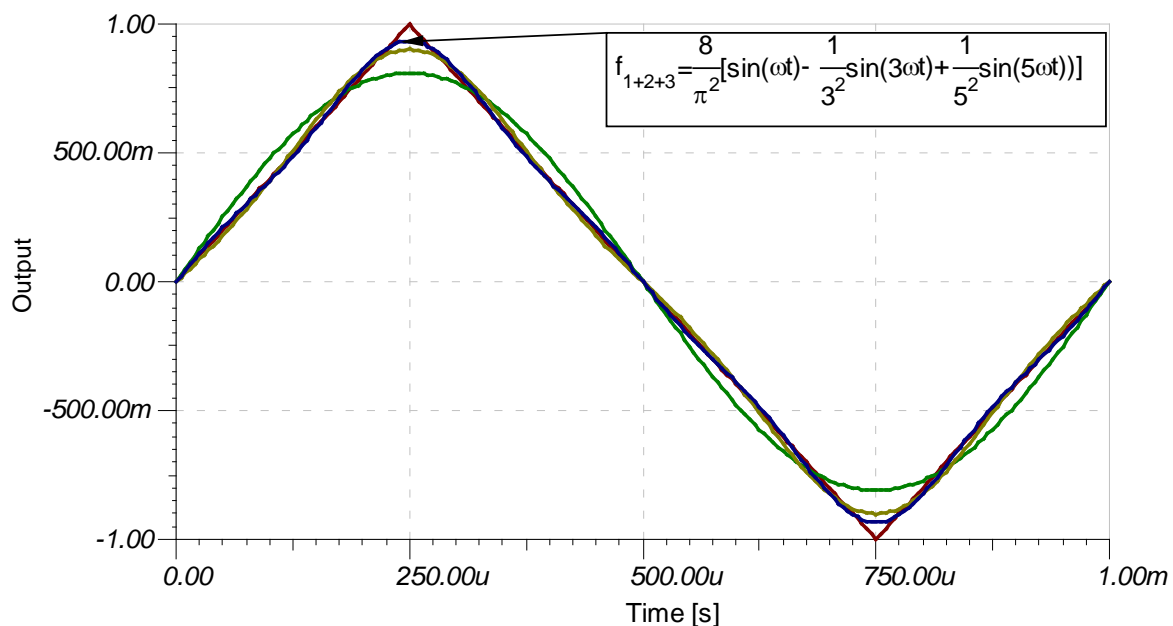

In practice of course you use the Fourier series option of TINA in opposite direction. You have a periodic function and you want to know the Fourier components. To get them in Tina first you have to run a transient analysis and then in the appearing Diagram window select a curve. Then in the diagram window you have to select Fourier series from the Process menu. After selecting this menu item Tina performs a harmonic decomposition, calculating the Fourier



coefficients for the sinusoidal components of any voltage or current. After you select Fourier series a dialog box appears, where you have to set the sampling start time, the base frequency, the number of samples, the number of harmonics, and the format.

*Example:* Let us determine the Fourier decomposition of the previous square wave ( $f=1\text{kHz}$ ,  $A=1\text{V}$ ). We will compare the theoretical decomposition with the result calculated by TINA.

The Fourier series of a square wave function is

$$f(t) = \frac{4}{\pi} \left[ \sin \omega t + \frac{1}{3} \sin 3\omega t + \frac{1}{5} \sin 5\omega t + \dots \right].$$

Because square wave function is an odd function  $/f(-x) = -f(x)/$ , all the coefficients  $A_k = 0$ , and  $A_0 = 0$ , too. Comparing the above function with the definition of the Fourier series it's quite clear that:  $B_1 = \frac{4}{\pi} = 1.27$ ,  $B_2 = 0$ ,  $B_3 = \frac{1}{3}B_1 = 0.42441$ ,  $B_4 = 0$ ,  $B_5 = \frac{1}{5}B_1 = 0.25464$ . In Tina we get approximately the same result. However due to numerical inaccuracy we don't get exactly 0 for the theoretically 0 coefficients. If you examine these values more carefully you'll see, that they are not significant because they are  $10^{-6} - 10^{-9}$  times less than the fundamental value.

Load this example (fourex2.sch). Run transient analysis then select the appearing square wave and choose Fourier series from the *Process* menu. In the dialog box change the default format from complex representation  $/ C * \exp(k\omega t + \phi) /$  to real representation  $/ A * \cos(k\omega t) + B * \sin(k\omega t) /$ .

## Fourier Analysis

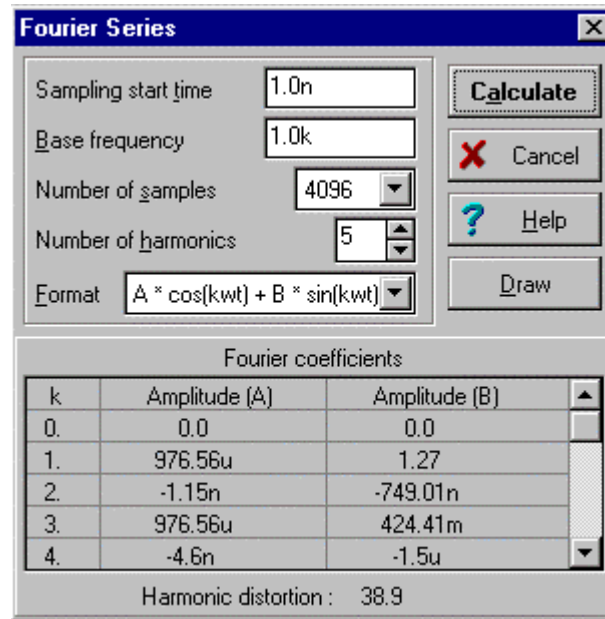

If you have set all the parameters, press *Calculate*. At the bottom of the dialog box the Fourier coefficients appear. Tina allows you to use these values in other programs. Every time you press *Calculate* the coefficients are placed not only at the bottom of the dialog box but on the clipboard, as well. You can import this table of Fourier components in other programs, for example Word or Excel to process.

Harmonics	Amplitude (A)	Amplitude (B)
0.	0	0
1.	976.56u	1.27
2.	-1.15n	-749.01n
3.	976.56u	424.41m
4.	-4.6n	-1.5u
5.	976.56u	254.64m

It's also possible to evaluate the above result graphically. You only need to press *Draw*, then Tina generates you a diagram with the Fourier coefficients.

## Fourier Analysis

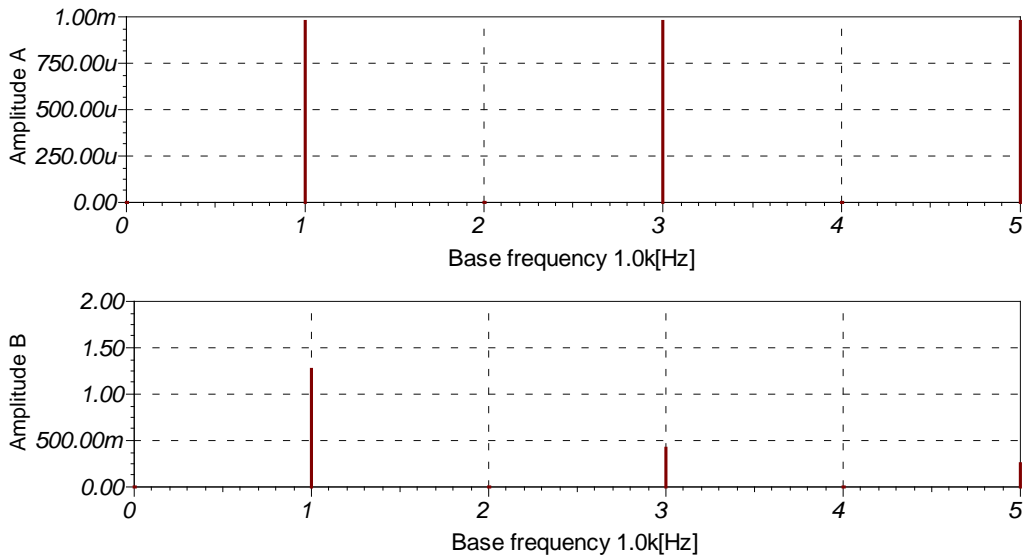

You can also get complex Fourier components with Tina. To do this select the complex representation in the Fourier series dialog box and press *Calculate* again. On the following three figures you'll see the harmonic decomposition of the same sine wave ( $f=1\text{kHz}$ ,  $A=1\text{V}$ ) but this time using the complex representation. On the first figure the dialog box can be seen, on the next the Fourier coefficients as they are placed on the clipboard, and on the last the graphical representation of the result.

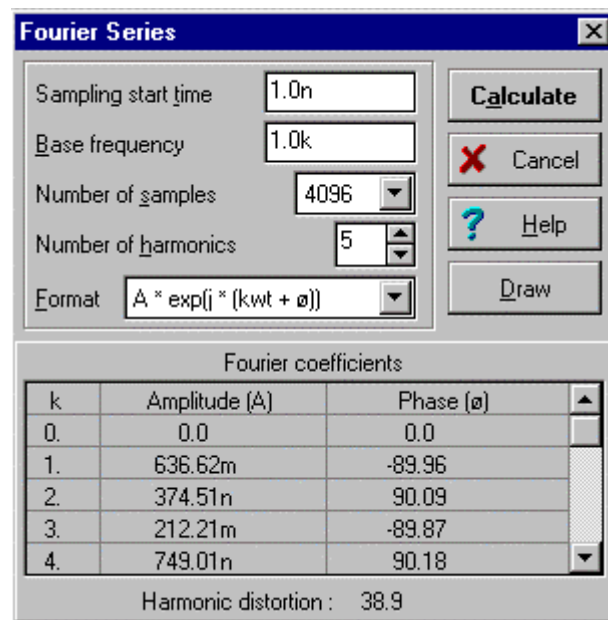

## Fourier Analysis

Harmonics	Amplitude (A)	Phase ( $\phi$ )
<b>0.</b>	0	0
<b>1.</b>	636.62m	-89.96
<b>2.</b>	374.51n	90.09
<b>3.</b>	212.21m	-89.87
<b>4.</b>	749.01n	90.18
<b>5.</b>	127.32m	-89.78

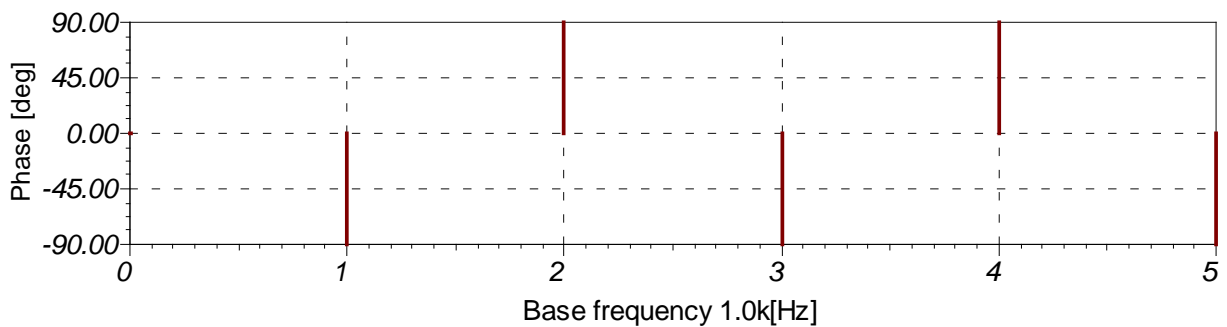
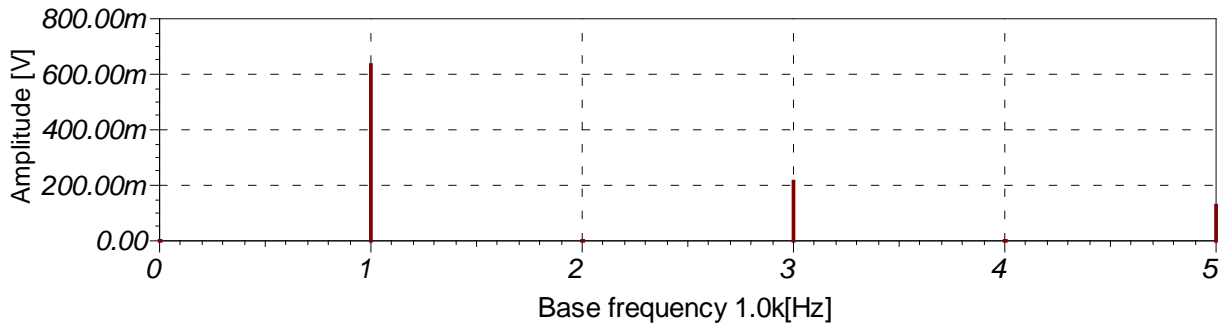

To compare this result with the previous one we have to perform a simple mathematical transformation. Using the Euler-formula:

$$\frac{A_k + jB_k}{2} = C_{-k}, \text{ and } \frac{A_k - jB_k}{2} = C_k \text{ or vice versa } C_k + C_{-k} = A_k, \text{ or } C_{-k} - C_k = B_k.$$

From this we get, that  $C_1 = \frac{A_1}{2} = 0.63662$ ,  $C_2 = 0$ ,  $C_3 = \frac{A_3}{2} = 0.21221$ ,  $C_4 = 0$ ,

$C_5 = \frac{A_5}{2} = 0.12732$ . Again it is important to mention, that due to numerical

inaccuracy we don't get exactly 0 for the theoretically 0 coefficients. It's especially true in case of the phase values. As harmonic magnitudes become small it becomes difficult to determine phase. Again, this is a numerical problem only.

### Fourier spectrum

Tina provides another type of spectral analysis called Fourier transform. Fourier transform can also be thought of as an extension of the Fourier series. This means the Fourier transform converts a function of time to a function of frequency, and vice versa. The physical interpretation of Fourier transform is the conversion of a time-domain signal to the AC steady-state frequency spectrum.

$$F(j\omega) \equiv \mathcal{F} f(t) = \int_{-\infty}^{\infty} f(t)e^{-j\omega t} dt$$

However the inverse Fourier transform converts the AC steady-state signal into the time-domain.

$$f(t) \equiv \mathcal{F}^{-1} F(j\omega) = \frac{1}{2\pi} \int_{-\infty}^{\infty} F(j\omega)e^{j\omega t} d\omega$$

The Fourier transform in Tina is a discrete Fourier transform (DFT), where the Fourier integral has been replaced by a nearly equivalent summation formula applied to evenly spaced samples of the signal. To speed up the process the transform is accomplished by a special technique, called fast Fourier transform (FFT). The FFT gets its data from a set of samples with the appropriate number of data points.

Sometimes it's useful to define the real spectrums (amplitude-densities):

$$F(j\omega) = \frac{A(\omega) - jB(\omega)}{2}, \text{ where}$$

$$A(\omega) = 2\text{Re} F(j\omega) \text{ and } B(\omega) = -2\text{Im} F(j\omega)$$

Note, that Tina calculates  $F(j\omega)$  and displays in the  $0 < \omega < \infty$  region only. For the  $-\infty < \omega < 0$  region applies  $F(j\omega) = F(j\omega)^*$ , therefor the amplitude is the same and the phase has opposite sign.

$A(\omega)$ ,  $B(\omega)$  can also be calculated directly from the time function.

$$A(\omega) = 2 \int_{-\infty}^{\infty} f(t) \cos \omega t dt \text{ and } B(\omega) = 2 \int_{-\infty}^{\infty} f(t) \sin \omega t dt$$

$A(\omega) = A(-\omega)$ ,  $B(-\omega) = -B(\omega)$  thus  $A(\omega)$  is an even,  $B(\omega)$  is an odd function.

## Fourier Analysis

*Example:* Let's determine the complex spectrum of a pulse (amplitude 1, width  $T=1n$ ; fourex3.sch) and compare it with the theoretical result. First carry out a transient analysis then select the pulse wave and choose Fourier spectrum from the *Process* menu.

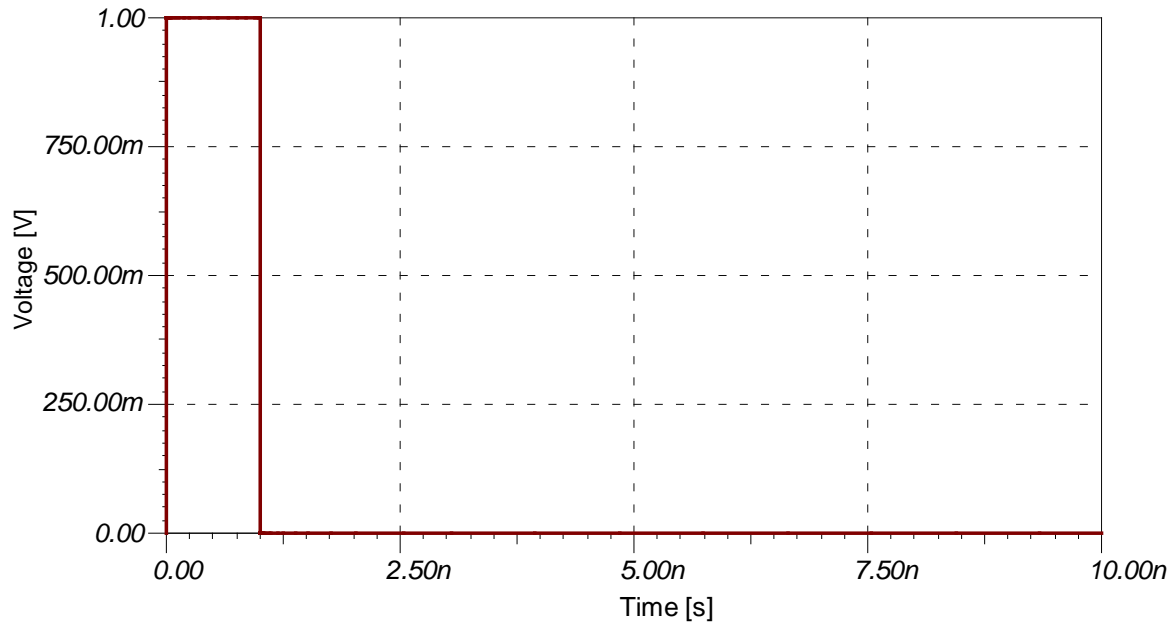

After you select Fourier spectrum a dialog box appears, where you have to set the sampling start and end time, the minimum and maximum frequency and the number of samples. You can also choose the diagrams you want to display.

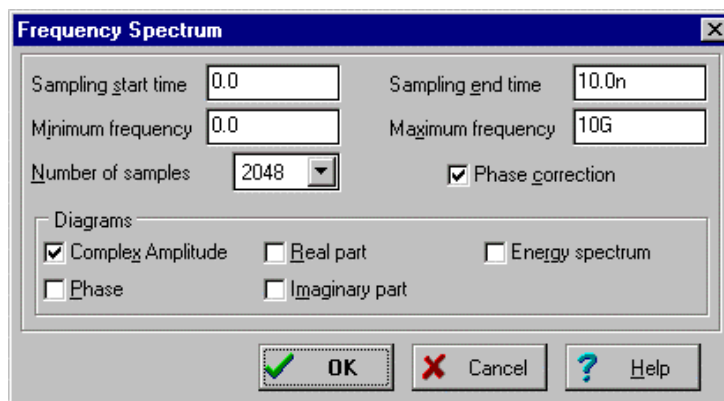

If you press OK Tina performs discrete Fourier transform. The complex amplitude spectrum can be seen on the following figure:

## Fourier Analysis

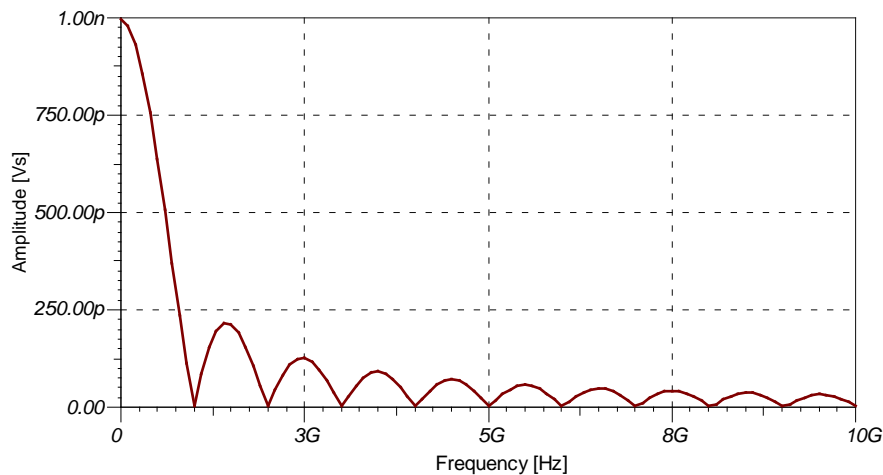

This function is described by the well-known formula:

$$F(j\omega) = \int_0^T 1 * e^{-j\omega t} dt = \frac{1 - e^{-j\omega T}}{j\omega} = e^{-j\omega T/2} \frac{e^{j\omega T/2} - e^{-j\omega T/2}}{j\omega} = \frac{2}{\omega} \sin \frac{\omega T}{2} e^{-j\omega T/2}, \quad \text{therefore}$$

the amplitude spectrum is:  $|F(j\omega)| = \frac{2}{\omega} \left| \sin \frac{\omega T}{2} \right|, 0 < \omega < \infty$

To check our previous result now we will recalculate the amplitude spectrum using the above formula in Tina's Interpreter (fourex2.ipr). The following function calculates the amplitude spectrum.

```
Function PulseAmplSpe(f);  
Begin  
  w := 2 * pi * f;  
  T := 1n;  
  PulseAmplSpe := 2 / w * Abs(Sin(w * T / 2));  
End;  
  
Draw(PulseAmplSpe(Frequency), AmplSpe);
```

To try out the above example invoke the Interpreter from the Tools menu, type in the above text or read in fourex2.ipr by selecting the Open command from the File menu. If you press the Run  button after a short time the following function appears:

## Fourier Analysis

---

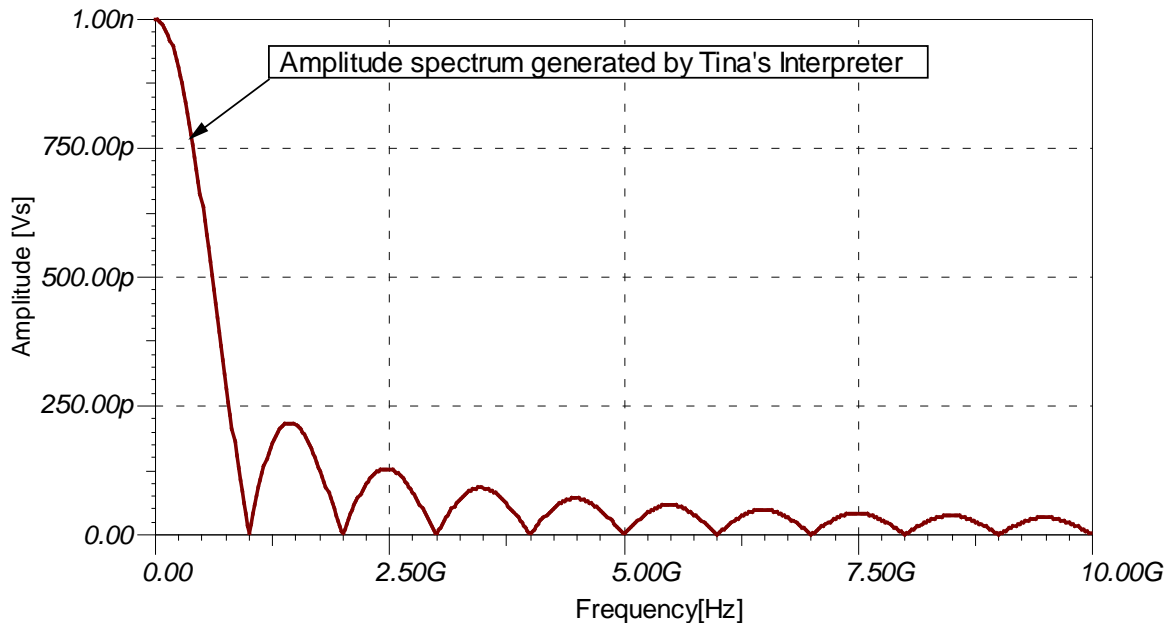

You can easily check, that the above spectrum provided by the closed formula and the spectrum provided by Tina's Fourier Spectrum command are exactly the same. It's rather easy to compare these curves using the clipboard. First select the curve which was generated by the Interpreter, then copy this curve onto the clipboard then in the diagram window go back to the previous page and paste the curve back. The curves will be identical, so we do not show here both.

*Example:* Transform of a sine wave (fourex4.sch)

The Fourier transform of a sine wave results in a Dirac-delta function, that is an infinitely high spike of zero width at the frequency of a sine wave. We can not reproduce that with DFT. We can actually examine sine waves of finite length. The longer the sine wave is, the taller and narrower the spectrum becomes.

Let us first examine a 3ms long sine wave with 1kHz frequency.



## Fourier Analysis

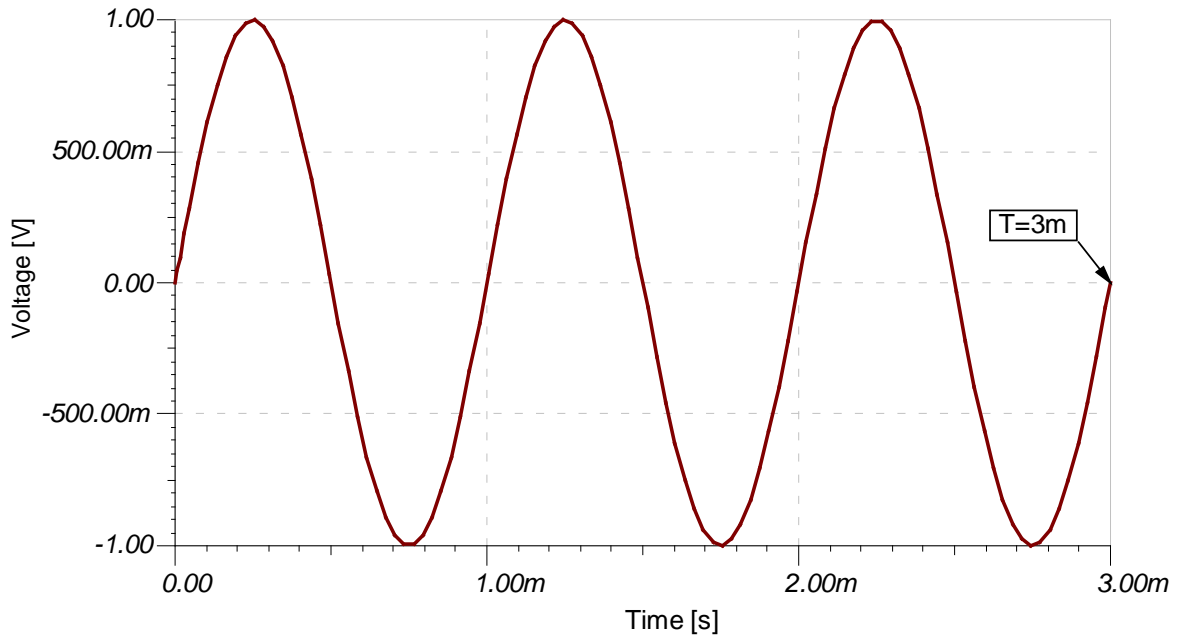

If you run Fourier spectrum on this curve you will get the following result.

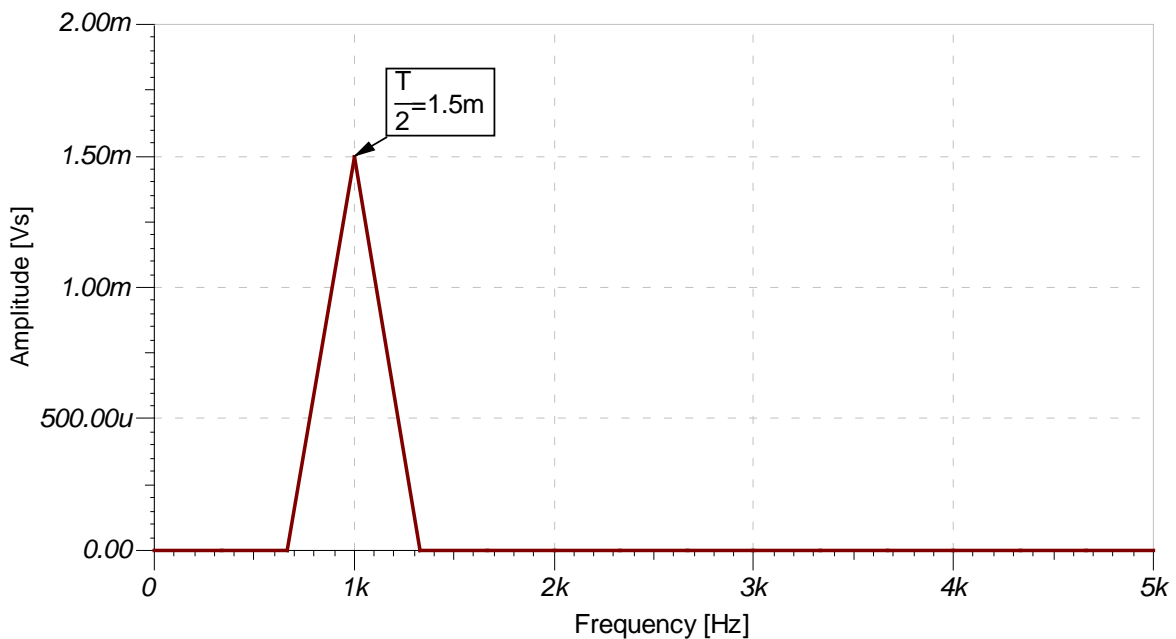

Although the peak value of this spectrum is correct the shape of the spectrum is quite rough. To get a better spectrum change the simulation time to 21ms and carry out the analysis again. At FFT the frequency resolution is inversely proportional to the duration of the signal.

## Fourier Analysis

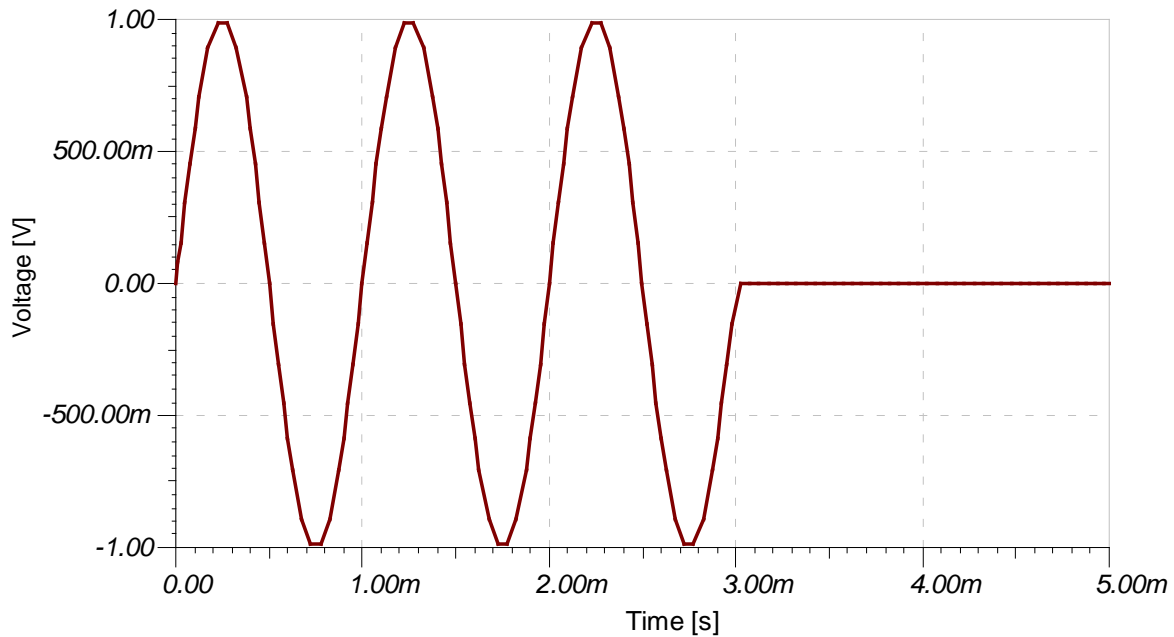

Note that the actual simulation time in this example was 21ms to get a better spectrum. (Not shown on the figure.)

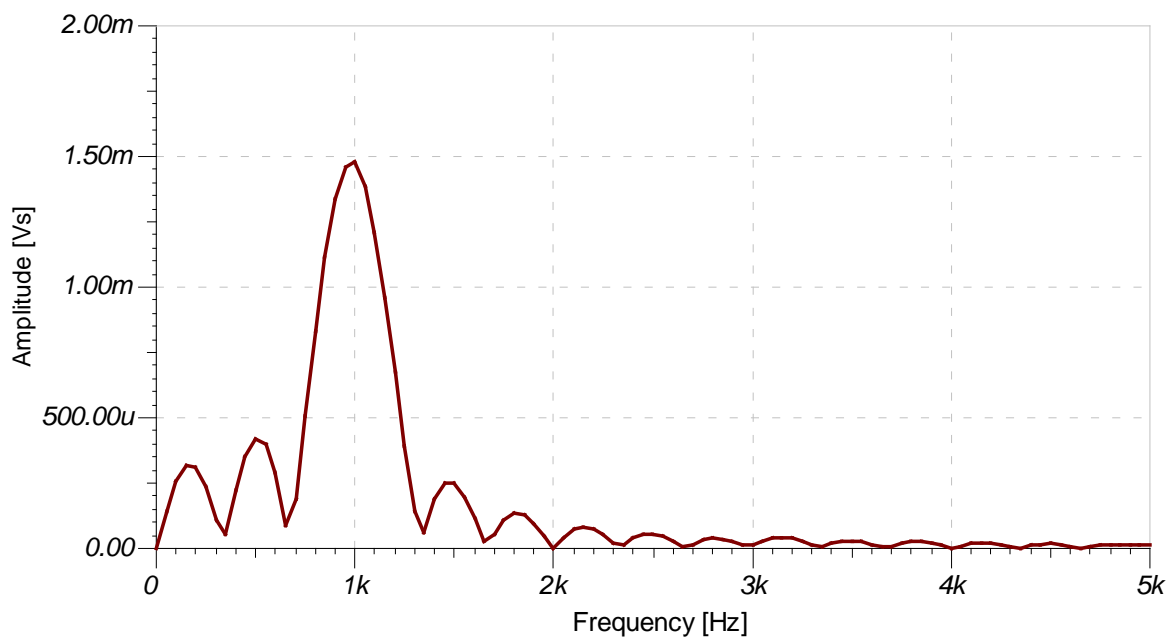

Let us check this result using the theory of Fourier transform:

$$F\{d(t) \sin \omega_0 t\}, \text{ where } d(t) = \varepsilon(t) - \varepsilon(t-T) = \begin{cases} 0, & \text{if } t < 0 \text{ or } t > T \\ 1, & \text{if } 0 \leq t \leq T \end{cases}$$

## Fourier Analysis

---

$$F(j\omega) = \int_{-\infty}^{\infty} d_T(t) \sin \omega_0 t e^{-j\omega t} dt = \int_{-\infty}^{\infty} d_T(t) \frac{e^{j\omega_0 t} - e^{-j\omega_0 t}}{2j} e^{-j\omega t} dt = \frac{1}{2j} \left\{ \int_0^T e^{-j(\omega - \omega_0)t} dt - \int_0^T e^{-j(\omega + \omega_0)t} dt \right\} =$$
$$e^{-j(\omega - \omega_0)\frac{T}{2}} \frac{\sin(\omega - \omega_0)\frac{T}{2}}{j(\omega - \omega_0)} - e^{-j(\omega + \omega_0)\frac{T}{2}} \frac{\sin(\omega + \omega_0)\frac{T}{2}}{j(\omega + \omega_0)}$$

Note, that the main amplitude of the spectrum at  $\omega = \omega_0$  and at  $\omega = -\omega_0$  is  $T/2$ . Let us draw this function with Tina's Interpreter (fourex3.ipr). In this example we will use a simplified expression, because this part is significant only regarding the amplitude of the spectrum. The following simplified function calculates the amplitude spectrum.

```
Function SinusAmplSpe(f);
Begin
  w := 2 * pi * f;
  w0 := 2 * pi * 1k;
  T := 3m;
  SinusAmplSpe := Abs(Sin((w - w0) * T / 2) / (w - w0) -
    Sin((w + w0) * T / 2) / (w + w0));
End;

Draw(SinusAmplSpe(Frequency), AmplSpe)
```

To try out the above example invoke the Interpreter from the Tools menu, type in the above text or read in fourex3.ipr by selecting the Open command from the File menu. If you press the Run  button after a short time the following function appears:

## Fourier Analysis

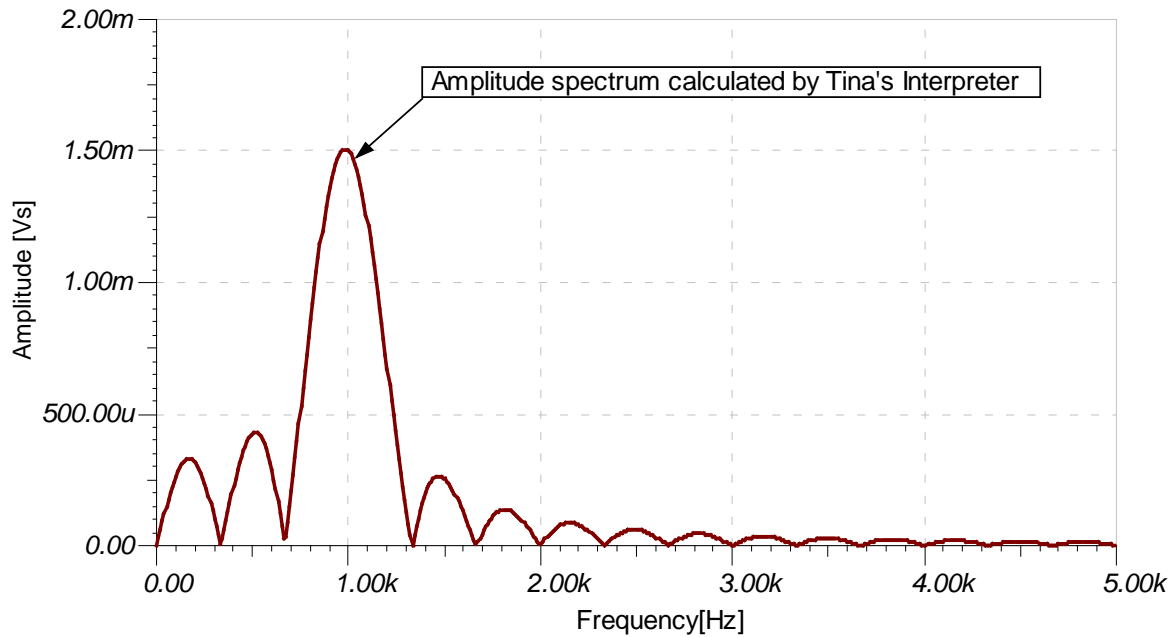

You can easily check, that the above spectrum provided by the closed formula and the spectrum provided by Tina's Fourier Spectrum command are exactly the same. It's rather easy to compare these curves using the clipboard. First select the curve which was generated by the Interpreter, then copy this curve onto the clipboard then in the diagram window go back to the previous page and paste the curve back. The curves will be identical, so we do not show here both.

*Example:* Amplitude modulation (am.sch).

Let us see the spectrum derived by amplitude modulation. In our example the amplitude modulated signal is described by the following formula:  $\sin(\omega_0 t) * (1 + m \cos(\omega_m t))$ , where  $\omega_0 = 1\text{MHz}$ ,  $\omega_m = 100\text{kHz}$ ,  $m=0.5$ .

## Fourier Analysis

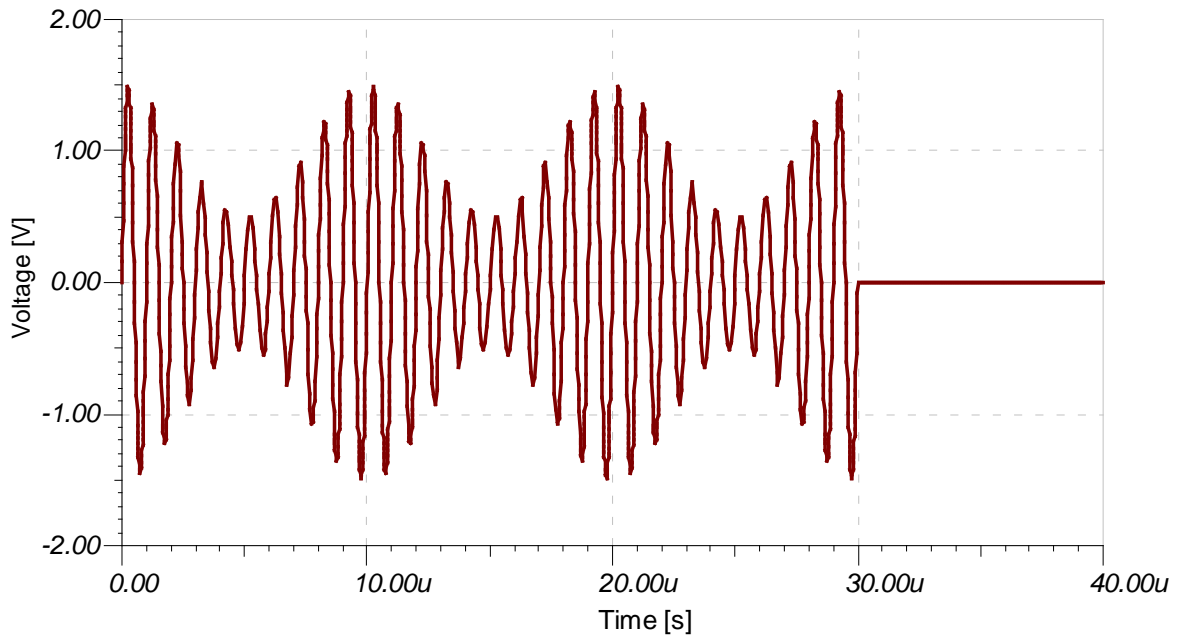

Let's calculate the Fourier spectrum of the modulated waveform:

$$\sin(\omega_0 t) * (1 + m \cos(\omega_m t)) = \sin \omega_0 t + \frac{m}{2} \sin(\omega_0 + \omega_m)t + \frac{m}{2} \sin(\omega_0 - \omega_m)t . \text{ In our case:}$$

$\sin(1e6t) * (1 + 0.5 \cos(1e5t)) = \sin 1e6t + 0.25 \sin(1.1e6)t + 0.25 \sin(0.9e6)t .$  From this formula it's clear, that the spectrum of the modulated waveform is the sum of the spectrum of three sinusoidal signals. First check our result using Fourier series. Select Fourier Series from the Process menu and set the Format field to  $A \cos(k\omega t) + B \sin(k\omega t)$  . Then press Calculate.

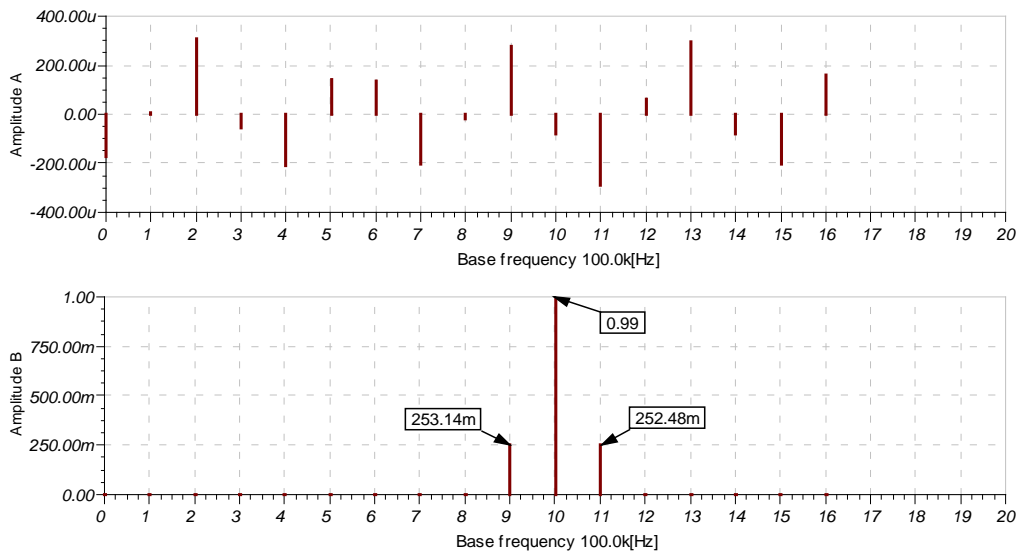

The cosinusoidal coefficients (A) are practically zero and for the sinusoidal coefficients (B) we get the theoretical result.

## Fourier Analysis

---

On the next figure the Fourier spectrum of the same signal can be seen.

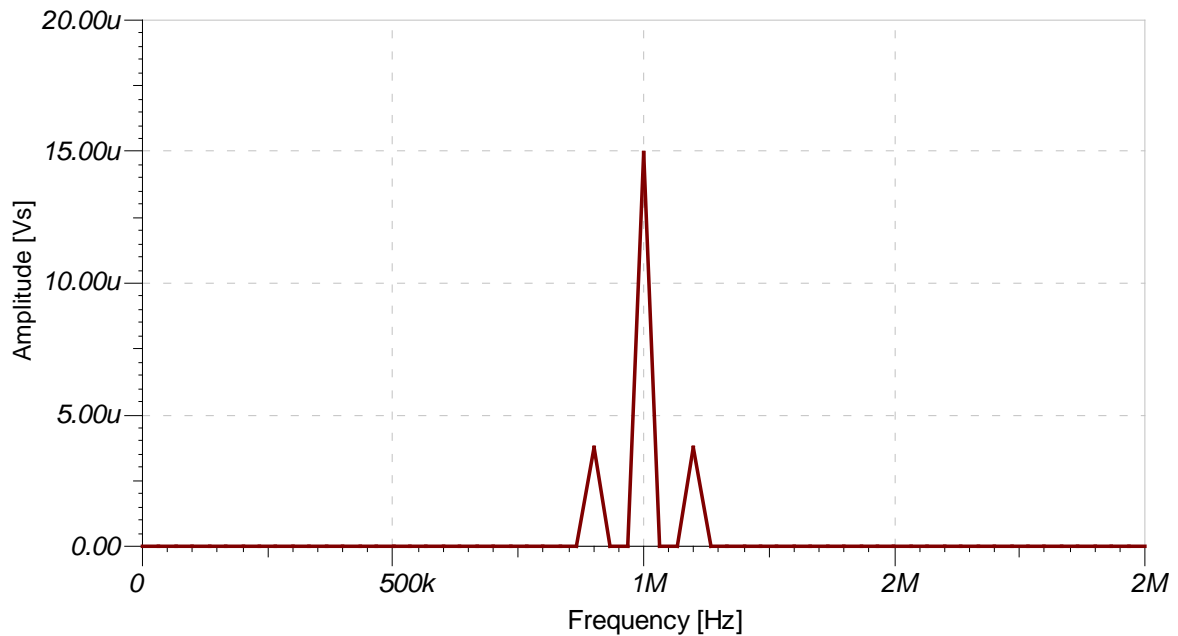

You can see, that the amplitude of the smaller spikes is the quarter of the amplitude of the peak at the base frequency, which is  $15\mu = T/2$ , where  $T=30\mu$  is the length of the modulated wave.

And finally on the last figure you can see the spectrum in case of 210us simulation time.

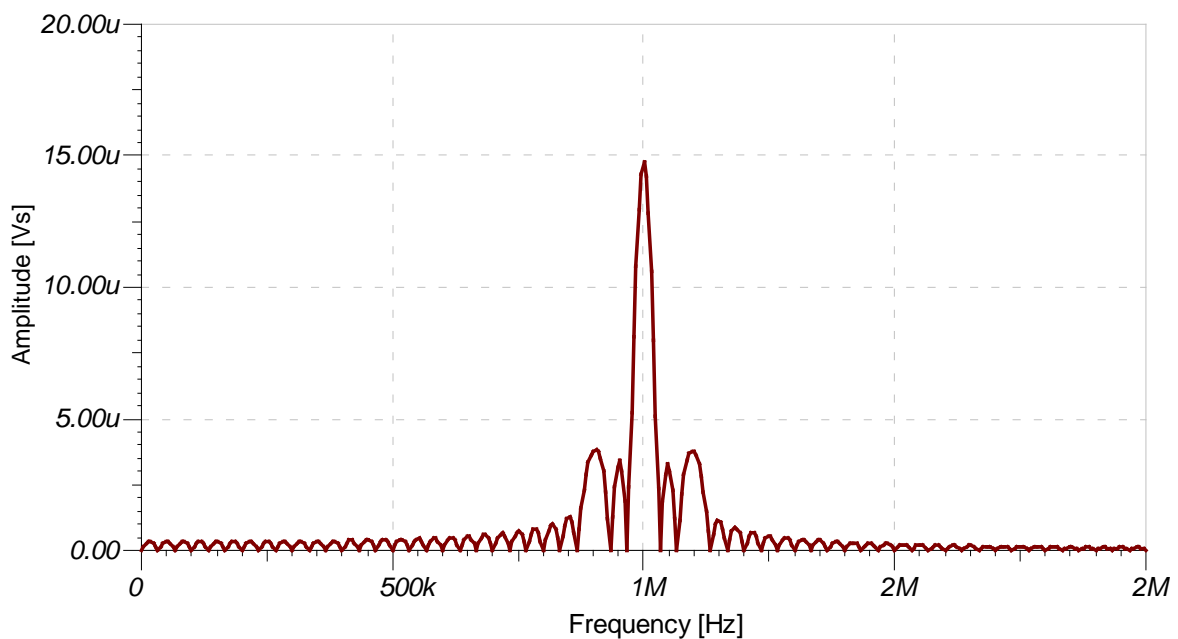

## Fourier Analysis

The Fourier spectrum and the Fourier series dialog box can also be obtained directly from the Analysis>Fourier Analysis menu. This way you do not need to calculate the transient function manually—TINA will automatically do it before generating the Fourier series or spectrum.

### Harmonic distortion

In Tina you can also calculate the harmonic distortion.

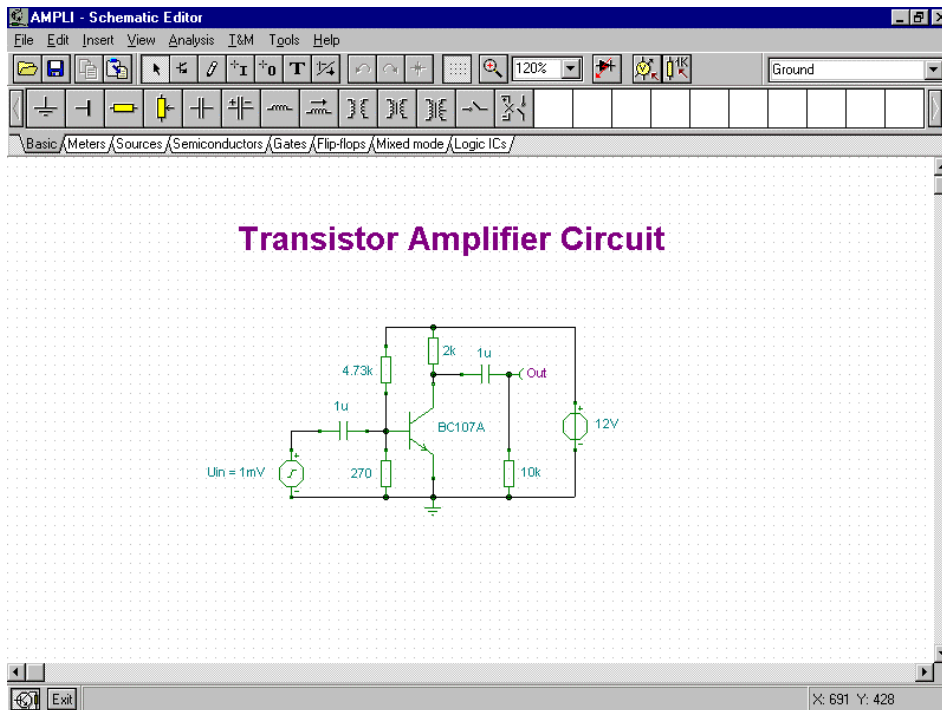

To illustrate this, run the transient analysis with the above circuit (ampli.sch) then the following figure appears:

## Fourier Analysis

---

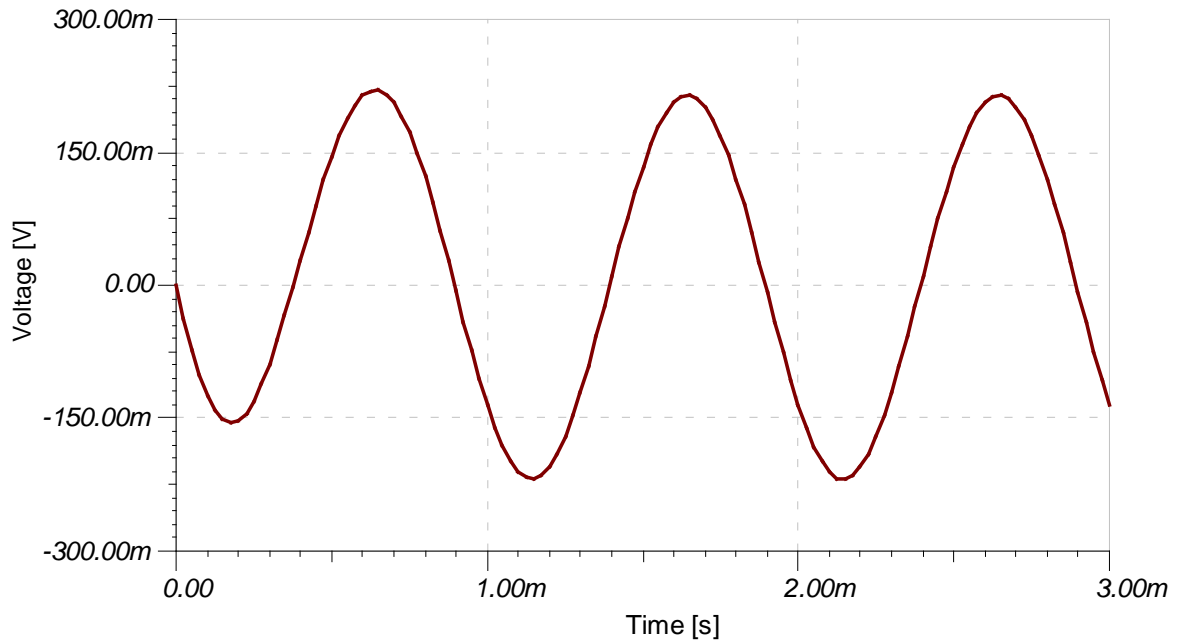

Select the output curve then press the right button of the mouse and select Fourier Series from the popup menu: the dialog box of the Fourier series will appear. Set **Sampling start time** to 1ms and the **Number of samples** to 4096. Note that for best accuracy, it is very important to set the starting time for the Fourier Series analysis to after the initial transient has died away. Now press **Calculate**. Tina calculates you the Fourier coefficients and the harmonic distortion, which is defined to be the ratio of the root-mean-square (RMS) sum of the magnitude of the harmonics to the magnitude of the fundamental, or as a percentage:  $\%THD = 100 * \sqrt{\frac{V_2^2 + V_3^2 + \dots + V_n^2}{V_1^2}}$ , called percent total harmonic distortion (%THD).



# Fourier Analysis

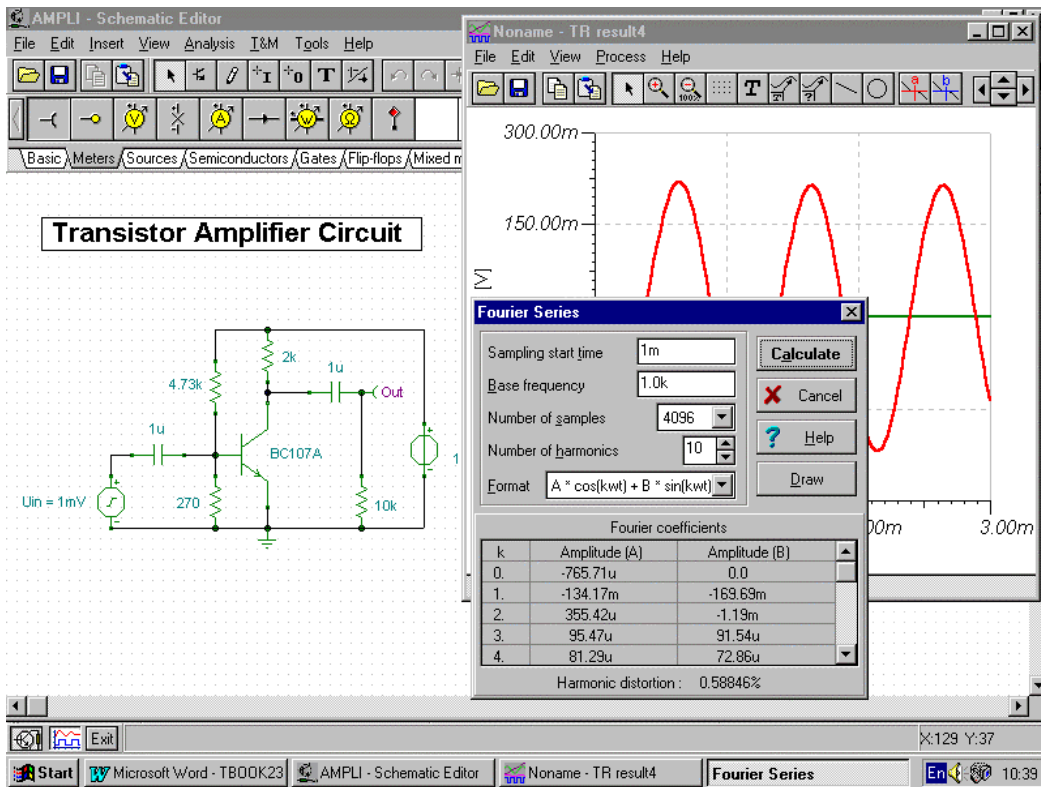

## Using IBIS Models in TINA

**IBIS (Input/Output Buffer Information Specification)** is a method to provide modeling information about the input/output buffers of integrated circuits. The good thing about IBIS models is that they are often available even for devices where complete device models are not available from manufacturers for any reason (e.g., complexity, proprietary information protection, etc.). One of *the most popular uses of IBIS models is Signal Integrity Analysis*, including impedance matching and more. TINA currently supports the most widely used IBIS 4.2 version.

In TINA, you can convert IBIS models to TINA Spice macros and then use them in any circuits in TINA. You can also complete simplified digital device models—e.g., MCUs with IBIS models—to better describe their analog behavior.

In the following, we will show the use of IBIS models through an example of fixing signal integrity between a Texas Instrument TMS320C6748DSP and an ADS1259 delta-sigma ADC.

Select *File/Import/IBIS File (\*.ibs)*, select *c6748zce.ibs* from *<TINA directory>\Examples\IBIS*. The following dialog will be displayed. In this dialog, you can select the model to import.

## Using IBIS Models in TINA

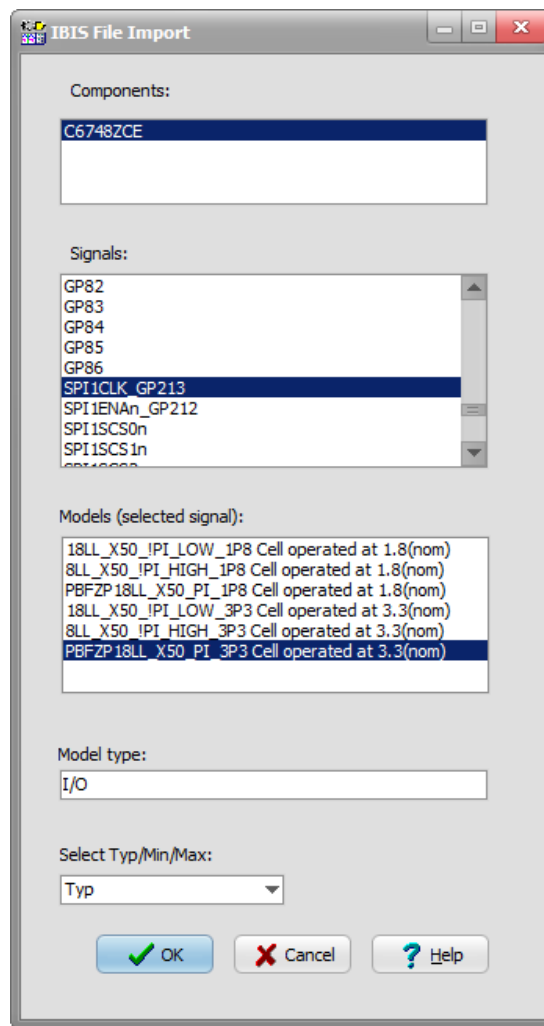

Now select *SPI1CLK\_GP213* signal, *PBFZP18LL\_X50\_PI\_3P3* model (cell operated at 3.3V without pullup or pulldown), and *Typ* value set. Press OK. The IBIS model is automatically converted to a Spice macro.

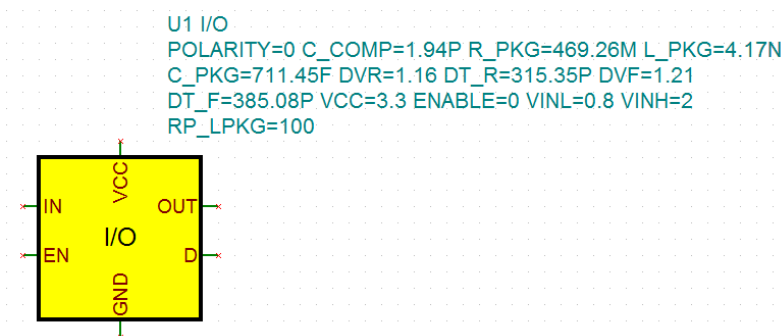

## Using IBIS Models in TINA

SPI1CLK\_GP213 is the master configuration serial clock signal of TMS320C6748 chip to drive SPI clock input of an AD converter, Texas Instruments ADS1259.

Select *File/Import/IBIS File (\*.ibs)*, select *ads1259.ibs* from *<TINA directory>\Examples\IBIS*. The following dialog will be displayed. In this dialog, you can select the model to import.

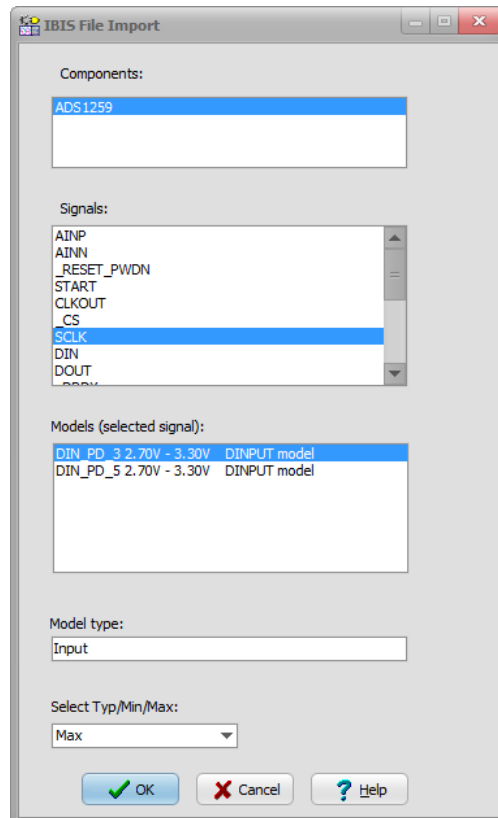

Now select *SCK* input signal, *DIN\_PD\_3* model and *Max* value (for 3.3V DVDD voltage range). Press OK. The IBIS model is automatically converted to a Spice macro.

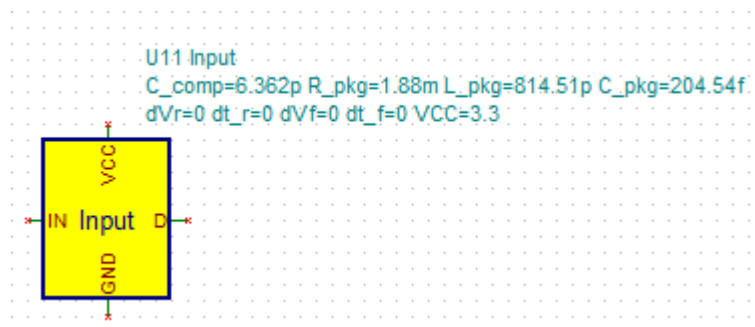

## Using IBIS Models in TINA

Connect the DSP I/O buffer to the input of the ADC with a lossless transmission line. Add the power source and voltage generator to create clock signal of DSP side. Place voltage pins for the simulation onto the signal nodes.

We adjust the transmission line parameters to a few inches of microstrip trace routed on a four-layer PCB. This produces cc. 500ps delay and 90 Ohms characteristic impedance.

File from *<TINA directory>\Examples\IBIS\Impedance matching of TMS320C6748.TSC* is ready to be used.

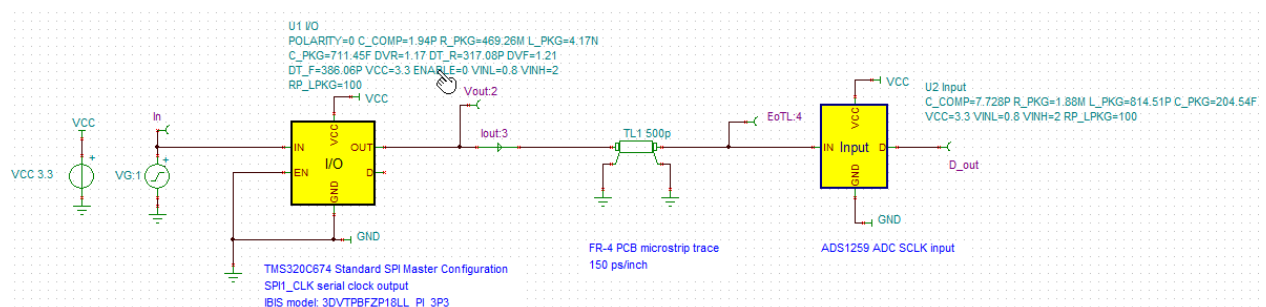

Now, click Analysis, Transient. The DSP transmits the SPI clock signal where the impedance mismatch creates reflections. The result shows the reflections created by the impedance mismatches in this circuit simulation.

At the ADC side (pin EoTL), the voltage is beyond the ground and the supply voltage, which violates the absolute maximum rating of the digital input.

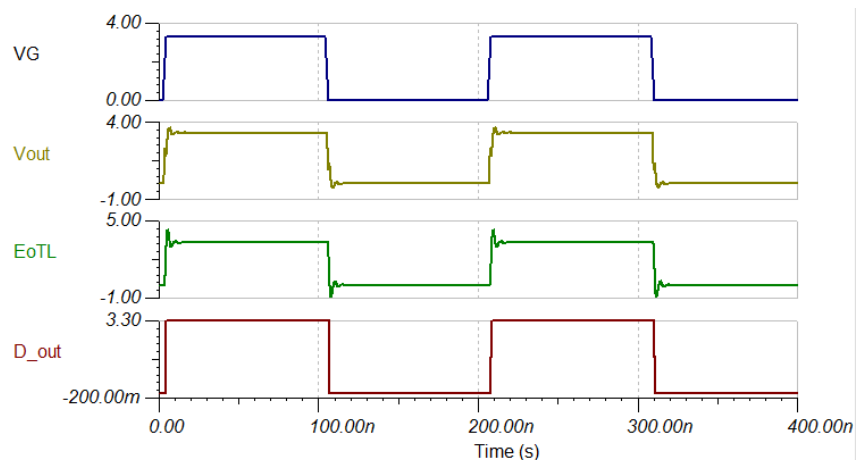

## Using IBIS Models in TINA

To avoid under and overshoots at the line end is to match the output impedance of the driver to the trace impedance by inserting a resistor between the output and the trace. Let us place a 100  $\Omega$  resistor in series now with the output.

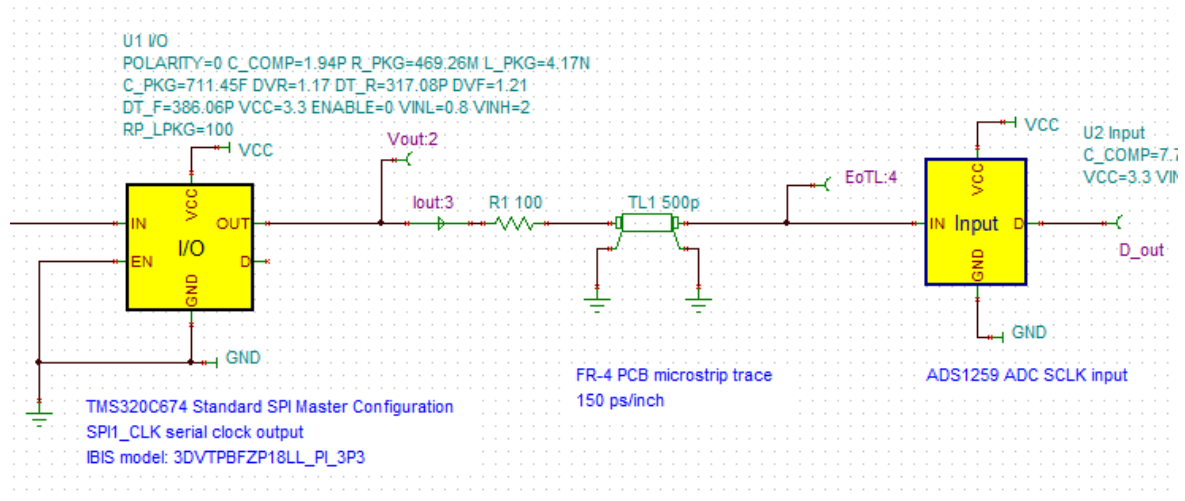

Run the transient analysis again, and compare the results by copying the important curves with each other.

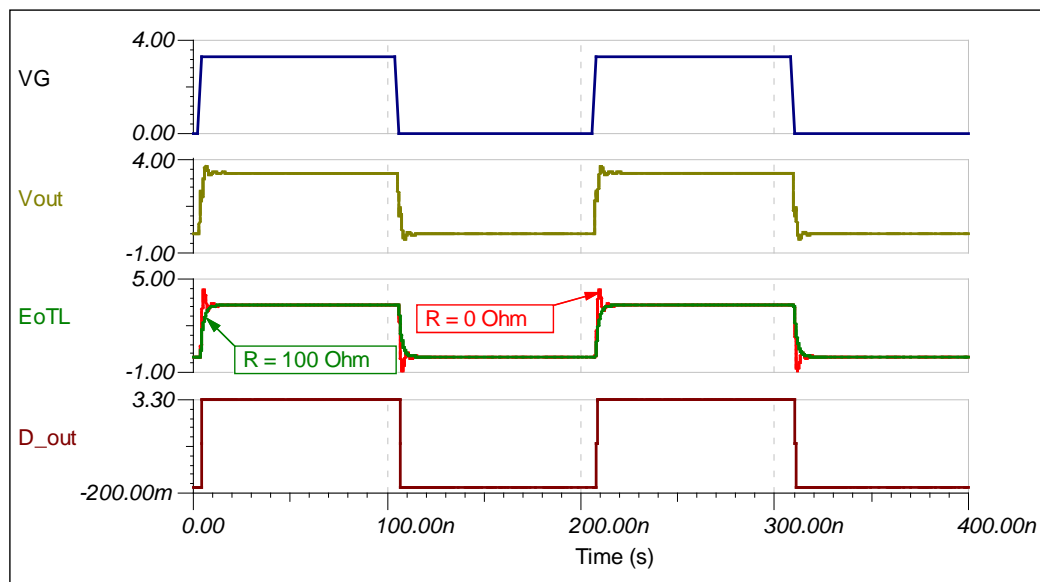

Now, we can see that using the IBIS model to understand and find the critical issues with the simulation helped to solve this problem.