

MIC AMP [OPA313] BOARD DIM

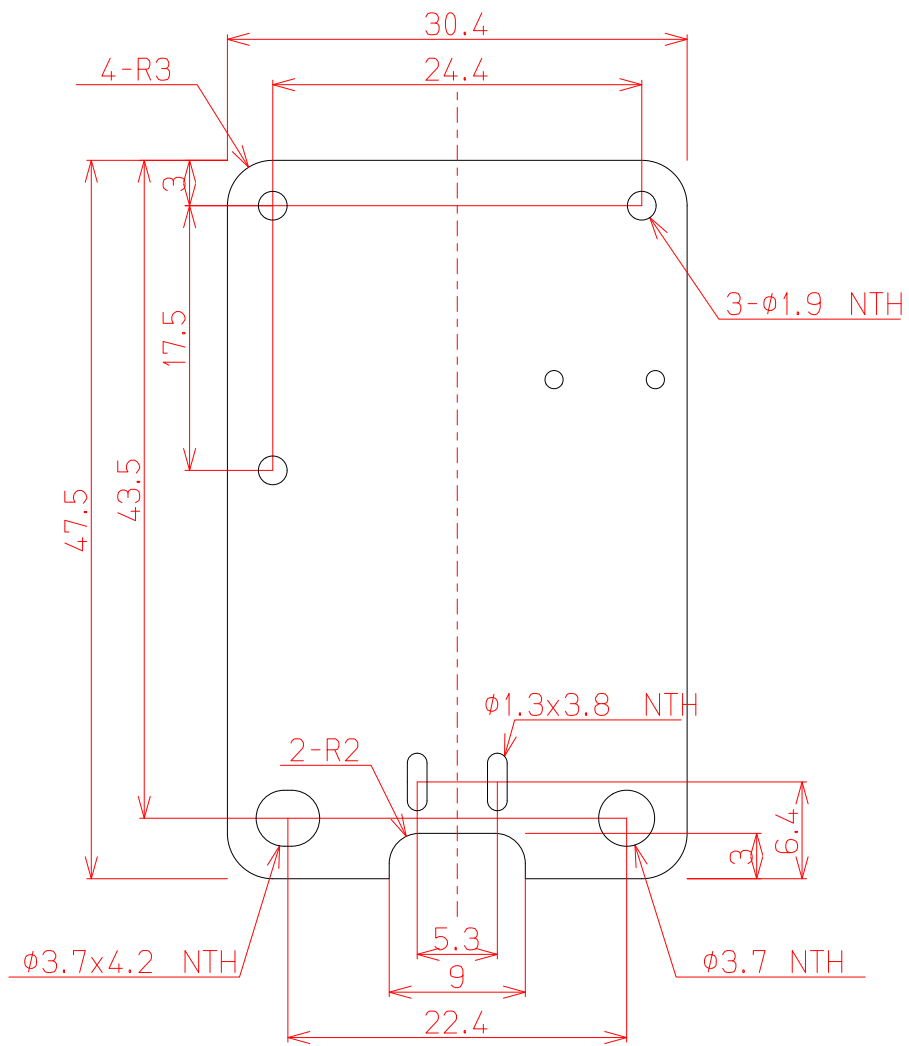

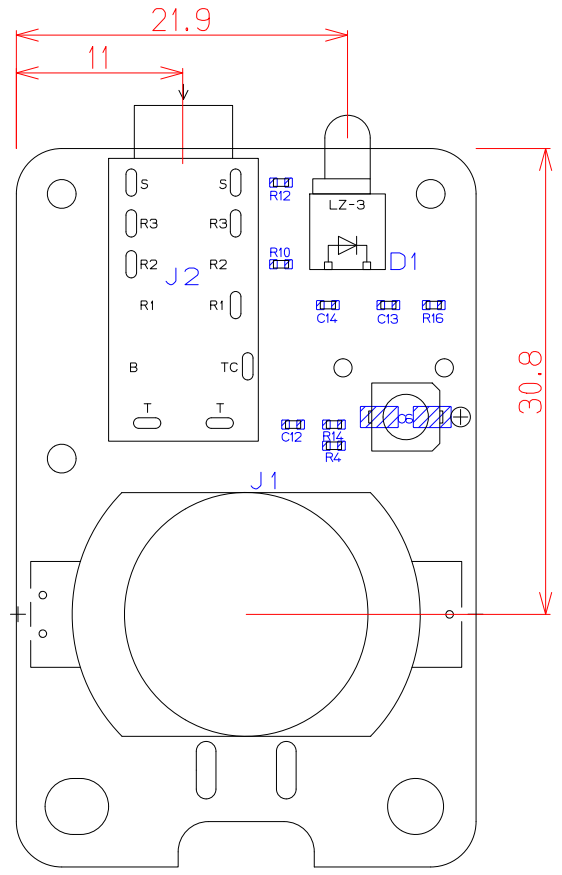

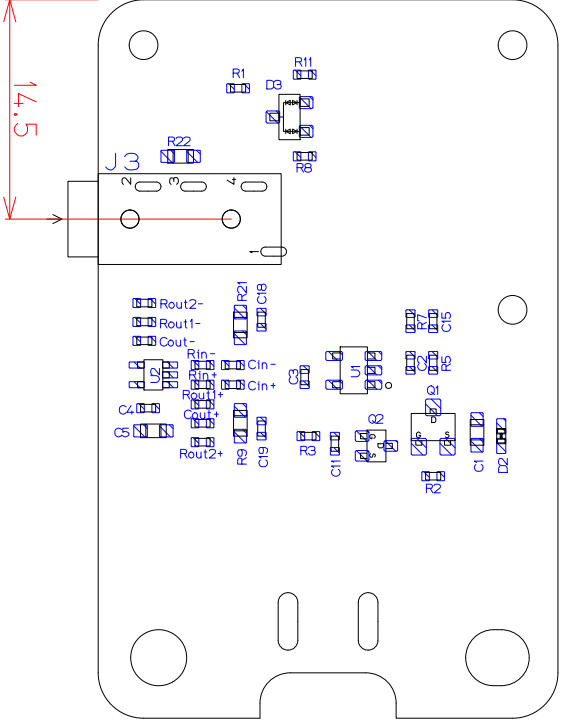

MIC AMP [OPA313] 1/2-PATTERN

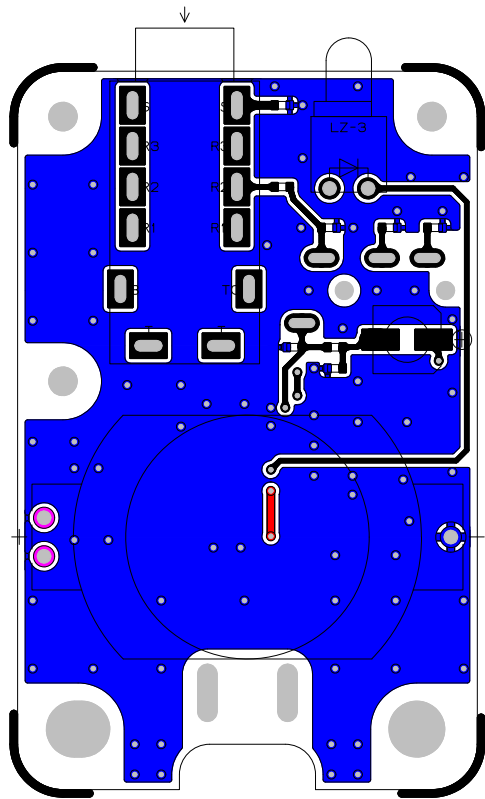

MIC AMP [0PA313] 2x2-PATTERN

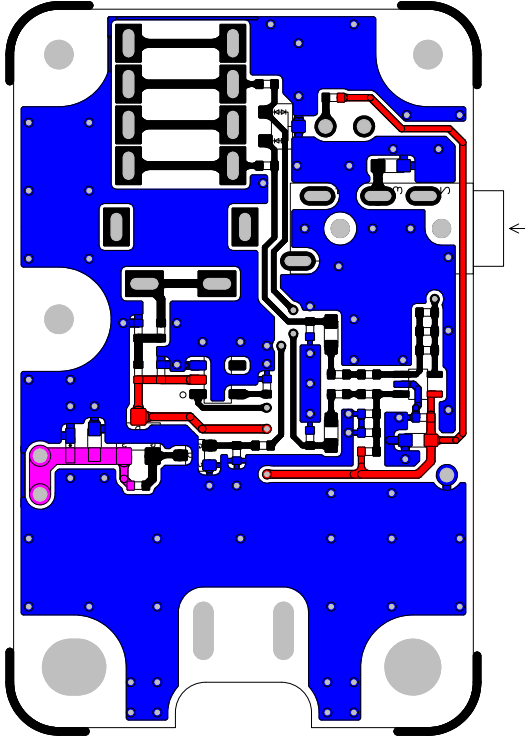

MIC AMP [OPA313] A-SOLDER RESIST

MIC AMP [OPA313] A-SYMBOL PRINT

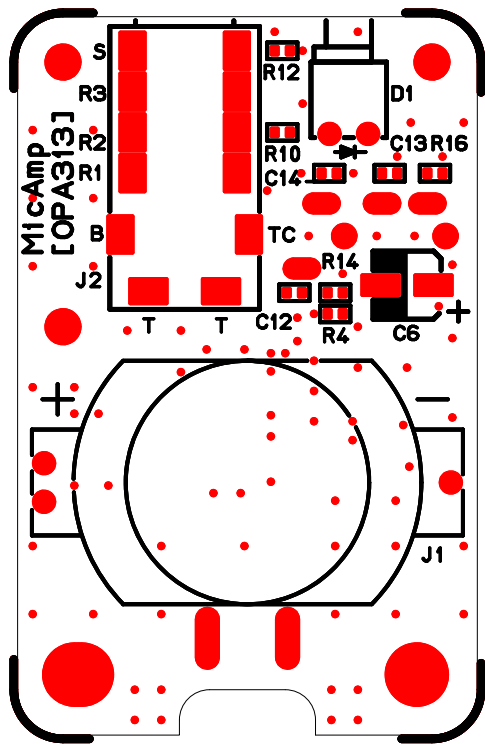

MIC AMP [OPA313] B-SOLDER RESIST

MIC AMP [OPA313] B-SYMBOL PRINT

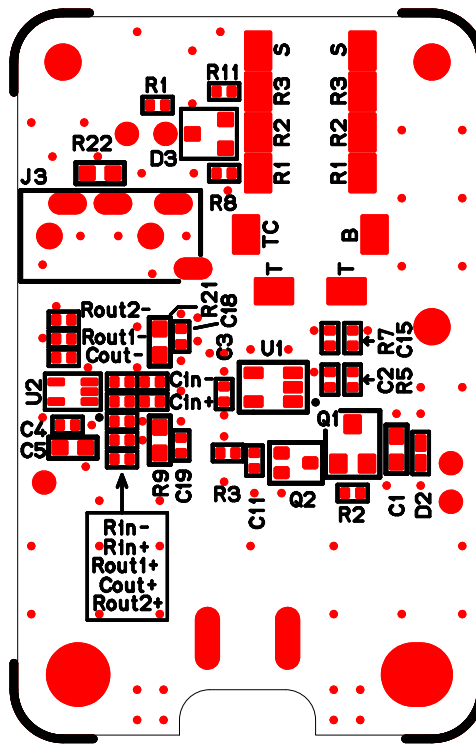

MIC AMP [OPA313]

HOLE LAYOUT

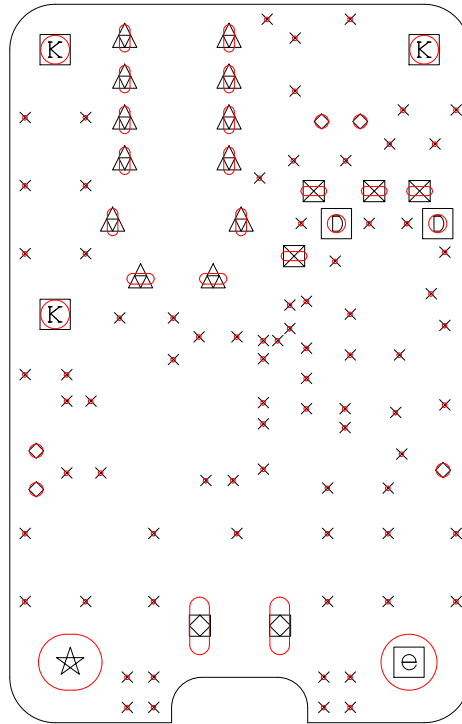

ホール形状	穴径	長さ	メッキ属性	発生文字	合計
丸穴	0.300		メッキあり	x	79
丸穴	0.900		メッキあり	◇	5
丸穴	1.200		メッキなし	D	2
丸穴	1.900		メッキなし	K	3
丸穴	3.700		メッキなし	e	1
長穴	0.600	1.700	メッキあり	⊠	4
長穴	0.700	1.800	メッキあり	△	12
長穴	1.300	3.800	メッキなし	⊞	2
長穴	3.700	4.200	メッキなし	☆	1