

**Sensor : IRA-S210ST01**  
**Lens : IML-0685/0688**



## Pyro Electric Infrared Sensor Fresnel Lens

### Features

- Excellent S/N
- Low voltage operation available

### Applications

- Intrusion Detectors
- Lighting Automation

Please select IML-0685 or IML-0688 depend on your application and target detection area

### What is Pyro-electric infrared sensor.

Pyro electric infrared sensor is used the pyroelectric effect of pyro-electric ceramic which is a kind of piezo-electric ceramic.

Pyro-electric effect is a phenomenon such as;

When the temperature of pyro-electric ceramic is changed, spontaneous polarization of ceramic is changed by the amount of temperature change. Then the amount of electric charge is varied depending on the change of spontaneous polarization. Pyro-electric infrared sensor generates signal output when it detect temperature change of ceramic. On the other hands, pyro-electric infrared sensor does not generate signal output when the temperature of ceramic is stable, this is not depend on the absolute value of temperature.

---

#### Attention:

This datasheet is downloaded from the website of Murata Manufacturing Co., Ltd.  
Therefore, it's specifications are subject to change or our products in it may be discontinued without advance notice.  
Please check with our sales representatives or product engineers before ordering.

## TABLE OF CONTENT

<b>1. What is Pyro-electric infrared sensor .....</b>	<b>1</b>
<b>2. Pyro-electric effect .....</b>	<b>3</b>
<b>3. Optical filter .....</b>	<b>4</b>
<b>4. Pyro-electric infrared sensor function .....</b>	<b>4</b>
4.1 Why optical system is necessary	
4.2 Lens Variation: IML-0685 and IML-0688	
<b>5. Detection Area .....</b>	<b>7</b>
5.1 Output signal against detection area size	
5.2 Element arrangement	
<b>6. PIR sensor Starter Kit : IMX-070 .....</b>	<b>9</b>
6.1 Appearance	
6.2 Circuit diagram of PIR sensor starter kit	
6.3 Frequency response of amplifier	
6.4 Waveform example	
6.5 Note for PCB design	
<b>7. Caution .....</b>	<b>11</b>

---

**Attention:**

This datasheet is downloaded from the website of Murata Manufacturing Co., Ltd.  
Therefore, it's specifications are subject to change or our products in it may be discontinued without advance notice.  
Please check with our sales representatives or product engineers before ordering.

**2. Pyro-electric effect :  
output = behavior electric charge**

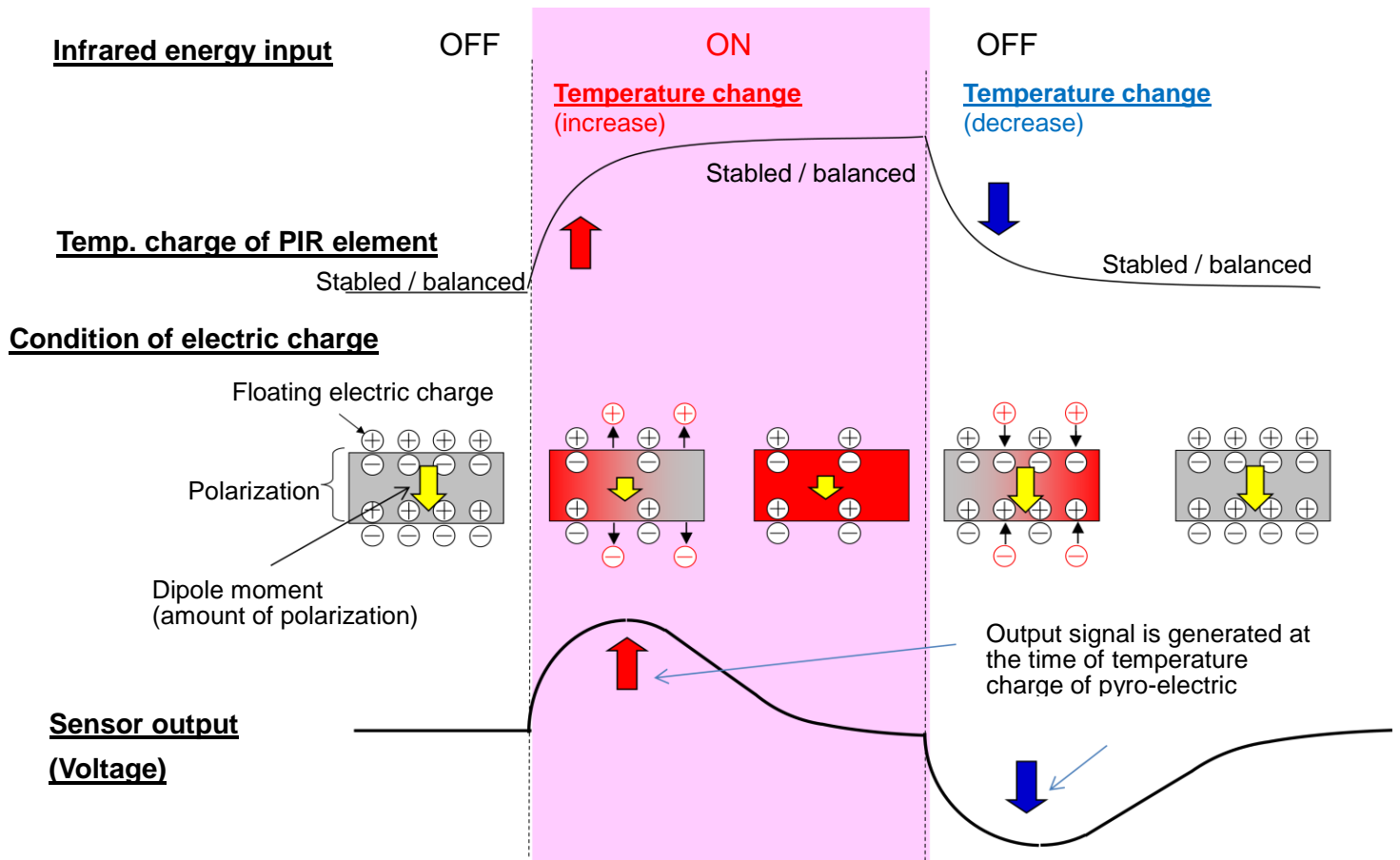

**Attention:**

This datasheet is downloaded from the website of Murata Manufacturing Co., Ltd. Therefore, its specifications are subject to change or our products in it may be discontinued without advance notice. Please check with our sales representatives or product engineers before ordering.

### 3. Optical filter

#### Pyro-electric infrared sensor using optical filter on the top

Optical filter

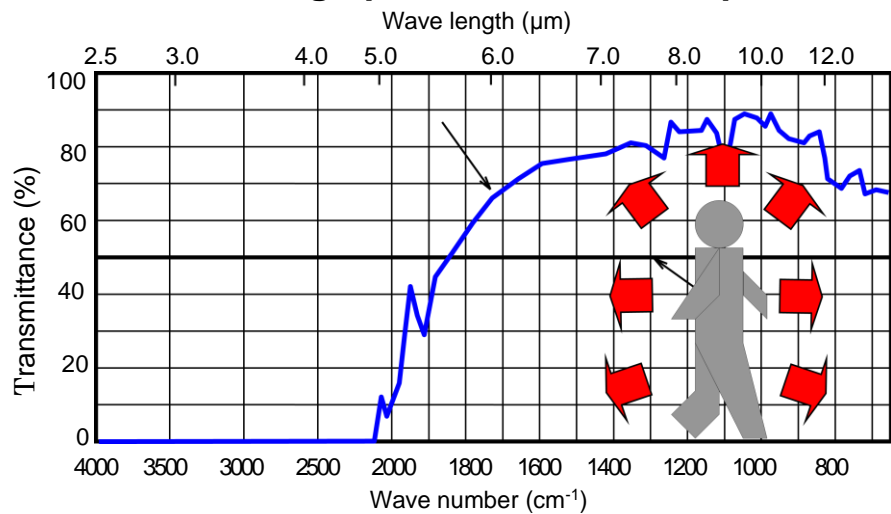

All object emitting infrared ray and the peak wavelength of infrared ray is corresponding to the surface temperature.(This is Wien's law).

However pyro-electric ceramic itself don't have wavelength dependence, so we have to use optical filter which have suitable transmittance to detect target object.

Generally, we use 5um cut-on long pass filter as an optical filter for the application of human body detection, because the peak wavelength of infrared ray emitted from human body is around 10um and 5um cut-on filter has high transmittance around this wavelength.

### 4. Pyro-electric infrared sensor function

#### What is necessary to achieve the motion detection.

	Sensor	Optical system (ex.Lens)	Circuit (Ref. Circuit Diagram)
Products			
Function	Heat ⇒ Electricity 	Area design Angle, Range 	Sensor Signal amplification Signal filtering

**Attention:**

This datasheet is downloaded from the website of Murata Manufacturing Co., Ltd. Therefore, it's specifications are subject to change or our products in it may be discontinued without advance notice. Please check with our sales representatives or product engineers before ordering.

### 4.1 Why optical system is necessary

If don't use optical system in front of sensor,

Directivity of the sensor is as shown in the left figure and the detection area is not formed.

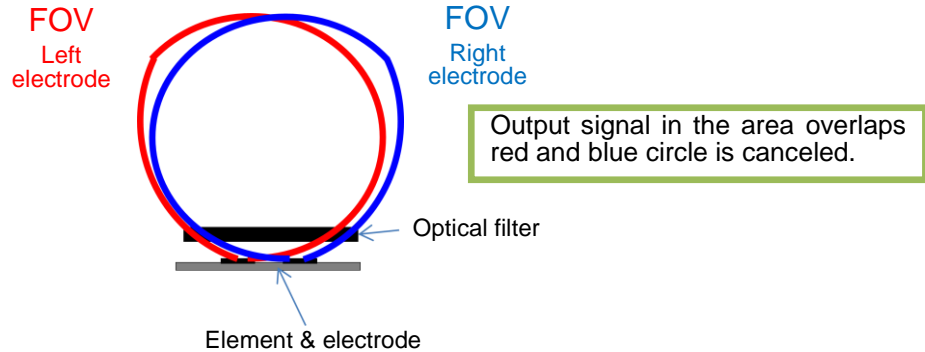

We therefore use optical system to condense the infrared-ray to the element.

**Detection area is designed by the optical system.**

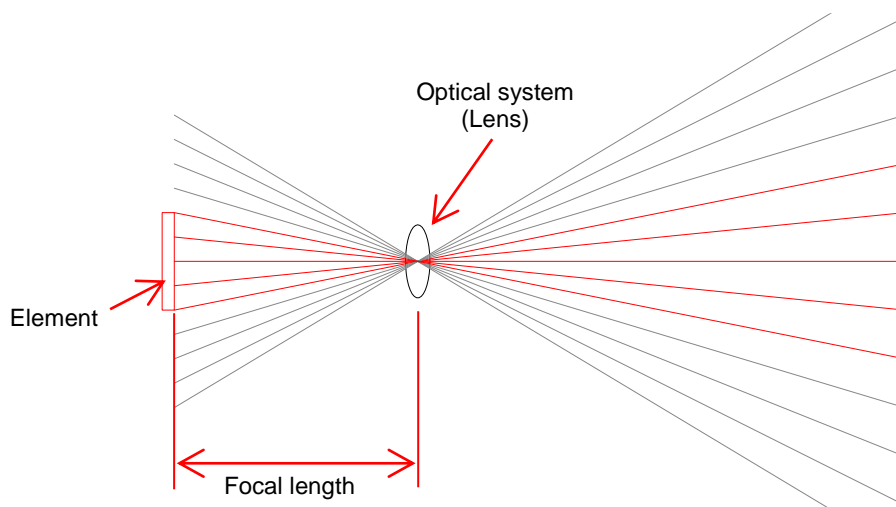
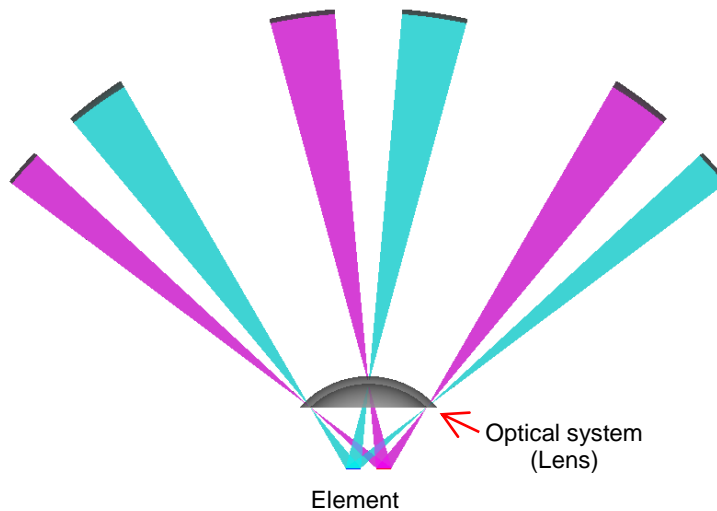

**Attention:**

This datasheet is downloaded from the website of Murata Manufacturing Co., Ltd. Therefore, it's specifications are subject to change or our products in it may be discontinued without advance notice. Please check with our sales representatives or product engineers before ordering.

## 4.2 Lens Variation

### IML-0685 (Inline type)

- mainly used for wall mount unit

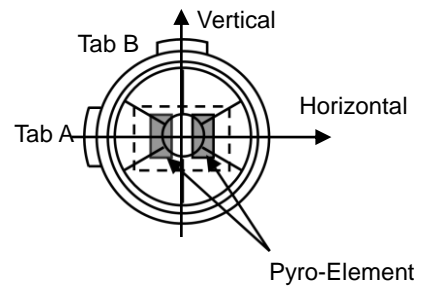
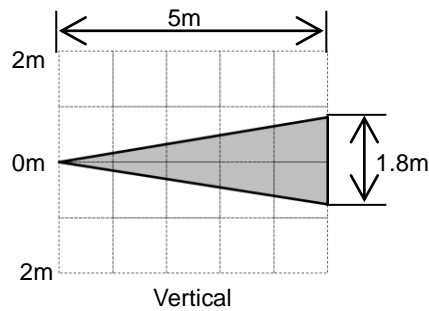
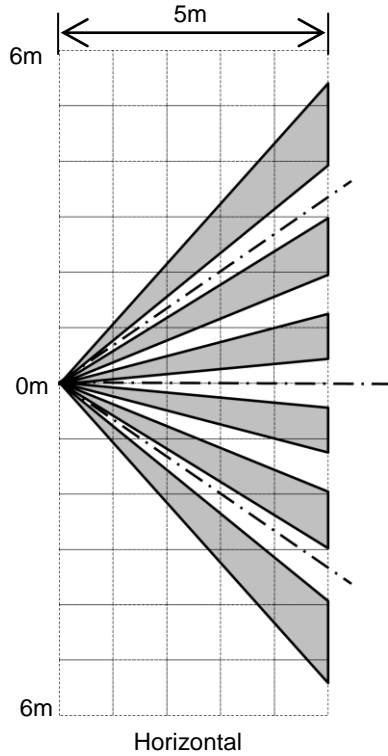

### IML0688 (Round type)

- Mainly used for ceiling mount unit

\*Assembled with Murata sensor  
IRA-S210ST01

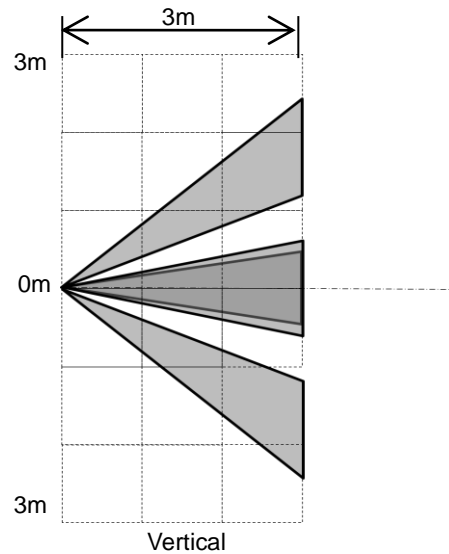
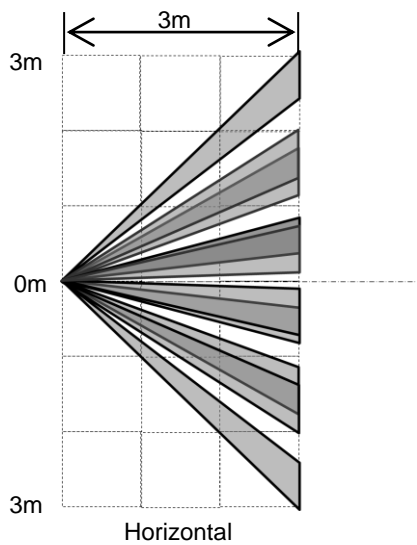

### Attention:

This datasheet is downloaded from the website of Murata Manufacturing Co., Ltd. Therefore, its specifications are subject to change or our products in it may be discontinued without advance notice. Please check with our sales representatives or product engineers before ordering.

## 5. Detection area

The size of detection area is changed by the distance.

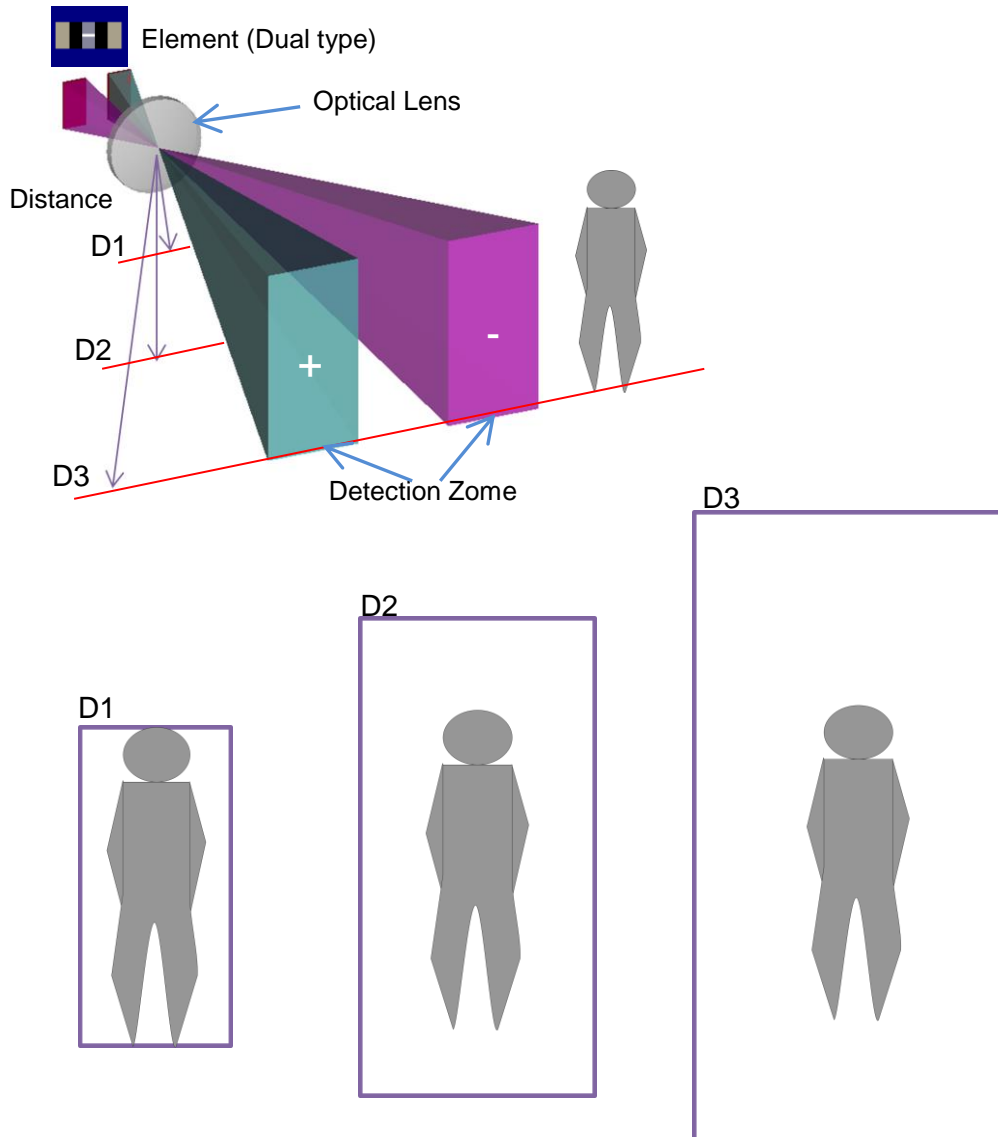

Optical system should be designed by detection distance and detection area which would like to detect human body.

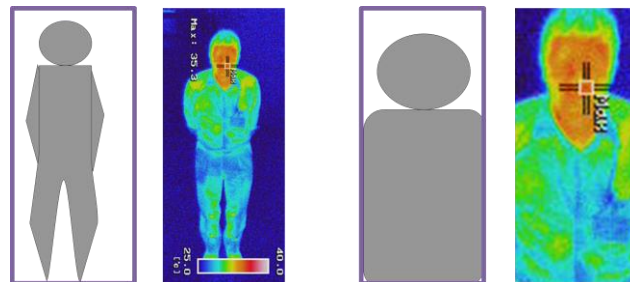

Temperature distribution in the detection area

### Attention:

This datasheet is downloaded from the website of Murata Manufacturing Co., Ltd. Therefore, its specifications are subject to change or our products in it may be discontinued without advance notice. Please check with our sales representatives or product engineers before ordering.

### 5.1 Output signal against detection area size

**Under the condition that the detection distance is same.**

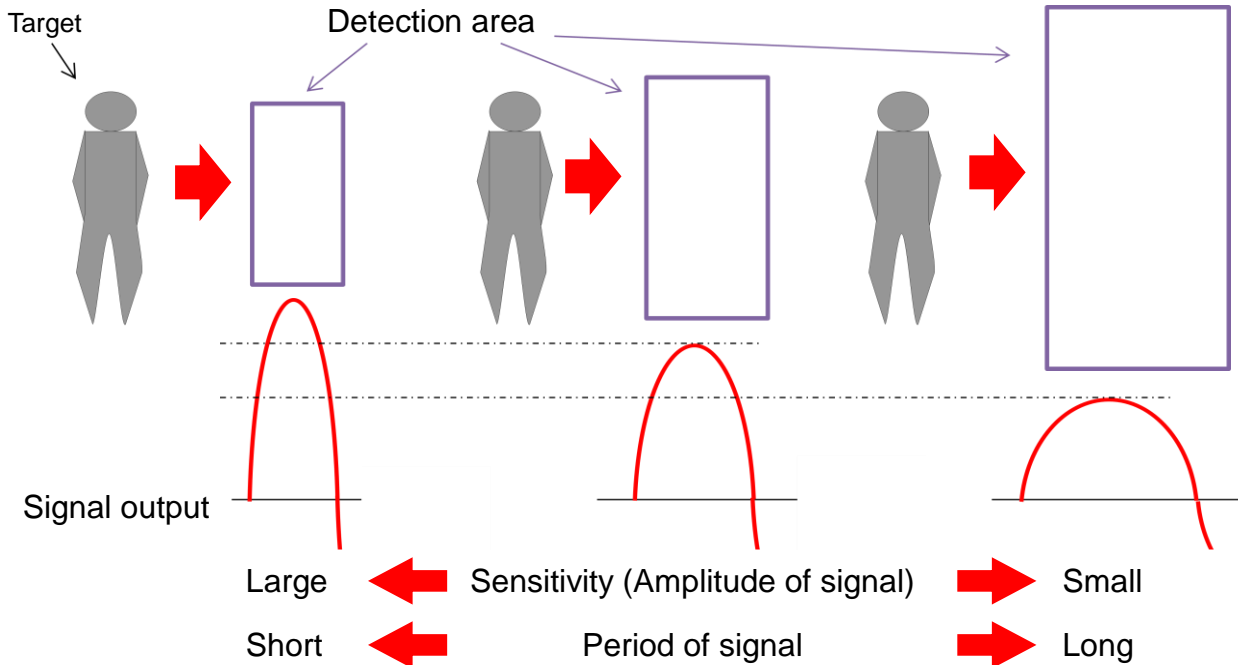

**⚠ Need to adjust the amplification circuit (frequency response and gain)**

### 5.2 Element arrangement

**⚠ Note: Element arrangement**

○ Place the element in horizontal direction in series.

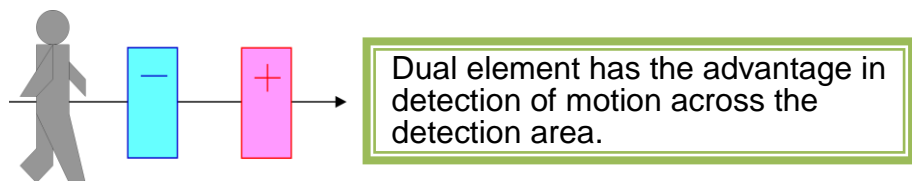

✗ Place the element in vertical direction in series

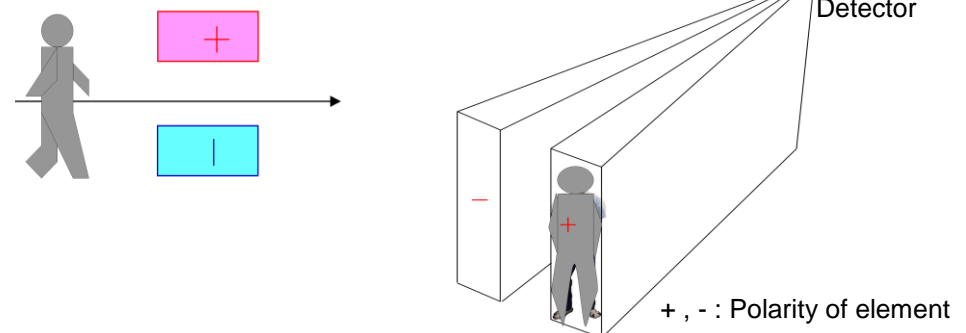

**Attention:**

This datasheet is downloaded from the website of Murata Manufacturing Co., Ltd. Therefore, it's specifications are subject to change or our products in it may be discontinued without advance notice. Please check with our sales representatives or product engineers before ordering.



## 6. PIR sensor starter kit : IMX-070

### 6.1 Appearance

TOP side

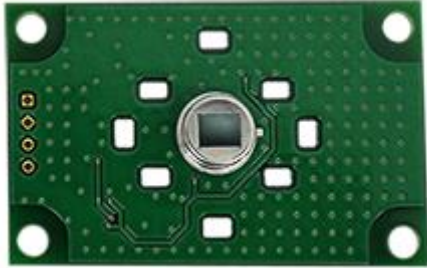

BACK side

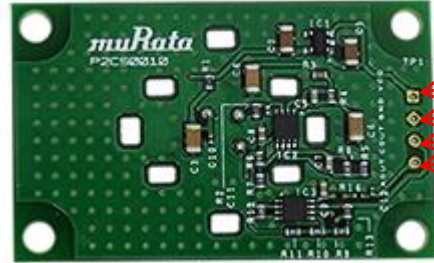

Vcc  
GND  
C-out  
A-out

TOP side with IML-0685 or IML-0688

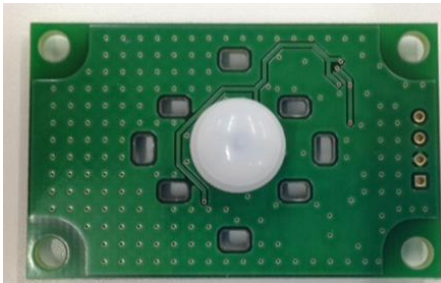

### 6.2 Circuit diagram of PIR sensor starter kit

Vcc=5V±0.5V

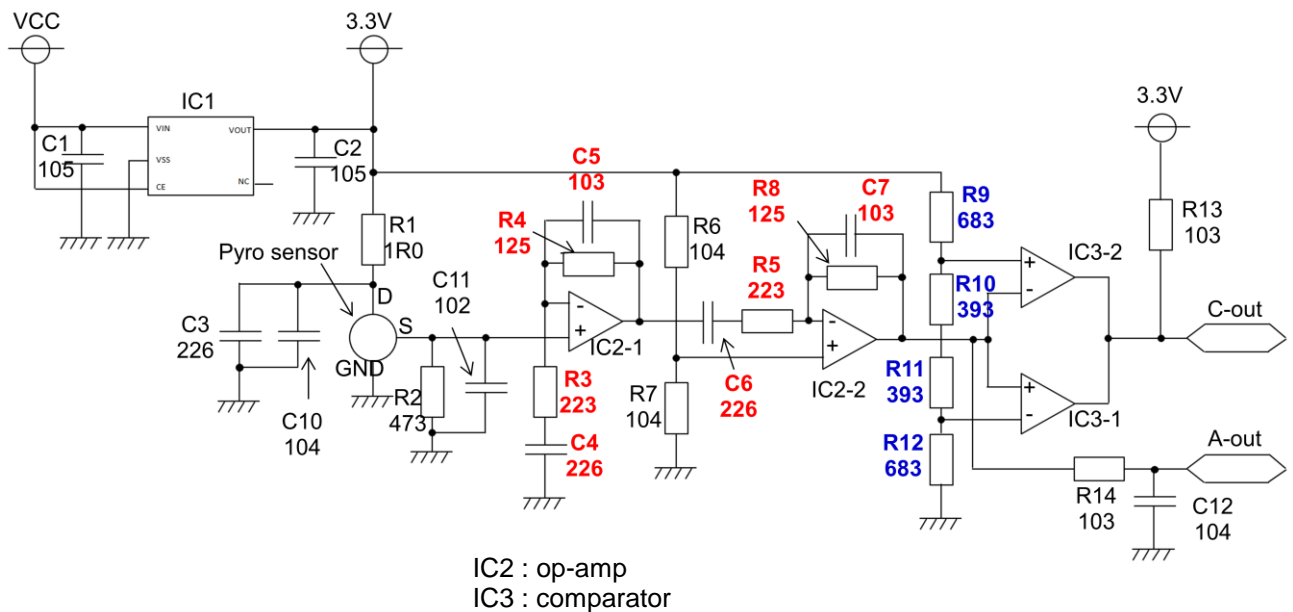

#### Attention:

This datasheet is downloaded from the website of Murata Manufacturing Co., Ltd. Therefore, its specifications are subject to change or our products in it may be discontinued without advance notice. Please check with our sales representatives or product engineers before ordering.

### 6.3 Frequency response of amplifier

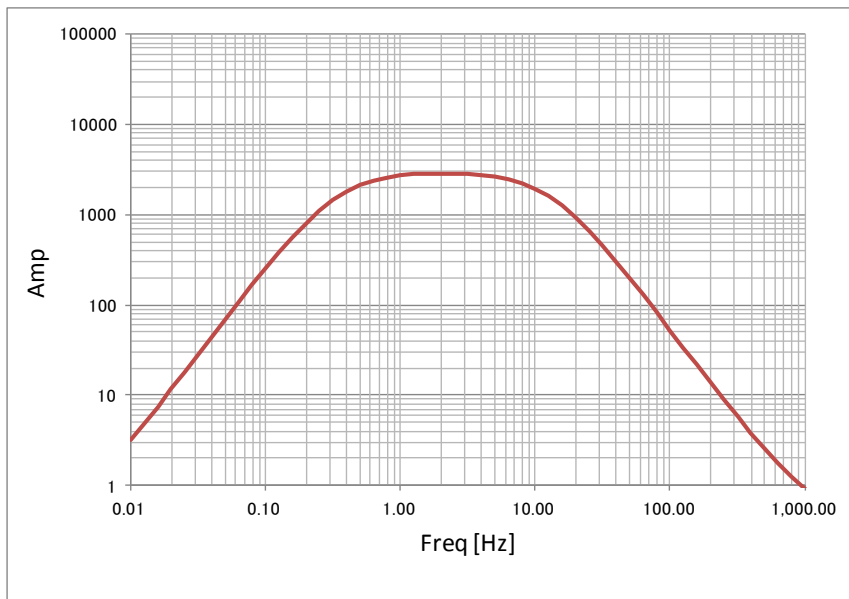

#### Default setting

Amplifier gain : 64.6dB (at 2.0Hz)  
Cut-off frequency (-3dB) : 0.63~6.9Hz

\*To change the frequency response of amplifier

Please change the value of **components shown in red letters** in circuit diagram  
( **R3, R4, R5, R8, C4, C5, C6, C7** )

### 6.4 Waveform example

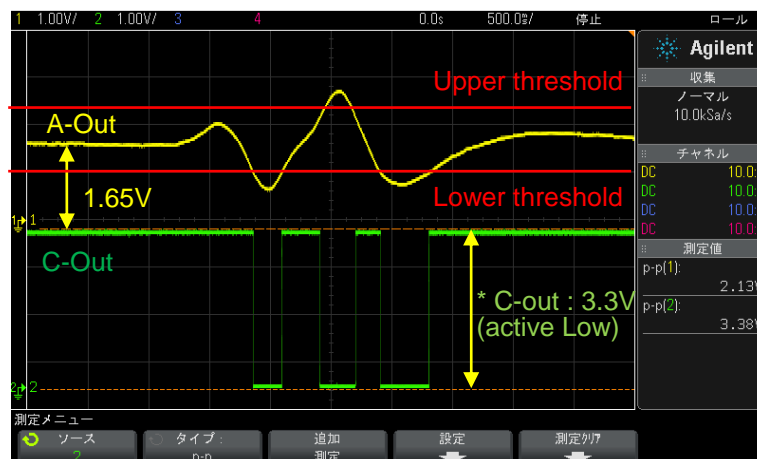

#### Default setting

Upper threshold : 2.25V  
Lower threshold : 1.05V

\*To adjust the threshold level, please change the value of **components shown in blue letters** in circuit diagram ( **R9, R10, R11, R12** )

#### Attention:

This datasheet is downloaded from the website of Murata Manufacturing Co., Ltd.  
Therefore, its specifications are subject to change or our products in it may be discontinued without advance notice.  
Please check with our sales representatives or product engineers before ordering.

### 6.5 Note for PCB design

1. Avoid placing heat-generating components near the pyro sensor.  
(Pyro sensor reacts to heat change and generate output signal.)
2. Voltage regulator should be used as stabilized power supply to pyro sensor and amplifier circuit.  
※To avoid output voltage change due to supply voltage change
3. Rs(resistor between source and ground) should be not so high resistance.
4. Avoid placing RF components near the pyro sensor.  
(e.g. antenna, RF transmitter and module)
5. Wiring pattern should be wide and short.
6. Sufficiently enhancing ground plane.

---

**Attention:**

This datasheet is downloaded from the website of Murata Manufacturing Co., Ltd.  
Therefore, it's specifications are subject to change or our products in it may be discontinued without advance notice.  
Please check with our sales representatives or product engineers before ordering.

## 7. Caution

### ■ Notice in design

- 1) In the case of outdoor use, suitable Optical Filter and water and humidity proof structure should be applied.
- 2) To prevent failure or malfunction, Please use a stabilized power supply.
- 3) Please avoid using the sensor & fresnel lens in the following conditions

because it may cause failure or malfunction ;

- In such a fluid as water, alcohol etc. corrosive gas (SO<sub>2</sub>, Cl<sub>2</sub>, NO<sub>x</sub> etc.) or sea breeze.
- In high humidity.
- In a place exposed directly to sunlight or headlight of automobile.
- In a place exposed to rapid ambient temperature change.
- In a place exposed directly to blow from air-conditioner or heater.
- In a place exposed to strong vibration.
- In a place exposed to strong electromagnetic field.
- In such a place where infrared ray is shaded.
- In such a place are charge field and static electricity field.
- In any other place similar to the above (a) through (i).

※ This application note is downloaded from the website of Murata Manufacturing Co., Ltd.

Therefore, it's specifications are subject to change or our products in it may be discontinued without advance notice.

Please check with our sales representatives or product engineers before ordering.

---

### Attention:

This datasheet is downloaded from the website of Murata Manufacturing Co., Ltd.  
Therefore, it's specifications are subject to change or our products in it may be discontinued without advance notice.  
Please check with our sales representatives or product engineers before ordering.