

Connector

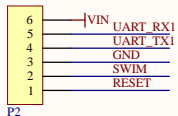

Power 5V-->3.3V

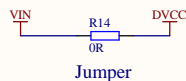
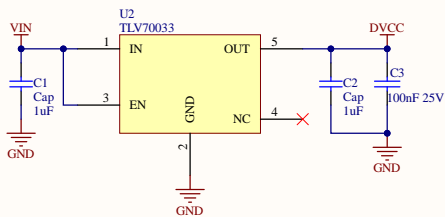

MCU

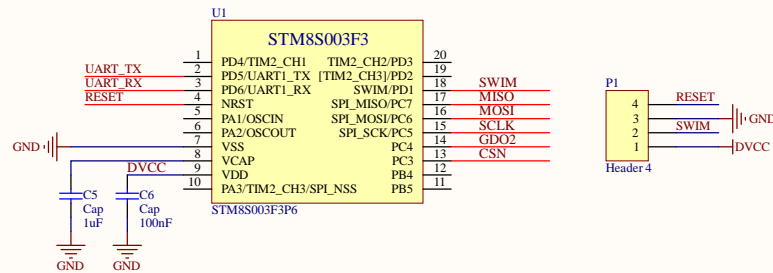

5V IO <--> 3.3V IO

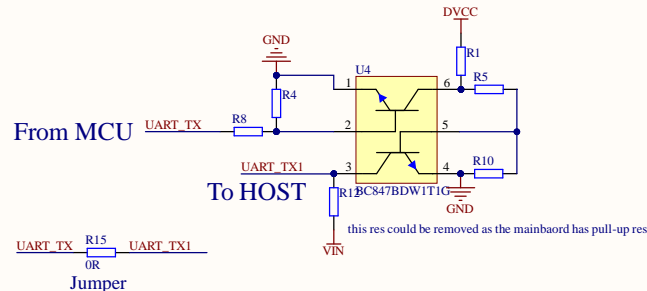
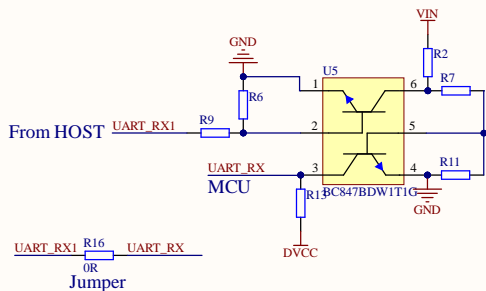

RF_CC113L

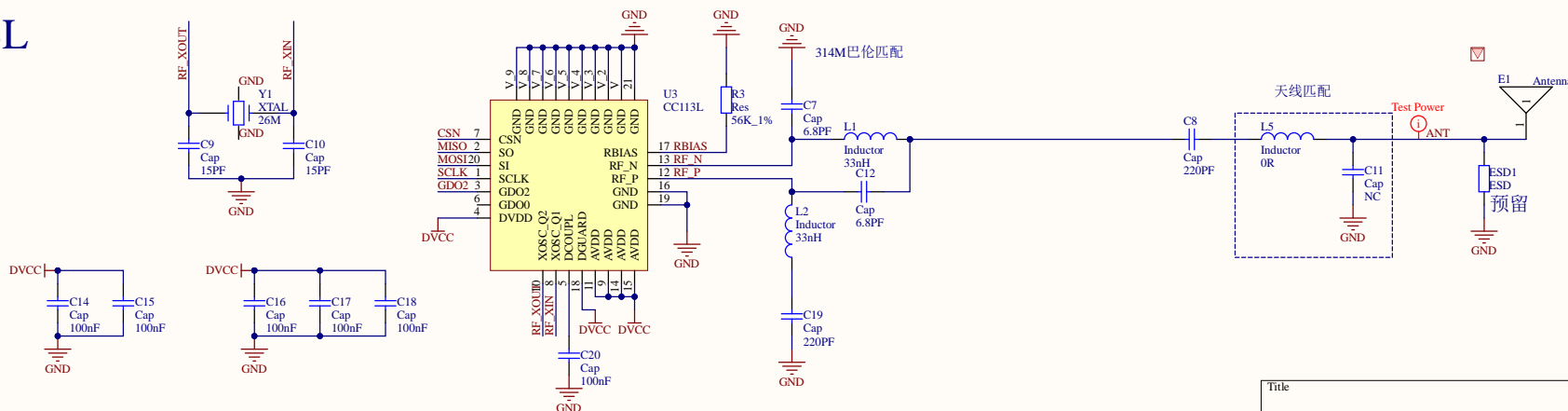

| | | |
|-------|----------------------------|-----------|
| Title | | |
| Size | Number | Revision |
| A3 | | |
| Date: | 2-18-2024 | Sheet of |
| File: | Z:\10 研发部\...\ZBQRM.SchDoc | Drawn By: |