

Coplanar Waveguide
 ALL RF Lines at output shall be
 50 Ohm Line at 1.13mm .4
 GND to 50 Ohm Lines wide 1mm

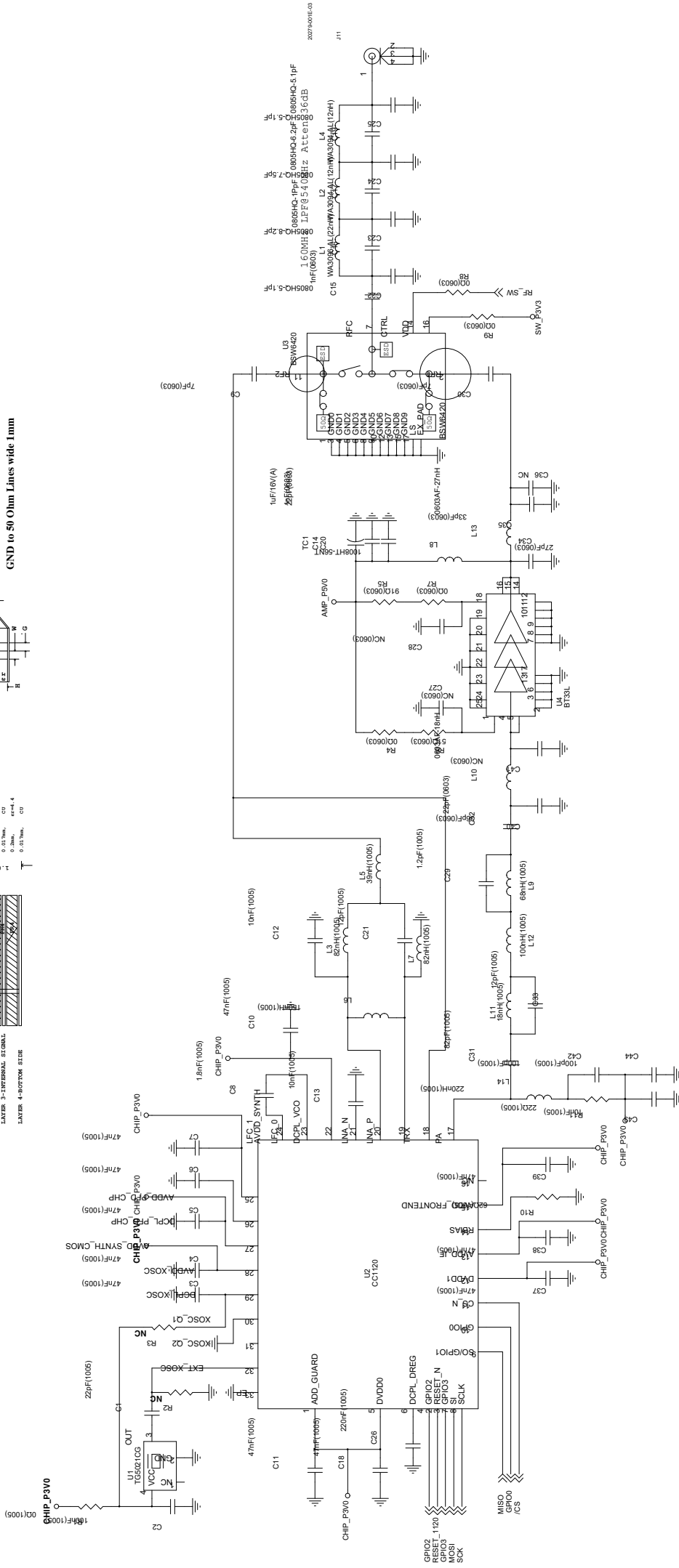
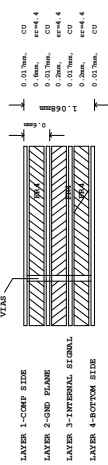
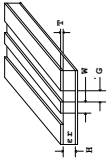

REV.	DWG NO.	DATE	BY	CHKD	APPD	PAGE	TITLE
B	RT425-20220204-S1	2022/02/04	A3			1/2	PACS S/W & Power Amplifier
A							

Radio Communication
 Technology

Rev. DATA / / / / /

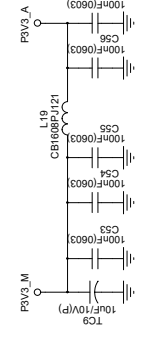
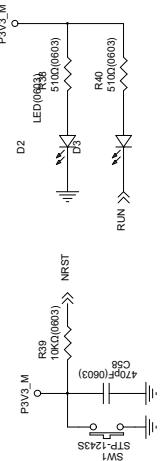
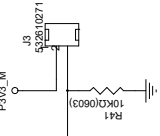
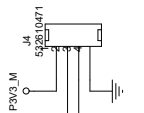
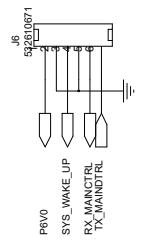
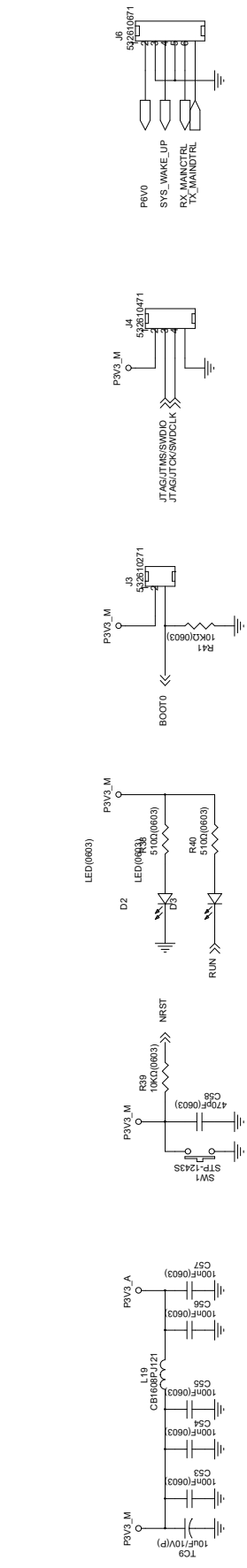
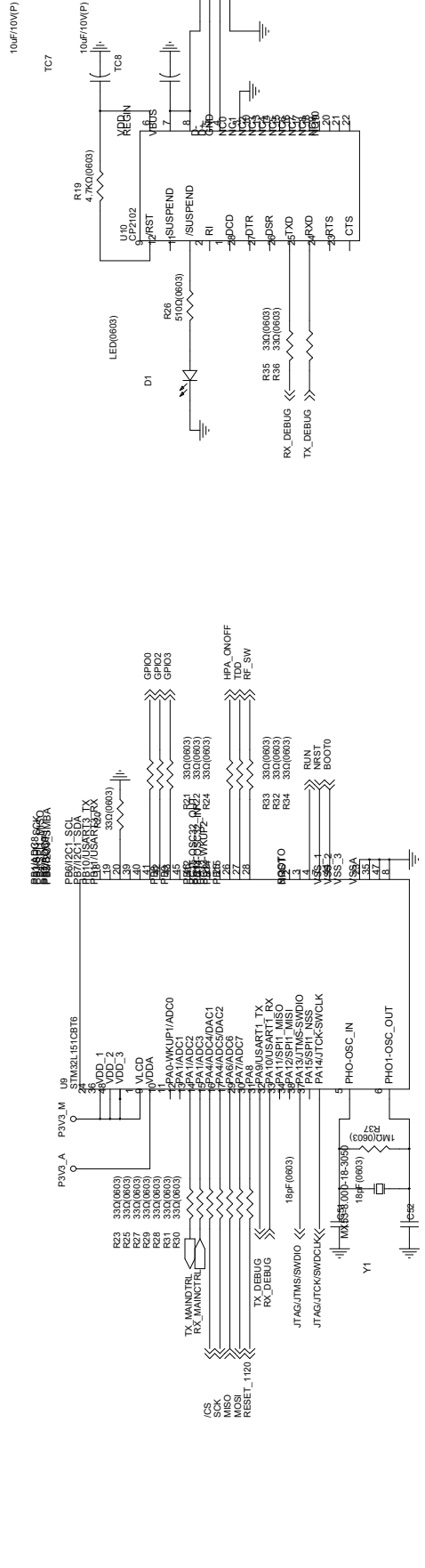
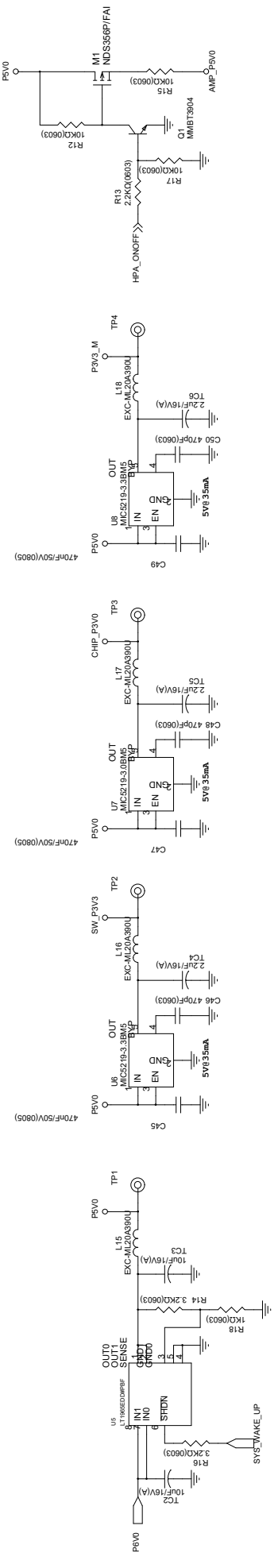

DATA	2022/02/04	SIZE	A3	DESIGN	CHECK	APPRO
D						
C						
B						
A	2022.02					

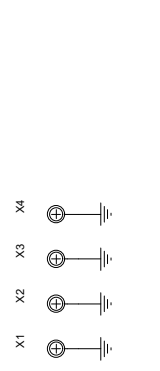

REV.	REV. B
RT425-20220204-S1	
DWG NO.	
TITLE	PACS S/W & Power Amplifier
PAGE	1/2

Radio Communication Technology