

### USB PORT 6

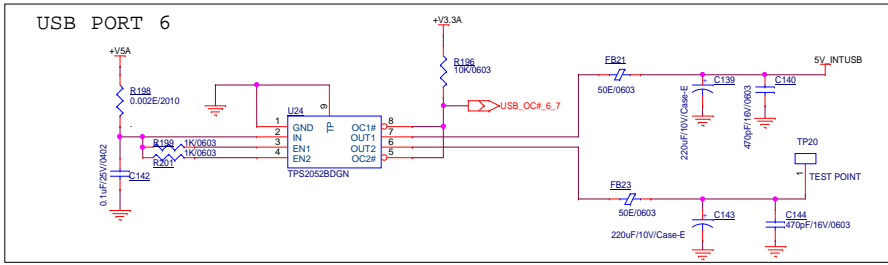

### MC PRGMNG CONN

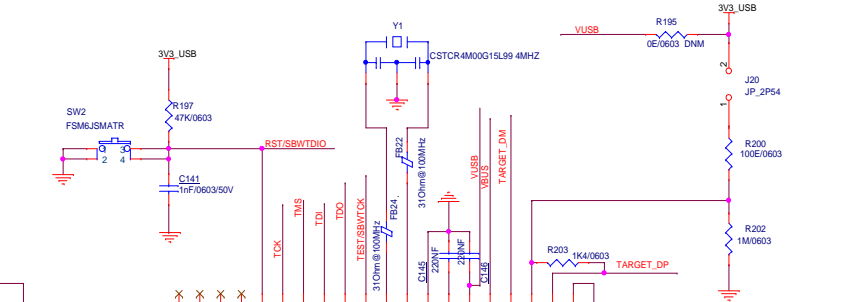
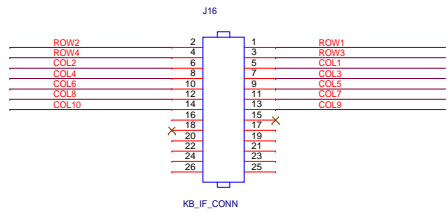
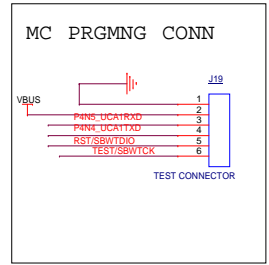

### MICROCONTROLLER JTAG

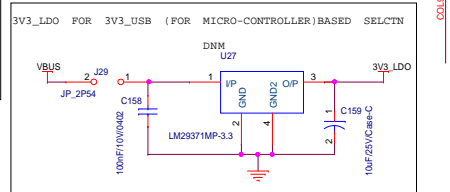
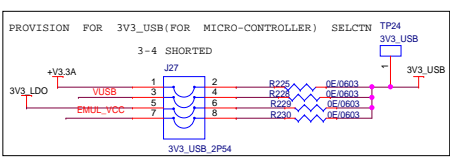
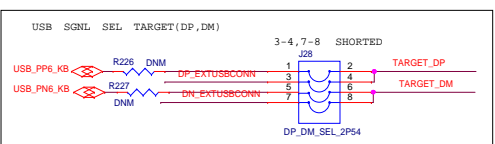
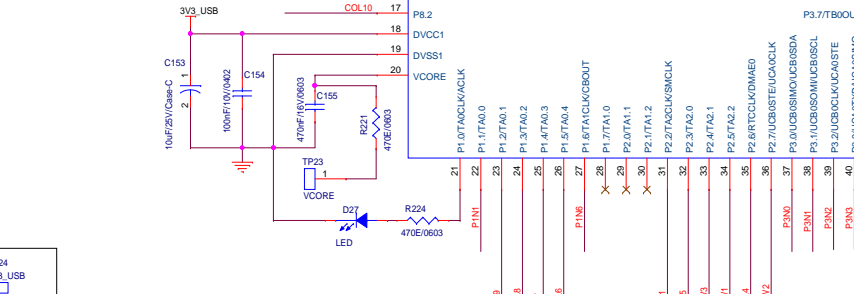
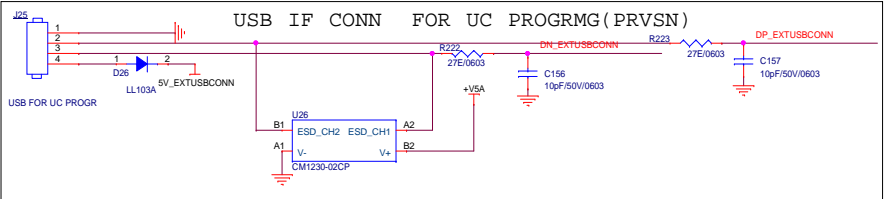
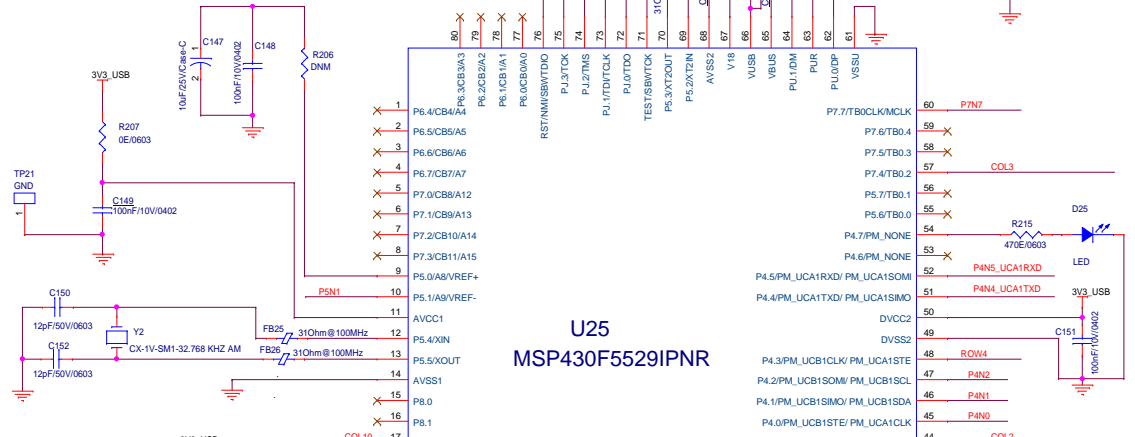
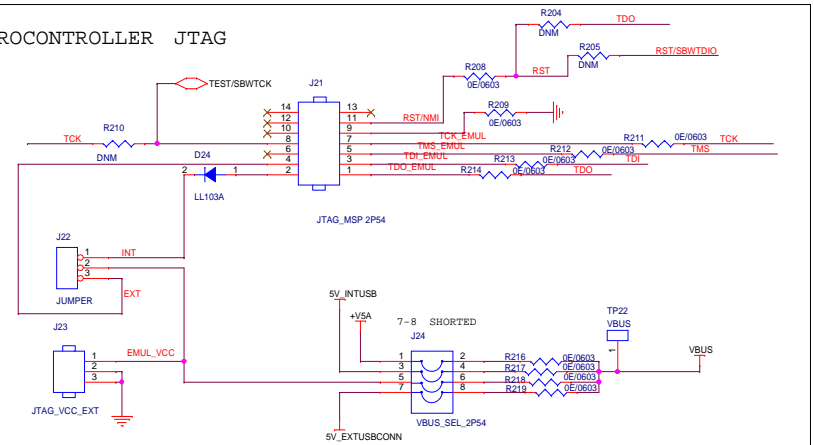

### OPTNL CONN FOR SGNL

