

C2000™ Real-Time Microcontrollers



C2000™ Microcontrollers

Microcontrollers designed for power electronics and precision-sensing applications

The C2000 MCU Advantage

With a 32-bit architecture, DSP processing and advanced control peripherals, the C2000 MCU family enables uncompromising performance for a variety of real-time control applications such as motor control, digital power supplies, solar and renewable energy, LED lighting, power line communications, radar and more.

At the core, C2000 MCUs are based around the TMS320C28x 32-bit DSP core, featuring single-cycle 32×32-bit hardware multiplies and single-cycle atomic instruction execution. Unique, feature-filled peripherals complement the core performance with industry-leading PWM generation, unparalleled ADC conversion, enhanced capture units, and more. Plus, unique architectural designs are incorporated for faster, safer and more effective control systems.

At the heart of C2000 microcontrollers is an application-focused design. Many unique features are included to improve performance of power electronics applications. This application focus is further extended with development kits for C2000 MCUs, where extensive kit selections are offered for motor control, digital power, solar energy, LED lighting and power line communications to accelerate development.

Further easing and speeding development, C2000 MCUs include a vast collection of software libraries, both device-specific and application-specific, to make it easy to begin developing optimized software and hardware solutions.

C2000 MCUs are *the* control solution. Check out one of our Piccolo™, Delfino™, or Concerto™ families to find the right MCU for *your* control application.

C2000 MCU Families:



Piccolo™ Microcontrollers

Real control. Real time. For real systems.

Highly-integrated microcontrollers for real-time control of cost-sensitive power electronics applications. With control-optimized performance, specialized peripherals, and a control-focused architecture, Piccolo MCUs bring innovative solutions to demanding control challenges.

Starting at **U.S. \$1.50**

Packages from
38 to 100 pins



Delfino™ Microcontrollers

High performance. For high-end control.

The leading microcontroller family for high-performance control needs. With up to 300-MHz performance, industry-leading PWM control resolution, and blazing ADC conversion speeds, Delfino MCUs tackle the toughest control challenges.

Starting at **U.S. \$8.95**

Packages from
176 to 256 pins

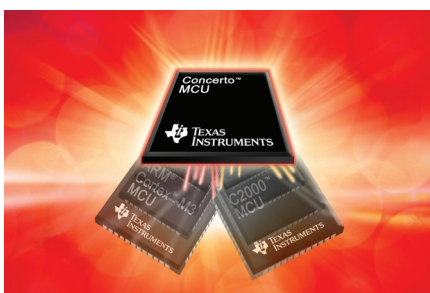

Concerto™ Microcontrollers

Connectivity. Control. No compromise.

Differentiated microcontroller family combining the ARM® Cortex™-M3 core with C2000's C28x core in a single MCU package. Concerto MCUs bring together leading host communications and leading real-time control without compromise of control performance or communications.

Starting at **U.S. \$6.71**

Packages from
144 pins

DSP performance, MCU ease

DSP core with control focused co-processor and accelerator options to provide unparalleled performance and flexibility for a variety of applications

- 32-bit C28x DSP architecture
- Modified Harvard architecture including six separate data/address buses for data and program memory
- Eight-stage pipeline with single-cycle operation across pipeline
- Native DSP math processing with single-cycle 32×32 -bit multiply accumulate (MAC) operations and dual 16×16 MACs
- 96 interrupt vectors with low-latency service routines down to nine cycles
- Floating-point unit options across portfolio and revolutionary IQMath™ floating-point software for fixed-point devices
- C28x CLA co-processor for dual-core architectures, doubled performance, and modular control systems
- VCU Accelerator for unparalleled communications processing
- Best-in-class compiler efficiency
- Software compatibility across the portfolio

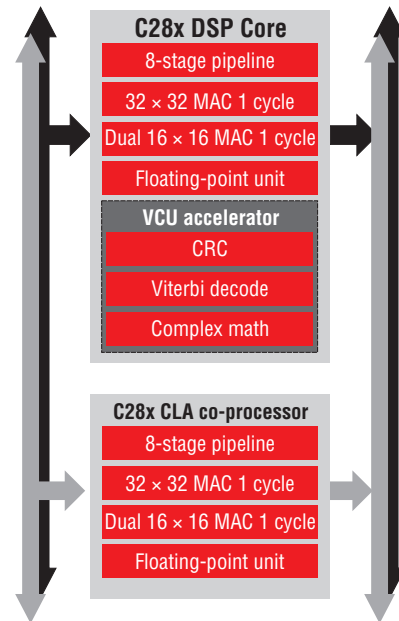

C2000 MCU Processing Engine:
C28x core, VCU accelerator and CLA co-processor

Take control with C2000 MCU peripherals

Most flexible, configurable, and highest performing in their class

PWM generation:

- Achieve unprecedented precision with unparalleled high-resolution duty-cycle control down to 55ps time steps
- Reduce power-switching losses with high-resolution and configurable deadband support
- Protect your system and add safety features with direct PWM tripping from comparator or trip zone pin inputs
- Flexible PWM outputs configurations, including dual-edge asymmetric and symmetric PWM generation
- Programmable or hardware-locked PWM time and phase synchronization

ADC feedback:

- 12-bit resolution for high accuracy
- Dual sample-and-hold circuitry to enable simultaneous, zero-delay dual sampling
- Ultra-fast ADC sample and conversion rates up to 12.5 mega samples per second (MSPS)

Capture and Quadrature Encoder interfaces:

- Highly accurate capture interfaces based on 32-bit timers with additional capabilities for high-resolution measurements
- 32-bit quadrature encoder pulse module for interfacing with incremental encoders used in motor control systems

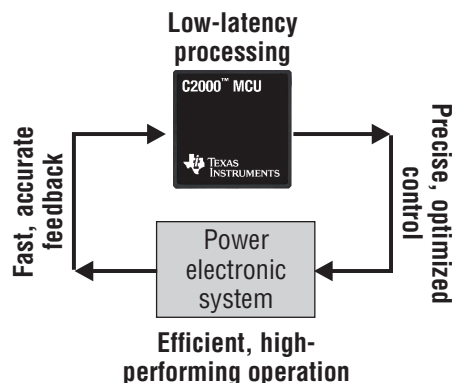
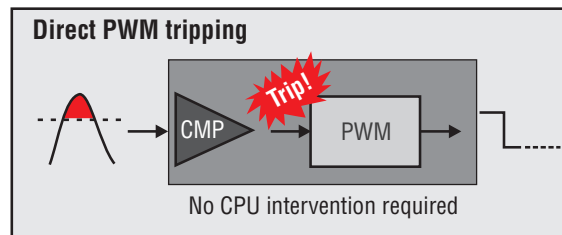
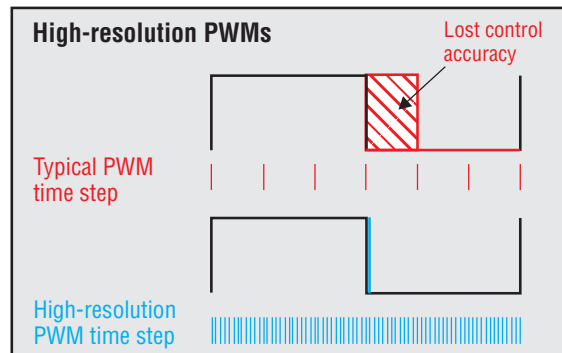

C2000 MCUs complete the loop

Piccolo™ Microcontrollers

Low-cost microcontrollers for real-time control applications such as white goods appliances, industrial drives, pumps, HVAC systems, solar inverters, digital power supplies, LED lighting, battery charging and power line communications.

See why Piccolo microcontrollers' combination of performance, control-oriented architecture, and low cost make them the ideal control solution for power electronics.

Powerful performance

C28x core, CLA co-processor, and VCU accelerator solve your toughest control challenges

- Up to 180 MIPS* of total performance with the 32-bit C28x DSP core combined with the CLA co-processor
- No need to hassle with fixed-point arithmetic, use an integrated floating-point unit or the IQMath™ engine
- Accelerate advanced communications-based algorithms by up to 7× with the VCU accelerator

Control-focused peripherals

Reduce power usage, enjoy more precise control, and just simply do more

- Experience a new level of control precision with the industry's leading PWM resolution on a low-cost device
- Run faster and more accurate control loops with a 4.6 MSPS, 12-bit ADC and high-resolution PWMs
- Reduce power-switching losses with high-resolution PWM dead-band
- Synchronize PWM generation by phase or time offset to create more advanced systems
- See why C2000 PWMs are the most powerful and flexible in the industry

CLA co-processor solutions

A new approach to system modularity, safety, and performance

- Run parallel control loops with independent operation of the CLA co-processor and C28x core, both have independent access to control peripherals
- Run multiple motors, motor plus power factor correction, LED lighting plus power line communications and more
- Implement safety standards with dual-core redundancy, cross-checking of computational results, and verification of peripheral functioning

* On select devices

Piccolo™ F2802x/F2803x/F2805x/F2806x series			
Processing C28x 32-bit core Up to 90 MHz CLA co-processor Up to 90 MHz VCU accelerator Floating-point unit	Memory Flash Up to 256 KB SRAM Up to 100 KB Security zones 128-bit Boot ROM CRC	Power & Clocking 2× 10-MHz Osc 4–20 MHz Ext Osc 3.3-V VREG POR/BOR	System 6-ch. DMA Watchdog timers 3× 32b CPU timers 96 interrupt PIE Real-time JTAG
Analog 12-bit ADC Up to 4.6 MSPS Up to 3× comp. w/ DAC Temp. sensor	Control & Timers 8× PWM modules 16 ch. 8× HRPWM Fault trip zones Up to 7× HRCAP Up to 2×eQEP	Communications 3× UART I ² C 2× SPI CAN 2.0 USB McBSP LIN	

Starting at U.S. \$1.50

Q100 qualified and 125°C temperature support

On select devices

Control-tuned architecture

The integration you need with the features to differentiate your application from the competition.

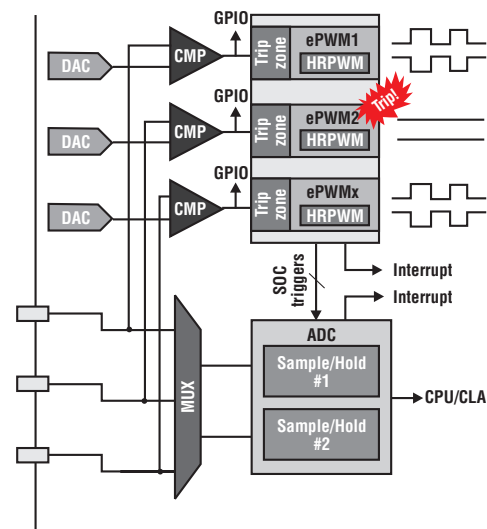

- Simultaneously sample multiple motor phases or concurrent voltage and current values with a dual sample-and-hold ADC
- Add protection to your system with asynchronous PWM direct tripping through on-chip analog comparators
- Reduce Bill of Materials (BOM) costs through integrated analog comparators with DACs
- Simplify control with partitioned systems split between the C28x core and CLA co-processor, each has independent access to all control peripherals
- Forget about device life support hassles with on-chip power-on-reset (POR), brown-out-reset (BOR), clock fail detect and back-up oscillators

TMS320C2000™ Microcontrollers																																
Device	Processor					Memory			Control Interfaces								Communication Ports							External memory interface	Core supply (V)	GPIO pins	On-chip oscillator	Voltage regulator	Package pin counts	1 KU pricing (U.S. \$)		
	Speed (MHz)	FPU	CLA co-processor	VCU accelerator	DMA	Flash (KB)	RAM (KB)	ROM (KB)	PWM ch.	High-resolution PWM ch.	Quadrature encoder	Event captures	HRCAP	Timers*	12-bit ADC ch.	ADC conversion time (ns)	Comparators	OpAmp/PGA	USB	McBSP	PC	UART/SCI	SPI								CAN	LIN
Piccolo™ MCU generation																																
TMS320F2802x MCUs																																
TMS320F280220	40	-	-	-	-	16	6	Boot	7	-	-	1	-	8	13	1000	-	-	-	-	1	1	1	-	-	-	3.3	22	2	Yes	38, 48	1.50
TMS320F280230	40	-	-	-	-	32	8	Boot	7	-	-	1	-	8	13	1000	-	-	-	-	1	1	1	-	-	-	3.3	22	2	Yes	38, 48	1.62
TMS320F280260	50	-	-	-	-	16	6	Boot	7	-	-	1	-	8	13	800	-	-	-	-	1	1	1	-	-	-	3.3	22	2	Yes	38, 48	2.08
TMS320F280270	50	-	-	-	-	32	8	Boot	7	-	-	1	-	8	13	800	2	-	-	-	1	1	1	-	-	-	3.3	22	2	Yes	38, 48	2.23
TMS320F280200	40	-	-	-	-	16	6	Boot	9	-	-	-	-	8	13	500	2	-	-	-	1	1	1	-	-	-	3.3	22	2	Yes	38, 48	1.85
TMS320F28020	40	-	-	-	-	32	6	Boot	9	-	-	1	-	9	13	500	2	-	-	-	1	1	1	-	-	-	3.3	22	2	Yes	38, 48	1.99
TMS320F28021	40	-	-	-	-	64	10	Boot	9	-	-	1	-	9	13	500	2	-	-	-	1	1	1	-	-	-	3.3	22	2	Yes	38, 48	2.20
TMS320F28022	50	-	-	-	-	32	12	Boot	9	-	-	1	-	9	13	260	2	-	-	-	1	1	1	-	-	-	3.3	22	2	Yes	38, 48	2.25
TMS320F28023	50	-	-	-	-	64	12	Boot	9	4	-	1	-	9	13	260	2	-	-	-	1	1	1	-	-	-	3.3	22	2	Yes	38, 48	2.45
TMS320F28026	60	-	-	-	-	32	12	Boot	9	4	-	1	-	9	13	217	2	-	-	-	1	1	1	-	-	-	3.3	22	2	Yes	38, 48	2.65
TMS320F28027	60	-	-	-	-	64	12	Boot	9	4	-	1	-	9	13	217	2	-	-	-	1	1	1	-	-	-	3.3	22	2	Yes	38, 48	2.85
TMS320F2803x MCUs																																
TMS320F28030	60	-	-	-	-	32	12	Boot	15	-	1	1	1	12	16	500	3	-	-	-	1	1	2	1	1	-	3.3	44	2	Yes	56, 64, 80	2.79
TMS320F28031	60	-	-	-	-	64	16	Boot	15	-	1	1	1	12	16	500	3	-	-	-	1	1	2	1	1	-	3.3	44	2	Yes	56, 64, 80	2.97
TMS320F28032	60	-	-	-	-	64	20	Boot	15	7	1	1	1	12	16	217	3	-	-	-	1	1	2	1	1	-	3.3	44	2	Yes	56, 64, 80	3.49
TMS320F28033	60	-	Yes	-	-	64	20	Boot	15	7	1	1	1	12	16	217	3	-	-	-	1	1	2	1	1	-	3.3	44	2	Yes	56, 64, 80	4.11
TMS320F28034	60	-	-	-	-	128	20	Boot	15	7	1	1	1	12	16	217	3	-	-	-	1	1	2	1	1	-	3.3	44	2	Yes	56, 64, 80	3.75
TMS320F28035	60	-	Yes	-	-	128	20	Boot	15	7	1	1	1	12	16	217	3	-	-	-	1	1	2	1	1	-	3.3	44	2	Yes	56, 64, 80	4.41
TMS320F2806x MCUs																																
TMS320F28062	90	Yes	-	-	Yes	128	52	Boot	19	8	2	7	4	17	16	325	3	-	1	1	1	2	2	1	-	-	3.3	54	2	Yes	80, 100	4.95
TMS320F28063	90	Yes	-	-	Yes	128	68	Boot	19	8	2	7	4	17	16	325	3	-	1	1	1	2	2	1	-	-	3.3	54	2	Yes	80, 100	5.40
TMS320F28064	90	Yes	-	Yes	Yes	128	100	Boot	19	8	2	7	4	17	16	325	3	-	1	1	1	2	2	1	-	-	3.3	54	2	Yes	80, 100	6.20
TMS320F28065	90	Yes	Yes	Yes	Yes	128	100	Boot	19	8	2	7	4	17	16	325	3	-	1	1	1	2	2	1	-	-	3.3	54	2	Yes	80, 100	7.10
TMS320F28066	90	Yes	-	-	Yes	256	68	Boot	19	8	2	7	4	17	16	325	3	-	1	1	1	2	2	1	-	-	3.3	54	2	Yes	80, 100	6.20
TMS320F28067	90	Yes	-	-	Yes	256	100	Boot	19	8	2	7	4	17	16	325	3	-	1	1	1	2	2	1	-	-	3.3	54	2	Yes	80, 100	6.60
TMS320F28068	90	Yes	-	Yes	Yes	256	100	Boot	19	8	2	7	4	17	16	325	3	-	1	1	1	2	2	1	-	-	3.3	54	2	Yes	80, 100	7.00
TMS320F28069	90	Yes	Yes	Yes	Yes	256	100	Boot	19	8	2	7	4	17	16	325	3	-	1	1	1	2	2	1	-	-	3.3	54	2	Yes	80, 100	7.90

*Timers include CPU timers, PWM timers, eCAP timers and Watchdog timers

†Prices are quoted in U.S. dollars and represent 2012 suggested retail pricing for baseline packages and device configurations. All prices are subject to change.

Delfino™ Microcontrollers

High-performance, floating-point microcontrollers for applications such as industrial power electronics, inverters, digital power supplies, power delivery, solar and wind energy, radar and smart sensing.

See why Delfino microcontrollers are built to handle the toughest control challenges.

Uncompromising performance

Over 600 MFLOPs of floating-point performance will do the job

- 32-bit C28x core with up to 600 MFLOPs of floating-point performance at 300-MHz operating frequency
- Native floating-point support eliminates the hassle of fixed-point development – likewise, porting code between fixed- and floating-point native devices is a snap with the IQMath™ virtual floating-point engine
- Get DSP performance in an MCU-class device with the C28x core and enjoy single-cycle 32×32 MAC or 16×16 dual-MAC operations
- Eliminate the need for a second processor with a single core that is efficient at both the DSP math tasks and microcontroller system control tasks

Architected for speed and precision

Streamlined design to make your applications more responsive

- Simultaneously sample multiple motor phases or concurrent voltage and current values with a dual sample-and-hold ADC
- Sample system parameters more frequently and more accurately with a 12.5-MSPS 12-bit ADC
- Get more efficiency and responsiveness out of your systems with unparalleled high-resolution PWM duty cycle edge placement down to 55ps time unit increments
- Create safer and more responsive systems with ultra-fast PWM tripping, allowing PWM shutdown or drive high/low conditions in as little as 20ns
- Reduce processing latency with Direct Memory Access (DMA) control peripherals, McBSP and memory peripherals
- Get more accuracy for speed and other time-sensitive sensing with responsive event capture units (6.67ns)

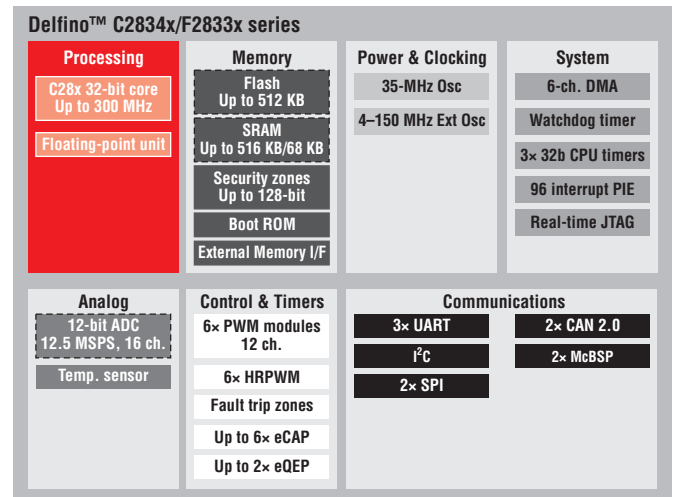

Starting at **U.S. \$8.95**

Q100 qualified and **125°C** temperature support

On select devices

F2833x/C2834x – two device options

Your choice of RAM or Flash-based device configurations for your performance and integration needs

- The C2834x series provides utmost processing and memory performance as well as flexibility to choose analog components to fit your system performance needs
- The F2833x series provides large Flash and analog integration for systems requiring MCU integration and non-compromising high performance

TMS320C2834x/TMS320F2833x device differences		
	TMS320C2834x	TMS320F2833x
Maximum clock speed	300 MHz	150 MHz
Memory type	SRAM	Flash
Memory capacity	516 KB	512 KB
ADC	External interface	12.5-MSPS 12-bit ADC
Max PWM resolution	55ps	150ps

TMS320C2000™ Microcontrollers																																
Device	Processor					Memory			Control Interfaces								Communication Ports							External memory interface (bit)	Core supply (V)	GPIO pins	On-chip oscillator	Voltage regulator	Package pin counts	1 KU pricing (U.S. \$)		
	Speed (MHz)	FPU	CLA co-processor	VCU accelerator	DMA	Flash (KB)	RAM (KB)	ROM (KB)	PWM ch.	High-resolution PWM ch.	Quadrature encoder	Event captures	HRCAP	Timers*	12-bit ADC ch.	ADC conversion time (ns)	Comparators	OpAmp/PGA	USB	McBSP	PC	UART/SCI	SPI								CAN	LIN
Delfino™ MCU generation																																
TMS320F2833x MCUs																																
TMS320F28335	150	Yes	-	-	Yes	512	68	Boot	18	6	2	6	-	16	16	80	-	-	-	2	1	3	1	2	-	16/32	1.9	88	1	-	176, 179	14.25
TMS320F28334	150	Yes	-	-	Yes	256	68	Boot	16	6	2	4	-	14	16	80	-	-	-	2	1	3	1	2	-	16/32	1.9	88	1	-	176, 179	14.05
TMS320F28332	100	Yes	-	-	Yes	128	52	Boot	16	4	2	4	-	14	16	80	-	-	-	1	1	2	1	2	-	16/32	1.9	88	1	-	176, 179	13.20
TMS320C2834x MCUs																																
TMS320C28346	300	Yes	-	-	Yes	-	516	Boot	24	9	3	6	-	19	-	-	-	-	-	2	1	3	2	2	-	16/32	1.2	88	1	-	256	16.40
TMS320C28345	200	Yes	-	-	Yes	-	516	Boot	24	9	3	6	-	19	-	-	-	-	-	2	1	3	2	2	-	16/32	1.1	88	1	-	179, 256	14.45
TMS320C28344	300	Yes	-	-	Yes	-	260	Boot	24	9	3	6	-	19	-	-	-	-	-	2	1	3	2	2	-	16/32	1.2	88	1	-	256	12.80
TMS320C28343	200	Yes	-	-	Yes	-	260	Boot	24	9	3	6	-	19	-	-	-	-	-	2	1	3	2	2	-	16/32	1.1	88	1	-	179, 256	11.25
TMS320C28342	300	Yes	-	-	Yes	-	196	Boot	16	6	2	4	-	14	-	-	-	-	-	1	1	3	2	2	-	16/32	1.2	88	1	-	256	10.20
TMS320C28341	200	Yes	-	-	Yes	-	196	Boot	16	6	2	4	-	14	-	-	-	-	-	1	1	3	2	2	-	16/32	1.1	88	1	-	179, 256	8.95

*Timers include CPU timers, PWM timers, eCAP timers and Watchdog timers

†Prices are quoted in U.S. dollars and represent 2012 suggested retail pricing for baseline packages and device configurations. All prices are subject to change.

Fixed-point microcontrollers

C2000 also has an extensive line of fixed-point microcontrollers with various performance and feature set offerings to meet requirements for a variety of real-time control applications.

TMS320C2000™ Microcontrollers																																
Device	Processor					Memory			Control Interfaces								Communication Ports							External memory interface (bit)	Core supply (V)	GPIO pins	On-chip oscillator	Voltage regulator	Package pin counts	1 KU pricing (U.S. \$)		
	Speed (MHz)	FPU	CLA co-processor	VCU accelerator	DMA	Flash (KB)	RAM (KB)	ROM (KB)	PWM ch.	High-resolution PWM ch.	Quadrature encoder	Event captures	HRCAP	Timers*	12-bit ADC ch.	ADC conversion time (ns)	Comparators	OpAmp/PGA	USB	McBSP	PC	UART/SCI	SPI								CAN	LIN
Fixed-Point MCU generation																																
TMS320F2823x MCUs																																
TMS320F28235	150	-	-	-	Yes	512	68	Boot	18	6	2	6	-	16	16	80	-	-	-	2	1	3	1	2	-	16/32	1.9	88	1	-	176, 179	13.85
TMS320F28234	150	-	-	-	Yes	256	68	Boot	16	6	2	4	-	14	16	80	-	-	-	2	1	3	1	2	-	16/32	1.9	88	1	-	176, 179	13.05
TMS320F28232	100	-	-	-	Yes	128	52	Boot	16	4	2	4	-	14	16	80	-	-	-	1	1	2	1	2	-	16/32	1.9	88	1	-	176, 179	12.25
TMS320F281x MCUs																																
TMS320F2812	150	-	-	-	-	256	36	Boot	16	-	2	6	-	8	16	80	-	-	-	1	-	2	1	-	-	16	1.9	56	1	-	176, 179	14.25
TMS320F2811	150	-	-	-	-	256	36	Boot	16	-	2	6	-	8	16	80	-	-	-	1	-	2	1	-	-	1.9	56	1	-	128	14.05	
TMS320F2810	150	-	-	-	-	128	36	Boot	16	-	2	6	-	8	16	80	-	-	-	1	-	2	1	-	-	1.9	56	1	-	128	13.20	
TMS320F280x MCUs																																
TMS320F2809	100	-	-	-	-	256	36	Boot	16	6	2	4	-	14	16	80	-	-	-	-	1	2	4	2	-	-	1.8	35	1	-	100	12.30
TMS320F28044	100	-	-	-	-	128	20	Boot	16	16	-	4	-	24	16	80	-	-	-	-	1	1	1	-	-	-	1.8	35	1	-	100	9.95
TMS320F2808	100	-	-	-	-	128	36	Boot	16	4	2	4	-	14	16	160	-	-	-	-	1	2	4	2	-	-	1.8	35	1	-	100	11.05
TMS320F2806	100	-	-	-	-	64	20	Boot	16	4	2	4	-	14	16	160	-	-	-	-	1	2	4	1	-	-	1.8	35	1	-	100	8.70
TMS320F2802	100	-	-	-	-	64	12	Boot	8	3	1	2	-	9	16	160	-	-	-	-	1	1	2	1	-	-	1.8	35	1	-	100	7.10
TMS320F2802-60	60	-	-	-	-	64	12	Boot	8	3	1	2	-	9	16	267	-	-	-	-	1	1	2	1	-	-	1.8	35	1	-	100	4.80
TMS320F2801	100	-	-	-	-	32	12	Boot	8	3	1	2	-	9	16	160	-	-	-	-	1	1	2	1	-	-	1.8	35	1	-	100	5.80
TMS320F2801-60	60	-	-	-	-	32	12	Boot	8	3	1	2	-	9	16	267	-	-	-	-	1	1	2	1	-	-	1.8	35	1	-	100	3.90
TMS320F28016	60	-	-	-	-	32	12	Boot	10	4	-	2	-	10	16	267	-	-	-	-	1	1	1	1	-	-	1.8	35	1	-	100	3.50
TMS320F28015	60	-	-	-	-	32	12	Boot	10	4	-	2	-	10	16	267	-	-	-	-	1	1	1	-	-	-	1.8	35	1	-	100	3.25

*Timers include CPU timers, PWM timers, eCAP timers and Watchdog timers

†Prices are quoted in U.S. dollars and represent 2012 suggested retail pricing for baseline packages and device configurations. All prices are subject to change.

Concerto™ Microcontrollers

Concerto MCUs bring together connectivity and control by combining an ARM® Cortex™-M3 core with C2000's C28x core and control peripherals in a single device. With Concerto, applications such as solar inverters and industrial control can retain the benefits of separate communications and control sub-systems while enjoying the benefits of a single-chip solution.

See why Concerto MCUs have changed the game for intelligent power electronics applications.

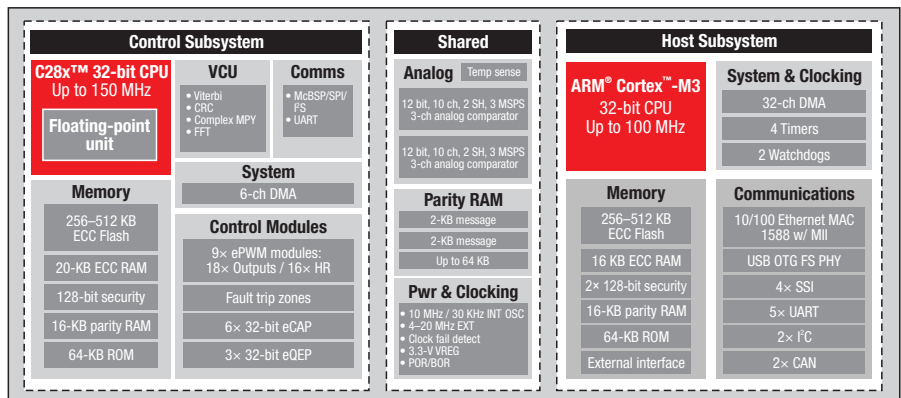

Starting at **U.S. \$6.71**
Q100 qualified and **125°C** temperature support

Control OR Communications: Why compromise? Get the best of both!

C2000 focused real-time control and ARM Cortex-M3 focused connectivity

Single MCU challenge



- Compromise between ideal host and control capability
- Complex tasking / prioritization
- Still appropriate for deeply embedded systems

Dedicated MCUs challenge



- Additional complexity
- Dual developments plus interface challenges / latency
- Necessary solution depending on isolation boundary trade-offs

Concerto solution

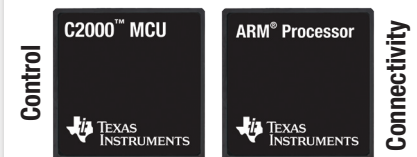

- Independent, optimized, subsystems on a single device
- Tightly coupled interface
- Single platform for development
- No compromises

C2000 + ARM® Cortex™-M3

Using two strengths to your advantage

C2000 MCUs:

Precision control

- Industry-leading computational performance
- VCU communications accelerator hardware
- C2000 high-resolution PWMs
- Lowest latency control loops
- Robust control software support
- High-speed precision analog
- Fine-tuned control architecture

ARM:

Ecosystem of developers

- Operating systems
- Middleware
- Software infrastructure

Robust communication

- Ethernet
- USB
- CAN
- Serial
- Wireless
- Fieldbus support

Thinking safety?

Certification made easy with Concerto safety-enabling features

Error detection and correction

- Memory with error correction (ECC)
- Cyclic redundancy checking (CRC)
- Comparators for over-voltage and over-current protection
- Parity on CAN and interrupt registers

Security

- Lock protection on GPIO and registers
- Memory protection for IP safeguarding
- Permanent JTAG disable for anti-theft



Redundancy

- Two cores for cross checking computations and peripheral results
- Two ADCs for reliable measurements
- Two clocks for backup
- Multiple system watchdogs

TMS320C2000™ Microcontrollers

Device	Processor				Memory			Control Interfaces										Communication Ports							External memory interface	Core supply (V)	GPIO pins	On-chip oscillator	Voltage regulator	Package pin counts	10 kU pricing (U.S. \$)*			
	Speed (MHz) C28x/M3	FPU	CLA co-processor	VCU accelerator	DMA	Flash (KB)	RAM (KB)	ROM (KB)	PWM ch.	High-resolution PWM ch.	Quadrature encoder	Event captures	HRCAP	Timers*	# of ADCs	12-bit ADC ch.	ADC conversion time (ns)	Comparators	OpAmp/PGA	USB	Ethernet	McBSP	IC	UART/SCI								SPI	CAN	LIN
Concerto™ MCU generation																																		
F28M35Ex MCUs Entry																																		
F28M35E20B	60/60	Yes	–	Yes	Yes	512	72	Boot	24	16	3	6	–	25	2	20	433/433	6	–	–	–	1	1	6	5	2	–	Yes	3.3	64	2	Yes	144	6.71
F28M35E20C	60/60	Yes	–	Yes	Yes	512	72	Boot	24	16	3	6	–	25	2	20	433/433	6	–	1	Yes	1	1	6	5	2	–	Yes	3.3	64	2	Yes	144	8.15
F28M35E22B	60/60	Yes	–	Yes	Yes	512	136	Boot	24	16	3	6	–	25	2	20	433/433	6	–	–	–	1	1	6	5	2	–	Yes	3.3	64	2	Yes	144	8.64
F28M35E22C	60/60	Yes	–	Yes	Yes	512	136	Boot	24	16	3	6	–	25	2	20	433/433	6	–	1	Yes	1	1	6	5	2	–	Yes	3.3	64	2	Yes	144	10.08
F28M35E32B	60/60	Yes	–	Yes	Yes	768	136	Boot	24	16	3	6	–	25	2	20	433/433	6	–	–	–	1	1	6	5	2	–	Yes	3.3	64	2	Yes	144	9.26
F28M35E32C	60/60	Yes	–	Yes	Yes	768	136	Boot	24	16	3	6	–	25	2	20	433/433	6	–	1	Yes	1	1	6	5	2	–	Yes	3.3	64	2	Yes	144	10.70
F28M35E50B	60/60	Yes	–	Yes	Yes	1024	72	Boot	24	16	3	6	–	25	2	20	433/433	6	–	–	–	1	1	6	5	2	–	Yes	3.3	64	2	Yes	144	8.88
F28M35E50C	60/60	Yes	–	Yes	Yes	1024	72	Boot	24	16	3	6	–	25	2	20	433/433	6	–	1	Yes	1	1	6	5	2	–	Yes	3.3	64	2	Yes	144	10.32
F28M35E52B	60/60	Yes	–	Yes	Yes	1024	136	Boot	24	16	3	6	–	25	2	20	433/433	6	–	–	–	1	1	6	5	2	–	Yes	3.3	64	2	Yes	144	9.64
F28M35E52C	60/60	Yes	–	Yes	Yes	1024	136	Boot	24	16	3	6	–	25	2	20	433/433	6	–	1	Yes	1	1	6	5	2	–	Yes	3.3	64	2	Yes	144	11.29
F28M35Mx MCUs Mid-End																																		
F28M35E20B	75/75	Yes	–	Yes	Yes	512	72	Boot	24	16	3	6	–	25	2	20	347/347	6	–	–	–	1	1	6	5	2	–	Yes	3.3	64	2	Yes	144	9.12
F28M35E20C	75/75	Yes	–	Yes	Yes	512	72	Boot	24	16	3	6	–	25	2	20	347/347	6	–	1	Yes	1	1	6	5	2	–	Yes	3.3	64	2	Yes	144	10.56
F28M35E22B	75/75	Yes	–	Yes	Yes	512	136	Boot	24	16	3	6	–	25	2	20	347/347	6	–	–	–	1	1	6	5	2	–	Yes	3.3	64	2	Yes	144	10.08
F28M35E22C	75/75	Yes	–	Yes	Yes	512	136	Boot	24	16	3	6	–	25	2	20	347/347	6	–	1	Yes	1	1	6	5	2	–	Yes	3.3	64	2	Yes	144	11.52
F28M35E32B	75/75	Yes	–	Yes	Yes	768	136	Boot	24	16	3	6	–	25	2	20	347/347	6	–	–	–	1	1	6	5	2	–	Yes	3.3	64	2	Yes	144	10.70
F28M35E32C	75/75	Yes	–	Yes	Yes	768	136	Boot	24	16	3	6	–	25	2	20	347/347	6	–	1	Yes	1	1	6	5	2	–	Yes	3.3	64	2	Yes	144	12.14
F28M35E50B	75/75	Yes	–	Yes	Yes	1024	72	Boot	24	16	3	6	–	25	2	20	347/347	6	–	–	–	1	1	6	5	2	–	Yes	3.3	64	2	Yes	144	10.32
F28M35E50C	75/75	Yes	–	Yes	Yes	1024	72	Boot	24	16	3	6	–	25	2	20	347/347	6	–	1	Yes	1	1	6	5	2	–	Yes	3.3	64	2	Yes	144	11.76
F28M35E52B	75/75	Yes	–	Yes	Yes	1024	136	Boot	24	16	3	6	–	25	2	20	347/347	6	–	–	–	1	1	6	5	2	–	Yes	3.3	64	2	Yes	144	11.28
F28M35E52C	75/75	Yes	–	Yes	Yes	1024	136	Boot	24	16	3	6	–	25	2	20	347/347	6	–	1	Yes	1	1	6	5	2	–	Yes	3.3	64	2	Yes	144	12.72
F28M35Hx High-End																																		
F28M35E20B	150/75 or 100/100	Yes	–	Yes	Yes	512	72	Boot	24	16	3	6	–	25	2	20	347/520	6	–	–	–	1	1	6	5	2	–	Yes	3.3	64	2	Yes	144	11.76
F28M35E20C	150/75 or 100/100	Yes	–	Yes	Yes	512	72	Boot	24	16	3	6	–	25	2	20	347/520	6	–	1	Yes	1	1	6	5	2	–	Yes	3.3	64	2	Yes	144	13.20
F28M35E22B	150/75 or 100/100	Yes	–	Yes	Yes	512	136	Boot	24	16	3	6	–	25	2	20	347/520	6	–	–	–	1	1	6	5	2	–	Yes	3.3	64	2	Yes	144	12.72
F28M35E22C	150/75 or 100/100	Yes	–	Yes	Yes	512	136	Boot	24	16	3	6	–	25	2	20	347/520	6	–	1	Yes	1	1	6	5	2	–	Yes	3.3	64	2	Yes	144	14.16
F28M35E32B	150/75 or 100/100	Yes	–	Yes	Yes	768	136	Boot	24	16	3	6	–	25	2	20	347/520	6	–	–	–	1	1	6	5	2	–	Yes	3.3	64	2	Yes	144	13.34
F28M35E32C	150/75 or 100/100	Yes	–	Yes	Yes	768	136	Boot	24	16	3	6	–	25	2	20	347/520	6	–	1	Yes	1	1	6	5	2	–	Yes	3.3	64	2	Yes	144	14.78
F28M35E50B	150/75 or 100/100	Yes	–	Yes	Yes	1024	72	Boot	24	16	3	6	–	25	2	20	347/520	6	–	–	–	1	1	6	5	2	–	Yes	3.3	64	2	Yes	144	12.96
F28M35E50C	150/75 or 100/100	Yes	–	Yes	Yes	1024	72	Boot	24	16	3	6	–	25	2	20	347/520	6	–	1	Yes	1	1	6	5	2	–	Yes	3.3	64	2	Yes	144	14.40
F28M35E52B	150/75 or 100/100	Yes	–	Yes	Yes	1024	136	Boot	24	16	3	6	–	25	2	20	347/520	6	–	–	–	1	1	6	5	2	–	Yes	3.3	64	2	Yes	144	13.92
F28M35E52C	150/75 or 100/100	Yes	–	Yes	Yes	1024	136	Boot	24	16	3	6	–	25	2	20	347/520	6	–	1	Yes	1	1	6	5	2	–	Yes	3.3	64	2	Yes	144	15.36

*Timers include CPU timers, PWM timers, eCAP timers and Watchdog timers

†Prices are quoted in U.S. dollars and represent 2012 suggested retail pricing for baseline packages and device configurations. All prices are subject to change.

C2000 Software Solutions

controlSUITE™ Software Suite

controlSUITE software is a completely free suite of device software, development kit resources, software libraries, documentation, and design support. controlSUITE software comes with a graphical user interface (GUI) for easy visual navigation of all C2000 design resources. Users can learn through device-level example projects, begin application development with development kits, understand control methods through detailed application guides, and explore everything C2000 MCUs have to offer. With controlSUITE software, it is easy to access all the resources you need to for development. No more scouring the web searching for device headers, libraries, or documentation, controlSUITE software is a centralized resource for all C2000 microcontroller software, hardware and technical resource needs.

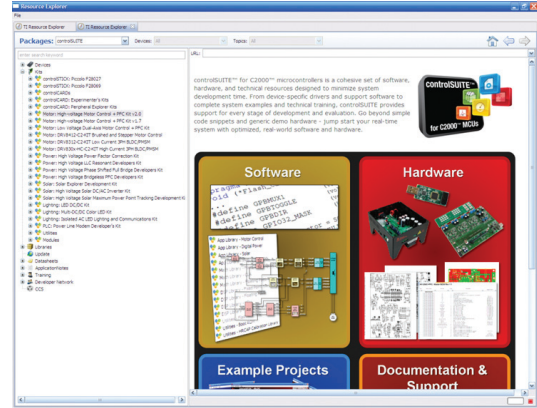

Learn more and download today at www.ti.com/controlSUITE

All of your design resources in one place!

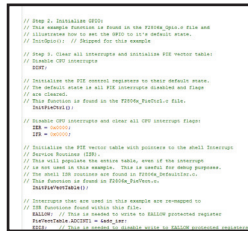

Example projects

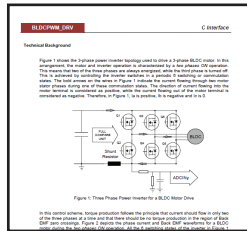

Device and application libraries

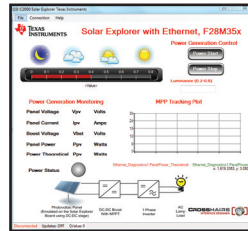

Kit software and GUIs

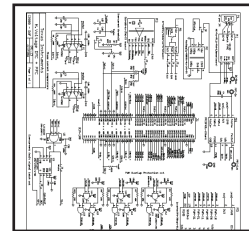

Hardware design files

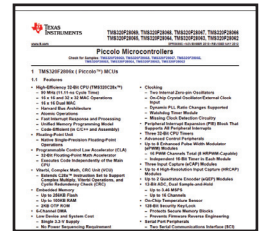

Datasheets, users guides, and more

Code Composer Studio™ IDE

Code Composer Studio (CCStudio) integrated development environment (IDE) comprises a single-user interface to a suite of tools used to develop and debug TI embedded applications.

Code Composer Studio IDE features

- C2000-optimized compilers
- Source code editor
- Project build environment
- Debugger (Full C/C++ and Assembly debugging)
- Profiler
- Simulators
- Real-time operating system
- Intuitive Eclipse-based interface

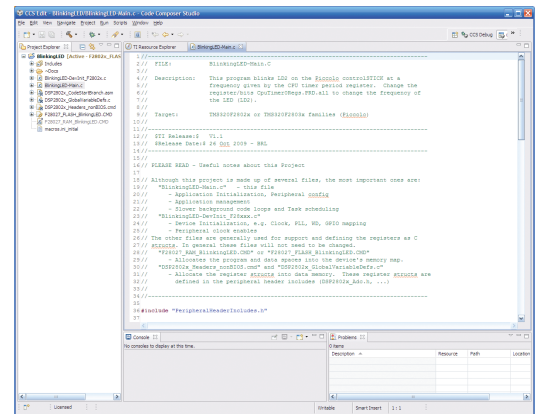

Learn more and download today at www.ti.com/ccs

C2000 MCUs real-time debugging

- Graph and modify variables/registers in real-time while running code
- Allows you to halt non-critical code for debugging while time-critical interrupts continue to be serviced
- Access memory and registers without stopping the processor
- Implemented in silicon, not by a debugging monitor: easy to use, no application resources required

controlSUITE™ Device Libraries

We have reinvented the wheel so you do not have to!



IQMath™ Library – A Virtual Floating-Point Engine

Texas Instruments IQMath Library is a virtual floating-point engine. This library is a collection of highly optimized mathematical functions enabling C/C++ programmers to develop with floating-point math on devices without native floating-point hardware support. IQMath enables code to be seamlessly ported between floating- and fixed-point devices for ultimate code scalability. The IQMath functions facilitate execution speeds considerably faster than equivalent code written in ANSI C on fixed-point MCUs, while eliminating the burden of dealing with fixed-point scaling. Just write C floating-point code and let the compiler take care of the rest.



DSP Fixed- and Floating-Point Libraries

Offers support for common DSP operations such as complex FFTs, real FFTs, inverse FFTs, FIR filters, IIR filters, vector and matrix routines, common math routines and utility functions.



DSP Signal Generation Library

Makes signal waveform generation easy with SIN generation, ramp generation and trapezoidal generation modules.



VCU DSP Library – Accelerated FFTs, Viterbi Decoding and CRC Memory Checking

VCU hardware accelerator library containing library functions for real, complex and inverse FFTs, Viterbi Add-Compare-Select and traceback operation, and CRC memory checking up to 32 bits. With the combination of the VCU hardware accelerator and library support, developers can achieve 2-cycle Viterbi butterfly operation, 3-cycle Viterbi traceback operation, 5-cycle 16-bit FFT butterfly operation, and overall, accelerate communications algorithms by up to 8× over the main C28x core of C2000™ devices.



Math Libraries

Common trigonometric and math function support. Includes libraries for fixed-point devices, floating-point devices and the CLA co-processor.

controlSUITE Software Application Libraries

Modular, application-tuned libraries essential for real-time control systems



Motor Control Library

Consists of C macros covering nearly all target-independent mathematical functions and target-specific peripheral configuration functions essential for motor control. This includes transformation and observer modules, signal generators and control modules, peripheral drivers and real-time debugging modules.



Digital Power Library

Consists of modules that enable digital control of various power topologies. This includes peripheral drivers, control modules, mathematical functions and utility functions.



Solar Power Library

Provides a framework of common solar algorithms to ease implementation of solar systems. This includes Maximum Power Point Tracking (MPPT) algorithms, Phase Locked Loop (PLL) modules, control modules and math modules.



Power Line Communications Libraries

Texas Instruments is a leader in Power Line Communications (PLC) technology, providing software for various modulations and standards. Included software libraries ease development of PLC applications for SFSK IEC61334, PRIME and G3 standards. FlexOFDM libraries are also available for custom OFDM implementations, enabling scalability for the emerging standards.

Digital Power

C2000 microcontrollers bring a new range of possibilities in digital power management and power control. A digitally controlled system based on a C2000 MCU overcomes many of the analog power supply challenges and provides significant benefits to most power supplies, such as improved efficiency, added functions and features, and increased reliability. For example, C2000 microcontroller-driven power supplies are reaching unprecedented efficiency levels, especially at light loads. TI provides digital power algorithms and user-friendly software libraries that can be adapted to different topologies and voltage power levels, allowing for faster time to market. www.ti.com/digitalpower

controlSUITE™ software includes multiple control methods and multiple topologies through modular software for C2000 microcontrollers at no cost. www.ti.com/controlsuite

Why go for digital power?

Reduces costs

- Tunable platforms lead to new products quicker
- Calibration, better noise and temperature immunity
- Reduced board area and parts count

Higher reliability

- Built-in supervision
- Intelligent diagnostics, failure prediction, reporting capability

Higher quality

- Adaptive efficiency across load range
- Flexibility through programmability
- Calibration at final functional test
- Less sensitive to drift and better noise immunity
- Parameter monitoring for continual quality improvement
- Proven concept in mature digital motor control market

Key Applications

- Switch-mode power supplies
- Uninterruptible power supplies
- AC/DC rectifiers
- Hybrid vehicles
- Digital TVs
- DC-DC modules or POLs:
 - Buck or boost
 - Half-bridge
 - Full-bridge
 - Multiphase interleaved
- Communication systems in:
 - Server farms
 - Base stations
 - Telecom/Consumer equipments

Tools and software for digital power applications

High voltage development kits and digital power software libraries to jump start designs

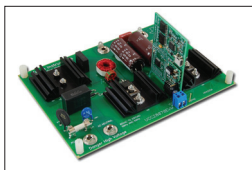

Power Factor Correction Kit – \$249

- 2-phase interleaved PFC
- 300W, up to 400V DC output
- Isolated JTAG for real-time debug
- Comes with Piccolo™ F28027 controller card

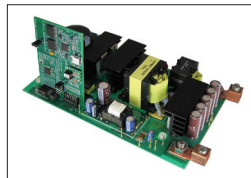

Phase Shifted Full Bridge – \$550

- Up to 400VDC input
- 600W 12VDC output
- Supports peak current mode with slope compensation on chip
- Comes with Piccolo F28027 controller card

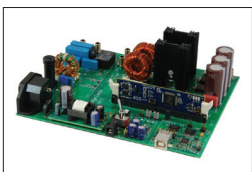

Bridgeless PFC Kit – \$450

- 2-phase interleaved PFC
- 300W, up to 400V DC output
- Isolated JTAG for real-time debug
- Comes with Piccolo F28035 controller card

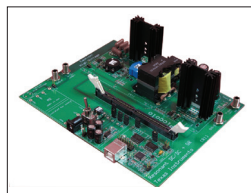

Resonant LLC Kit – \$400

- Up to 400VDC input
- 360W 12VDC output
- Experiment with OCP, OVP and UVP
- Comes with Piccolo F28027 controller card

Digital Motor Control

Texas Instruments understands the challenges facing motor-control developers, and provides software and tools that significantly accelerate development of motor-control systems. Thorough documentation, rich suites of digital motor control and math libraries, modular software strategies, and open-source motor-control development kits lead developers through the process of creating a complete motor-control system. Combining this complete motor ecosystem with motor-tuned microcontroller architectures, C2000 MCUs reduce the overall cost of motor-control systems and enable control techniques to create efficient, cutting edge solutions. www.ti.com/c2000dmc

Key Applications

- Variable-speed drives
- Servo drives
- Appliance motors
- HVAC compressors and blowers
- Industrial pumps
- Electric power steering
- Soft starters
- White goods

C2000 motor control gives you MORE

- Variable speed control → MORE efficient motors
- Field-oriented control → MORE efficient control
- Space vector PWM → MORE efficient power stage
- Sensor-less control → MORE cost effective
- Multi-axis control → MORE motors per controller
- Integrated digital PFC → MORE system functions
- Meeting IEC standards → MORE reliable and robust
- Broadest MCU portfolio → MORE products, one platform

Brushed & Stepper Motor Kit with DRV8412 & Piccolo MCU – \$199

- 52V, 3.5A 3-phase motor driver stage
- Quadrature encoder interface
- Piccolo F28035 microcontroller control
- Includes two brushed DC and one stepper motor



High-Voltage PFC and MC Developer's Kit – \$599

- 1.5KW, 350V 3-phase motor driver stage
- 750W 110–220 VAC PFC stage
- CAN control ACI, PMSM and BLDC
- Motors of each type available directly from TI (sold separately)
- Isolated CAN and UART interfaces



Three-Phase BLDC & PMSM Motor Kit with DRV8301/DRV8302 and Piccolo MCU – \$299

- 60V, 60A 3-phase motor driver stage
- NO motor included
- Spin your own motor instantly with InstaSPIN™-BLDC software
- Hall & Quadrature encoder interfaces
- Isolated SPI and CAN interfaces



Three Phase BLDC & PMSM Motor Kit with DRV8312 & Piccolo MCU – \$299

- 50V, 3.5A 3-phase motor driver stage
- NEMA17 BLDC/PMSM 55W motor
- Spin your own motor instantly with InstaSPIN-BLDC software
- Hall & Quadrature encoder interfaces
- Isolated SPI and CAN interfaces



Automotive

The automotive industry is constantly looking for new ways to make their cars safer, more reliable, and more efficient. The powerful PWM modules and analog ADC integrated in C2000 microcontroller devices can be used in applications such as collision avoidance, power steering, radar applications, heads-up display and electronically-controlled interfaces.

The industry is also looking at a shift toward hybrid and fully electric vehicles, and C2000 MCUs provide a low-cost solution to many aspects of HEV/EV operation. With a powerful DSP-based core, a variety of communication protocols including LIN and CAN, and automotive AEC-Q100 qualification (–40° to 125°C), C2000 microcontrollers work to complete your automotive designs. www.ti.com/hev

HEV benefits

Reconfigurable constant voltage/current/power charging mode

Optimized battery charging to extend battery life and performance

Communication via PLC for smart charging

Improved SOC/SOH estimation for optimal battery usage



Key Applications

- Automotive radar and collision avoidance
- Electric power steering
- Drive-by-wire
- Power conversion
- Heads-up displays
- Hybrid Electric Vehicle/Electric Vehicle (HEV/EV)
 - Off-line battery charger
 - DC/DC power conversion
 - Battery management system
 - Electric motor inverter

Tools and Software

- Hardware reference designs
 - Start/Stop system – 4-phase interleaved boost
 - Motor control board for small task-oriented vehicles (STOV)
 - Automotive headlamp
- controlSUITE™ software

Power-Line Communications

Power-line communications (PLC) transmit data over an existing high-voltage power line instead of requiring dedicated cabling. Although the technology has been used for decades, recent concepts and ideas have opened the door to new innovations driven by power line communication. C2000 microcontrollers are an ideal platform for power-line networked applications because the performance, large on-chip memory, and integrated peripheral interfaces provide a single-chip solution for control and PLC functions. Additionally, with unique on-chip IP such as the Verterbi Complex Math Unit (VCU), C2000 MCUs are tuned for power-line communications, offering unparalleled performance in a cost-sensitive package. TI has developed freely available PLC software libraries and hardware reference designs which provide a flexible platform to quickly develop and test robust PLC implementations. With a flexible PLC development platform and PLC-optimized C2000 MCUs, TI provides industry-leading solutions for PLC development. www.ti.com/plc

Key Applications

- Lighting
- Solar
- Metering
- Industrial controls
- Ballast
- Security gates/cameras
- Motor control

C2000 Power-Line Modem Developer's Kit – \$599

- Two PLC modems
- PLC software supporting OFDM (PRIME, G3, FlexOFDM) and SFSK communication
- Two F28069 controlCARDs included



Benefits

Single C2000 MCU has the performance and peripherals to control the entire system

PLC systems controlled with software allow multiple standard support and easy protocol updating

Software-based system allows modulation scheme to be changed in software

Integrated system communication interfaces: I²C, CAN, SPI, UART, LIN

Precision Sensing and Control

The growing requirements to add active intelligence and functionality to sensing and measurement applications make microcontrollers that enable a high-precision response very desirable. The benefits of a DSP-based core (filtering and high-performance calculations) combined with the best features of an MCU (easy development and low-cost integration) allow for innovative implementations and advancements of common systems. The C2000 platform is composed of components that can improve almost any application that requires precision sensing and control.

Key Applications

- RFID readers
- Musical effects
- Alarm systems
- Robots
- Motor systems
- Medical
- Bar-code scanners
- Pressure/torque/inertial sensors
- Capacitive/piezoresistive sensors
- Thermal and laser control for optical networks
- Radar sensing

Tools and Software

- C2000 LaunchPad
- Experimenter's Kit
- Peripheral Explorer Kit
- Software libraries

Peripheral Explorer Kit – \$179

- Easily learn how to use all of the advanced peripherals on a C2000 MCU
- Ready-to-run software and hardware
- Comes with an F28335 controlCARD
- Includes on-board USB JTAG emulation
- Includes C2000 teaching CD-ROM

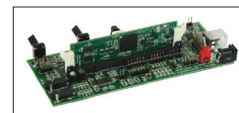

Benefits

Accurate measurements

- Fastest on-chip ADC on the market – up to 12.5 MSPS with dual sample-and-hold to allow concurrent measurements

Precise outputs and control

- Multiple high-resolution PWM modules provide step resolution at 55ps
- Fully configurable PWM outputs allow the creation of almost any output waveform with any synchronization scheme
- 32-bit enhanced captures with four event time stamps

Minimize cost and improve reliability

- Dual integrated high-speed oscillators and analog comparators
- Power-on reset, brown-out protection, and programmable trip conditions

Solar Energy

Solar energy is a booming technology for energy harvesting. With C2000 microcontrollers, solar systems can extract more energy from the sun through advanced power conversion and maximum power point tracking (MPPT) performance. Whether the system feeds power back to the grid, charges a battery, or both, C2000 MCUs provide the power conversion control to most efficiently extract and deliver energy.

Solar Explorer Development Kit – \$349

- 20VDC / 50W non-isolated design
- Single-switch DC/DC boost for MPPT
- DC/DC sepic for MPPT and battery charging
- Output inverter stage 24VAC maximum
- Piccolo™ MCU

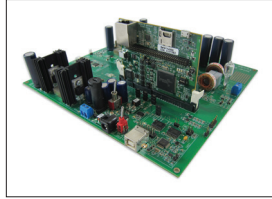

High-Voltage Solar DC/DC MPPT Kit – \$349

- 200–300VDC input up to 500W
- 400VDC output
- 2-phase DC/DC boost for MPPT
- 1:1 resonant LLC for isolation
- Piccolo MCU



High Voltage Solar 1-Phase Inverter Kit – \$349

- >96% efficient
- Grid-tie with enable/disable
- Ethernet remote control and monitoring
- 110/220VAC selectable output
- Piccolo or Concerto™ MCU control

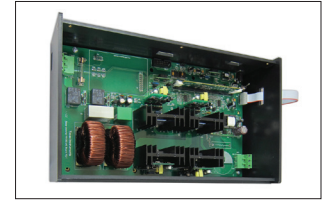

Key Applications

- Central and string inverters
- Micro inverters
- On- and off-grid solar applications
- Battery charging applications
- Solar arc detection

Lighting

LED lighting is increasingly becoming the dominant lighting technology due to its inherent efficiency, safety, configurability, and aesthetic benefits. Likewise, C2000 microcontrollers are an ideal solution for many LED lighting applications. With an optimized DSP core and powerful peripherals, C2000 microcontrollers provide the processing capability and integration to drive low-cost, dynamic, and energy-efficient lighting systems. With just a single, low-cost Piccolo™ MCU, high efficiency digital power conversion, dynamic multi-string LED lighting control, and advanced communications can be implemented in a lighting system. www.ti.com/led

Key Applications

- Industrial & commercial lighting
- Building lighting
- Street lighting
- Stage lighting
- Automotive lighting
- Large infrastructure lighting
- Intelligent lighting

DC/DC LED Lighting Developer's Kit – \$399

- Eight independent 10-watt LED driver stages
- Buck or boost DC/DC power stage
- Digital control of DC/DC power stage and LED driver stages with a single Piccolo MCU
- Includes Piccolo F28035 controlCARD

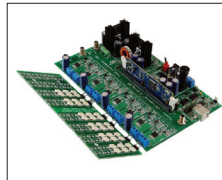

Multi-DC/DC Color LED Kit – \$499

- Eight independent DC/DC boost/sepic power stages
- Implements color mixing
- Digital control of eight DC/DC power stages and eight LED driver stages with a single Piccolo MCU
- Includes Piccolo F28027 controlCARD

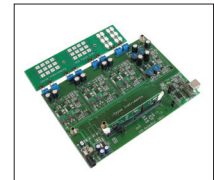

Benefits

Increase operating efficiency across lighting conditions

Single design for multiple lighting fixture implementations

Add intelligence with advanced communications protocols such as Power-Line Communications (PLC), DALI, DMX, KNX, etc.

Precise LED intensity, dimming, and color mixing through on-chip high-resolution PWM and ADC peripherals

Reduce cost through integration of all major control systems into a single MCU

Easy field upgrades and dynamic on-the-fly adjustments

Easy implementation of advanced features such as temperature sensing and correction, dimming scheduler, aging compensation, etc.

Isolated AC LED Lighting & Communications Kit – \$699

- AC/DC LED lighting power supply
- 6 LED strings with dimming
- DALI, DMX512, & Power Line Communications (PLC)

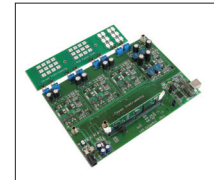

C2000™ Microcontrollers

C2000 LaunchPad – A new robust platform to get started with C2000 MCUs

Get started in minutes

- Integrated USB-powered (cable included) isolated JTAG emulation tool protects host PC
- No additional hardware or soldering needed

Rapid prototyping

- Allows interface to external components or custom daughter boards
- Access to all C2000 pins with pin mappings*
- One programmable push button, one push button for CPU reset and four LEDs

*Except JTAG

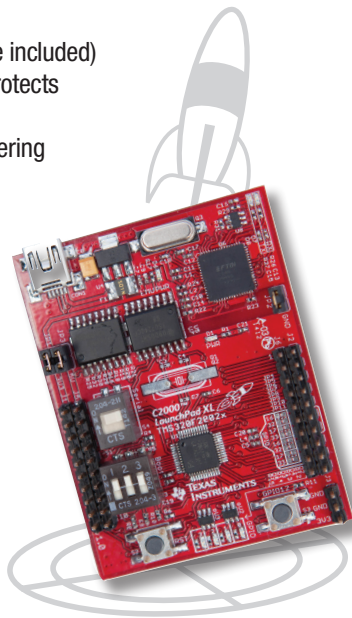

Just \$17

Easily evaluate and program

- 40 PCB pins (double-sided male connectors), accessible from top and bottom
- C2000 Piccolo™ TMS320F28027 MCU includes a 12-bit ADC, temperature sensor, timers, UART, SPI, I²C, high-resolution PWMs and comes pre-programmed with a temperature measurement demo application

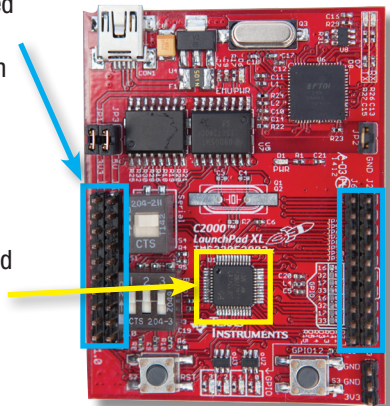

LED BoosterPack – Leading a growing ecosystem of BoosterPacks for the C2000 LaunchPad

Easily plug in C2000 LaunchPad to add lighting capability

Interface to the MSP430™ Capacitive Touch BoosterPack to enable touch-controlled LED lighting

3 boost converters to drive LEDs and allow control of dimming and color management

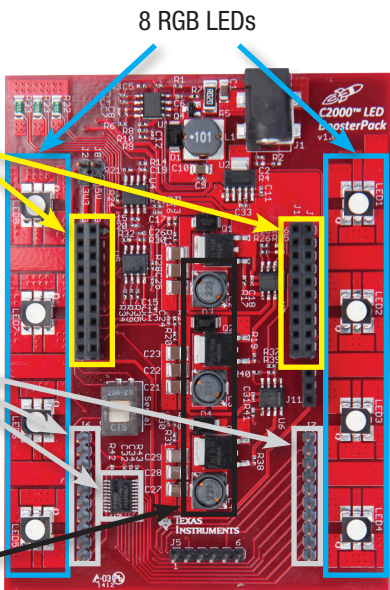

Just \$30

Create unique solutions with modular BoosterPack Ecosystem:

C2000 LaunchPad
+
LED BoosterPack
+
MSP430 Capacitive Touch BoosterPack
=
Capacitive Touch LED Lighting Control

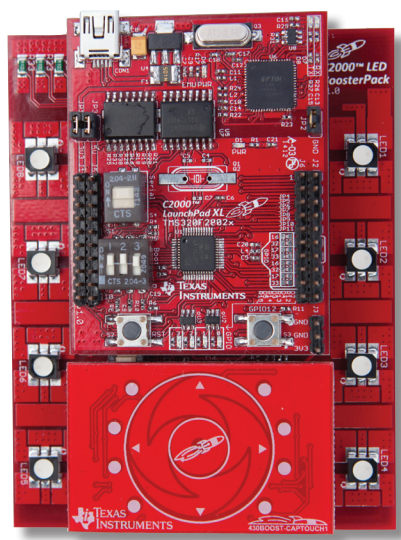

controlCARD ecosystem

We understand picking the right processor can be tough, and purchasing device-specific EVM boards can become costly. That's why we created the controlCARD development platform.

C2000 controlCARDs detach the C2000 processor and all necessary support circuitry from development boards, and instead, assemble these onto modular adapter cards, called "controlCARDs". With the C2000 controlCARD platform, a designer can evaluate multiple C2000 MCUs using the same development board. Simply unplug the old controlCARD and plug-in a new controlCARD. By separating the MCU and support circuitry from the development board, controlCARDs simplify hardware prototyping and reduce replacement costs.

With over 20 device and end-equipment development kits available, C2000 MCUs make it easy to start developing today. All kits are complete with the Code Composer Studio™ IDE and on-board USB JTAG support. Provided through C2000 MCUs' controlSUITE Software Suite, each kit also includes fully documented software, example code and hardware development packages. Visit www.ti.com/c2000tools for a complete listing of C2000 development tools, and visit www.ti.com/controlSUITE to download controlSUITE software for C2000 development kits.



controlCARDs				
Part number	MCU	Socket	Incl. USB JTAG	Price (Each, U.S. \$)
TMDSNCND28044	TMS320F28044	DIMM100	–	59
TMDSNCND2808	TMS320F2808	DIMM100	–	59
Piccolo™ MCUs				
TMDSNCND28027	TMS320F28027	DIMM100	–	49
TMDSNCND28035	TMS320F28035	DIMM100	–	59
TMDSNCND28035ISO	TMS320F28035	DIMM100	Yes	69
TMDSNCND28069	TMS320F28069	DIMM100	–	59
TMDSNCND28069ISO	TMS320F28069	DIMM100	Yes	85
Delfino™ MCUs				
TMDSNCND28335	TMS320F28335	DIMM100	–	69
TMDSNCND28346-168	TMS320C28346	DIMM168	–	125
Concerto™ MCUs				
TMDSNCNDH52C1	F27M35H52C1	DIMM100	Yes	130

Experimenter's Kit

C2000 Experimenter's Kits are great tools for device exploration and initial prototyping. Each Experimenter's Kit includes a docking station and controlCARD with a C2000 MCU. The docking station provides access to all controlCARD signals and includes an on-board USB JTAG emulator. For prototyping, there are two breadboard areas and header pins, allowing for creation of custom solutions.

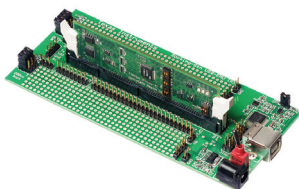

Experimenter's Kits				
Part number	MCU	Socket	Incl. USB JTAG	Price (Each, U.S. \$)
TMDSDOCK2808	TMS320F2808	DIMM100	Yes	89
Piccolo MCUs				
TMDSDOCK28027	TMS320F28027	DIMM100	Yes	79
TMDSDOCK28035	TMS320F28035	DIMM100	Yes	130
TMDSDOCK28069	TMS320F28069	DIMM100	Yes	99
Delfino MCUs				
TMDSDOCK28335	TMS320F28335	DIMM100	Yes	99
TMDSDOCK28346-168	TMS320C28346	DIMM168	Yes	125
Concerto MCUs				
TMDSDOCKH52C1	F27M35H52C1	DIMM100	Yes	185

Peripheral Explorer Kit

The C2000 Peripheral Explorer Kit is a great learning tool for new C2000 developers and university students. The kit includes a peripheral explorer board and a controlCARD with the TMS320F28335 MCU. The board includes many hardware-based peripheral components for interacting with the various peripherals common to C2000 MCUs, such as the ADC, PWMs, eCAP, I²C, CAN, SPI and McBSP. Likewise, a teaching ROM is provided containing presentation slides, a learning textbook with over 750 pages, and over 15 laboratory exercises with solutions.

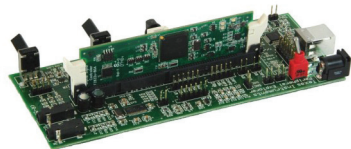

Peripheral Explorer Kit				
Part number	MCU	Socket	Incl. USB JTAG	Price (Each, U.S. \$)
Delfino™ MCUs				
TMDSPREX28335	TMS320F28335	DIMM100	Yes	179

controlSTICK

C2000 controlSTICKs provide a low-cost way to experiment with C2000 MCUs. Starting at only U.S. \$39, these tools provide convenient cableless USB JTAG access. controlSTICKs provide access to all control peripherals through on-board headers. A suite of example projects guide users through the advanced functionality of Piccolo MCUs from simple blinking LEDs to configuration examples for the high-resolution PWM peripherals. controlSTICKs are a great starting point for development with C2000 MCUs.



controlSTICKs			
Part number	MCU	Incl. USB JTAG	Price (Each, U.S. \$)
Piccolo™ MCUs			
TMDS28027USB	TMS320F28027	Yes	39
TMDS28069USB	TMS320F28069	Yes	39

JTAG Emulators

Most C2000 development kits include on-board XDS100 emulation. However, for other JTAG needs, there are a wealth of third-party JTAG emulators available for C2000 MCUs:

JTAG emulators				
Third party	Emulator	Website	Part number	Price (Each, U.S. \$)
Spectrum Digital	XDS100	www.spectrumdigital.com	TMDSEMU100U-14T	79
Blackhawk	USB2000	www.blackhawk-dsp.com	TMDSEMU2000U	299
Spectrum Digital	XDS510C	www.spectrumdigital.com	See third-party website	249
Spectrum Digital	XDS510USB	www.spectrumdigital.com	See third-party website	1,299
Signum Systems	JTAGjet-C2000	www.signum.com	See third-party website	595
Signum Systems	JTAGjet-C2000-ISO	www.signum.com	JTAGjet-C2000-ISO	795
Signum Systems	JTAGjet-C2000F-ISO	www.signum.com	JTAGjet-C2000F-ISO	995

Development Kit Software

All software and hardware packages for development kits are included in the controlSUITE software suite. Visit www.ti.com/controlSUITE to download today.

Training

To better enable designers and engineers to make use of this performance, TI provides a multitude of training opportunities for C2000 microcontrollers. Between hands-on multi-day and one-day workshops and online training, it's easy to gain a working understanding of how to optimally use the C28x microcontroller and accelerate product development. Advanced technical seminars and deep-dive application training take these concepts still further. For a full list of training opportunities, visit www.ti.com/c2000training

Third-Party Tools and Software

The MathWorks® Embedded

Target for C2000 Microcontrollers

Embedded Target integrates MATLAB® and Simulink® with TI's Code Composer Studio™ IDE and C2000 microcontrollers. Together, these products let you perform automatic code generation, prototyping, and embedded system deployment. With Embedded Target, you can develop and validate control designs and DSP algorithms from concept through code.

www.mathworks.com/products/tic2000

Key Features

- Generates documented, readable, and editable C code in Code Composer Studio IDE project format
- Automates the testing and execution of Simulink models
- Enables the real-time evaluation of system designs on eZdsp™ boards
- Provides block-level access to on-chip peripherals
- Provides block-level access to the TI IQMath library for simulation and code generation

VisSim/Embedded Controls Developer™

VisSim/Embedded Controls Developer is a visual development environment for the rapid prototyping and development of motion-control systems.

VisSim is unique in its ability to generate small memory footprint target files and can drastically reduce development time and lower prototyping costs. www.vissim.com/c2000

Key Features

- VisSim/Motion per vissim.com block set that includes pre-built motor, amplifier, sensor, encoder, dynamic load, and PID models
- C2000 MCU DMC block set includes all of the TI DMC library in block form
- Peripheral blocks generate code for C2000 MCU on-chip devices
- Automatic C code generation of production-quality fixed-point code
- Real-time visualization while code executes on DSPs
- Code Composer Studio IDE plug-in for automatic project creation

Third Party	Website	Service
C2000 Microcontroller Third Parties		
D3 Engineering	www.d3engineering.com	Design Services; Consulting; Algorithms
Drivetech	www.drivetechinc.com	Design Services; Consulting; DMC Expertise
The MathWorks	www.mathworks.com	Embedded Target; Auto Code Generation
Visual Solutions	www.vissim.com	Rapid Prototyper; Visual Application Development
Signum Systems	www.signum.com	Tools: Flash Programming; Emulation
Windmill	www.windmill-systems.com	TCP/IP
Pentad Design	www.pentaddesign.com	Design Services, DPS and CLA Expertise
Codeskin	www.codeskin.com	Flash Programming Tools and C2000 Code Development
Simma Software	www.simmasoftware.com	CAN and LIN Development
Wittenstein	www.safertos.com	Safety-Certified Operating Systems for Concerto™ MCUs

Visit the TI E2E™ Community

Join fellow engineers at the TI E2E Community web site, where you can find training videos, blogs, and an active forum to find the answers to your questions. With a rapidly growing user base, the E2E community will serve as a nexus for all things TI. www.ti.com/c2000community

Videos – Watch videos on training, engineering topics, and TI events. Visit the E2E Videos section to learn not only about TI products but also new technologies and trends.

Blogs – Read blog posts about everything from new discoveries to rising cases of “net lag.” Find blogs with the musings of some of the brightest minds at TI.

Forums – Get help at the TI E2E forums. Perused by engineers both inside and outside TI, there's someone out there who understands your problems. And if you're feeling smart, don't hesitate to return the favor.

For all C2000 device configurations, please visit www.ti.com/c2000

Selected Package Options for TMS320C2000™ Devices

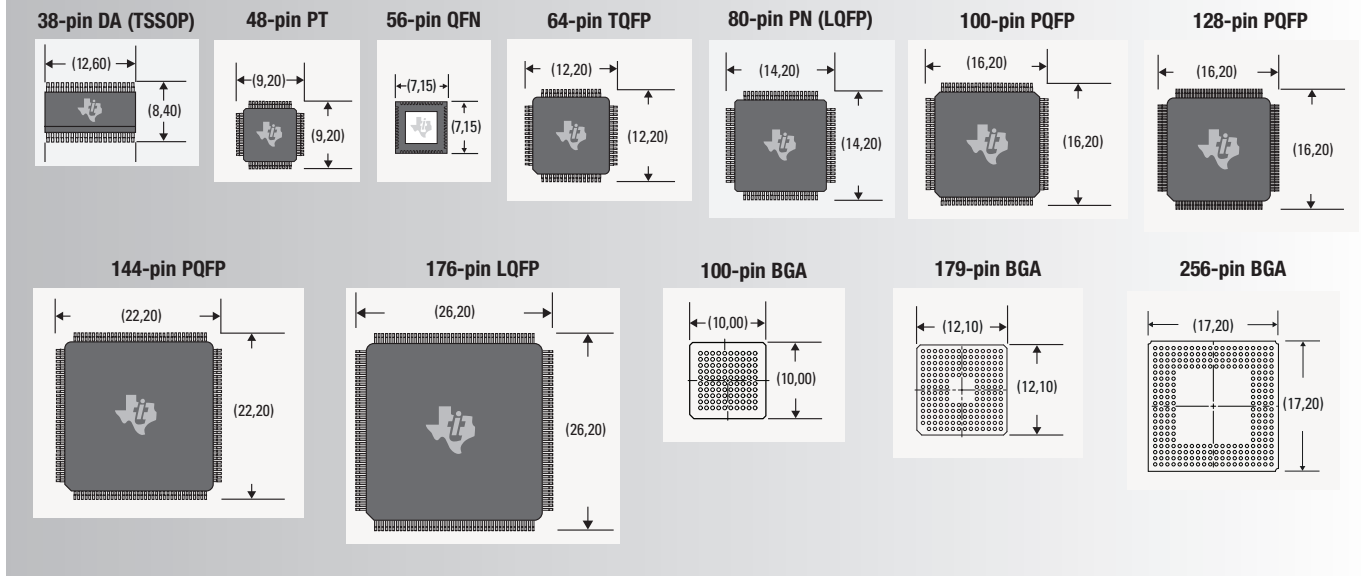

TI Worldwide Technical Support

Internet

TI Semiconductor Product Information Center Home Page
support.ti.com

TI E2E™ Community Home Page
e2e.ti.com

Product Information Centers

Americas	Phone	+1(972) 644-5580
Brazil	Phone	0800-891-2616
Mexico	Phone	0800-670-7544
	Fax	+1(972) 927-6377
	Internet/Email	support.ti.com/sc/pic/americas.htm

Europe, Middle East, and Africa

Phone		
European Free Call	00800-ASK-TEXAS (00800 275 83927)	
International	+49 (0) 8161 80 2121	
Russian Support	+7 (4) 95 98 10 701	
Note: The European Free Call (Toll Free) number is not active in all countries. If you have technical difficulty calling the free call number, please use the international number above.		
Fax	+ (49) (0) 8161 80 2045	
Internet	support.ti.com/sc/pic/euro.htm	
Direct Email	asktexas@ti.com	

Japan

Phone	Domestic	0120-92-3326
Fax	International	+81-3-3344-5317
	Domestic	0120-81-0036
Internet/Email	International	support.ti.com/sc/pic/japan.htm
	Domestic	www.tij.co.jp/pic

Asia

Phone		
International	+91-80-41381665	
Domestic	Toll-Free Number	
Note: Toll-free numbers do not support mobile and IP phones.		
Australia	1-800-999-084	
China	800-820-8682	
Hong Kong	800-96-5941	
India	1-800-425-7888	
Indonesia	001-803-8861-1006	
Korea	080-551-2804	
Malaysia	1-800-80-3973	
New Zealand	0800-446-934	
Philippines	1-800-765-7404	
Singapore	800-886-1028	
Taiwan	0800-006800	
Thailand	001-800-886-0010	
Fax	+8621-23073686	
Email	tiasia@ti.com or ti-china@ti.com	
Internet	support.ti.com/sc/pic/asia.htm	

Important Notice: The products and services of Texas Instruments Incorporated and its subsidiaries described herein are sold subject to TI's standard terms and conditions of sale. Customers are advised to obtain the most current and complete information about TI products and services before placing orders. TI assumes no liability for applications assistance, customer's applications or product designs, software performance, or infringement of patents. The publication of information regarding any other company's products or services does not constitute TI's approval, warranty or endorsement thereof.

B122010

The platform bar, C2000, C28x, Code Composer Studio, Concerto, controlSUITE, Delfino, DSP/BIOS, E2E, Piccolo, TMS320C2000, TMS320C28x and XDS510 are trademarks of Texas Instruments.

All other trademarks are the property of their respective owners.

IMPORTANT NOTICE

Texas Instruments Incorporated and its subsidiaries (TI) reserve the right to make corrections, enhancements, improvements and other changes to its semiconductor products and services per JESD46, latest issue, and to discontinue any product or service per JESD48, latest issue. Buyers should obtain the latest relevant information before placing orders and should verify that such information is current and complete. All semiconductor products (also referred to herein as "components") are sold subject to TI's terms and conditions of sale supplied at the time of order acknowledgment.

TI warrants performance of its components to the specifications applicable at the time of sale, in accordance with the warranty in TI's terms and conditions of sale of semiconductor products. Testing and other quality control techniques are used to the extent TI deems necessary to support this warranty. Except where mandated by applicable law, testing of all parameters of each component is not necessarily performed.

TI assumes no liability for applications assistance or the design of Buyers' products. Buyers are responsible for their products and applications using TI components. To minimize the risks associated with Buyers' products and applications, Buyers should provide adequate design and operating safeguards.

TI does not warrant or represent that any license, either express or implied, is granted under any patent right, copyright, mask work right, or other intellectual property right relating to any combination, machine, or process in which TI components or services are used. Information published by TI regarding third-party products or services does not constitute a license to use such products or services or a warranty or endorsement thereof. Use of such information may require a license from a third party under the patents or other intellectual property of the third party, or a license from TI under the patents or other intellectual property of TI.

Reproduction of significant portions of TI information in TI data books or data sheets is permissible only if reproduction is without alteration and is accompanied by all associated warranties, conditions, limitations, and notices. TI is not responsible or liable for such altered documentation. Information of third parties may be subject to additional restrictions.

Resale of TI components or services with statements different from or beyond the parameters stated by TI for that component or service voids all express and any implied warranties for the associated TI component or service and is an unfair and deceptive business practice. TI is not responsible or liable for any such statements.

Buyer acknowledges and agrees that it is solely responsible for compliance with all legal, regulatory and safety-related requirements concerning its products, and any use of TI components in its applications, notwithstanding any applications-related information or support that may be provided by TI. Buyer represents and agrees that it has all the necessary expertise to create and implement safeguards which anticipate dangerous consequences of failures, monitor failures and their consequences, lessen the likelihood of failures that might cause harm and take appropriate remedial actions. Buyer will fully indemnify TI and its representatives against any damages arising out of the use of any TI components in safety-critical applications.

In some cases, TI components may be promoted specifically to facilitate safety-related applications. With such components, TI's goal is to help enable customers to design and create their own end-product solutions that meet applicable functional safety standards and requirements. Nonetheless, such components are subject to these terms.

No TI components are authorized for use in FDA Class III (or similar life-critical medical equipment) unless authorized officers of the parties have executed a special agreement specifically governing such use.

Only those TI components which TI has specifically designated as military grade or "enhanced plastic" are designed and intended for use in military/aerospace applications or environments. Buyer acknowledges and agrees that any military or aerospace use of TI components which have **not** been so designated is solely at the Buyer's risk, and that Buyer is solely responsible for compliance with all legal and regulatory requirements in connection with such use.

TI has specifically designated certain components which meet ISO/TS16949 requirements, mainly for automotive use. Components which have not been so designated are neither designed nor intended for automotive use; and TI will not be responsible for any failure of such components to meet such requirements.

Products

Audio	www.ti.com/audio
Amplifiers	amplifier.ti.com
Data Converters	dataconverter.ti.com
DLP® Products	www.dlp.com
DSP	dsp.ti.com
Clocks and Timers	www.ti.com/clocks
Interface	interface.ti.com
Logic	logic.ti.com
Power Mgmt	power.ti.com
Microcontrollers	microcontroller.ti.com
RFID	www.ti-rfid.com
OMAP Applications Processors	www.ti.com/omap
Wireless Connectivity	www.ti.com/wirelessconnectivity

Applications

Automotive and Transportation	www.ti.com/automotive
Communications and Telecom	www.ti.com/communications
Computers and Peripherals	www.ti.com/computers
Consumer Electronics	www.ti.com/consumer-apps
Energy and Lighting	www.ti.com/energy
Industrial	www.ti.com/industrial
Medical	www.ti.com/medical
Security	www.ti.com/security
Space, Avionics and Defense	www.ti.com/space-avionics-defense
Video and Imaging	www.ti.com/video

TI E2E Community

e2e.ti.com