

HCSE01000AS71S

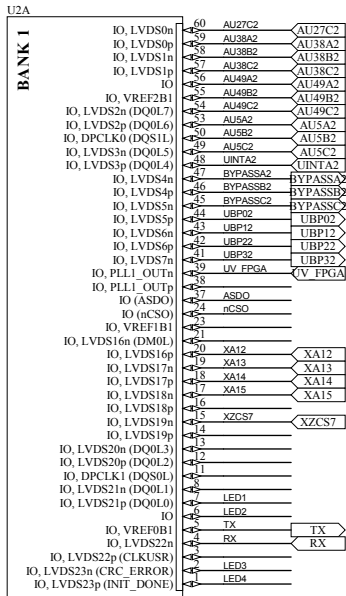

EPIC12Q24017N

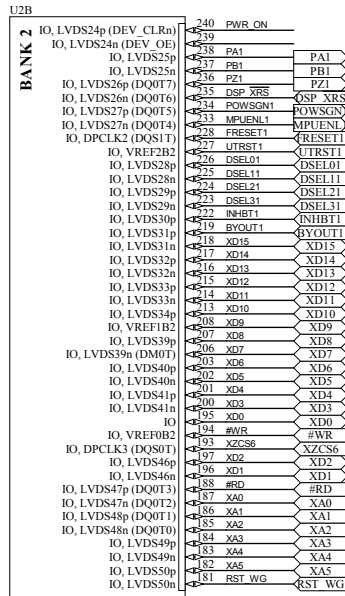

EPIC12Q24017N

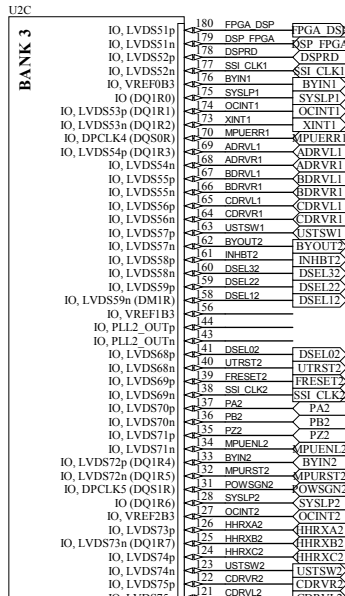

EPIC12Q24017N

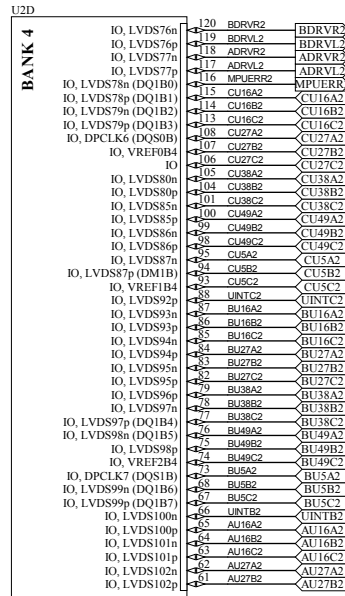

EPIC12Q24017N

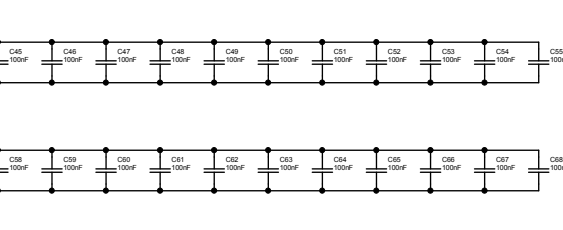
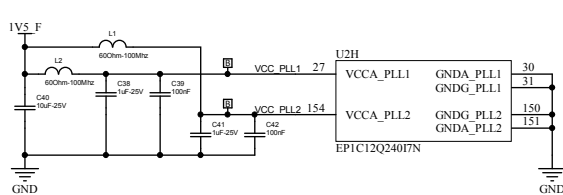
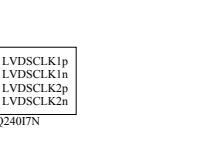
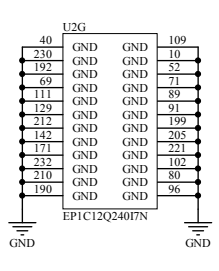
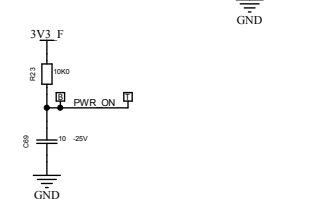
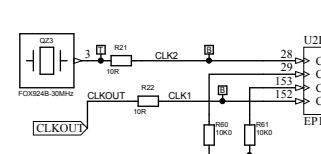
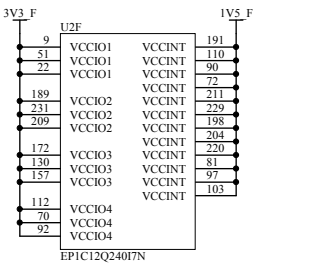
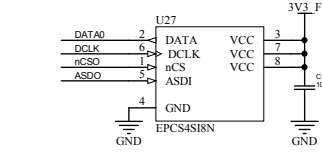
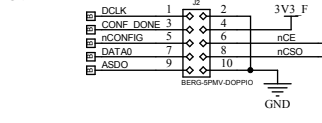
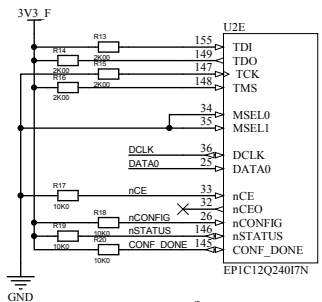
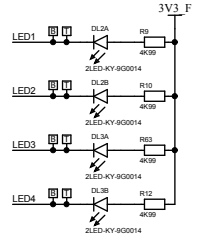

旧底图总号		更改数量	更改单号	签名	日期	更改数量	更改单号	签名	日期	更改数量	更改单号	签名	日期
底图总号		拟制				审核				FPGA			
签名日期		标准化				批准				等级标记	第4张	共5张	
格式(3)		制图:				描图:				512.SY0001.03SCH			