

5V DCDC

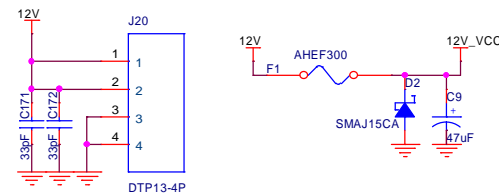

3V8 DCDC

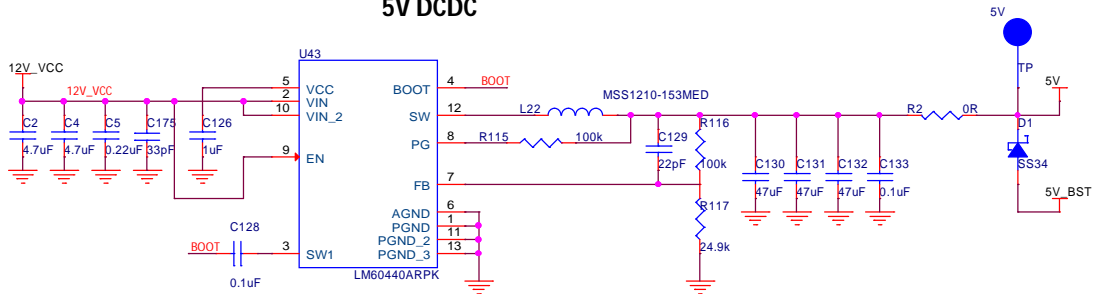
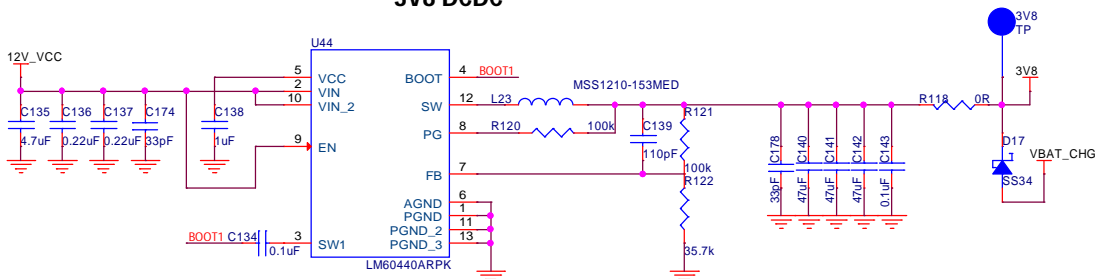

CONNECTORS

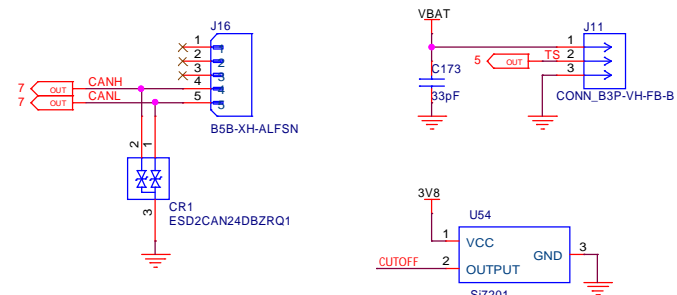

3V3 DCDC

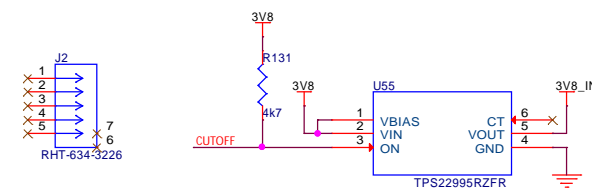
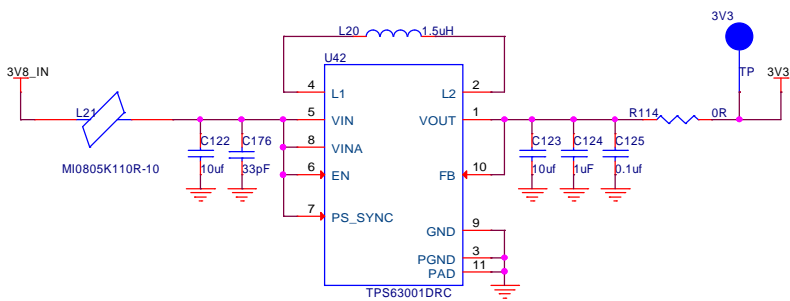

1V8 DCDC

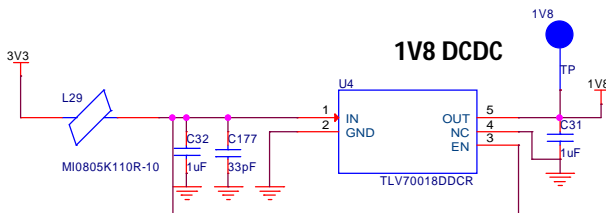

TMG 2.1 NMEA BOARD

Title		0004_POWER SUPPLY			
Size B	Document Number	JT072023001TMGMM			
Date:	Wednesday, December 06, 2023	Sheet	4	of	14