

Bode 100 - Application Note

DC/DC Converter Stability Measurement

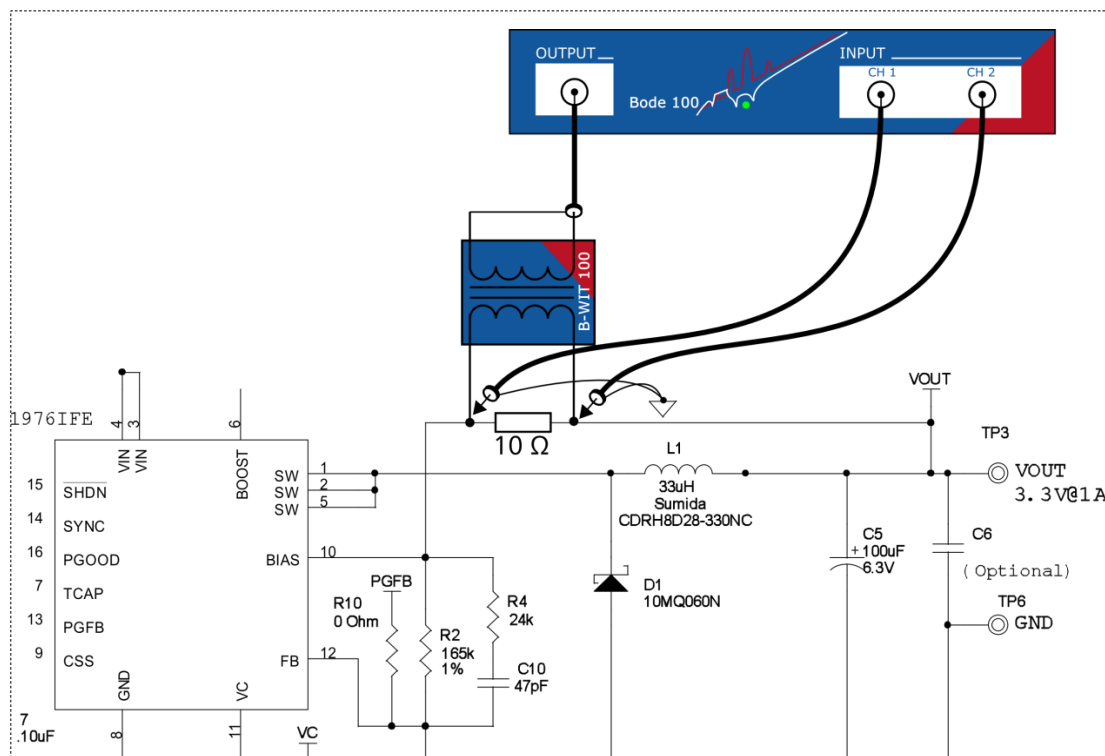

Strongly supported by



By Stephan Synkule, Lukas Heinzle & Florian Hämmerle

© 2018 by OMICRON Lab – V3.3

Visit www.omicron-lab.com for more information.

Contact support@omicron-lab.com for technical support.

Table of Contents

1	INTRODUCTION.....	3
2	MEASUREMENT SETUP	4
	2.1 THE CIRCUIT UNDER TEST	4
	2.2 SELECTING THE INJECTION POINT.....	5
	2.3 CONNECTING THE BODE 100	6
	2.4 PHASE MARGIN AND GAIN MARGIN.....	8
3	DEVICE CONFIGURATION.....	9
4	MEASUREMENT & RESULTS.....	10
	4.1 CALIBRATION.....	10
	4.2 SHAPED LEVEL	12
	4.3 INJECTION LEVEL	14
	4.4 SUPPLY VOLTAGE INFLUENCE.....	15
	4.5 LOAD CURRENT INFLUENCE	16
5	CONCLUSION	17

Note: Basic procedures such as setting-up, adjusting and calibrating the Bode 100 are described in the Bode 100 user manual. You can download the Bode 100 user manual at www.omicron-lab.com/bode-100/downloads#3

Note: All measurements in this application note have been performed with the Bode Analyzer Suite V3.12. Use this version or a higher version to perform the measurements shown in this document. You can download the latest version at www.omicron-lab.com/bode-100/downloads

1 Introduction

In this application note we show you how to analyze the stability respectively the control loop behavior of a switched mode power supply such as a step-down DC/DC converter.

To guarantee a stable output voltage of a power supply and to reduce the influence of supply voltage variations and load changes on the output voltage of a power supply, a compensating controller is necessary. The quality of the design of this control circuit determines the stability and dynamic response of the entire DC/DC converter system.

The following pages show you how you can measure the loop response of such control systems using the Bode 100 vector network analyzer in combination with the B-WIT 100 wideband injection transformer.

For the characterization of the loop we measure the open loop gain by using the voltage injection method. This method is commonly used to analyze the control loop stability of voltage regulators such as switched mode power supplies.

In this document, we will discuss the following points in detail:

- How to choose the correct injection point to measure the loop gain
- Determining gain margin and phase margin from the frequency response
- How do supply voltage and load current influence the systems dynamics
- Using the shaped level feature of the Bode 100 to improve the measurement results

2 Measurement Setup

2.1 The Circuit under Test

The demo board 481A is a step-down buck converter featuring the LT1976. The output is optimized for 3.3 V at a load current of 1 A. The following figure shows the schematics of the demo board 481A. Detailed information on the demo circuit can be found at <http://www.linear.com>.

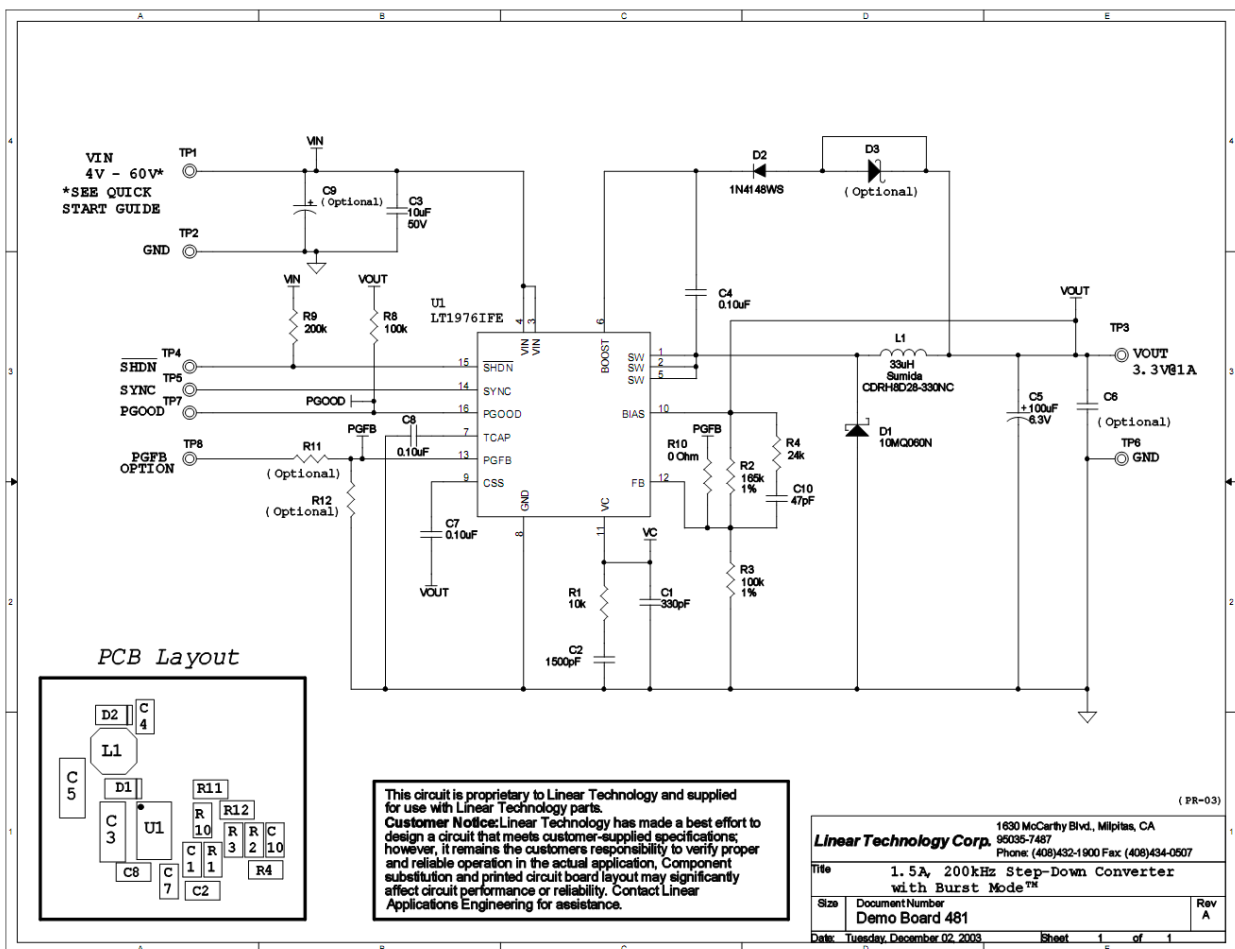
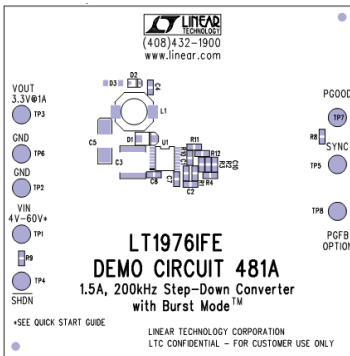

Figure 1: LT 481A demo board schematics

2.2 Selecting the Injection Point

To measure the loop gain of a voltage feedback loop we need to break the loop at a suitable point and inject a disturbance signal at this point. The disturbance signal will be distributed around the loop and depending on the loop gain the signal will be amplified or attenuated and shifted in phase. The Bode 100 output will provide the disturbance signal whereas the inputs will measure the transfer function of the loop.

To ensure that the measured loop gain equals the real loop gain we need to choose a suitable point. First, we need to find a point where the loop is restricted to one single path to make sure that there are no parallel signal flows. Then we need to make sure that at this point the impedance looking in the direction of the loop is much bigger than the impedance looking backwards.

The following figure shows the feedback loop of the circuit and indicates the suitable injection point. The impedance looking backwards equals the output impedance of the converter which is very low (in the range of several $m\Omega$). The impedance looking in direction of the loop is formed by the compensator and the voltage divider and is in the range of several $k\Omega$.

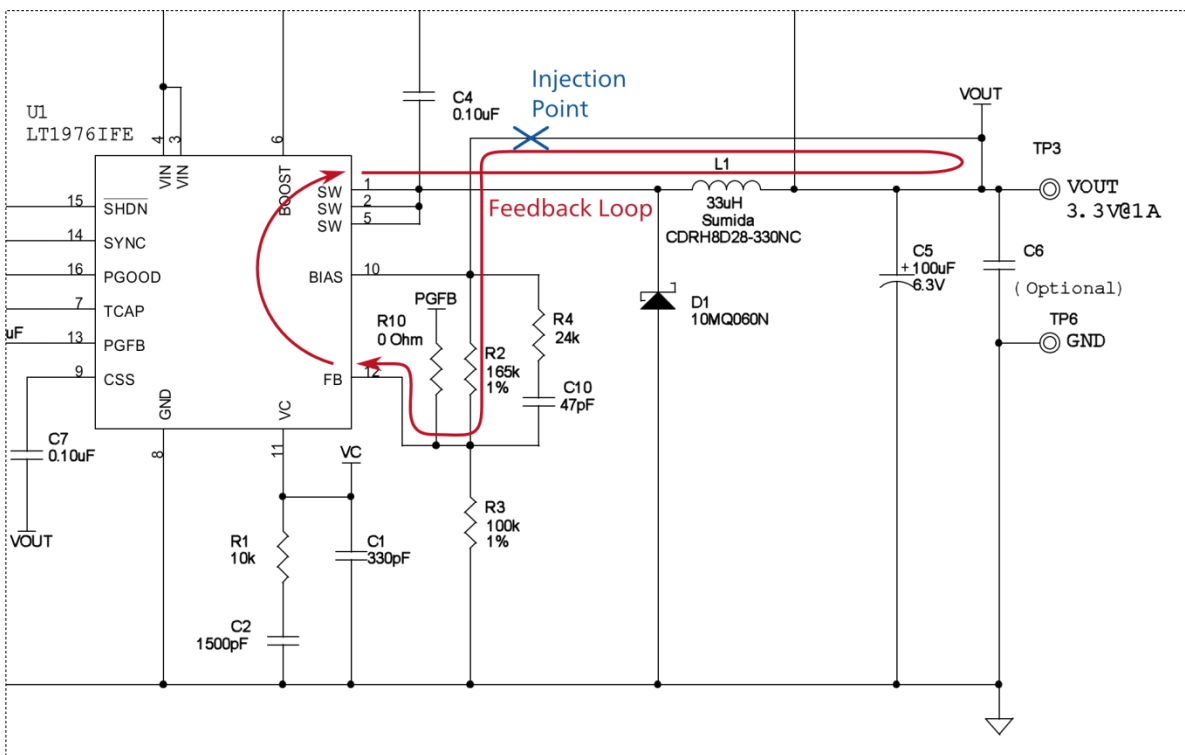

Figure 2: Feedback loop and injection point

More details on the selection of the injection point and the theory of the voltage injection method can be found in the article “Loop Gain Measurement” (Good to know section) which is available for download at: <http://www.omicron-lab.com/bode-100/application-notes-know-how/articles-use-cases.html>

2.3 Connecting the Bode 100

We have selected the injection point and now need to break the loop at this point. To ensure that the measurement does not change our system behavior we place a small resistor at the injection point that does not significantly change the feedback divider. In this case, we use a 10 Ω resistor.

The disturbance voltage is applied in parallel to the injection resistor using the B-WIT 100 injection transformer. The transformer is necessary to isolate the output of the Bode 100 from the DC operating point of the feedback loop. The following figure shows how the Bode 100 is connected to the circuit.

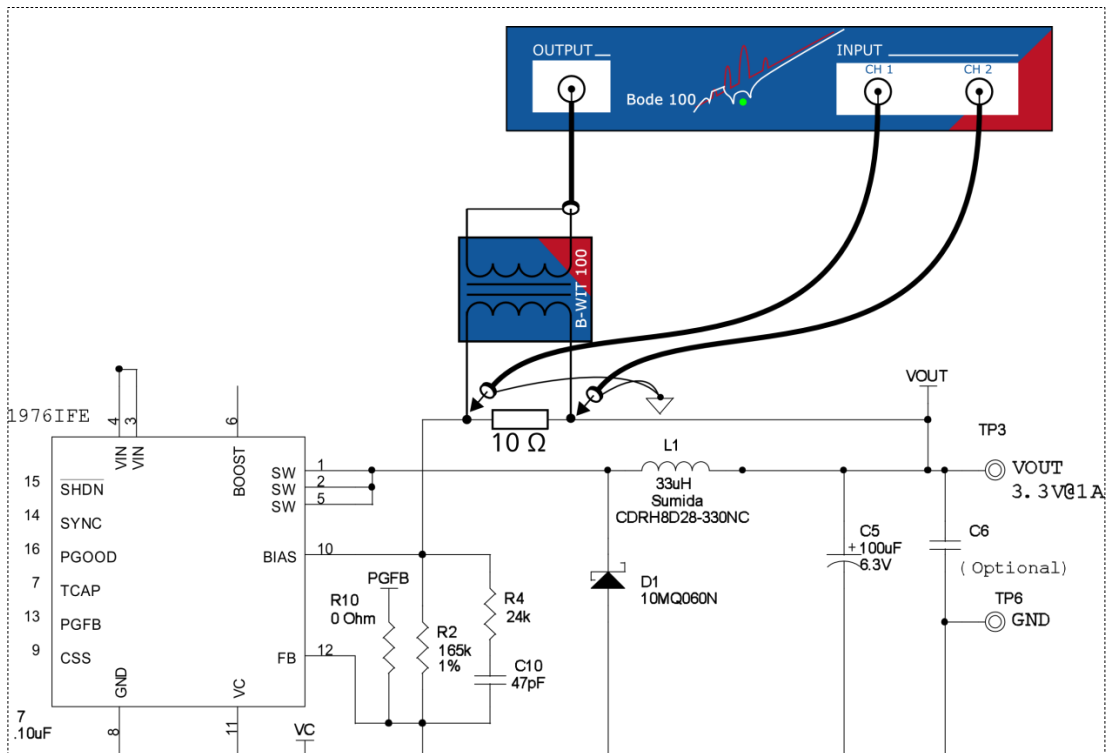

Figure 3: Connecting the Bode 100 to measure the loop response of the regulator

The inputs of the Bode 100 are connected to either side of the injection transformer. CH1 measures the disturbance signal that is applied to the feedback divider and CH2 measures the signal that appears at the output of the converter. By dividing the voltage at CH2 by the voltage at CH1 we get the transfer function from the feedback input to the output of the power supply. This transfer function we call the loop gain $T(j\omega)$.

$$T(j\omega) = \frac{V_{CH2}}{V_{CH1}}$$

Note: We recommend to use the PML-111O 10:1 probes from OMICRON Lab to pick up the signals, but any standard oscilloscope probe could also be used for this measurement.

Attention: If hazardous voltages are present, make sure that suitable probes (differential probes) are used to protect operator and device from any dangerous voltages!

To ensure good measurement results it is strongly recommended to place the injection resistor, the injection transformer and the probes close to the circuit to keep leads short.

Furthermore, it is very important to avoid mechanical stress at soldering pads to prevent damage to the test object. The following figures show how we have realized the modification on the demo board and how the probes and the injection transformer are connected to the circuit.

Note: Here are the properties of the devices you need additionally for the setup.

- Power Supply: 5 V
- Load Resistor: Adjustable value for 1 A @ Ampere meter

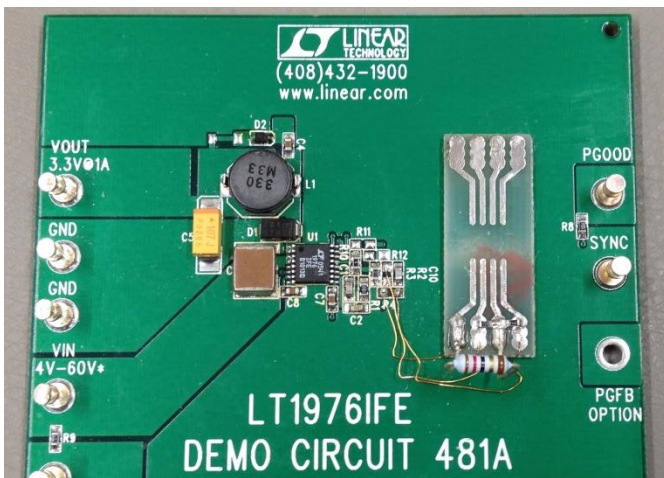

Figure 4: Demo board prepared for connecting the measurement equipment

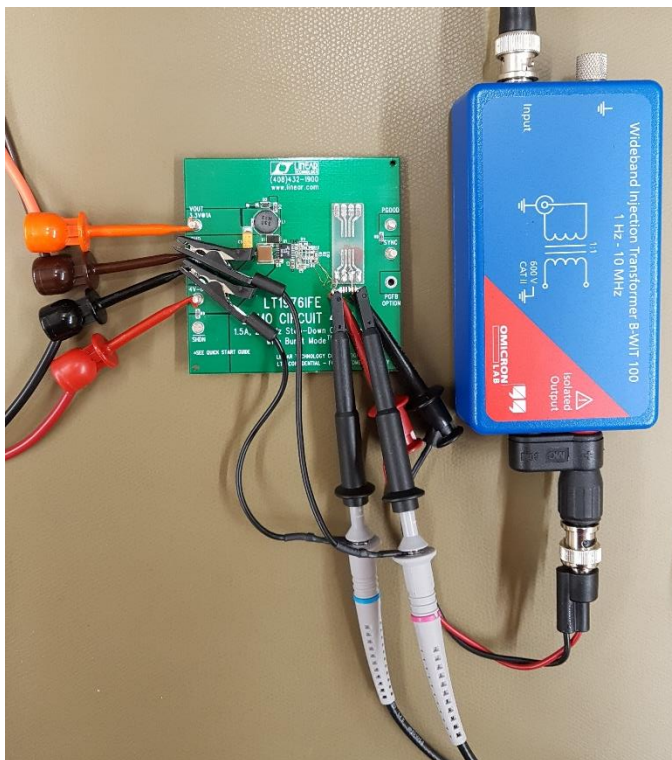

Figure 5: The probes and the injection transformer connected to the circuit

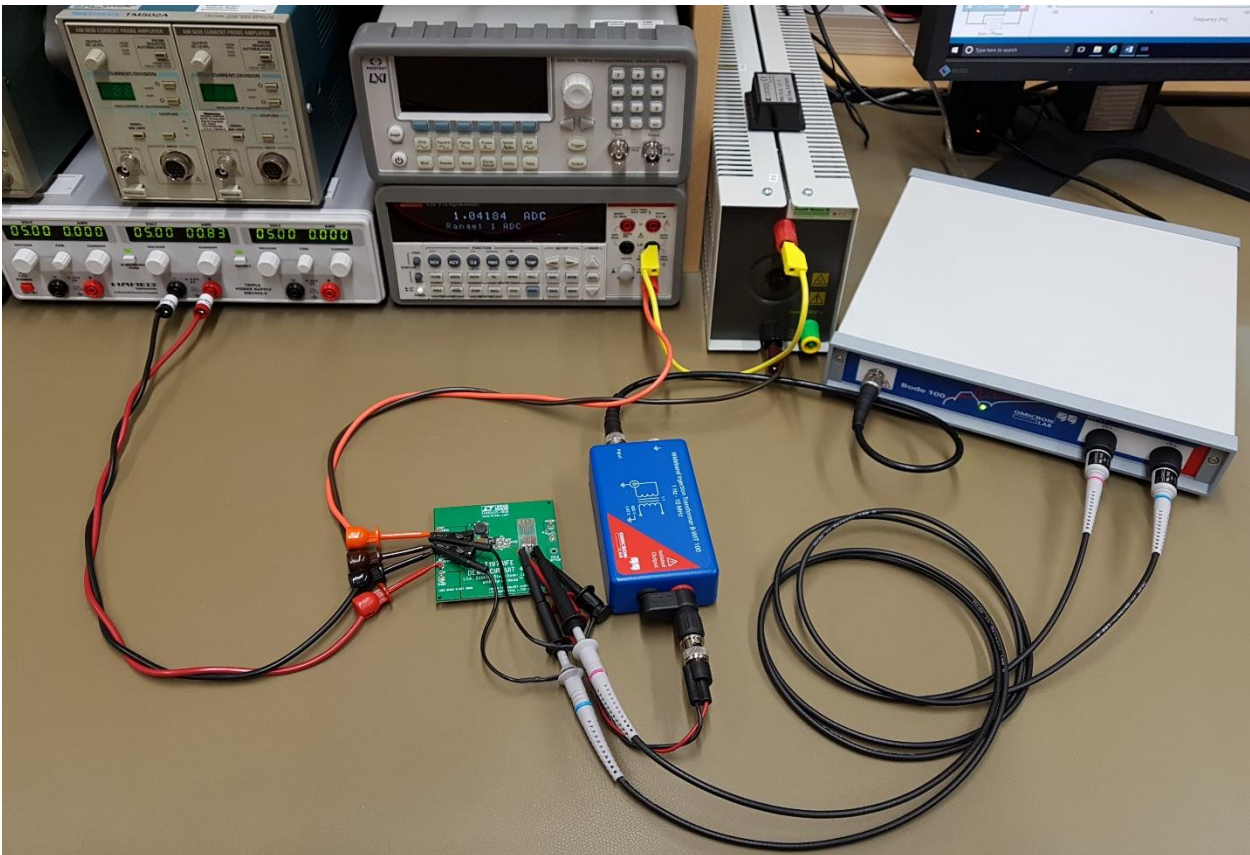

Figure 6: Measurement setup with power supply, resistive load, Ampere meter and Bode 100

2.4 Phase Margin and Gain Margin

According to Nyquist, the stability of a feedback system can be verified by checking two critical points. These are the Gain crossover point where the **Phase Margin** is measured and the Phase crossover point where the **Gain Margin** is determined.

Note: When analyzing the open loop gain for stability as it is done in text-books, positive feedback occurs at -180° phase. Therefore, the phase margin is measured by determining the phase difference to -180° .

In **this measurement** we measure the open loop gain in a **closed loop system**. The phase margin must therefore be measured **relatively to the 0° line!**

This is somehow confusing but gets clearer if you imagine a signal that is injected at the feedback input and appears at the output without any phase shift. Such a signal that passed the loop with 0° phase will again be injected at the feedback and sum up with the previous one. This is exactly the point where positive feedback and therefore instability will occur in a negative feedback system.

3 Device Configuration

To measure the transfer function of the loop, we need to set up the Bode 100 correctly. The measurement of the loop gain is performed in the Gain / Phase mode of the Bode Analyzer Suite:

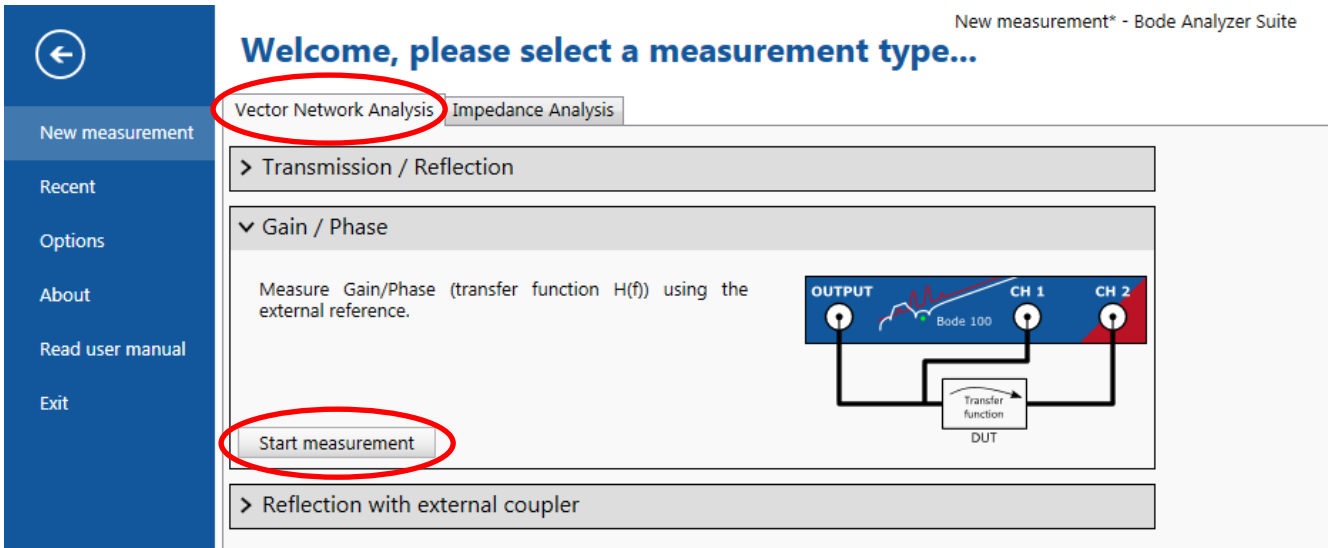

Figure 7: Start menu

The following settings are applied:

- Start Frequency: 100 Hz
- Stop Frequency: 200 kHz
- Sweep Mode: Logarithmic
- Number of Points: 201 or more
- Level: -20 dBm
- Attenuator CH1 & CH2: 0 dB
- Receiver Bandwidth: 30 Hz

Trace 1 & 2 are set up as shown below to display a Bode-plot:

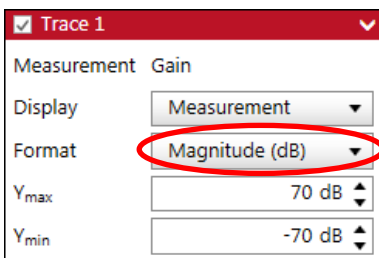

Figure 8: Settings Trace 1

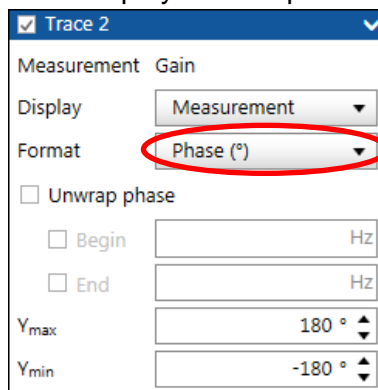

Figure 9: Settings Trace 2

4 Measurement & Results

4.1 Calibration

Calibration is necessary if the two probes, used to connect the Bode 100 to the circuit, have a different frequency response. This differences in the frequency response will introduce phase and gain errors in the measurement.

If you are not sure if your probes are similar, perform a simple check.

Check if calibration is required:

To check if calibration is required, both probes must be connected to the same signal. This can be done by placing them at the same side of the injection resistor as shown in the picture below or by directly connecting the probes to the OUTPUT signal of Bode 100.



Figure 10: Both probes connected to the same point

After connecting the probes, a measurement is started by pressing the single sweep button.  Single

The measurement should result in a flat line at 0 dB and 0°. This indicates that both probes have the same frequency response and an additional calibration is not required.

The measurement graphs on the following page show a typical measurement with similar probes that don't require calibration.

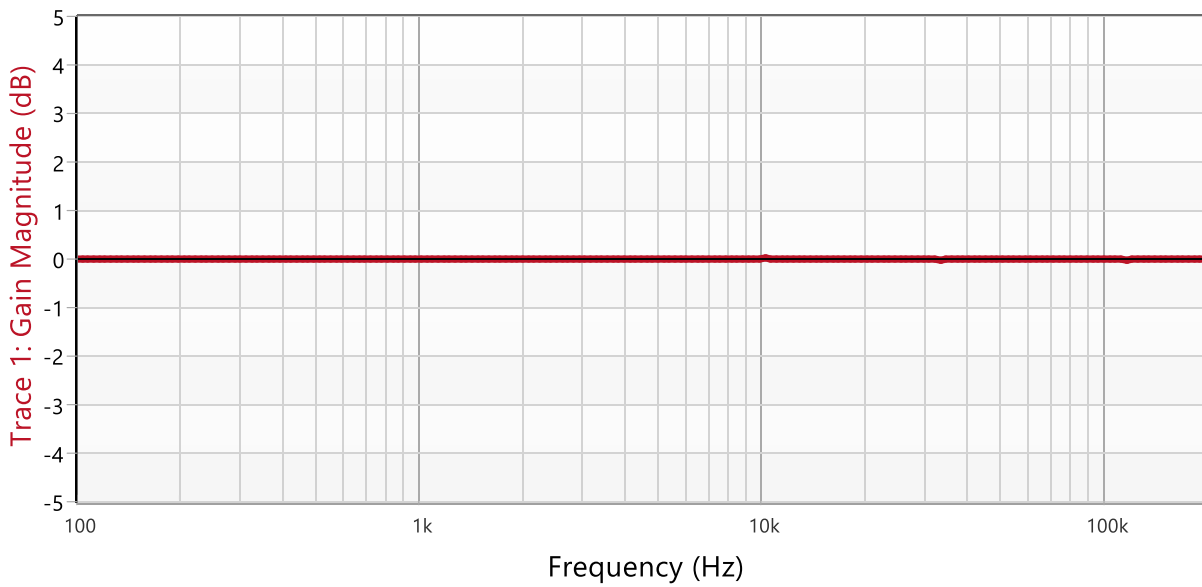

Figure 11: Flat 0dB Gain curve shows that no additional calibration is required

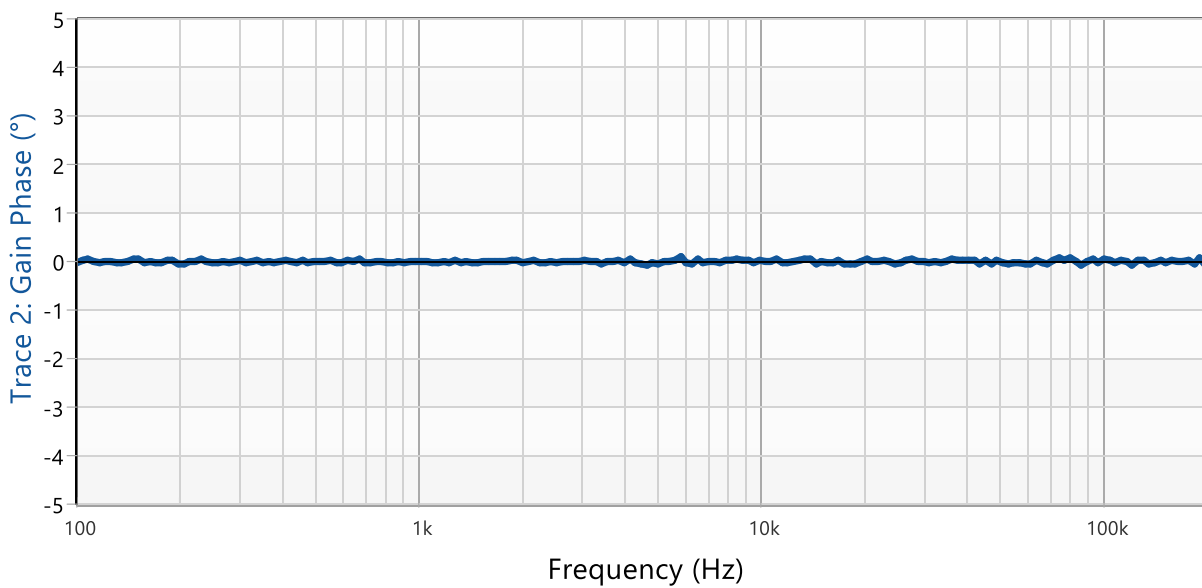

Figure 12: Flat 0° Phase curve shows that no additional calibration is required

Performing a Calibration

If your measurement result deviates strongly from 0 dB and 0°, please perform a THRU calibration. You can find more information about how to perform a calibration in the Bode 100 User Manual.

Note: Noise cannot be removed by a calibration! To fight noise, increase the signal level, reduce the input attenuators, reduce receiver bandwidth and improve test setup connections.

4.2 Shaped Level

We perform the first stability measurement with a supply voltage of 12 V and a load current of 1 A. Please do not use electronic loads for frequency response measurements as the control circuit of the electronic load could interfere with the circuit under test.

Starting a frequency sweep with an injection level of -20 dBm leads to the following bode-plot.

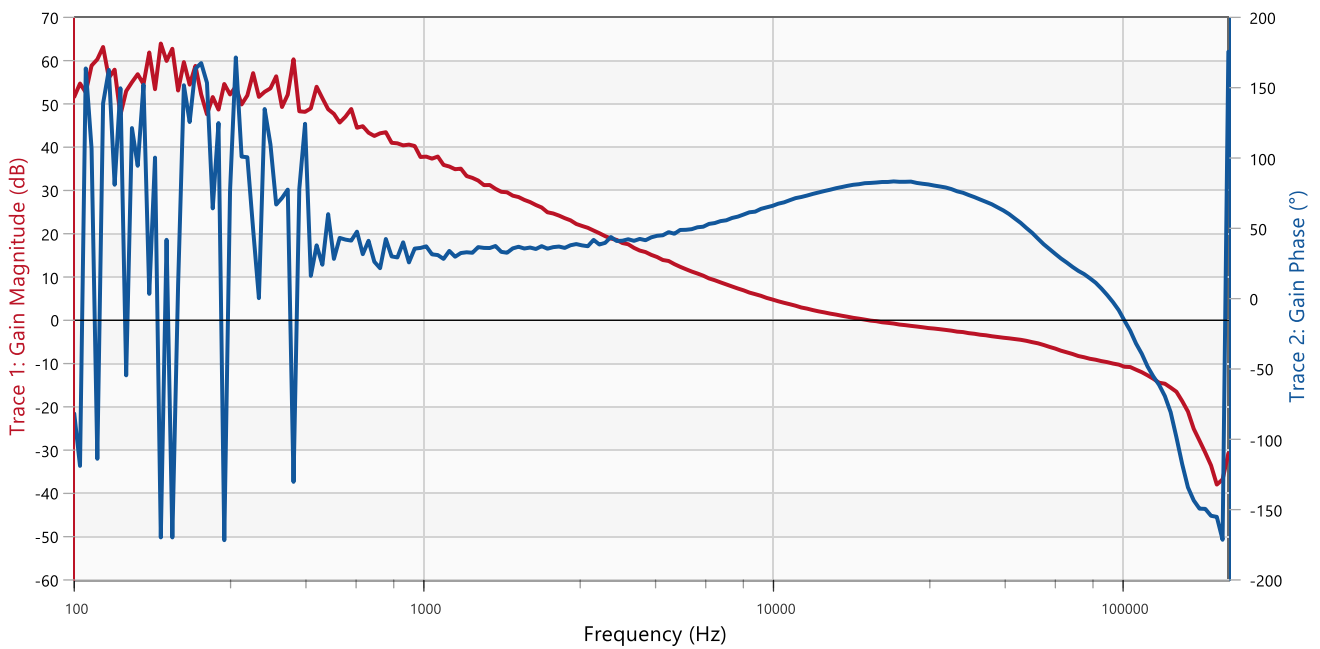

Figure 13: Loop gain curve

The red line shows the gain magnitude and the blue curve the gain phase. Above 1 kHz the result does not show much noise whereas in the lower frequencies the curve is very noisy. The reason is the very small injection level and the high gain of ≈ 60 dB. To reduce the noise in the low frequency range we use the **shaped level** feature of the Bode 100.

On the left-hand side in the Bode Analyzer Suite, set the output level of the Bode 100 from Constant to Variable. A “Shaped Level” button will appear. By clicking this button the shaped level can be entered in the Shaped Level window.

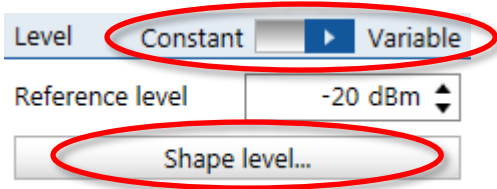

Figure 14: Reference level

We set the reference level to -20 dBm and increase the output level from 100 Hz to 500 Hz from -20 dBm to 0 dBm by entering a delta level of $+20$ dB or double clicking on the diagram to set a point.

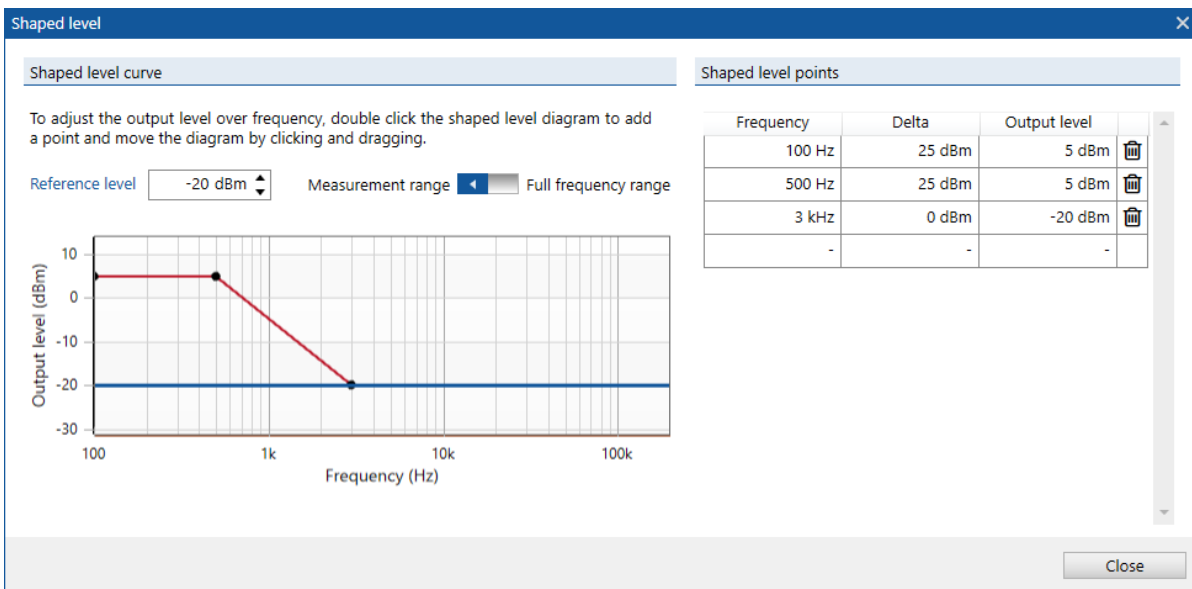

Figure 15: Shaped level - window

Restarting the measurement leads to the following gain / phase curve.

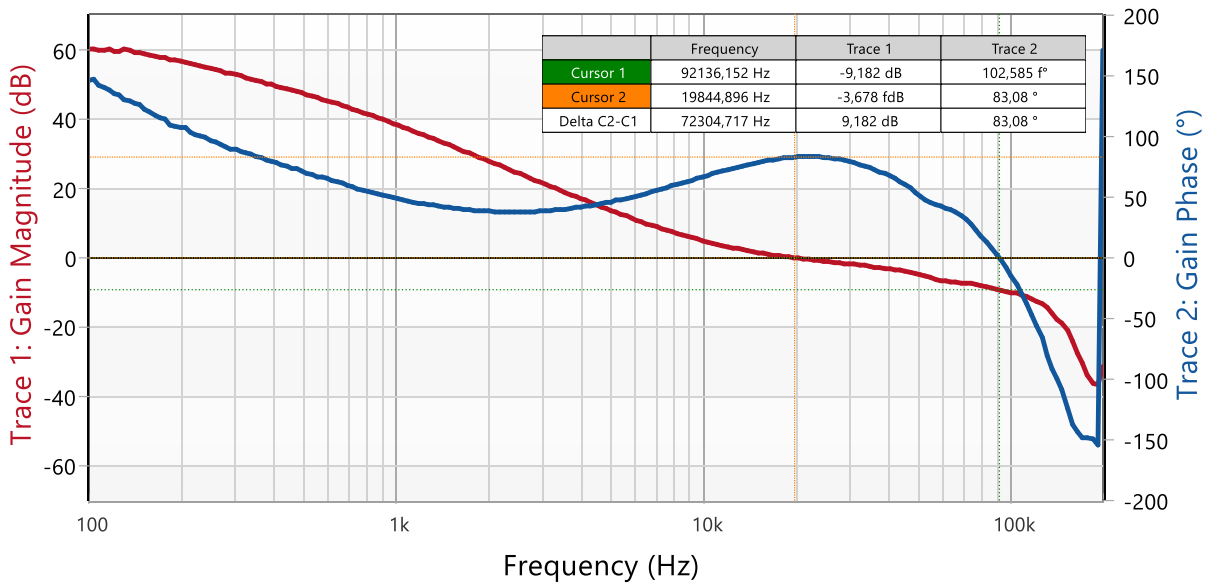

Figure 16: loop gain measurement (12 V Input voltage and 1 A load current)

By using the cursors, we can read the Gain Margin and Phase Margin of the system. The measurement indicates a Phase Margin of $PM = 83.1^\circ$ and a Gain Margin of $GM = 9.2$ dB.

4.3 Injection Level

You may have noticed that we use a very low output level of -20 dBm for this measurement. The reason is that we want to analyze the small signal behavior of the regulator. Some regulators are very sensitive to the injected level and show nonlinearities or big-signal effects if the injected level is too high. If we i.e. set the load of the DUT so it results in 80 mA and use an output level of -18 dBm for the measurement, the result will be erroneous as shown below:

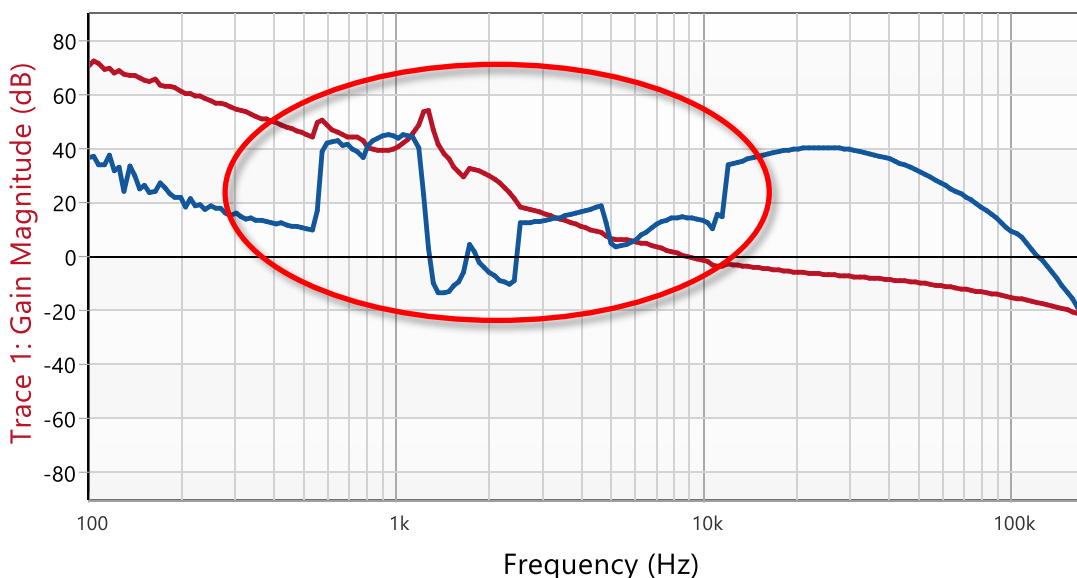

Figure 17: big signal effects (nonlinearities) due to excessive injection signal

Such erroneous measurements can be avoided by reducing the injection signal level. The shaped level feature provides the possibility to reduce the output level exactly at the frequencies where it is necessary.

4.4 Supply Voltage Influence

With our next measurement, we will check how supply voltage changes influence the characteristic of the LT1976 control circuit. To do so, we change the supply voltage to 5 V. Restarting the sweep and placing the cursors again at the 0 dB and 0° points leads to the following graph.

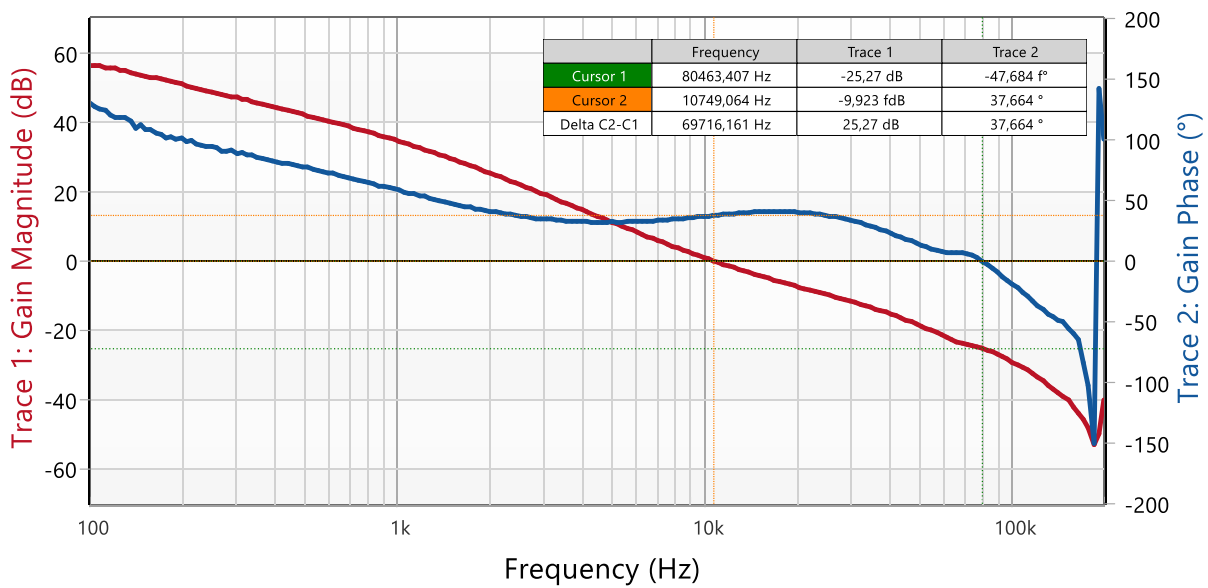

Figure 18: loop gain measurement (5 V Input voltage and 1 A load current)

The phase margin did decrease to $PM = 37.7^\circ$ whereas the gain margin did increase to $GM = 25.3$ dB.

4.5 Load Current Influence

By varying the load current and keeping the supply voltage of the regulator constant we can check the sensitivity of the system to different load currents. The following graph shows the loop gain measurement at different load currents. All measurements were performed with a supply voltage of 12 V.

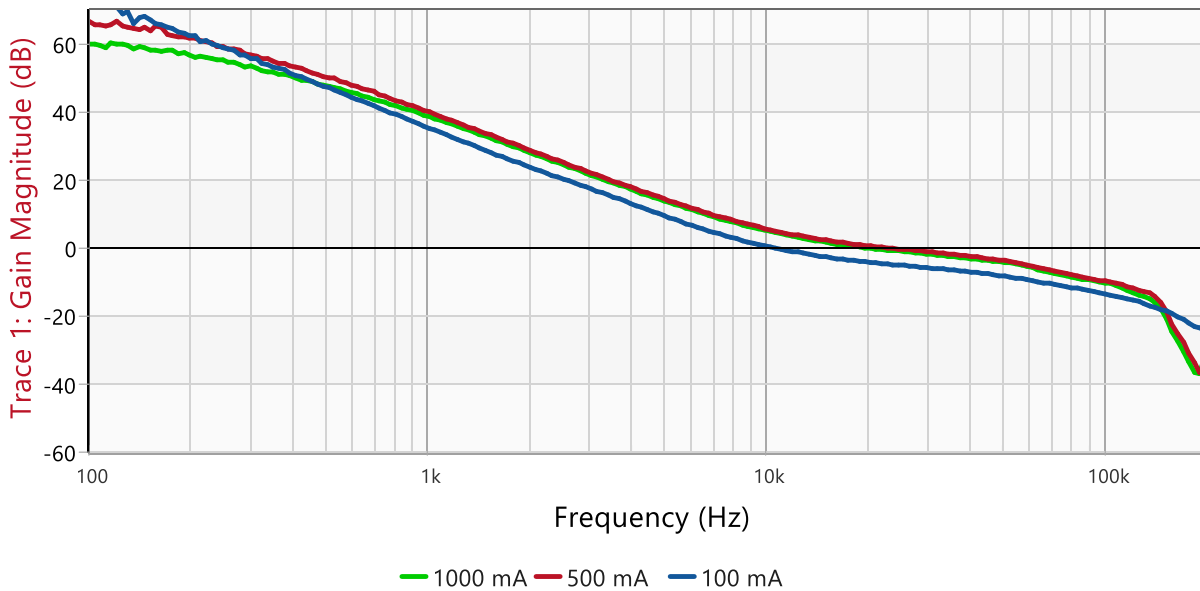

Figure 19: Loop gain measurement result – Magnitude (dB)

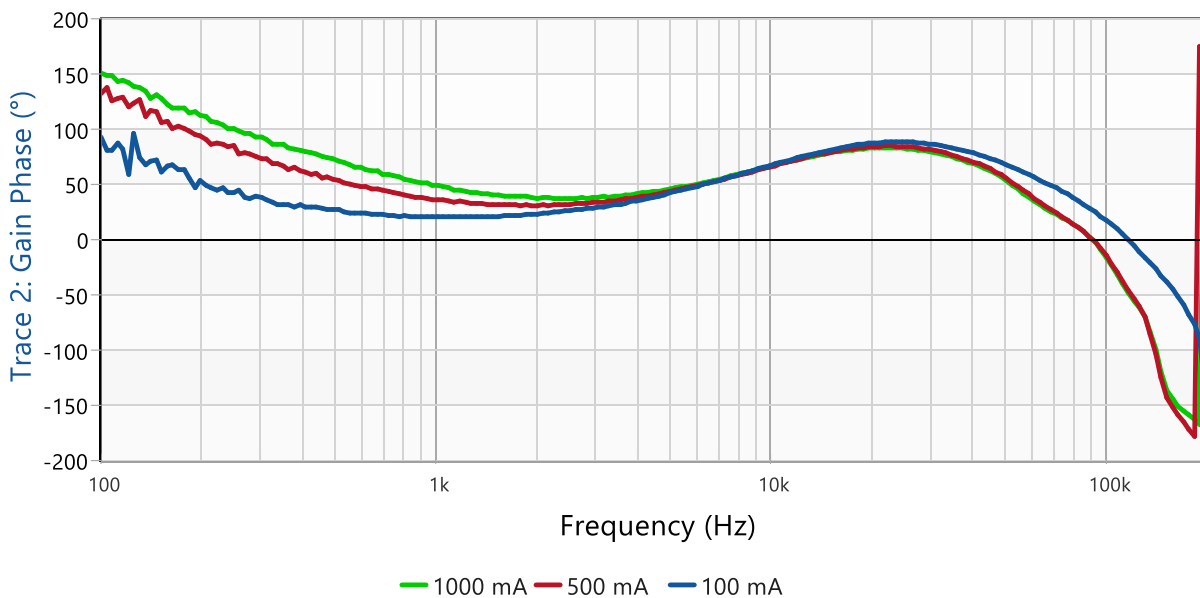

Figure 20: Loop gain measurement result - Phase (°)

5 Conclusion

The Bode 100 in combination with the B-WIT 100 wideband injection transformer offers a perfect toolkit for the quick and easy stability analysis of control systems. It enables to measure the gain margin and phase margin of control systems such as switched mode power supplies or linear regulators. Gain margin and phase margin are widely accepted indicators for the stability of a control loop.

Furthermore, the Bode Analyzer Suite provides great functionality to display the system response on changing operating conditions such as supply voltage changes or load current changes. To ensure stability of a power supply in the field the combination of all acceptable load and environmental conditions must be tested. This provides detailed information on the dynamic behavior of a DC/DC converter in various operating conditions.



OMICRON Lab is a division of OMICRON electronics specialized in providing Smart Measurement Solutions to professionals such as scientists, engineers and teachers engaged in the field of electronics. It simplifies measurement tasks and provides its customers with more time to focus on their real business.

OMICRON Lab was established in 2006 and is meanwhile serving customers in more than 40 countries. Offices in America, Europe, East Asia and an international network of distributors enable a fast and extraordinary customer support.

OMICRON Lab products stand for high quality offered at the best price/value ratio on the market. The products' reliability and ease of use guarantee trouble-free operation. Close customer relationship and more than 25 years in-house experience enable the development of innovative products close to the field.

Europe, Middle East, Africa
OMICRON electronics GmbH
Phone: +43 59495
Fax: +43 59495 9999

Asia Pacific
OMICRON electronics Asia Limited
Phone: +852 3767 5500
Fax: +852 3767 5400

Americas
OMICRON electronics Corp. USA
Phone: +1 713 830-4660
Fax: +1 713 830-4661