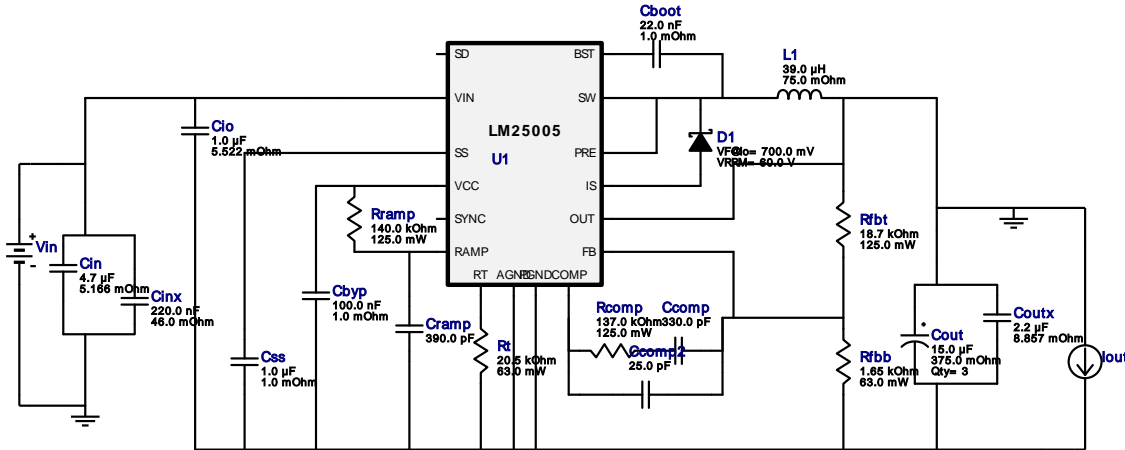

WEBENCH® Design Report

 Design : 23 LM25005MHX/NOPB
 LM25005MHX/NOPB 10.0V-14.0V to -15.00V @ 0.5A

 Vout = -15.0V
 Iout = 0.5A

Electrical BOM

Name	Manufacturer	Part Number	Properties	Qty	Price	Footprint
Cboot	MuRata	GCM155R71H223KA55D Series= C0G/NP0	Cap= 22.0 nF ESR= 1.0 mOhm VDC= 50.0 V IRMS= 0.0 A	1	\$0.01	0402 3 mm ²
Cbyp	Taiyo Yuden	EMK107B7104KA-T Series= X7R	Cap= 100.0 nF ESR= 1.0 mOhm VDC= 16.0 V IRMS= 0.0 A	1	\$0.01	0603 5 mm ²
Ccomp	Samsung Electro-Mechanics	CL21C331JBANNNC Series= C0G/NP0	Cap= 330.0 pF VDC= 50.0 V IRMS= 0.0 A	1	\$0.01	0805 7 mm ²
Ccomp2	Samsung Electro-Mechanics	CL21C250JBANNNC Series= C0G/NP0	Cap= 25.0 pF VDC= 50.0 V IRMS= 0.0 A	1	\$0.01	0805 7 mm ²
Cin	MuRata	GRM21BC81E475KA12L Series= X6S	Cap= 4.7 uF ESR= 5.166 mOhm VDC= 25.0 V IRMS= 2.03531 A	1	\$0.03	0805 7 mm ²
Cinx	Kemet	C0805C224K5RACTU Series= X7R	Cap= 220.0 nF ESR= 46.0 mOhm VDC= 50.0 V IRMS= 2.65 A	1	\$0.03	0805 7 mm ²
Cio	TDK	C1608X5R1H105K080AB Series= X5R	Cap= 1.0 uF ESR= 5.522 mOhm VDC= 50.0 V IRMS= 2.2162 A	1	\$0.03	0603 5 mm ²
Cout	Kemet	T495C156K020ATE375 Series= T495	Cap= 15.0 uF ESR= 375.0 mOhm VDC= 20.0 V IRMS= 487.0 mA	3	\$0.74	6032-28 42 mm ²
Coutx	MuRata	GRM21BR61E225KA12L Series= X5R	Cap= 2.2 uF ESR= 8.857 mOhm VDC= 25.0 V IRMS= 1.3111 A	1	\$0.06	0805 7 mm ²

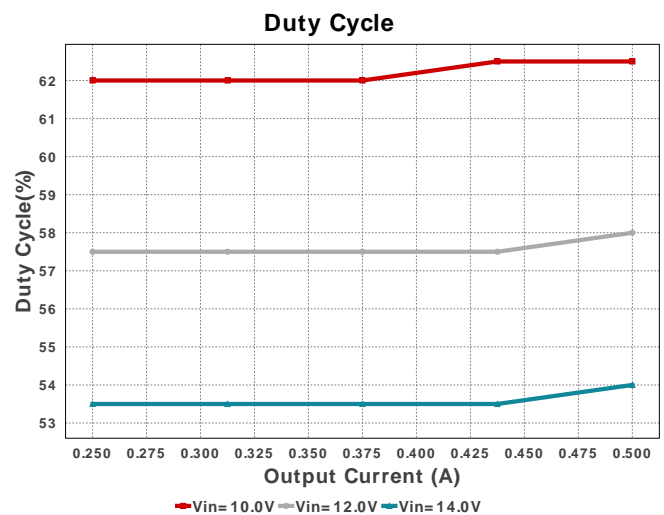
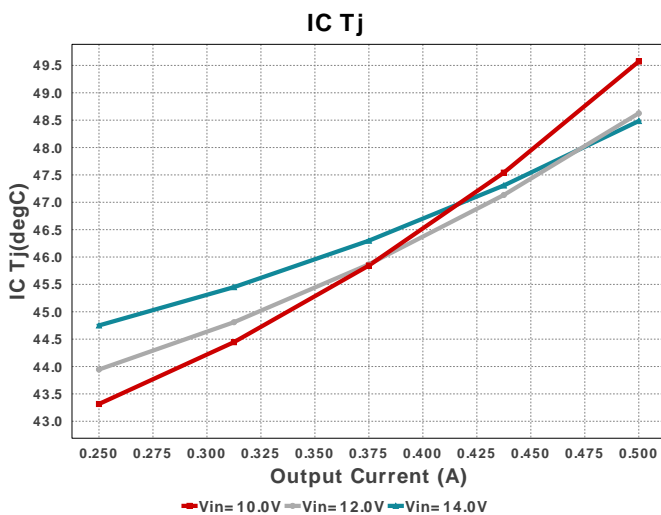
Name	Manufacturer	Part Number	Properties	Qty	Price	Footprint
Cramp	Samsung Electro-Mechanics	CL05C391JB5NNNC Series= C0G/NP0	Cap= 390.0 pF VDC= 50.0 V IRMS= 0.0 A	1	\$0.01	 0402 3 mm ²
Css	Taiyo Yuden	EMK107B7105KA-T Series= X7R	Cap= 1.0 uF ESR= 1.0 mOhm VDC= 16.0 V IRMS= 0.0 A	1	\$0.02	 0603 5 mm ²
D1	Fairchild Semiconductor	SS26FL	VF@Io= 700.0 mV VRRM= 60.0 V	1	\$0.10	 SOD-123F 12 mm ²
L1	Bourns	SDR1307-390KL	L= 39.0 uH DCR= 75.0 mOhm	1	\$0.40	 SDR1307 227 mm ²
Rcomp	Panasonic	ERJ-6ENF1373V Series= ERJ-6E	Res= 137.0 kOhm Power= 125.0 mW Tolerance= 1.0%	1	\$0.01	 0805 7 mm ²
Rfbb	Vishay-Dale	CRCW04021K65FKED Series= CRCW..e3	Res= 1.65 kOhm Power= 63.0 mW Tolerance= 1.0%	1	\$0.01	 0402 3 mm ²
Rfbt	Panasonic	ERJ-6ENF1872V Series= ERJ-6E	Res= 18.7 kOhm Power= 125.0 mW Tolerance= 1.0%	1	\$0.01	 0805 7 mm ²
Rramp	Panasonic	ERJ-6ENF1403V Series= ERJ-6E	Res= 140.0 kOhm Power= 125.0 mW Tolerance= 1.0%	1	\$0.01	 0805 7 mm ²
Rt	Vishay-Dale	CRCW040220K5FKED Series= CRCW..e3	Res= 20.5 kOhm Power= 63.0 mW Tolerance= 1.0%	1	\$0.01	 0402 3 mm ²
U1	Texas Instruments	LM25005MHX/NOPB	Switcher	1	\$1.40	 MXA20A 71 mm ²

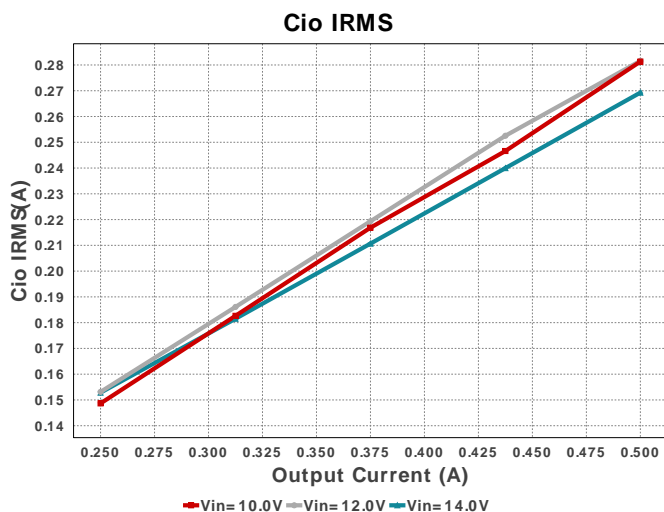
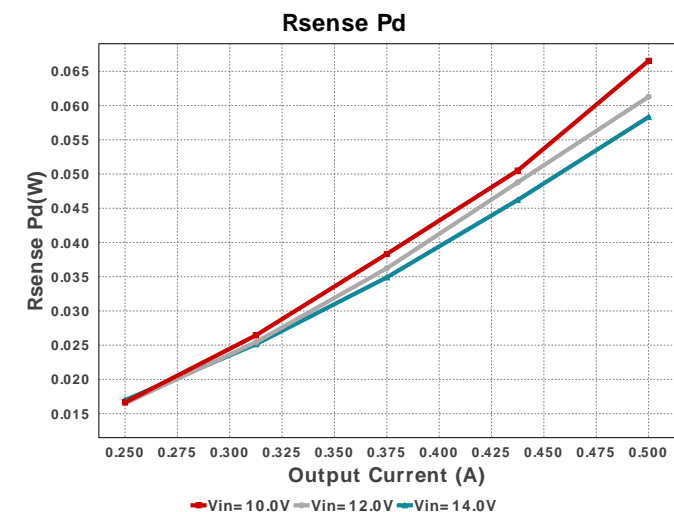
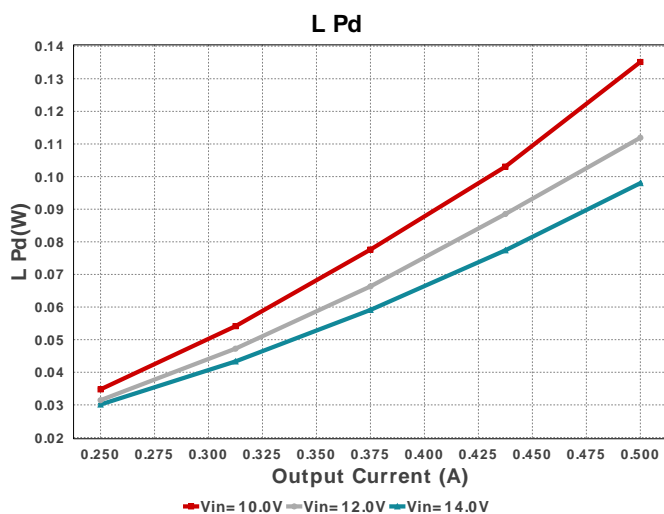
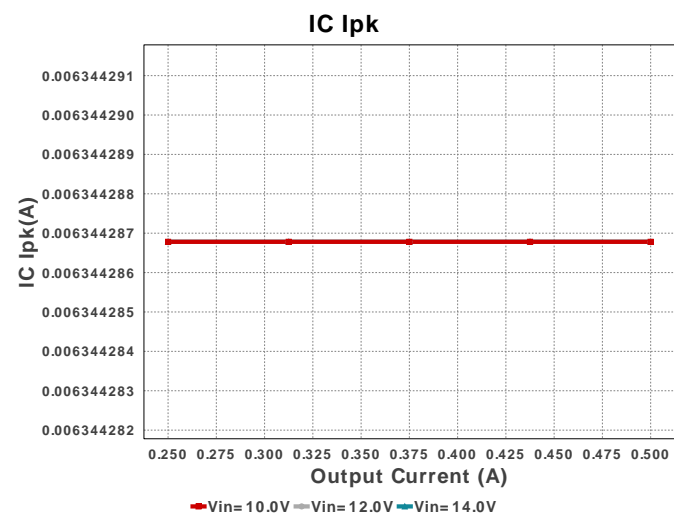
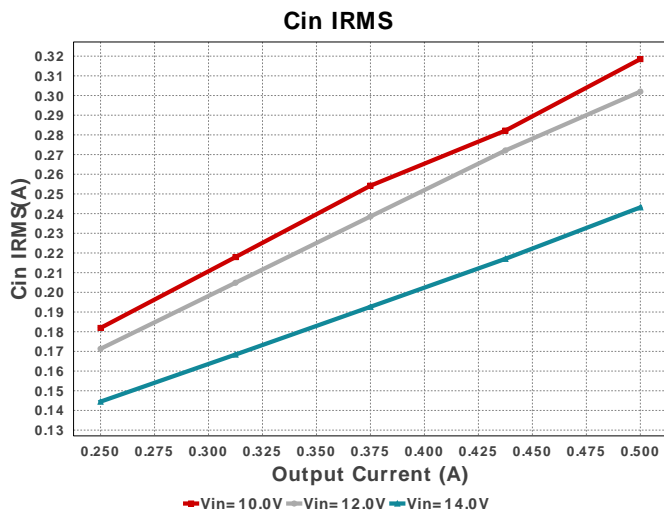
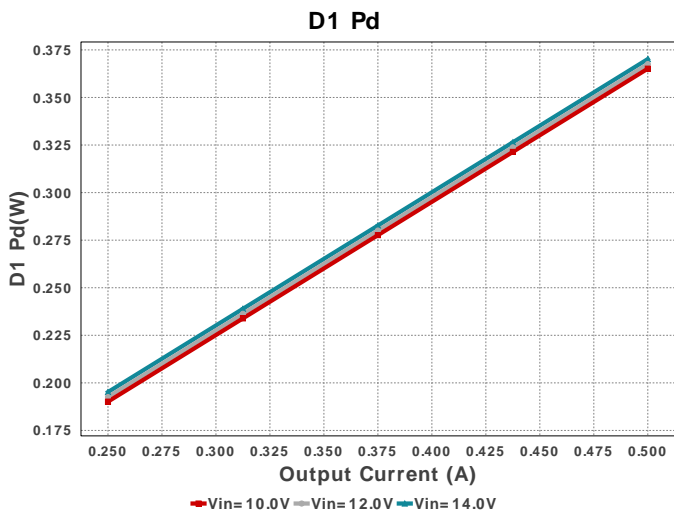

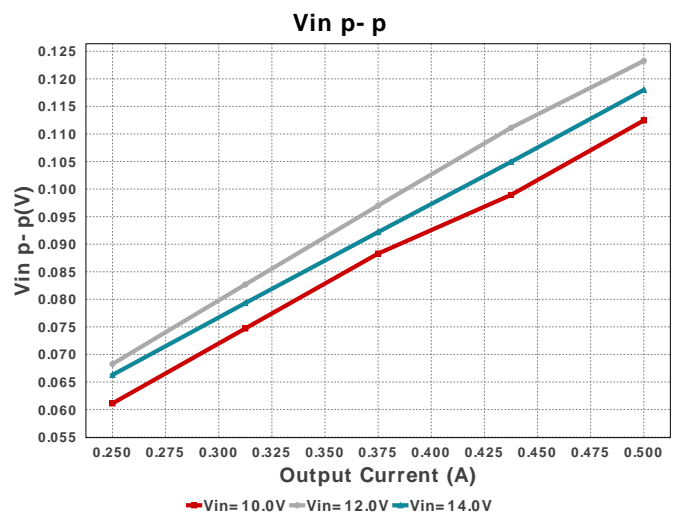
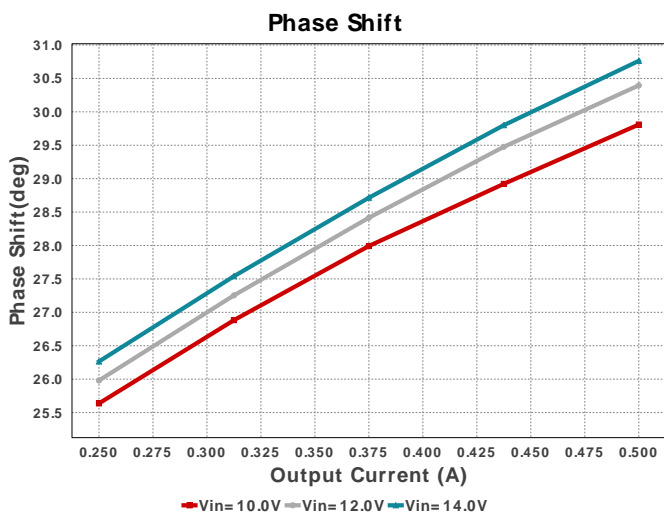
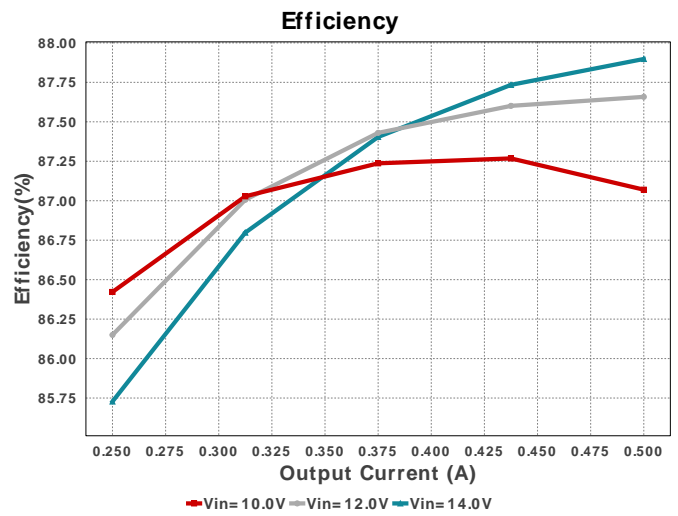
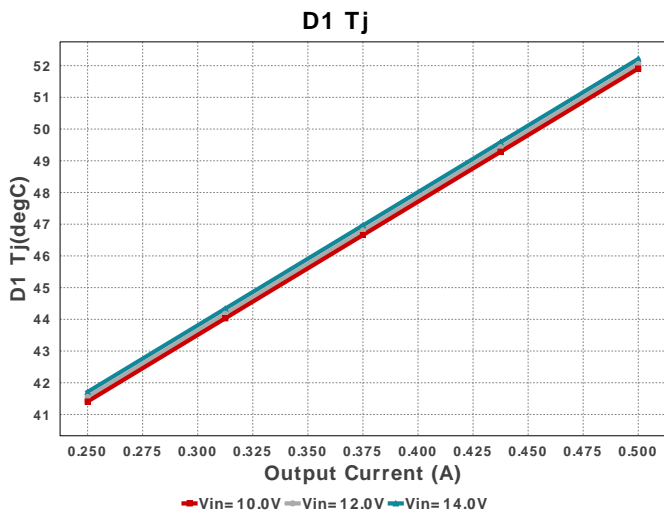
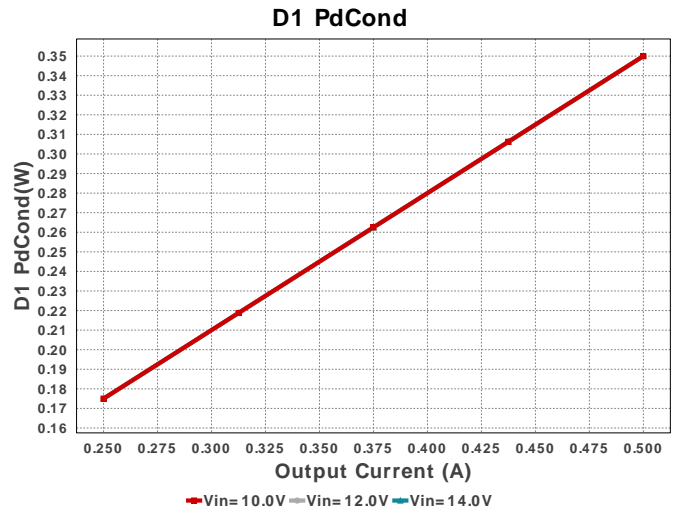
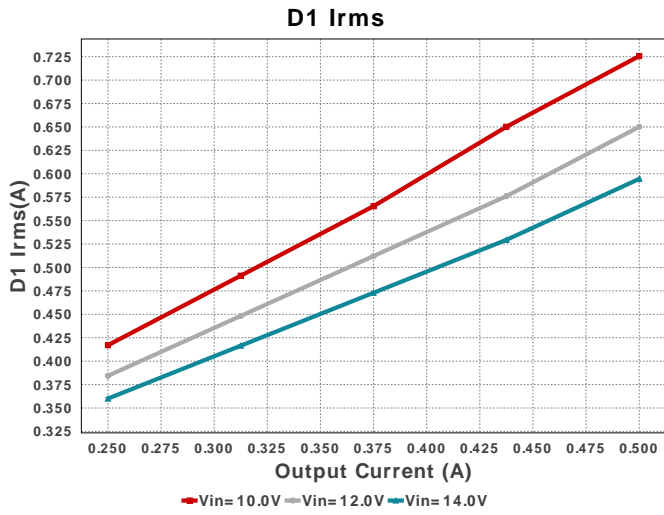



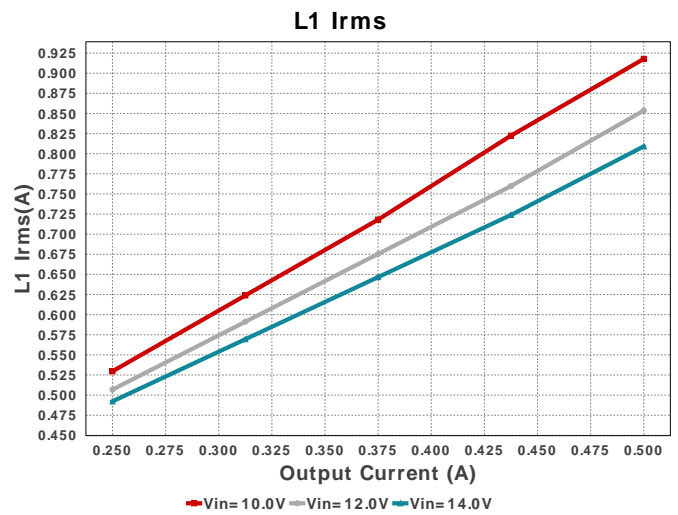
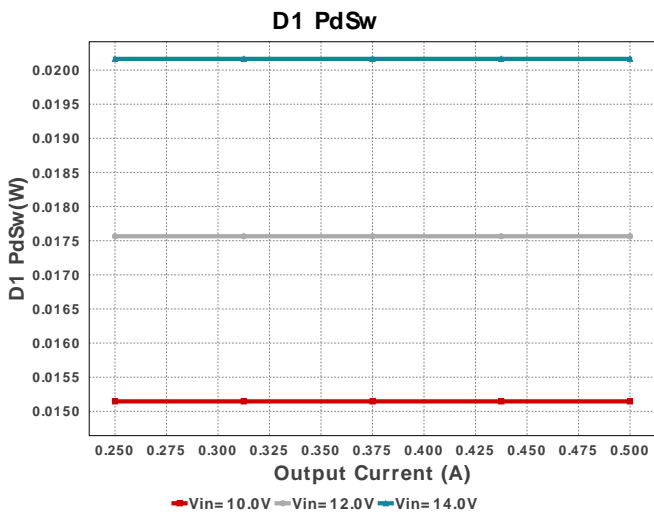
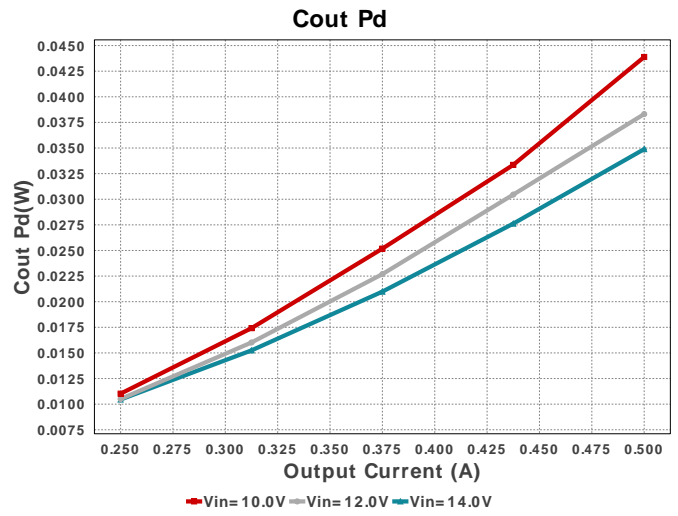
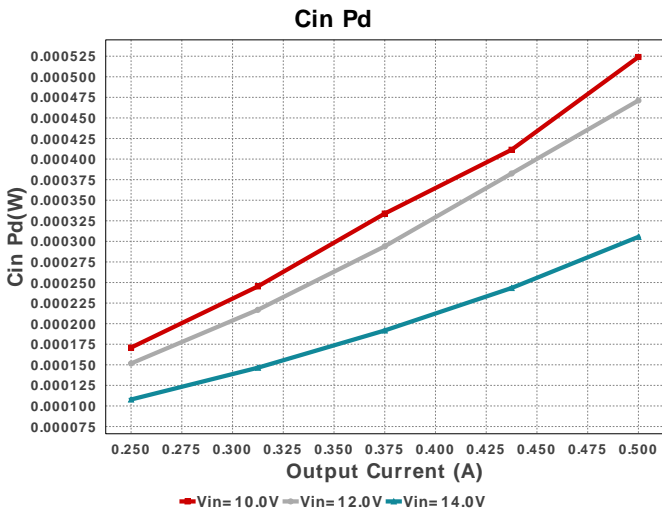
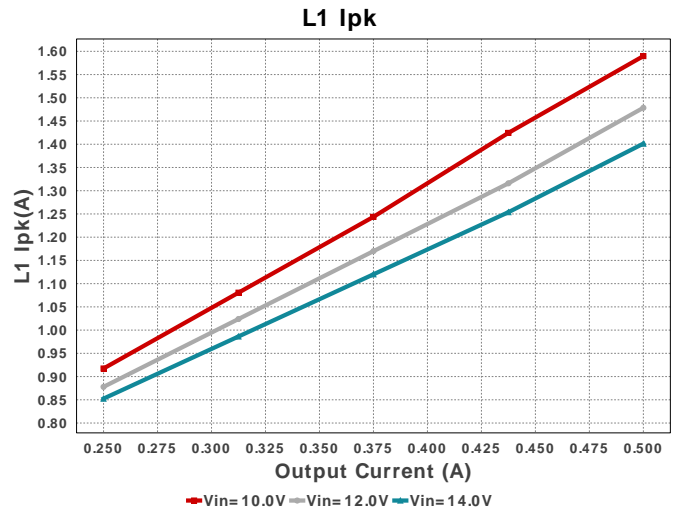
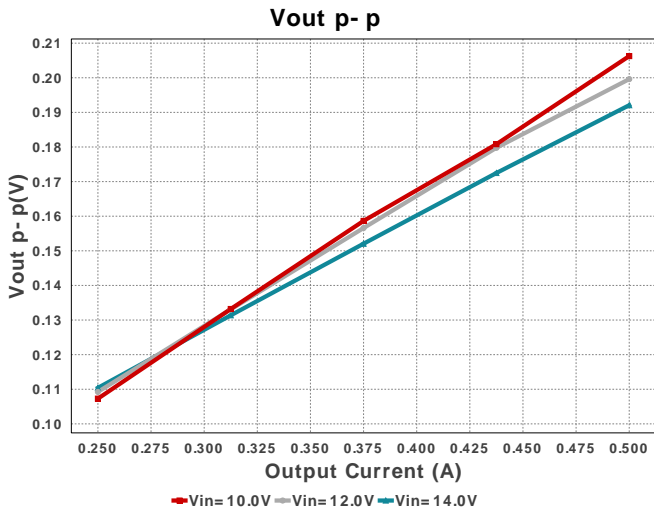

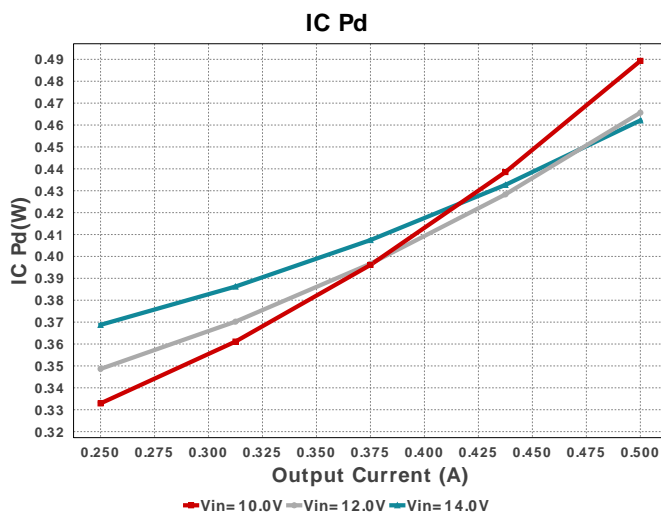
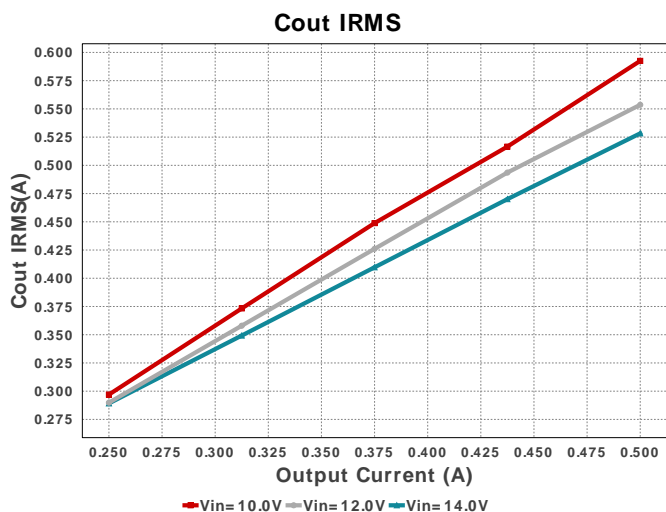
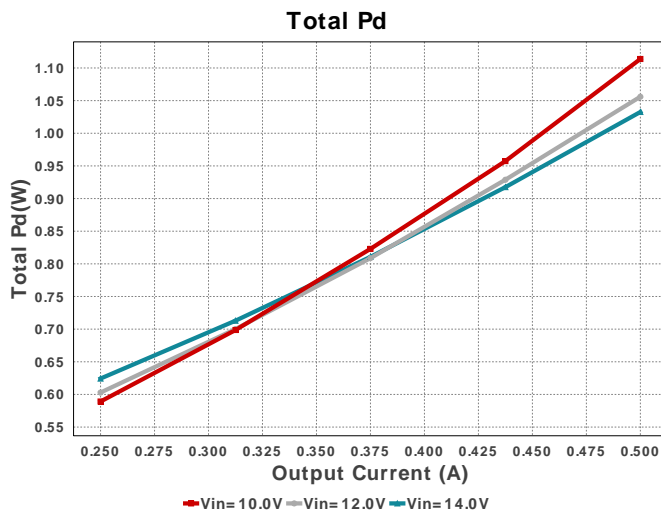
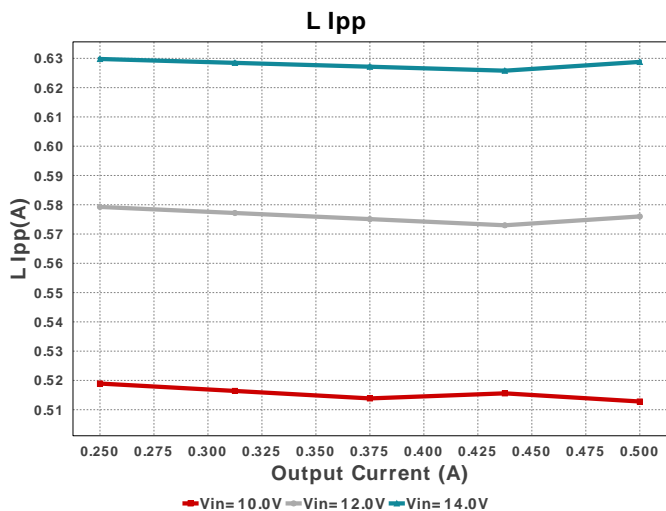
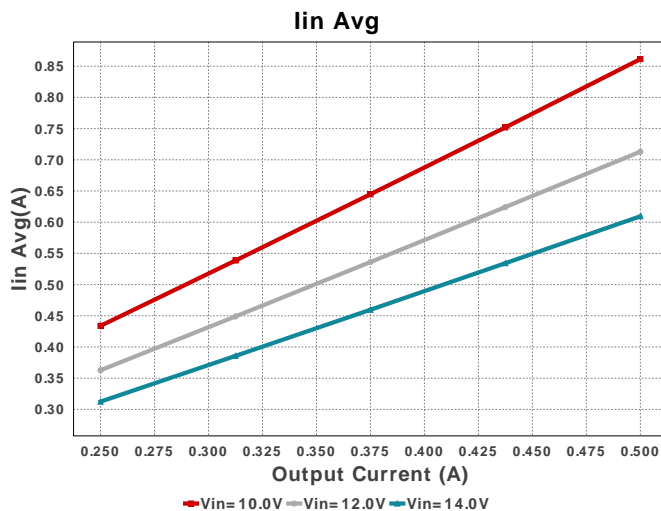
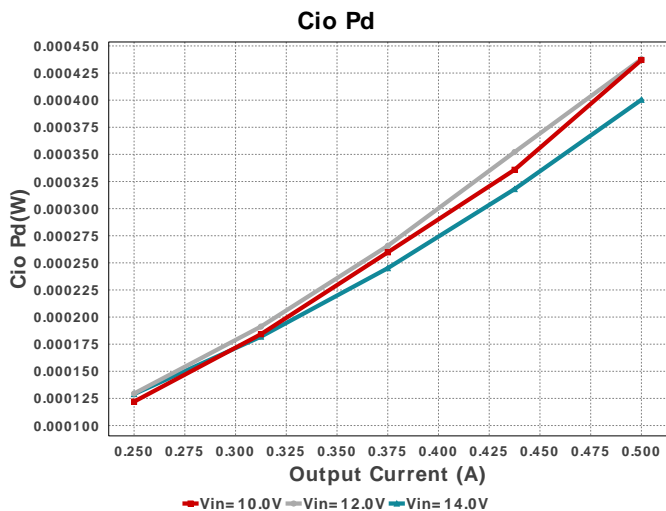

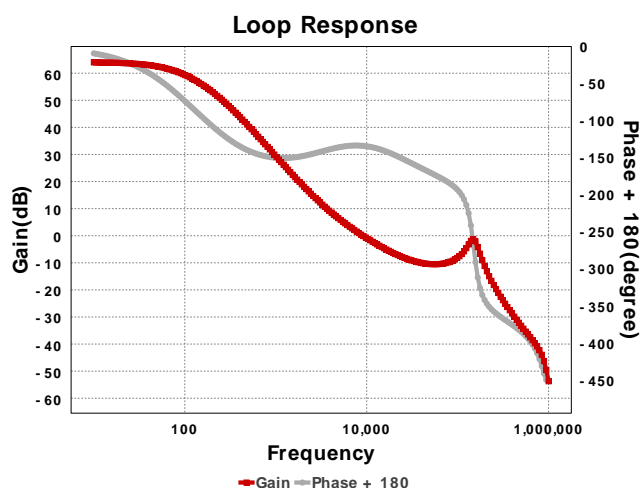

Operating Values

#	Name	Value	Category	Description
1.	Cin IRMS	318.118 mA	Capacitor	Input capacitor RMS ripple current
2.	Cin Pd	522.796 μ W	Capacitor	Input capacitor power dissipation
3.	Cio IRMS	281.749 mA	Capacitor	Input to output capacitor RMS ripple current
4.	Cio Pd	438.349 μ W	Capacitor	Input to output capacitor power dissipation
5.	Cout IRMS	592.16 mA	Capacitor	Output capacitor RMS ripple current
6.	Cout Pd	43.832 mW	Capacitor	Output capacitor power dissipation
7.	D1 Irms	725.116 mA	Current	D1 Irms
8.	D1 Pd	365.21 mW	Diode	Diode power dissipation
9.	D1 PdCond	350.0 mW	Diode	Diode conduction losses
10.	D1 PdSw	15.21 mW	Diode	Diode switching losses
11.	D1 Tj	51.913 degC	Diode	D1 junction temperature
12.	IC Ipk	6.35 mA	IC	Peak switch current in IC
13.	IC Pd	489.731 mW	IC	IC power dissipation
14.	IC Tj	49.589 degC	IC	IC junction temperature
15.	IC Tolerance	18.0 mV	IC	IC Feedback Tolerance
16.	Iin Avg	861.4 mA	IC	Average input current
17.	L Ipp	510.634 mA	Inductor	Peak-to-peak output inductor ripple current
18.	L Pd	135.009 mW	Inductor	Inductor power dissipation
19.	L1 Ipk	1.589 A	Inductor	Inductor peak current
20.	L1 Irms	917.208 mA	Inductor	Inductor ripple current
21.	IOUT_OP	500.0 mA	Op Point	Iout operating point
22.	VIN_OP	10.0 V	Op Point	Vin operating point
23.	Total Pd	1.114 W	Power	Total Power Dissipation
24.	Rsense Pd	66.465 mW	Resistor	LED Current Rsns Power Dissipation
25.	BOM Count	21	System	Total Design BOM count
26.	Cross Freq	8.704 kHz	System	Bode plot crossover frequency
27.	Duty Cycle	62.5 %	System	Duty cycle
28.	Efficiency	87.068 %	System	Steady state efficiency
29.	FootPrint	514.0 mm ²	System	Total Foot Print Area of BOM components
30.	Frequency	300.0 kHz	System	Switching frequency
31.	Gain Marg	10.082 db	System	Bode Plot Gain Margin
32.	Mode	DCM	System	Conduction Mode
33.	Phase Marg	46.498 deg	System	Bode Plot Phase Margin
34.	Phase Shift	29.807 deg	System	Bode Plot Phase Shift
35.	Total BOM	\$4.39	System	Total BOM Cost
36.	Vin p-p	112.154 mV	System	Peak-to-peak input voltage
37.	Vout p-p	206.148 mV	System	Peak-to-peak output ripple voltage

Design Inputs

Name	Value	Description
Iout	500.0 m	Maximum Output Current
VinMax	14.0	Maximum input voltage
VinMin	10.0	Minimum input voltage
VinTyp	12.0	Typical input voltage
Vout	-15.0	Output Voltage
base_pn	LM25005	Base Product Number
source	DC	Input Source Type
Ta	30.0	Ambient temperature

WEBENCH® Assembly

Component Testing

Some published data on components in datasheets such as Capacitor ESR and Inductor DC resistance is based on conservative values that will guarantee that the components always exceed the specification. For design purposes it is usually better to work with typical values. Since this data is not always available it is a good practice to measure the Capacitance and ESR values of C_{in} and C_{out} , and the inductance and DC resistance of $L1$ before assembly of the board. Any large discrepancies in values should be electrically simulated in WEBENCH to check for instabilities and thermally simulated in WebTHERM to make sure critical temperatures are not exceeded.

Soldering Component to Board

If board assembly is done in house it is best to tack down one terminal of a component on the board then solder the other terminal. For surface mount parts with large tabs, such as the DPAK, the tab on the back of the package should be pre-tinned with solder, then tacked into place by one of the pins. To solder the tab down to the board place the iron down on the board while resting against the tab, heating both surfaces simultaneously. Apply light pressure to the top of the plastic case until the solder flows around the part and the part is flush with the PCB. If the solder is not flowing around the board you may need a higher wattage iron (generally 25W to 30W is enough).

Initial Startup of Circuit

It is best to initially power up the board by setting the input supply voltage to the lowest operating input voltage 10.0V and set the input supply's current limit to zero. With the input supply off connect up the input supply to V_{in} and GND. Connect a digital volt meter and a load if needed to set the minimum load of the design from V_{out} and GND. Turn on the input supply and slowly turn up the current limit on the input supply. If the voltage starts to rise on the input supply continue increasing the input supply current limit while watching the output voltage. If the current increases on the input supply, but the voltage remains near zero, then there may be a short or a component misplaced on the board. Power down the board and visually inspect for solder bridges and recheck the diode and capacitor polarities. Once the power supply circuit is operational then more extensive testing may include full load testing, transient load and line tests to compare with simulation results.

Load Testing

The setup is the same as the initial startup, except that an additional digital voltmeter is connected between V_{in} and GND, a load is connected between V_{out} and GND and a current meter is connected in series between V_{out} and the load. The load must be able to handle at least rated output power + 50% (7.5 watts for this design). Ideally the load is supplied in the form of a variable load test unit. It can also be done in the form of suitably large power resistors. When using an oscilloscope to measure waveforms on the prototype board, the ground leads of the oscilloscope probes should be as short as possible and the area of the loop formed by the ground lead should be kept to a minimum. This will help reduce ground lead inductance and eliminate EMI noise that is not actually present in the circuit.



Design Assistance

1. Master key : 3378A689E7B2C141[v1]
2. **LM25005** Product Folder : <http://www.ti.com/product/LM25005> : contains the data sheet and other resources.

Important Notice and Disclaimer

TI provides technical and reliability data (including datasheets), design resources (including reference designs), application or other design advice, web tools, safety information, and other resources AS IS and with all faults, and disclaims all warranties. These resources are intended for skilled developers designing with TI products. You are solely responsible for (1) selecting the appropriate TI products for your application, (2) designing, validating and testing your application, and (3) ensuring your application meets applicable standards, and any other safety, security, or other requirements.

These resources are subject to change without notice. TI grants you permission to use these resources only for development of an application that uses the TI products described in the resource. Other reproduction and display of these resources is prohibited. No license is granted to any other TI intellectual property right or to any third party intellectual property right. TI disclaims responsibility for, and you will fully indemnify TI and its representatives against, any claims, damages, costs, losses, and liabilities arising out of your use of these resources.

Providing these resources does not expand or otherwise alter TI's applicable Terms of Sale or other applicable terms available either on ti.com or provided in conjunction with TI products.