

A

B

C

D

A

B

C

D

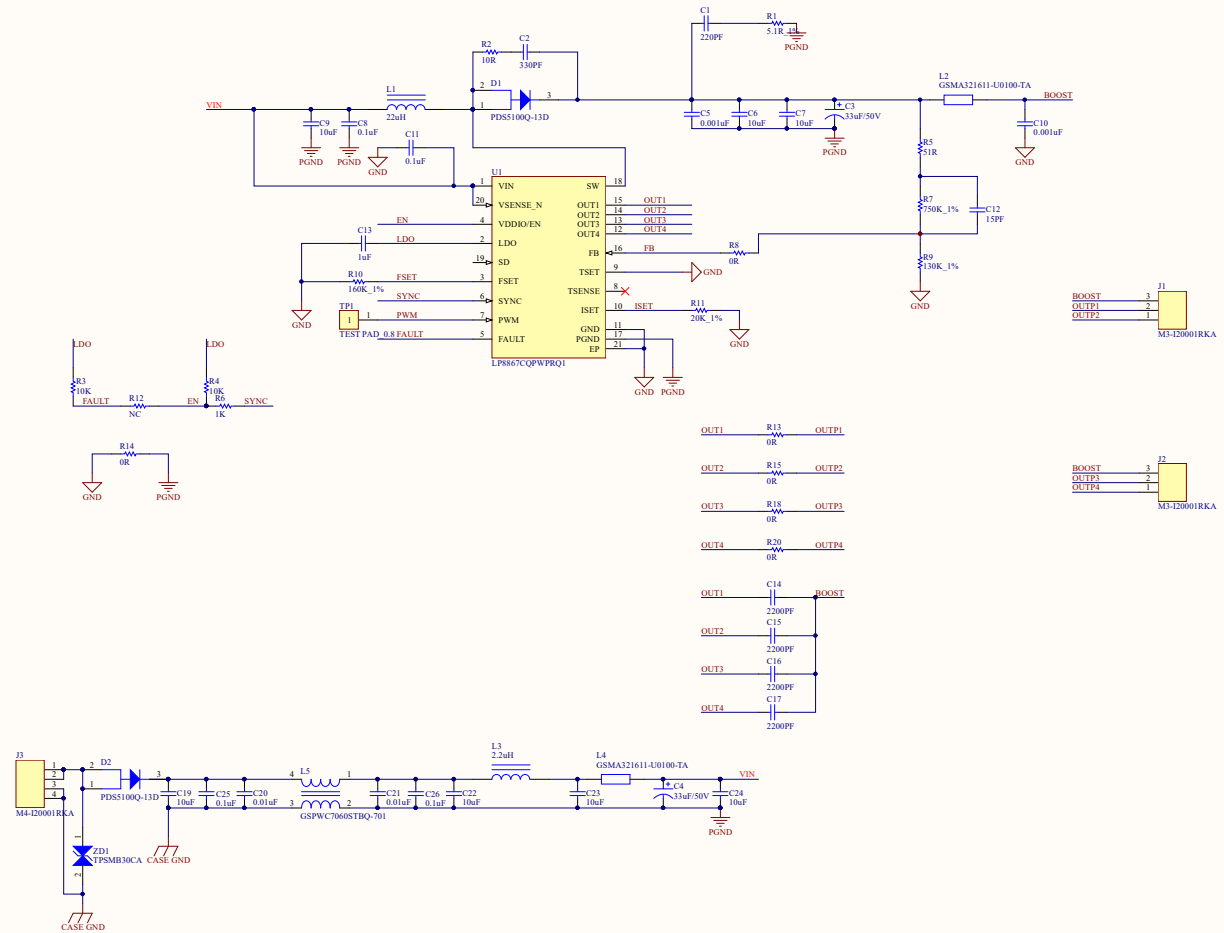

Title		
Size	Number	Revision
A2		
Date:	2019/12/24	Sheet of
File: D:\Album Design\10.DATA\SC1_V110268.Dwg		

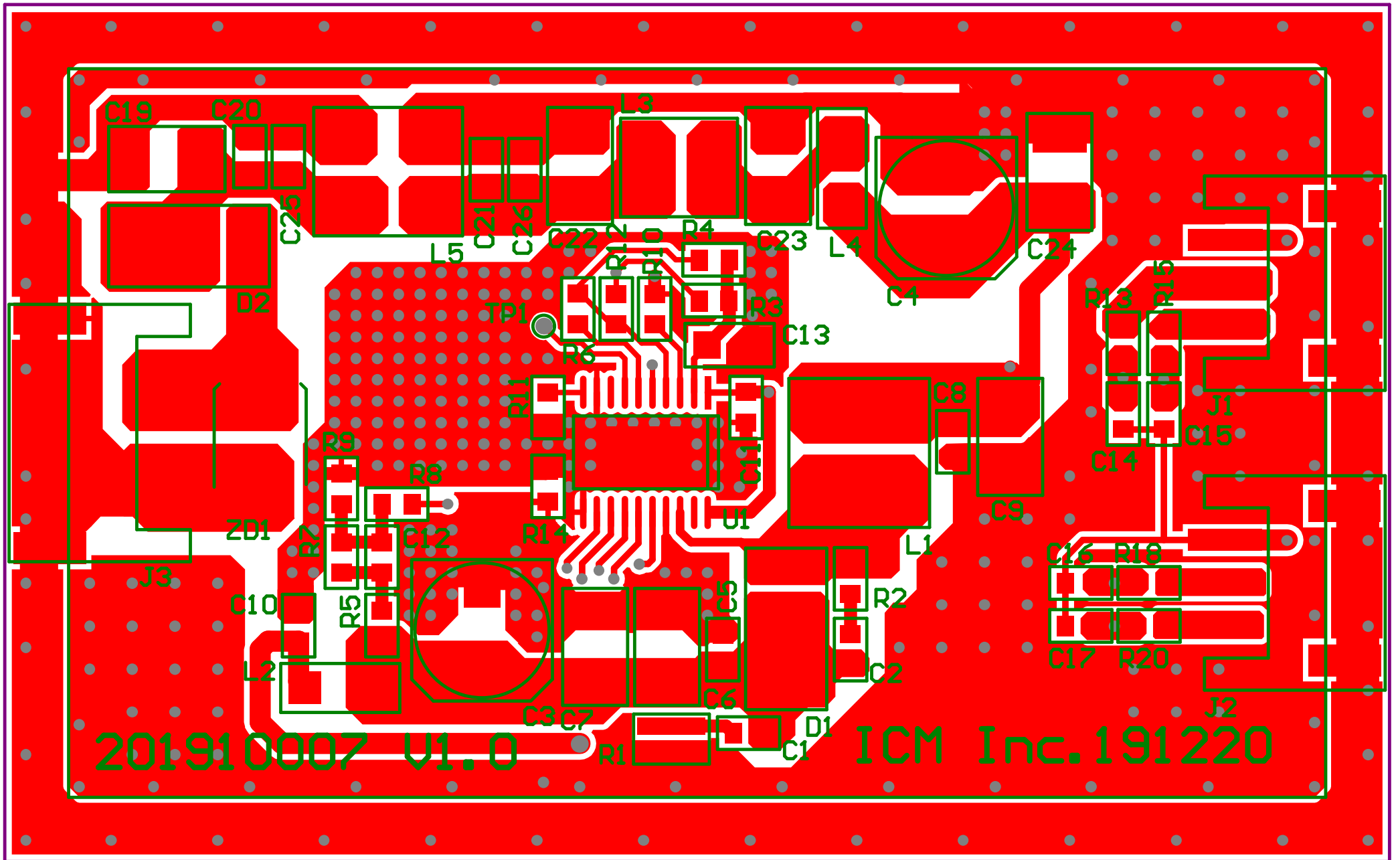

FR-4 1oz 1.6t  
SIZE: (65.0mm\*40.0mm)

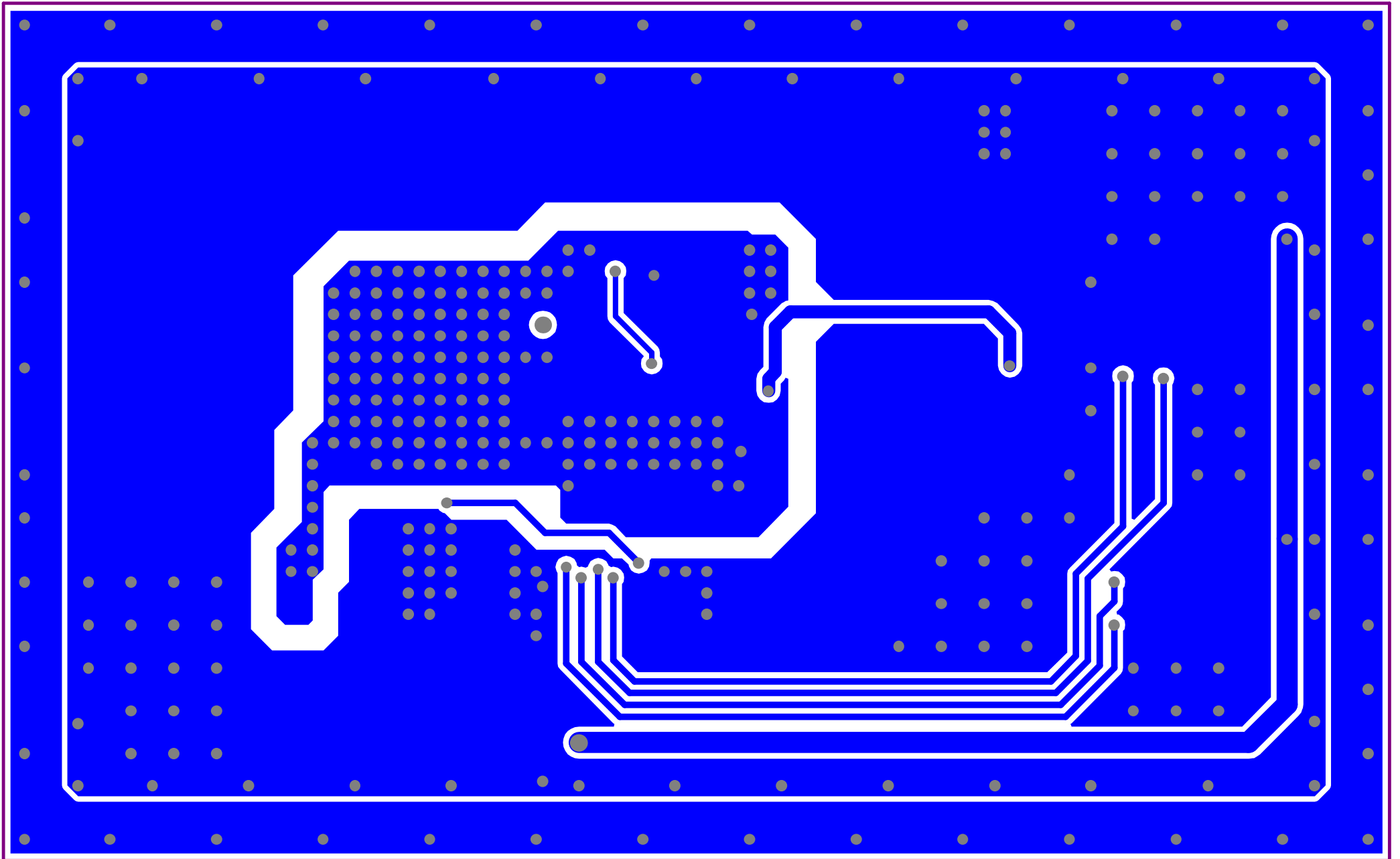

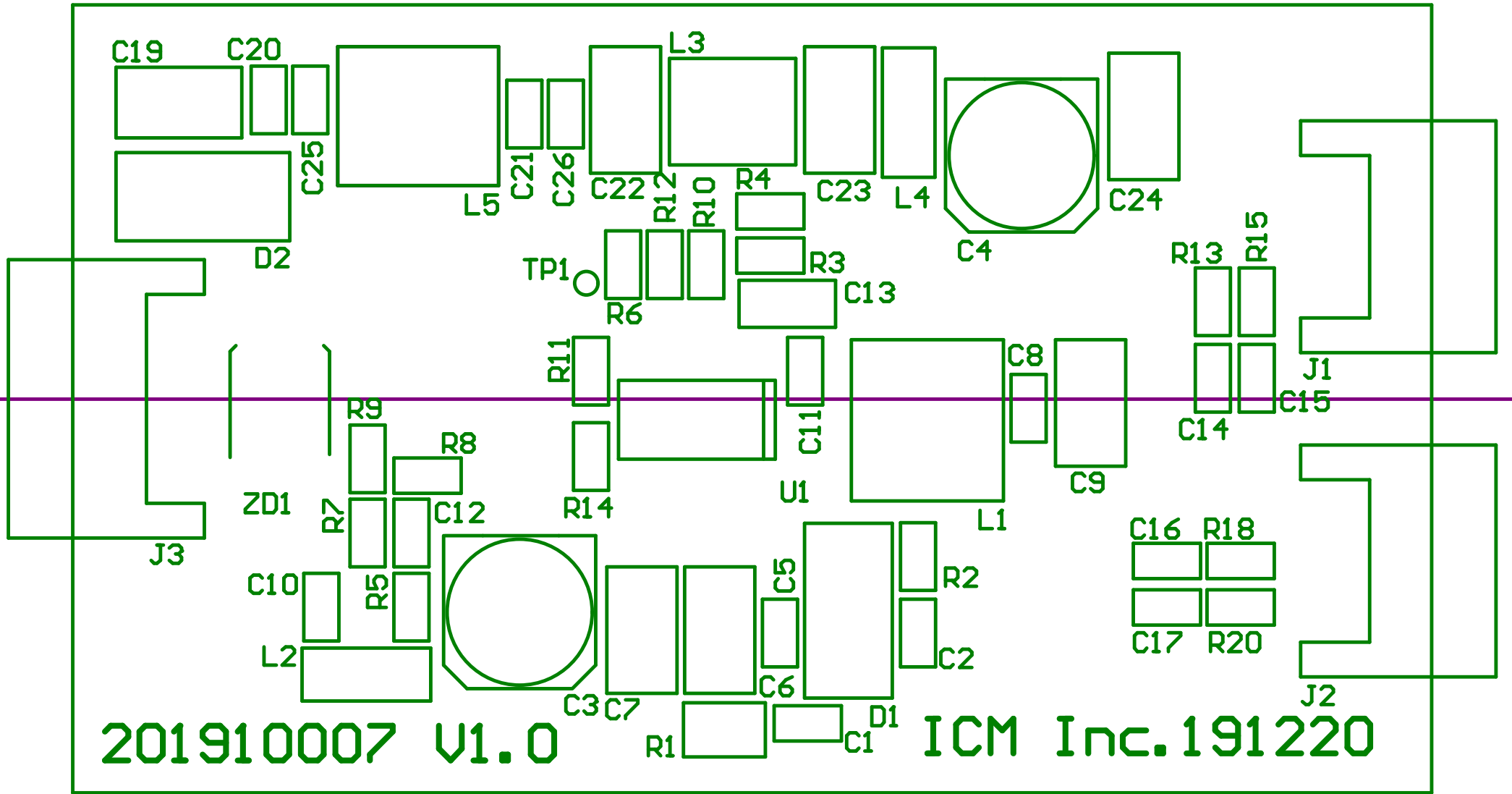

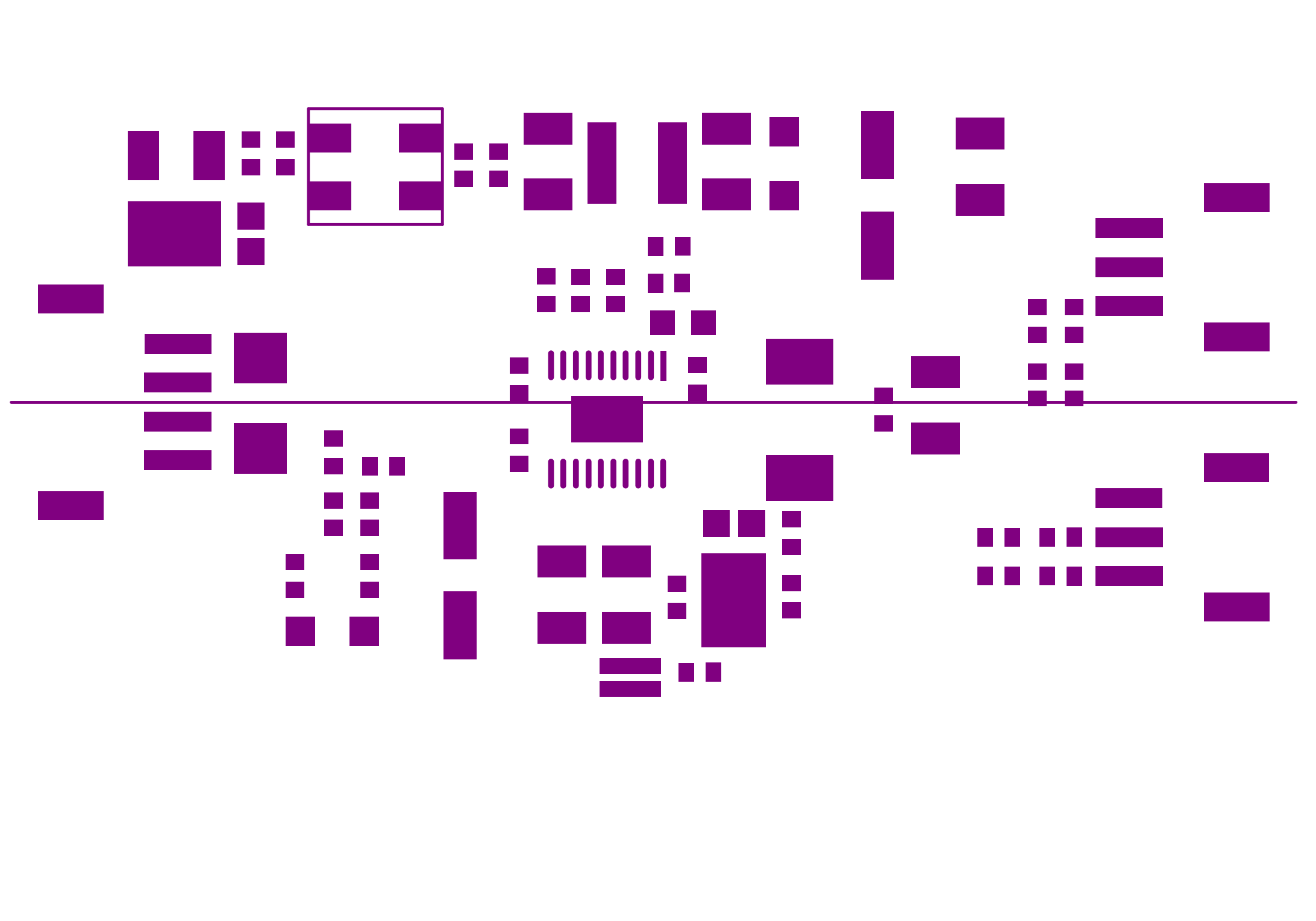

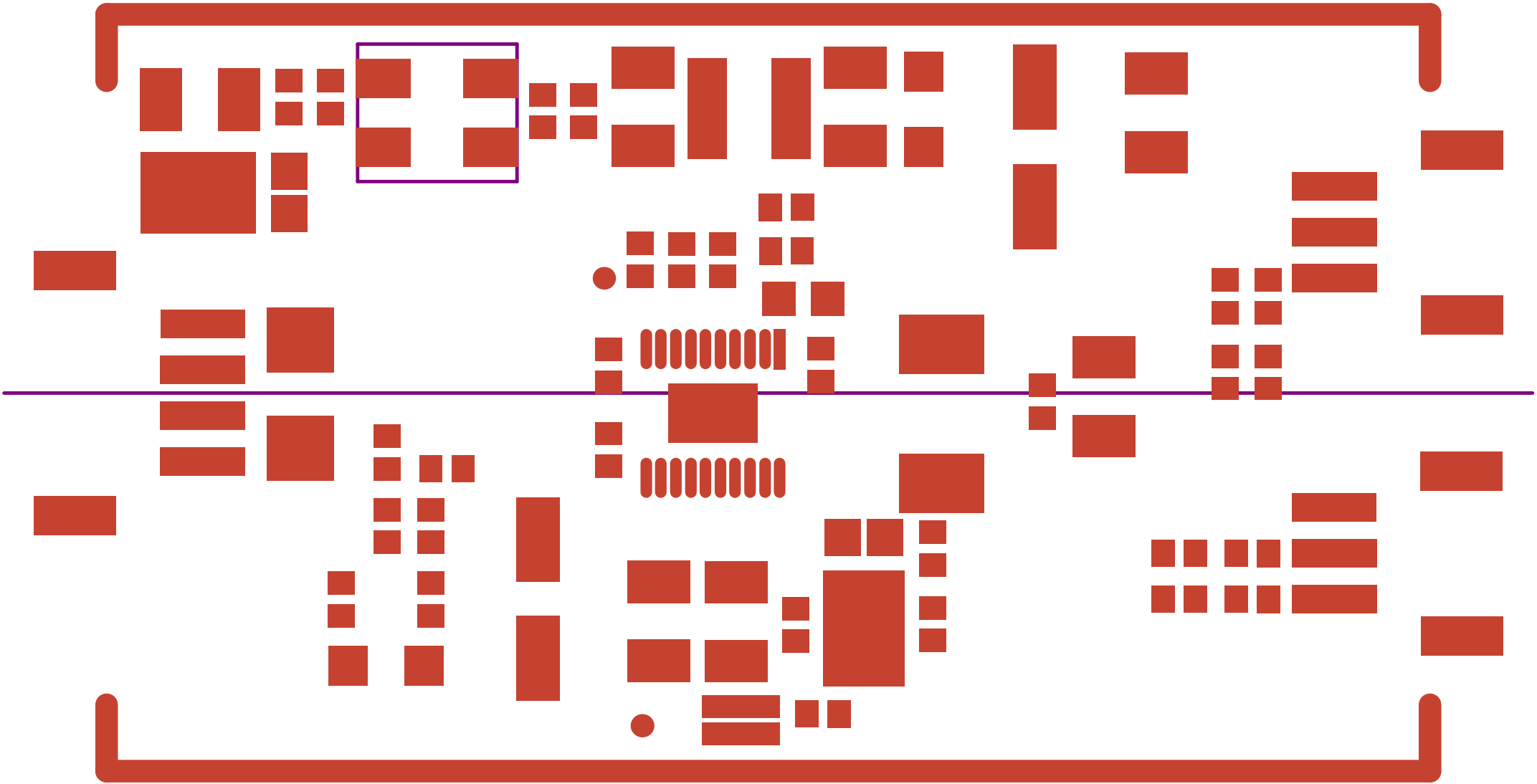







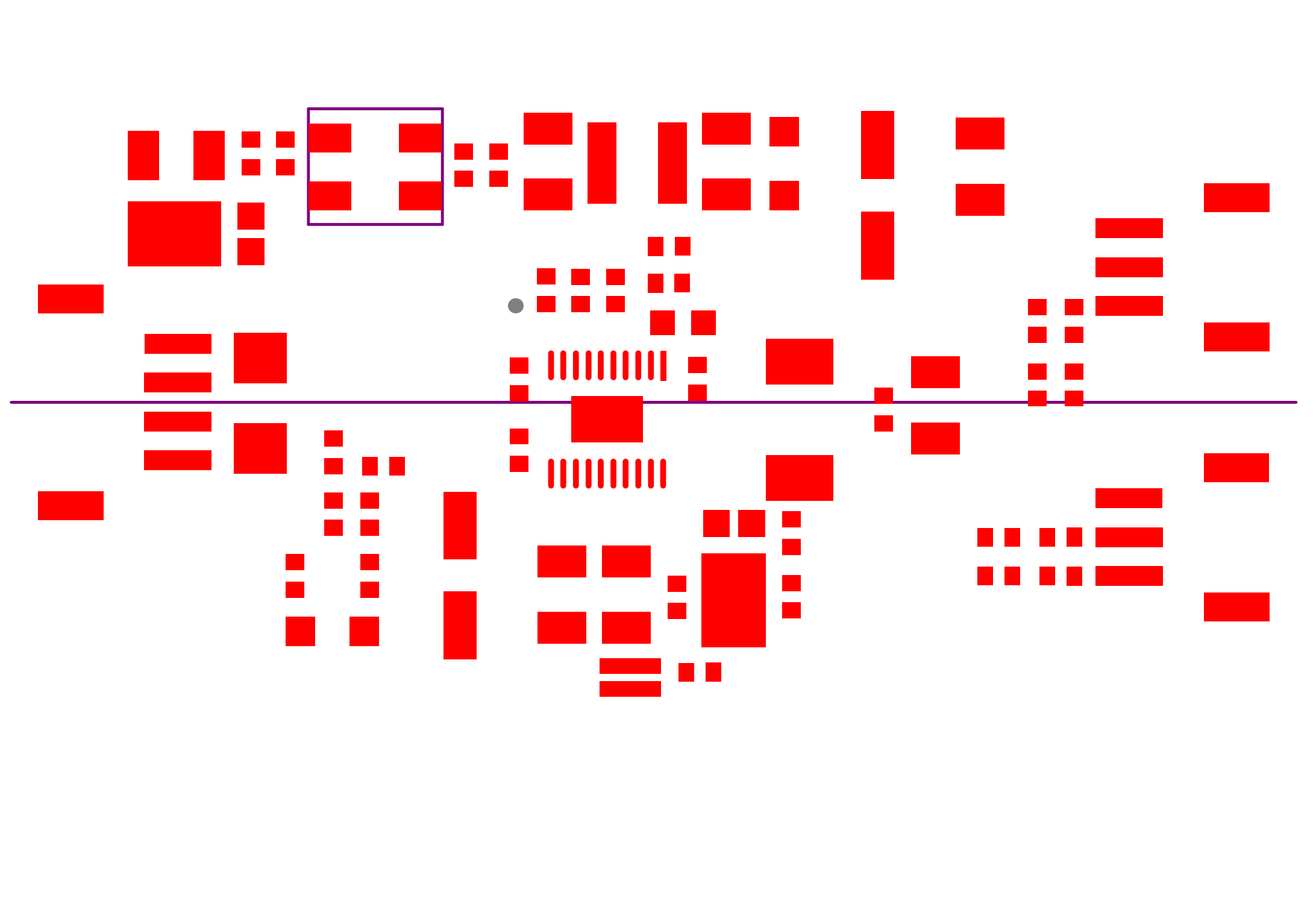





FR-4 1oz 1.6t  
SIZE: (65.0mm\*40.0mm)

