

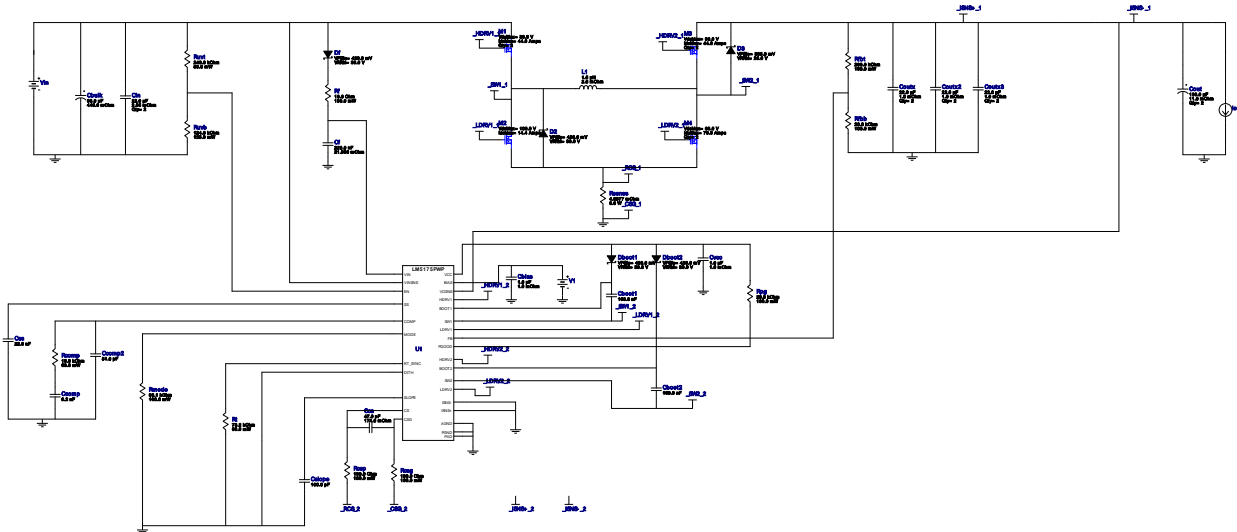













WEBENCH[®] Design Report

 Design : LM5175PWPR
 LM5175PWPR 4V-18V to 12.00V @ 6A

Electrical BOM

#	Name	Manufacturer	Part Number	Properties	Qty	Price	Footprint
1.	Cbias	Taiyo Yuden	TMK212BJ105KG-T Series= X5R	Cap= 1.0 uF ESR= 1.0 mOhm VDC= 25.0 V IRMS= 0.0 A	1	\$0.03	0805 7 mm ²
2.	Cboot1	AVX	08053C104JAZ2A Series= X7R	Cap= 100.0 nF VDC= 25.0 V IRMS= 0.0 A	1	\$0.10	0805 7 mm ²
3.	Cboot2	AVX	08053C104JAZ2A Series= X7R	Cap= 100.0 nF VDC= 25.0 V IRMS= 0.0 A	1	\$0.10	0805 7 mm ²
4.	Cbulk	Nichicon	UUD1E680MCL1GS Series= uD	Cap= 68.0 uF ESR= 440.0 mOhm VDC= 25.0 V IRMS= 230.0 mA	1	\$0.11	 SM_RADIAL_6.3AMM 80 mm ²
5.	Ccomp	Samsung Electro-Mechanics	CL21C822JBFNNNE Series= C0G/NP0	Cap= 8.2 nF VDC= 50.0 V IRMS= 0.0 A	1	\$0.02	0805 7 mm ²
6.	Ccomp2	Samsung Electro-Mechanics	CL21C510JBANNNC Series= C0G/NP0	Cap= 51.0 pF VDC= 50.0 V IRMS= 0.0 A	1	\$0.01	0805 7 mm ²
7.	Ccs	AVX	06035A470JAT2A Series= C0G/NP0	Cap= 47.0 pF ESR= 174.0 mOhm VDC= 50.0 V IRMS= 0.0 A	1	\$0.01	0603 5 mm ²
8.	Cf	TDK	CGA3E3X7R1H224K080AB Series= X7R	Cap= 220.0 nF ESR= 21.699 mOhm VDC= 50.0 V IRMS= 1.125 A	1	\$0.04	0603 5 mm ²
9.	Cin	TDK	C2012X5R1V226M125AC Series= X5R	Cap= 22.0 uF ESR= 2.05 mOhm VDC= 35.0 V IRMS= 4.5559 A	2	\$0.38	0805 7 mm ²

#	Name	Manufacturer	Part Number	Properties	Qty	Price	Footprint
10.	Cout	Panasonic	16SVPE180M Series= SVPE	Cap= 180.0 uF ESR= 11.0 mOhm VDC= 16.0 V IRMS= 4.46 A	2	\$0.52	 CAPSMT_62_C10 74 mm ²
11.	Coutx	AVX	12103D226MAT2A Series= X5R	Cap= 22.0 uF ESR= 1.0 mOhm VDC= 25.0 V IRMS= 0.0 A	2	\$0.31	 1210 15 mm ²
12.	Coutx2	AVX	12103D226MAT2A Series= X5R	Cap= 22.0 uF ESR= 1.0 mOhm VDC= 25.0 V IRMS= 0.0 A	2	\$0.31	 1210 15 mm ²
13.	Coutx3	AVX	12103D226MAT2A Series= X5R	Cap= 22.0 uF ESR= 1.0 mOhm VDC= 25.0 V IRMS= 0.0 A	2	\$0.31	 1210 15 mm ²
14.	Cslope	Samsung Electro-Mechanics	CL10C101JB8NNNC Series= C0G/NP0	Cap= 100.0 pF VDC= 50.0 V IRMS= 0.0 A	1	\$0.01	 0603 5 mm ²
15.	Css	TDK	CGA4J2C0G1H223J125AA Series= C0G/NP0	Cap= 22.0 nF VDC= 50.0 V IRMS= 0.0 A	1	\$0.09	 0805 7 mm ²
16.	Cvcc	Taiyo Yuden	EMK107B7105KA-T Series= X7R	Cap= 1.0 uF ESR= 1.0 mOhm VDC= 16.0 V IRMS= 0.0 A	1	\$0.02	 0603 5 mm ²
17.	D2	International Rectifier	10BQ030TRPBF	VF@Io= 420.0 mV VRRM= 30.0 V	1	\$0.13	 SMB 44 mm ²
18.	D3	Comchip Technology	CDBK0520L-HF	VF@Io= 385.0 mV VRRM= 20.0 V	1	\$0.08	 SOD-123F 12 mm ²
19.	Dboot1	International Rectifier	10BQ030TRPBF	VF@Io= 420.0 mV VRRM= 30.0 V	1	\$0.13	 SMB 44 mm ²
20.	Dboot2	International Rectifier	10BQ030TRPBF	VF@Io= 420.0 mV VRRM= 30.0 V	1	\$0.13	 SMB 44 mm ²
21.	Df	International Rectifier	10BQ030TRPBF	VF@Io= 420.0 mV VRRM= 30.0 V	1	\$0.13	 SMB 44 mm ²
22.	L1	Bourns	SRP1270-1R5M	L= 1.5 uH DCR= 2.6 mOhm	1	\$0.72	 SRP1270 246 mm ²
23.	M1	Texas Instruments	CSD17571Q2	VdsMax= 30.0 V IdsMax= 44.0 Amps	2	\$0.13	DQK0006C 9 mm ²
24.	M2	Texas Instruments	CSD19538Q2	VdsMax= 100.0 V IdsMax= 14.4 Amps	1	\$0.21	DQK0006C 9 mm ²
25.	M3	Texas Instruments	CSD17571Q2	VdsMax= 30.0 V IdsMax= 44.0 Amps	2	\$0.13	DQK0006C 9 mm ²
26.	M4	Texas Instruments	CSD18543Q3A	VdsMax= 60.0 V IdsMax= 70.0 Amps	2	\$0.27	 DNH0008A 18 mm ²
27.	Rcomp	Vishay-Dale	CRCW040216K9FKED Series= CRCW..e3	Res= 16900.0Ohm Power= 63.0 mW Tolerance= 1.0%	1	\$0.01	 0402 3 mm ²
28.	Rcsg	Vishay-Dale	CRCW0603100RFKEA Series= CRCW..e3	Res= 100.0Ohm Power= 100.0 mW Tolerance= 1.0%	1	\$0.01	 0603 5 mm ²

#	Name	Manufacturer	Part Number	Properties	Qty	Price	Footprint
29.	Rcsp	Vishay-Dale	CRCW0603100RFKEA Series= CRCW..e3	Res= 100.0Ohm Power= 100.0 mW Tolerance= 1.0%	1	\$0.01	■ 0603 5 mm ²
30.	Rf	Vishay-Dale	CRCW060310R0FKEA Series= CRCW..e3	Res= 10.0Ohm Power= 100.0 mW Tolerance= 1.0%	1	\$0.01	■ 0603 5 mm ²
31.	Rfbb	Yageo	RC0603FR-0720KL Series= ?	Res= 20000.0Ohm Power= 100.0 mW Tolerance= 1.0%	1	\$0.01	■ 0603 5 mm ²
32.	Rfbt	Yageo	RC0603FR-07280KL Series= ?	Res= 280000.0Ohm Power= 100.0 mW Tolerance= 1.0%	1	\$0.01	■ 0603 5 mm ²
33.	Rmode	Vishay-Dale	CRCW060393K1FKEA Series= CRCW..e3	Res= 93100.0Ohm Power= 100.0 mW Tolerance= 1.0%	1	\$0.01	■ 0603 5 mm ²
34.	Rpg	Yageo	RC0603FR-0720KL Series= ?	Res= 20000.0Ohm Power= 100.0 mW Tolerance= 1.0%	1	\$0.01	■ 0603 5 mm ²
35.	Rsense	CUSTOM	CUSTOM Series= ?	Res= 0.0048577171109200346Ohm Power= 0.0 W Tolerance= 0.0%	1	NA	CUSTOM 0 mm ²
36.	Rt	Vishay-Dale	CRCW040273K2FKED Series= CRCW..e3	Res= 73200.0Ohm Power= 63.0 mW Tolerance= 1.0%	1	\$0.01	■ 0402 3 mm ²
37.	Ruvb	Panasonic	ERJ-6ENF1243V Series= ERJ-6E	Res= 124000.0Ohm Power= 125.0 mW Tolerance= 1.0%	1	\$0.01	■ 0805 7 mm ²
38.	Ruvt	Yageo	RC0201FR-07249KL Series= ?	Res= 249000.0Ohm Power= 50.0 mW Tolerance= 1.0%	1	\$0.01	■ 0201 2 mm ²
39.	U1	Texas Instruments	LM5175PWPR	Switcher	1	\$3.10	 PWP0028F_N 98 mm ²

M3 ThetaJA

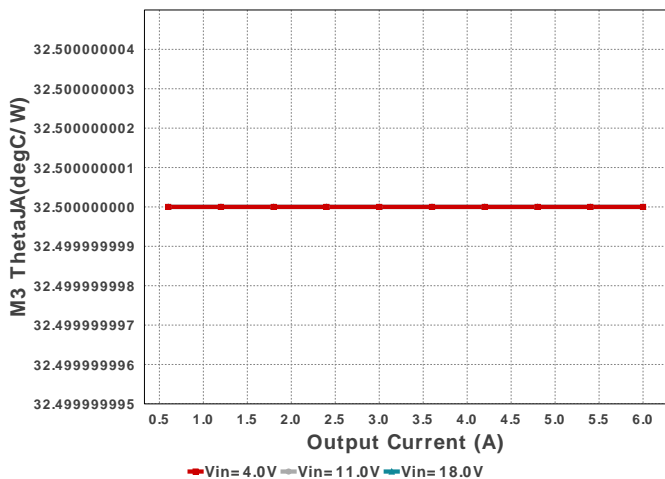

SW Ipk

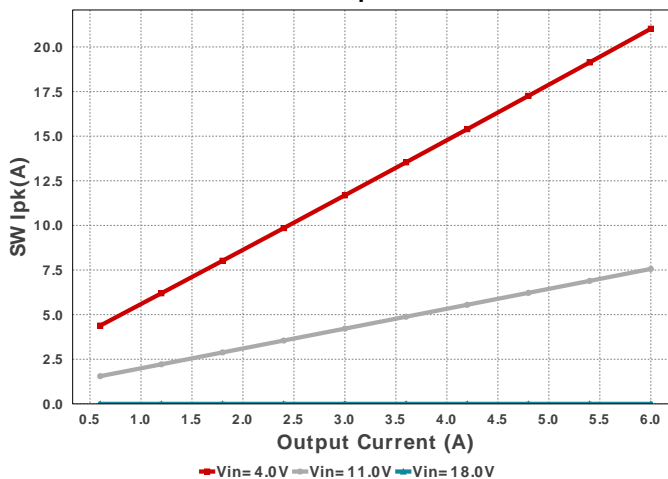

D2 Pd

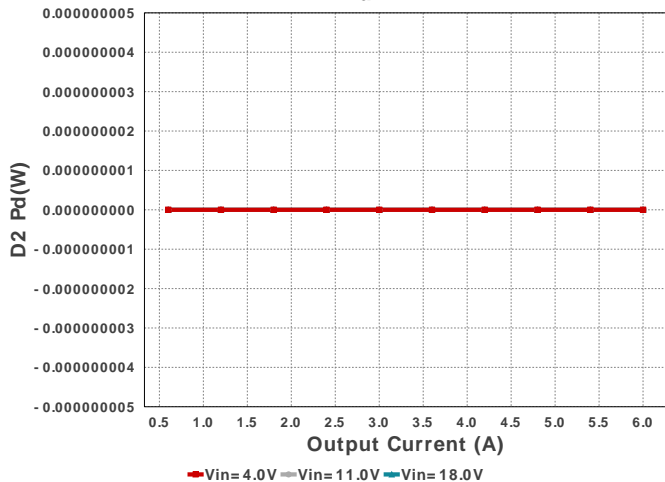

Rsense Pd

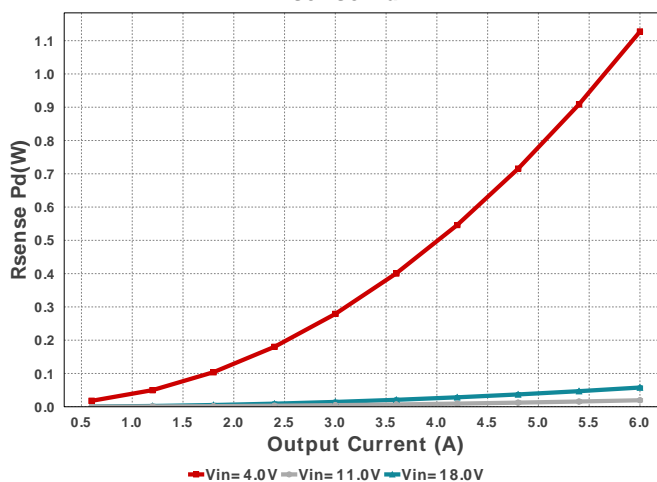

Cout IRMS

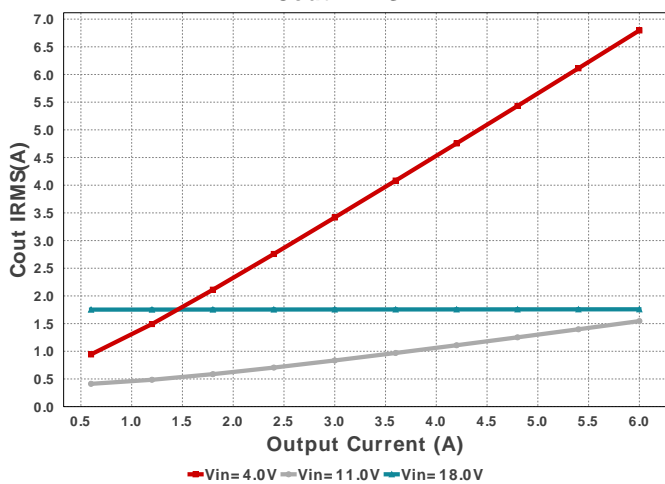

Cin Pd

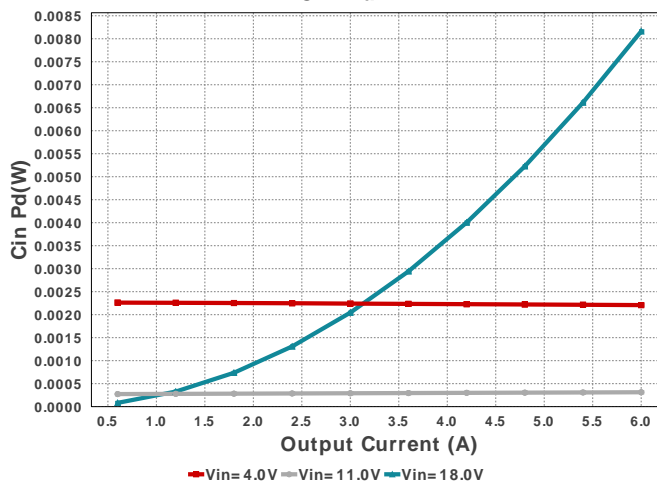

M2 PdSw

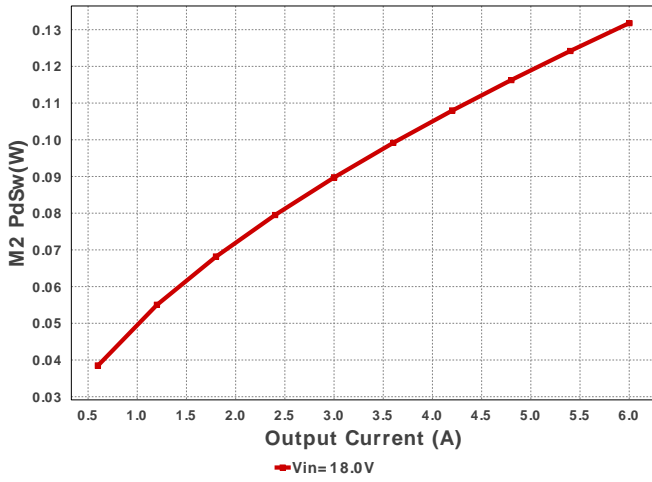

M1 ThetaJA

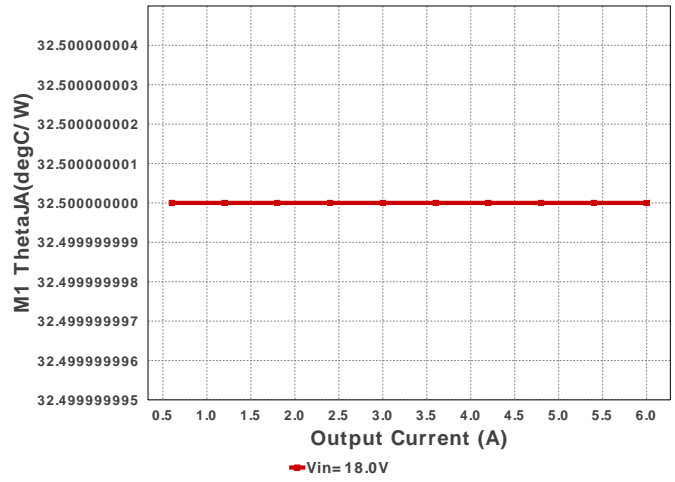

L Ipp

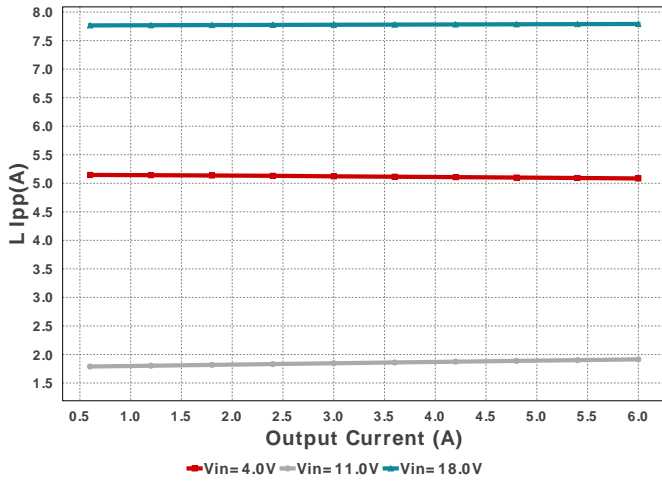

M1 Pd

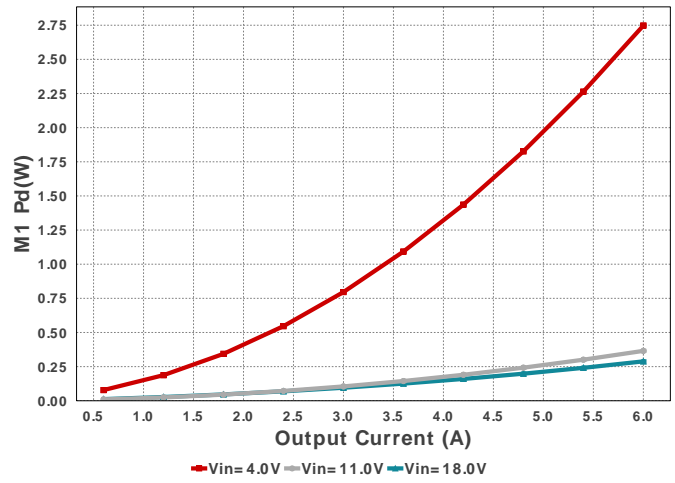

M4 PdSw

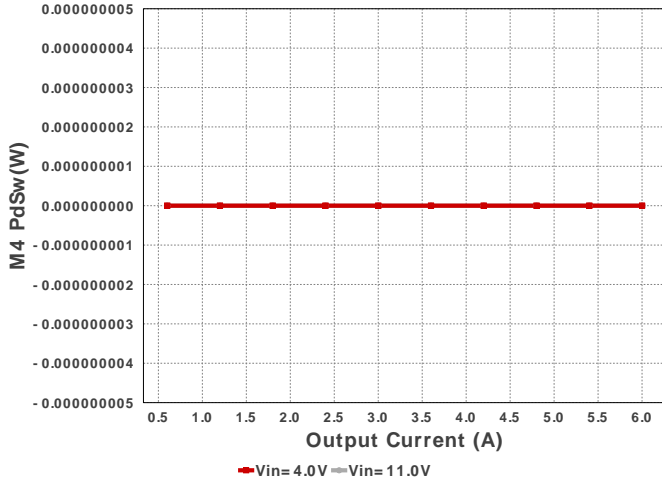

Cout Pd

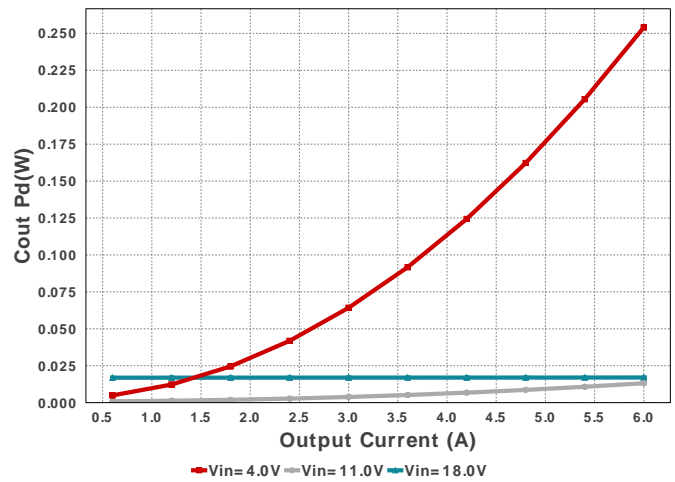

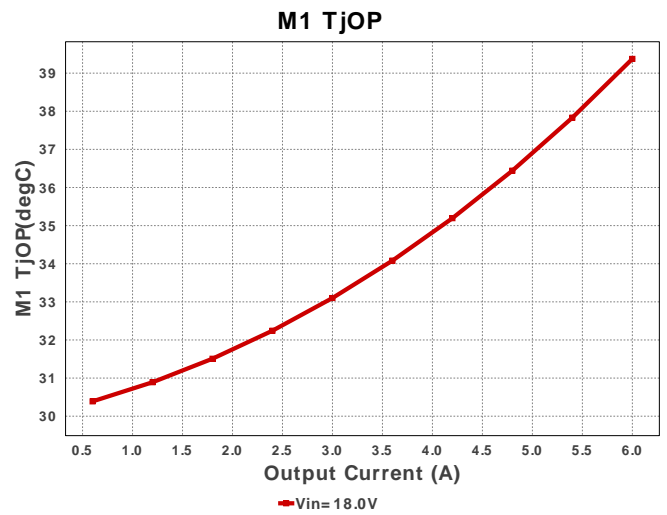
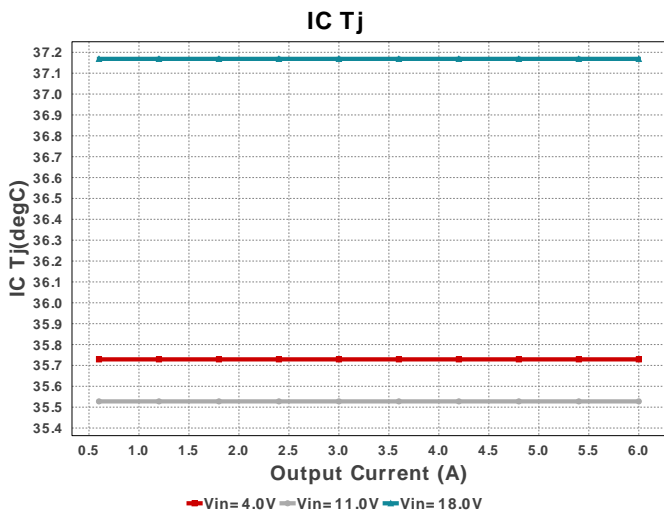
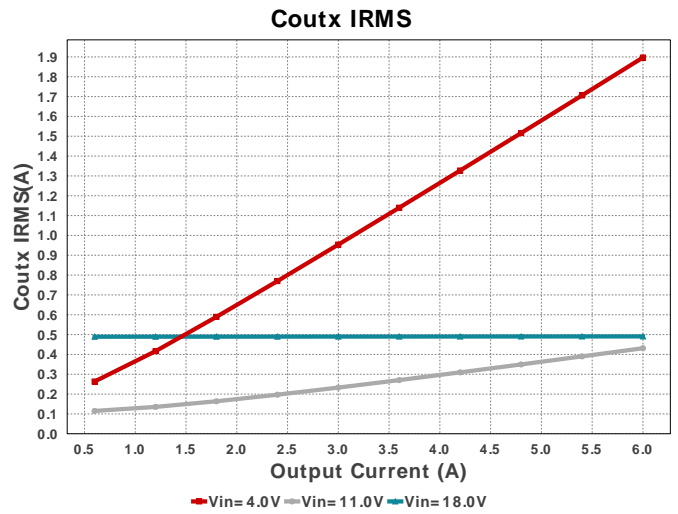
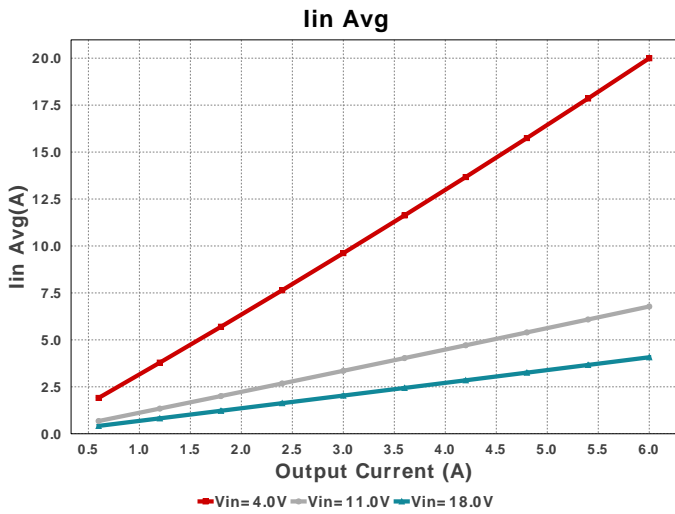
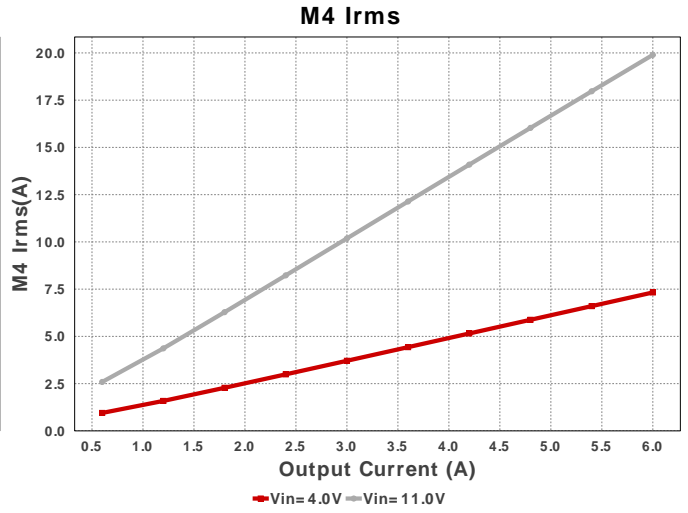
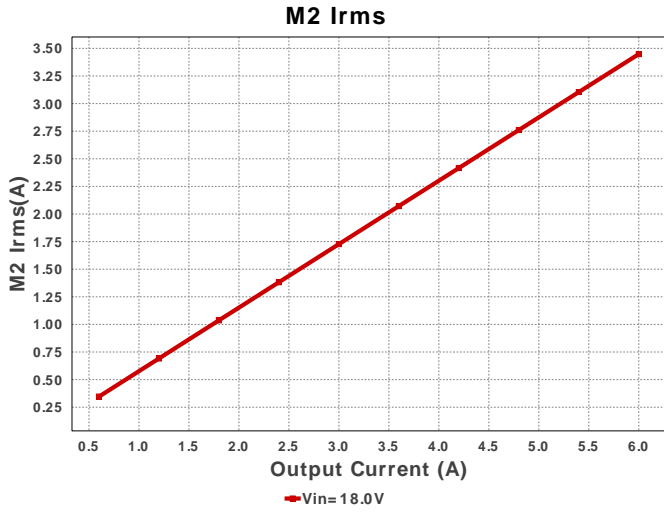

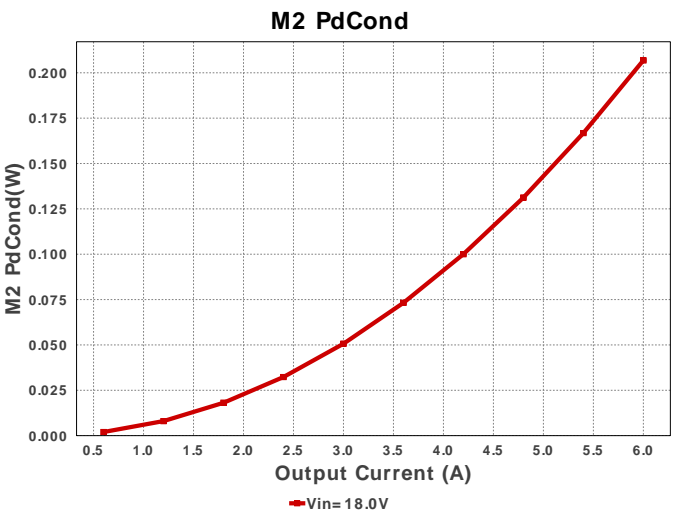
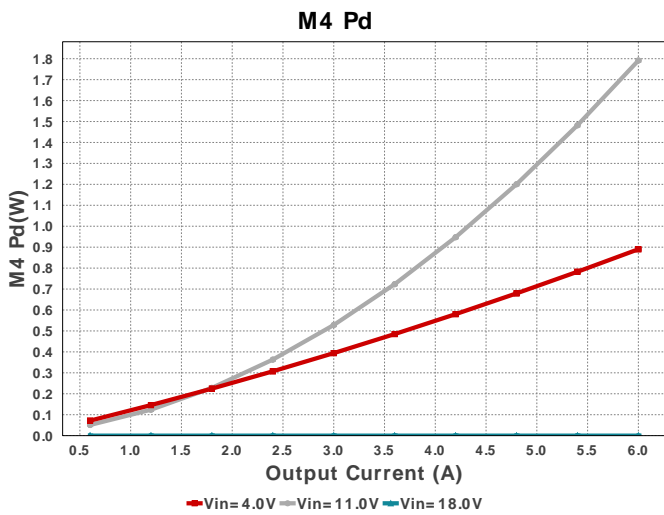
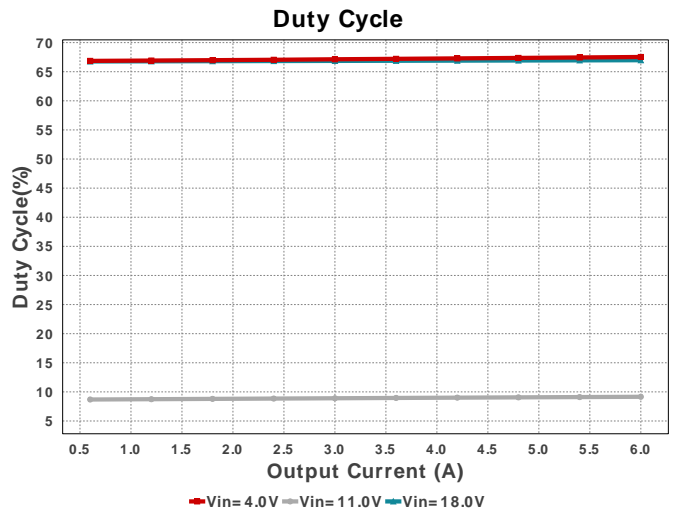
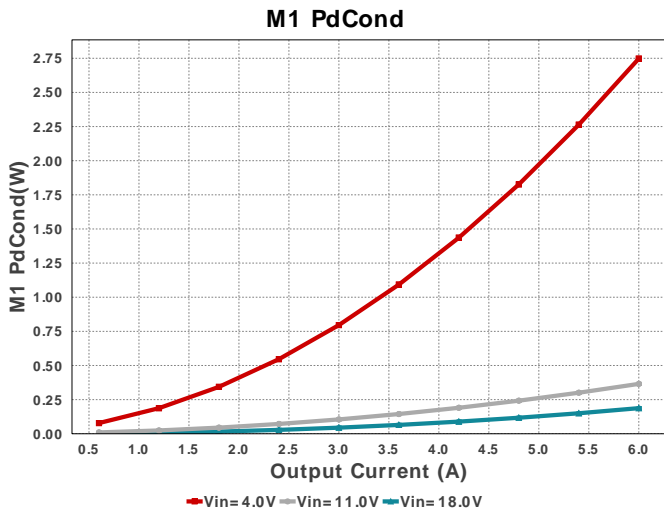
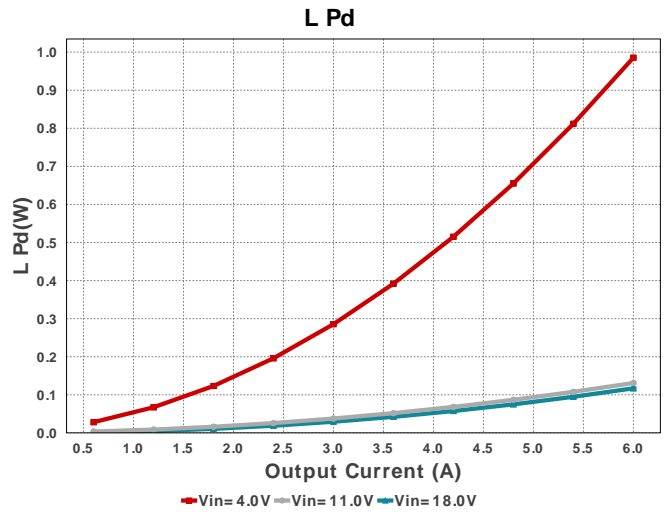
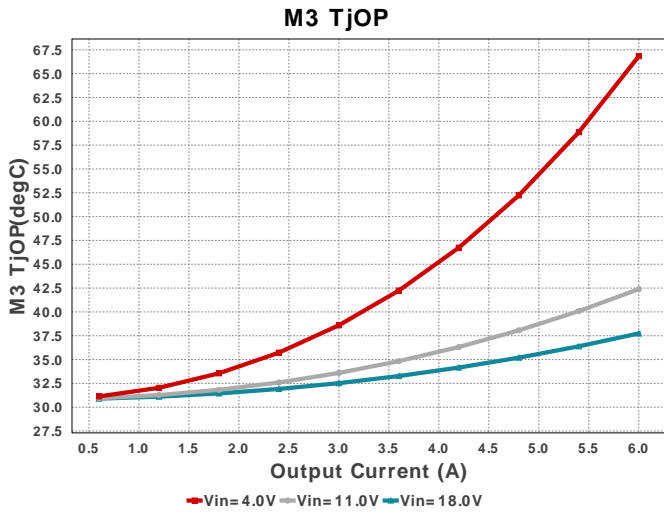

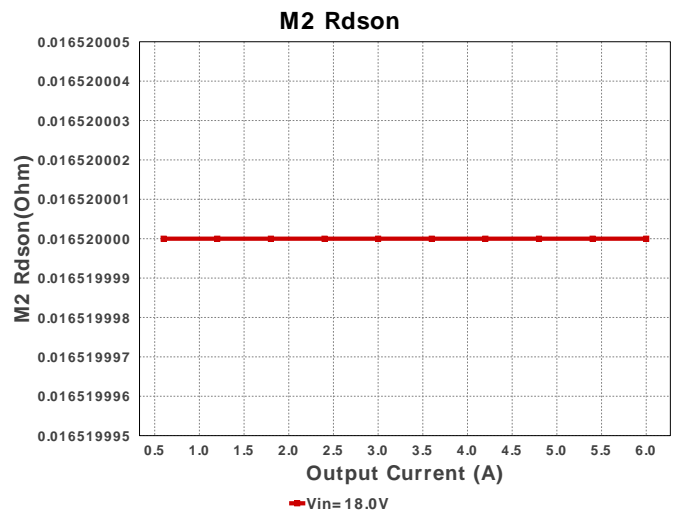
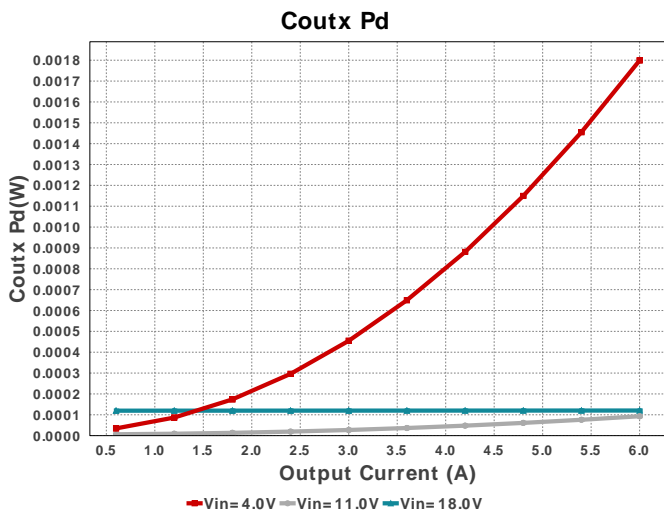
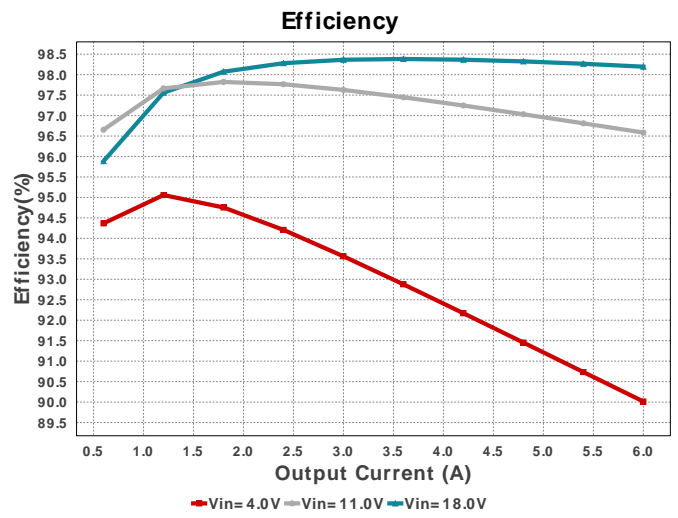
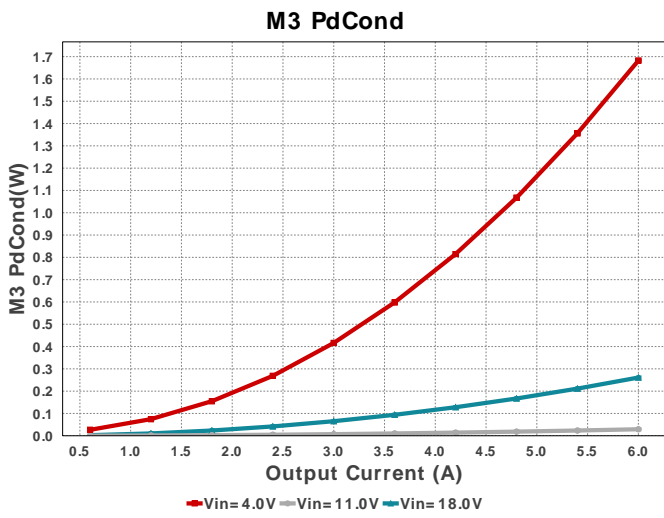
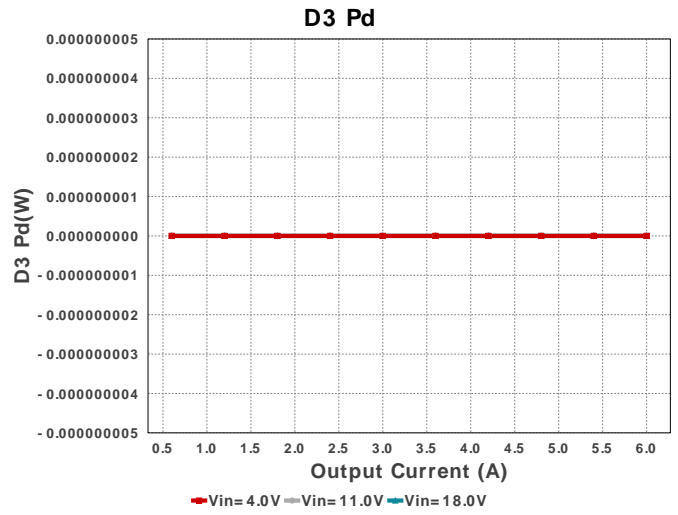
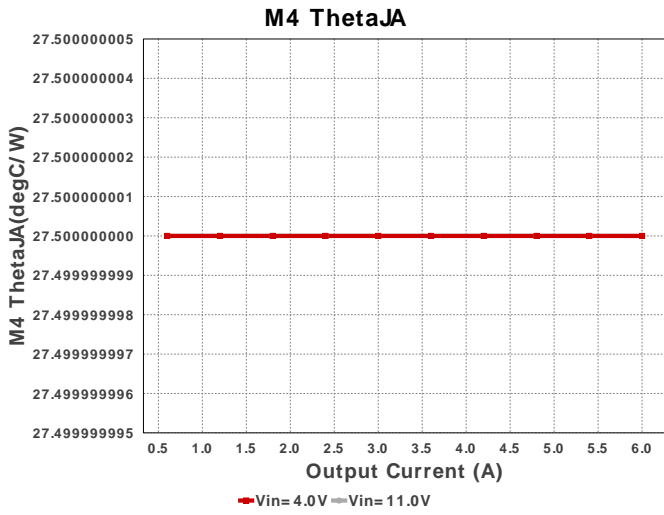

M4 PdCond

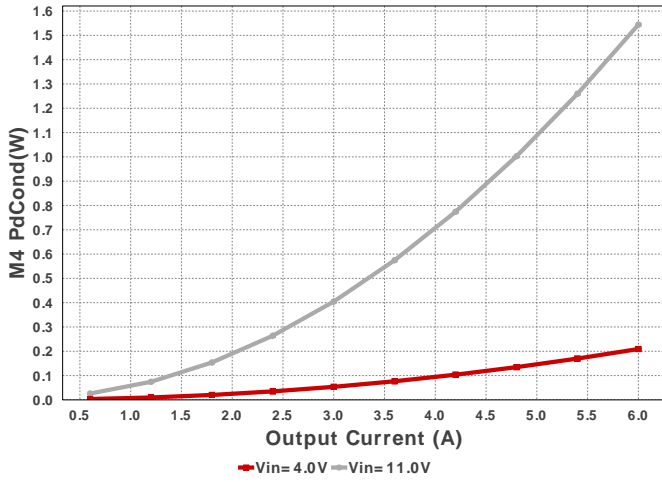

M2 ThetaJA

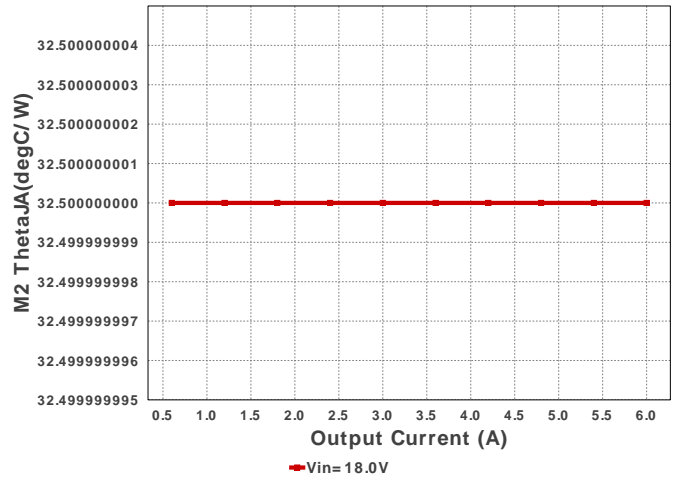

M1 Rdson

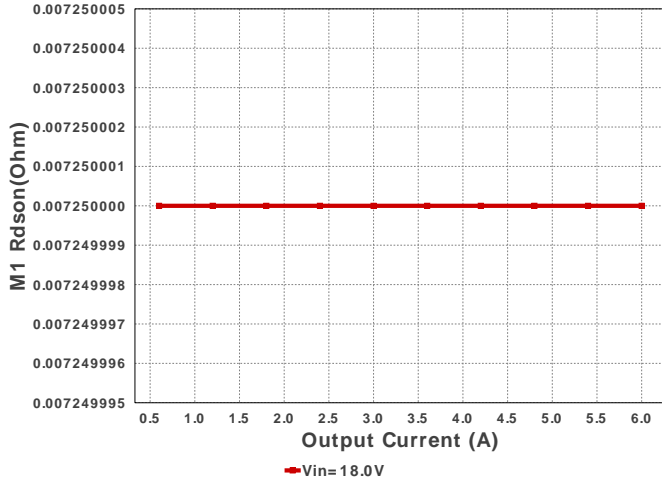

M4 Rdson

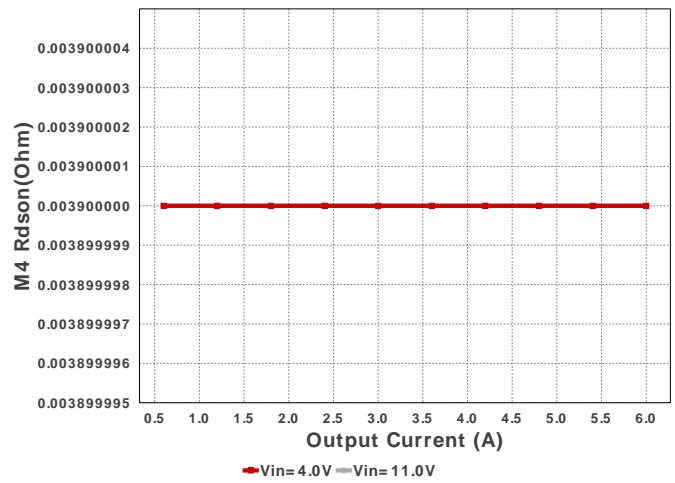

M2 Pd

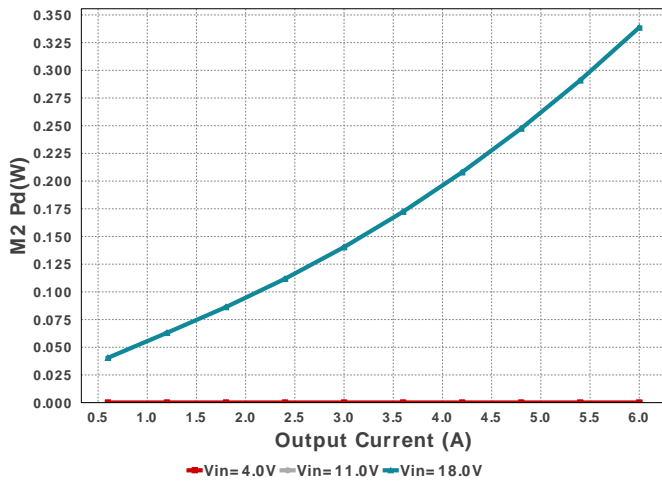

Pout

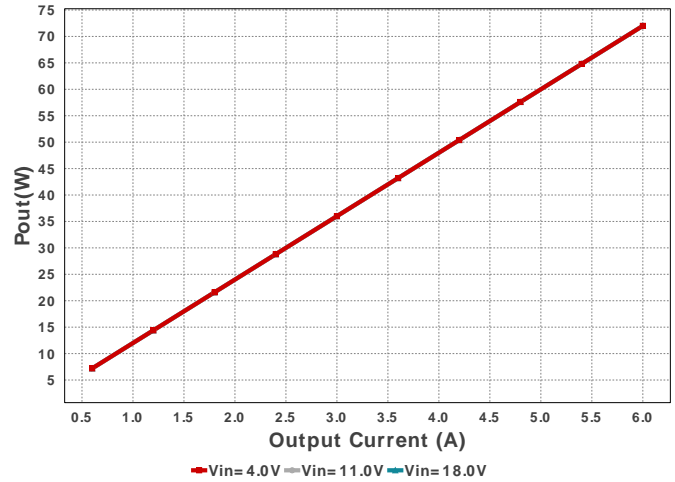

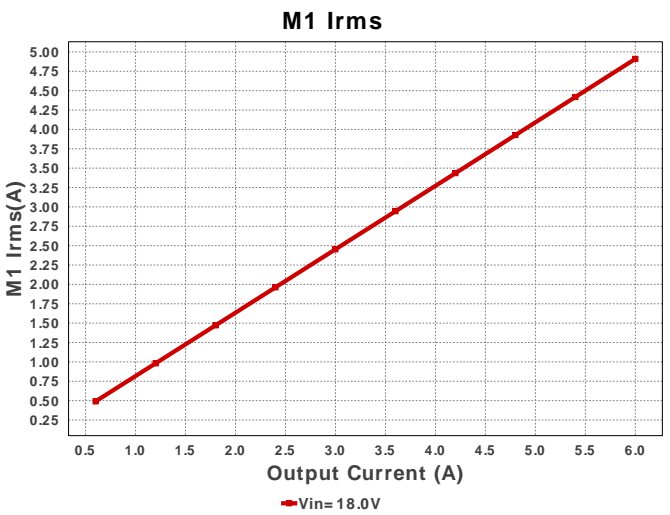
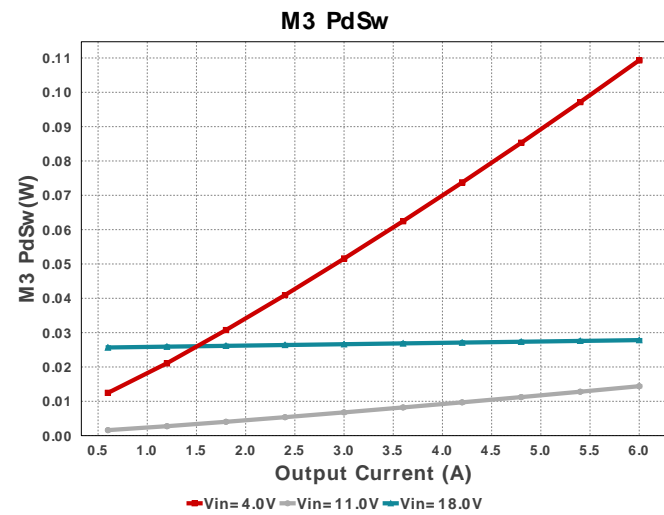
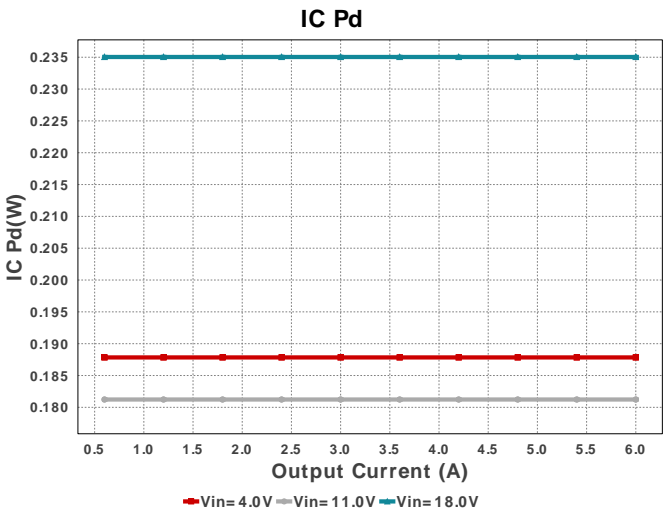
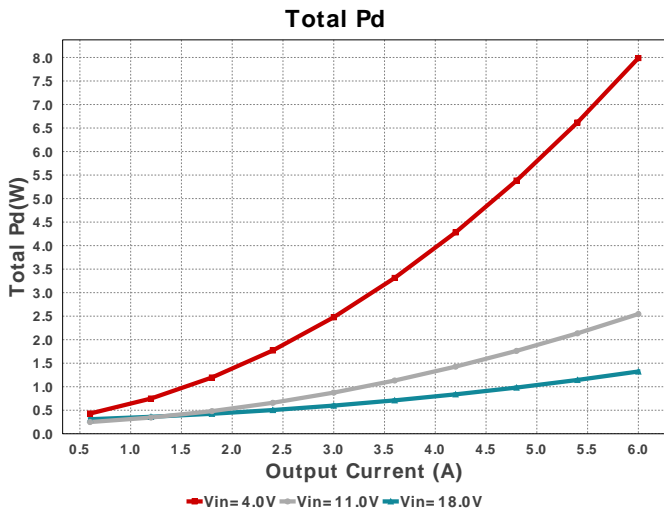
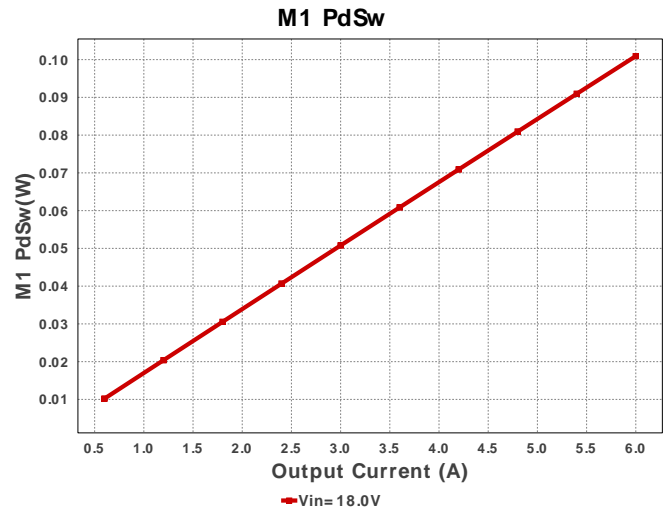
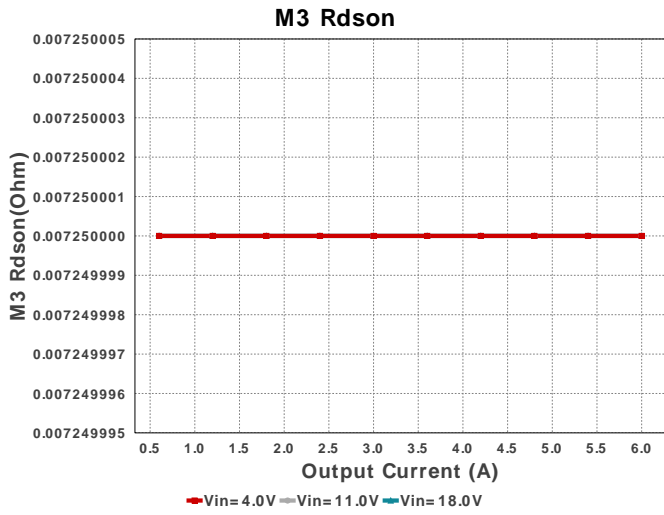

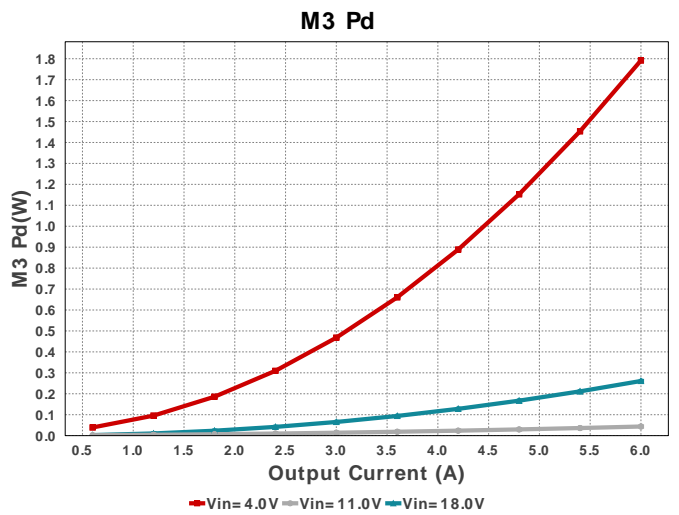
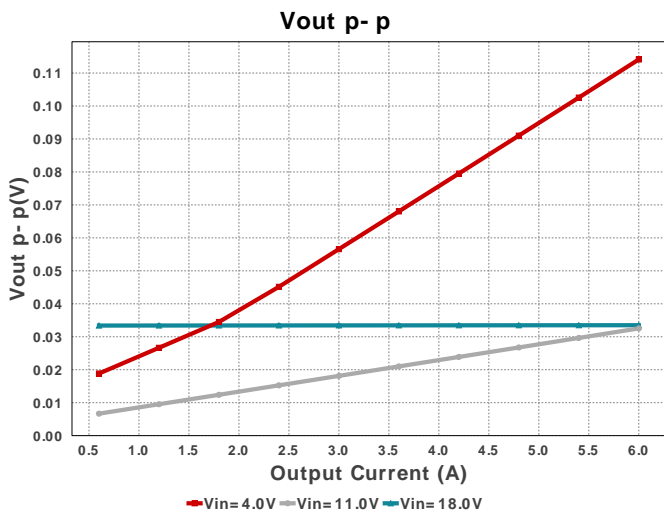
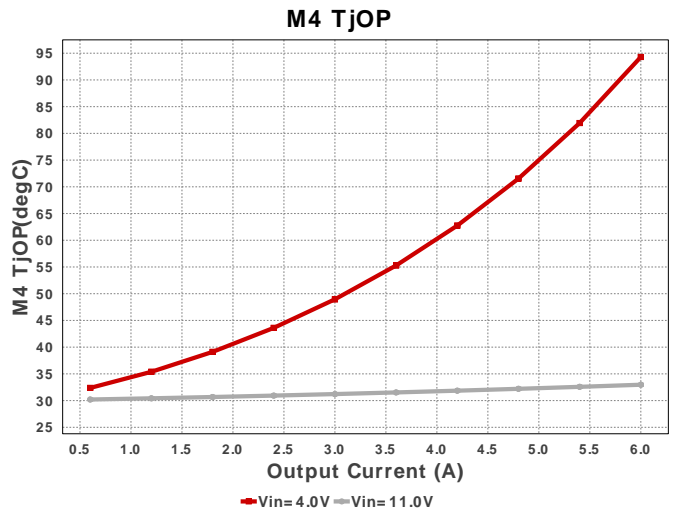
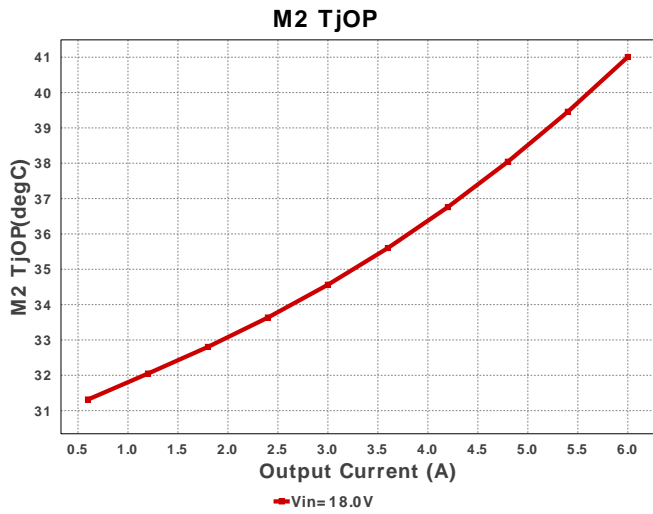
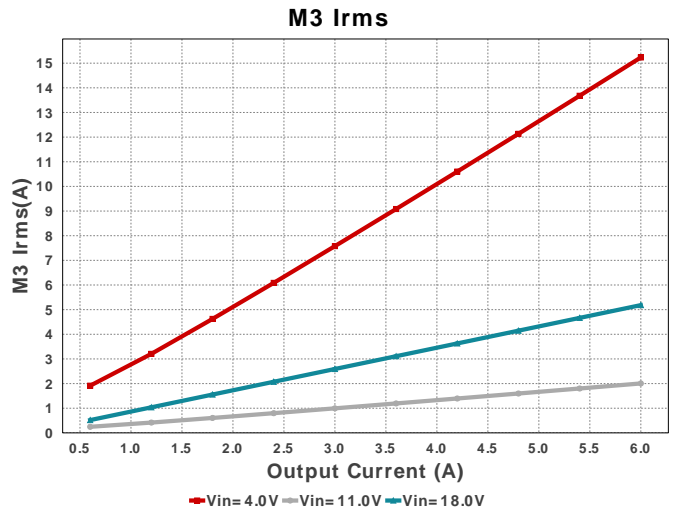
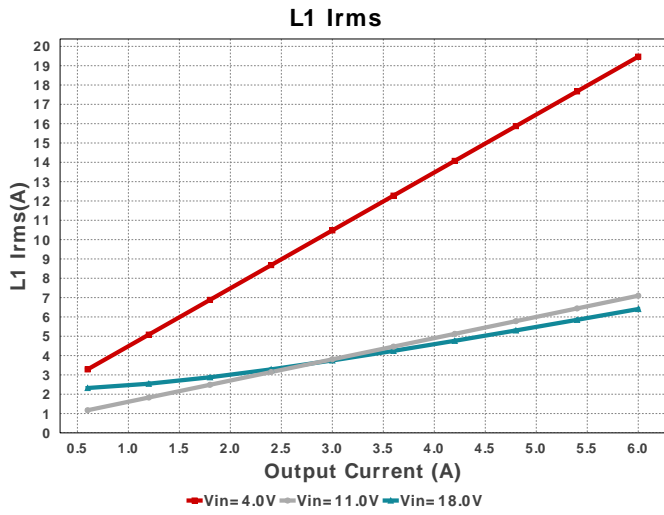

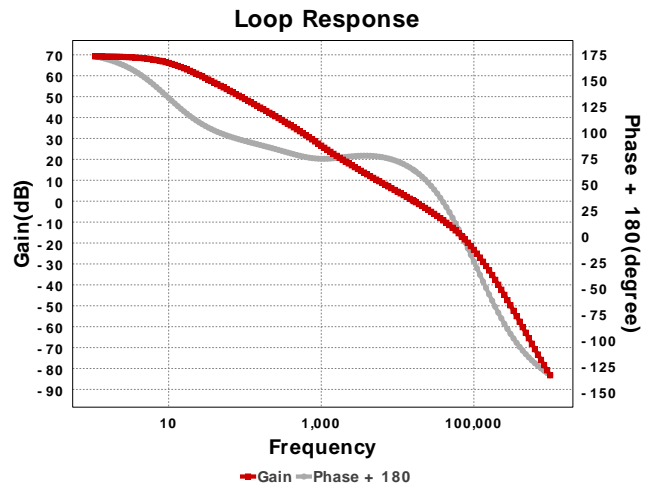
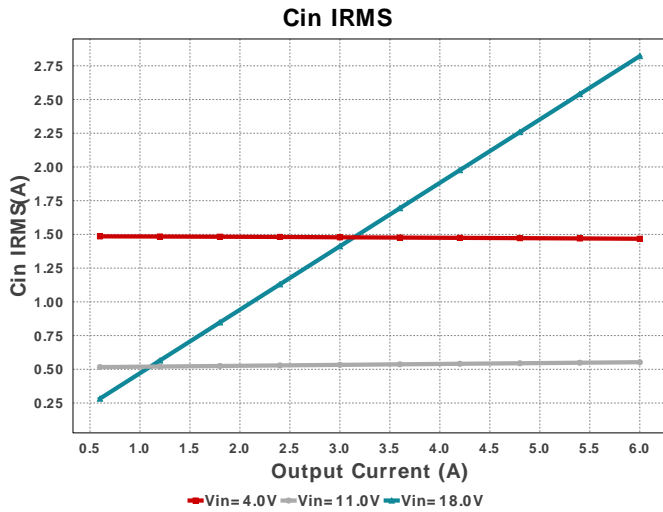

Operating Values

#	Name	Value	Category	Description
1.	Cin IRMS	2.815 A	Capacitor	Input capacitor RMS ripple current
2.	Cin Pd	8.123 mW	Capacitor	Input capacitor power dissipation
3.	Cout IRMS	1.766 A	Capacitor	Output capacitor RMS ripple current
4.	Cout Pd	17.163 mW	Capacitor	Output capacitor power dissipation
5.	Coutx IRMS	493.034 mA	Capacitor	Output capacitor_x RMS ripple current
6.	Coutx Pd	121.54 μ W	Capacitor	Output capacitor_x power loss
7.	D2 Pd	0.0 W	Diode	Diode power dissipation
8.	D3 Pd	0.0 W	Diode	Diode power dissipation
9.	IC Pd	139.23 mW	IC	IC power dissipation
10.	IC Tj	34.247 degC	IC	IC junction temperature
11.	IC Tolerance	0.0 V	IC	IC Feedback Tolerance
12.	ICThetaJA	30.5 degC/W	IC	IC junction-to-ambient thermal resistance
13.	Iin Avg	4.105 A	IC	Average input current
14.	L Ipp	7.827 A	Inductor	Peak-to-peak inductor ripple current
15.	L Pd	117.0 mW	Inductor	Inductor power dissipation
16.	L1 Irms	6.411 A	Inductor	Inductor ripple current
17.	M1 Irms	4.922 A	Mosfet	MOSFET RMS ripple current
18.	M1 Pd	276.23 mW	Mosfet	MOSFET power dissipation
19.	M1 PdCond	187.92 mW	Mosfet	M1 MOSFET conduction losses
20.	M1 PdSw	88.311 mW	Mosfet	M1 MOSFET switching losses
21.	M1 Rdson	7.25 mOhm	Mosfet	Drain-Source On-resistance
22.	M1 ThetaJA	32.5 degC/W	Mosfet	MOSFET junction-to-ambient thermal resistance
23.	M1 TjOP	38.977 degC	Mosfet	MOSFET junction temperature
24.	M2 Irms	3.432 A	Mosfet	MOSFET RMS ripple current
25.	M2 Pd	1.018 W	Mosfet	MOSFET power dissipation
26.	M2 PdCond	943.62 mW	Mosfet	M2 MOSFET conduction losses
27.	M2 PdSw	74.857 mW	Mosfet	M2 MOSFET switching losses
28.	M2 Rdson	66.08 mOhm	Mosfet	Drain-Source On-resistance
29.	M2 ThetaJA	65.0 degC/W	Mosfet	MOSFET junction-to-ambient thermal resistance
30.	M2 TjOP	96.201 degC	Mosfet	MOSFET junction temperature
31.	M3 Irms	10.995 A	Mosfet	MOSFET RMS ripple current
32.	M3 Pd	261.0 mW	Mosfet	M3 MOSFET total power dissipation
33.	M3 PdCond	261.0 mW	Mosfet	M3 MOSFET conduction losses
34.	M3 PdSw	28.21 mW	Mosfet	M3 MOSFET switching losses
35.	M3 ThetaJA	32.5 degC/W	Mosfet	MOSFET junction-to-ambient thermal resistance
36.	M3 TjOP	66.842 degC	Mosfet	MOSFET junction temperature
37.	M4 Pd	0.0 W	Mosfet	M4 MOSFET total power dissipation
38.	Cin Pd	8.123 mW	Power	Input capacitor power dissipation
39.	Cout Pd	17.163 mW	Power	Output capacitor power dissipation
40.	Coutx Pd	121.54 μ W	Power	Output capacitor_x power loss
41.	D2 Pd	0.0 W	Power	Diode power dissipation
42.	D3 Pd	0.0 W	Power	Diode power dissipation
43.	IC Pd	139.23 mW	Power	IC power dissipation
44.	L Pd	117.0 mW	Power	Inductor power dissipation
45.	M1 Pd	276.23 mW	Power	MOSFET power dissipation
46.	M1 PdCond	187.92 mW	Power	M1 MOSFET conduction losses
47.	M1 PdSw	88.311 mW	Power	M1 MOSFET switching losses
48.	M2 Pd	1.018 W	Power	MOSFET power dissipation
49.	M2 PdCond	943.62 mW	Power	M2 MOSFET conduction losses
50.	M2 PdSw	74.857 mW	Power	M2 MOSFET switching losses
51.	M3 Pd	261.0 mW	Power	M3 MOSFET total power dissipation
52.	M3 PdCond	261.0 mW	Power	M3 MOSFET conduction losses

#	Name	Value	Category	Description
53.	M3 PdSw	28.21 mW	Power	M3 MOSFET switching losses
54.	M3 Rdson	7.25 mOhm	Power	Drain-Source On-resistance
55.	M4 Pd	0.0 W	Power	M4 MOSFET total power dissipation
56.	Rsense Pd	57.218 mW	Power	LED Current Rsns Power Dissipation
57.	Total Pd	1.895 W	Power	Total Power Dissipation
58.	Rsense Pd	57.218 mW	Resistor	LED Current Rsns Power Dissipation
59.	BOM Count	47	System Information	Total Design BOM count
60.	Cross Freq	16.467 kHz	System Information	Bode plot crossover frequency
61.	Duty Cycle	67.281 %	System Information	Duty cycle
62.	Efficiency	97.436 %	System Information	Steady state efficiency
63.	FootPrint	1.056 k mm ²	System Information	Total Foot Print Area of BOM components
64.	Frequency	343.832 kHz	System Information	Switching frequency
65.	Gain Marg	-17.127 dB	System Information	Bode Plot Gain Margin
66.	Iout	6.0 A	System Information	Iout operating point
67.	Low Freq Gain	69.217 dB	System Information	Gain at 1Hz
68.	Mode	CCM	System Information	Conduction Mode
69.	Operating Topology	Buck	System Information	The current operating topology of the device
70.	Phase Marg	64.033 deg	System Information	Bode Plot Phase Margin
71.	Pout	72.0 W	System Information	Total output power
72.	SW Ipk	0.0 A	System Information	Peak switch current
73.	Total BOM	NA	System Information	Total BOM Cost
74.	Vin	18.0 V	System Information	Vin operating point
75.	Vout	12.0 V	System Information	Operational Output Voltage
76.	Vout Actual	12.0 V	System Information	Vout Actual calculated based on selected voltage divider resistors
77.	Vout Tolerance	1.886 %	System Information	Vout Tolerance based on IC Tolerance (no load) and voltage divider resistors if applicable
78.	Vout p-p	33.656 mV	System Information	Peak-to-peak output ripple voltage

Design Inputs

#	Name	Value	Description
1.	Iout	6.0	Maximum Output Current
2.	VinMax	18.0	Maximum input voltage
3.	VinMin	4.0	Minimum input voltage
4.	Vout	12.0	Output Voltage
5.	base_pn	LM5175	Base Product Number
6.	source	DC	Input Source Type
7.	Ta	30.0	Ambient temperature

Design Assistance

1. Tip: Snubbers and/or gate resistors may be required to limit the SW1,2 node switching spikes below the IC and FET abs max ratings.
2. Tip: Slope Capacitor: smaller slope capacitors provide better transition region behavior.
3. **LM5175** Product Folder : <http://www.ti.com/product/LM5175> : contains the data sheet and other resources.

Important Notice and Disclaimer

TI provides technical and reliability data (including datasheets), design resources (including reference designs), application or other design advice, web tools, safety information, and other resources AS IS and with all faults, and disclaims all warranties. These resources are intended for skilled developers designing with TI products. You are solely responsible for (1) selecting the appropriate TI products for your application, (2) designing, validating and testing your application, and (3) ensuring your application meets applicable standards, and any other safety, security, or other requirements.

These resources are subject to change without notice. TI grants you permission to use these resources only for development of an application that uses the TI products described in the resource. Other reproduction and display of these resources is prohibited. No license is granted to any other TI intellectual property right or to any third party intellectual property right. TI disclaims responsibility for, and you will fully indemnify TI and its representatives against, any claims, damages, costs, losses, and liabilities arising out of your use of these resources.

Providing these resources does not expand or otherwise alter TI's applicable Terms of Sale or other applicable terms available either on ti.com or provided in conjunction with TI products.