

6 5 4 3 2 1

REVISIONS/REVISED		
1.00	DESIGNER	APPROVED DATE

DC ADAPTOR

Adaptor DC Input (15V, 2.4A Max)

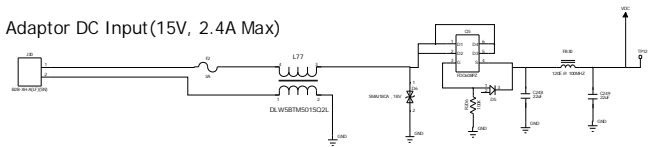

Battery Charging Circuit

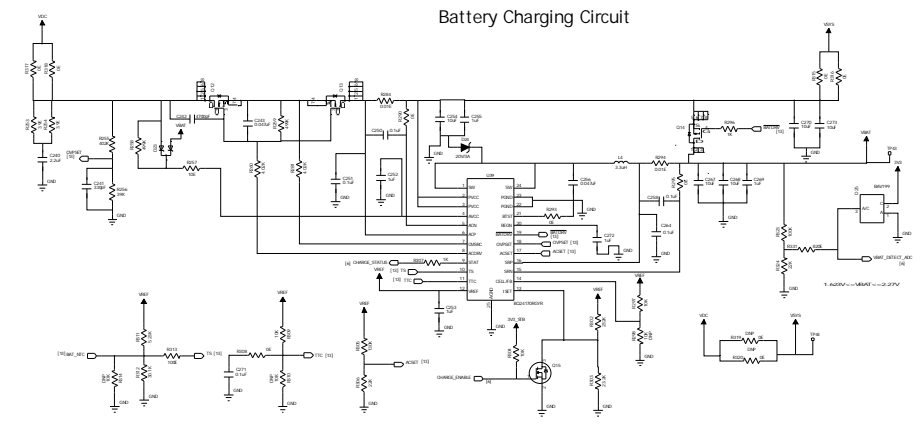

Battery Input Connector

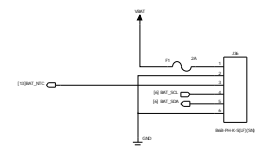

DRAWN BY		AWAK Technologies			
TITLE		MCU Board			
DESIGNED BY	DATE	CODE	REV	DESCRIPTION	REV
DESIGNED BY	DATE	<Code>	D	OTG-PCB-01-03	3.0
DESIGNED BY	DATE	DESIGNED BY	DATE	DESIGNED BY	DATE

6 5 4 3 2 1

REV	DATE	BY	CHKD

POWER SUPPLY

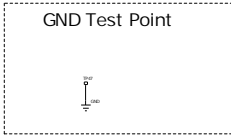
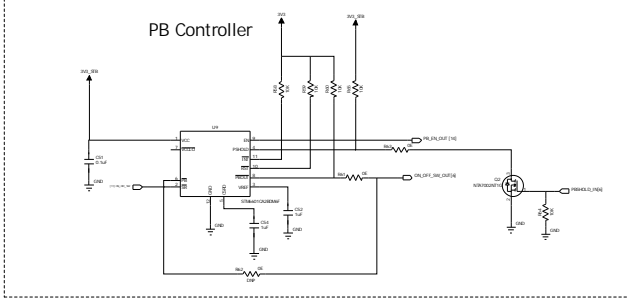
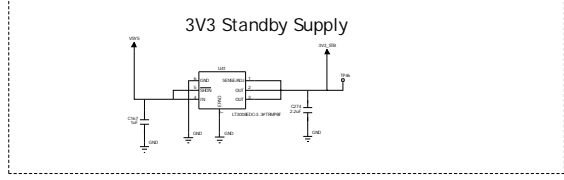
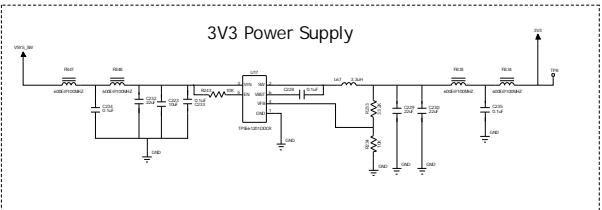
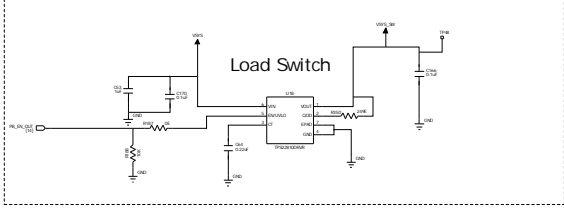
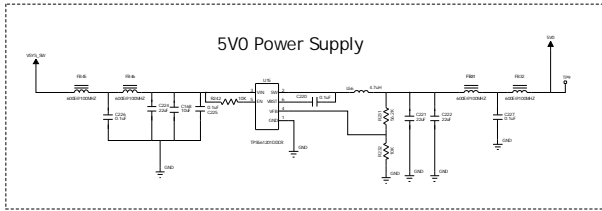

AWAK Technologies			
TITLE: MCU Board			
DESIGNED BY	DESIGNED DATE	CODE	REV
Checked By:	Checked Date:	<Code>	D
CAPABILITY CAPABILITY	DESIGNED	OTG-PCB-01-03	3.0
Released By:	Released Date:	Scale:	1:1

D

C

B

A

D

C

B

A