

5V to 0.85V 40A Stacked Regulator-1

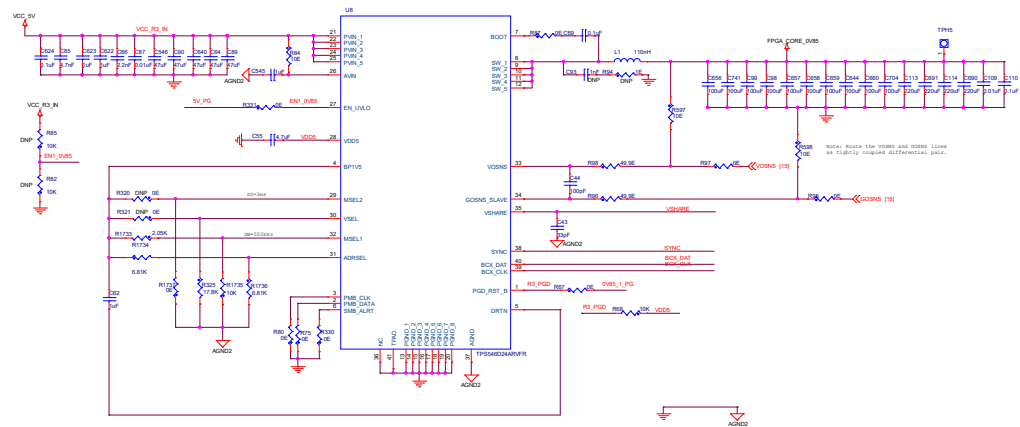

5V to 0.85V 40A Stacked Regulator-2

