

12V to 0.85V 25A Stacked Regulator 1

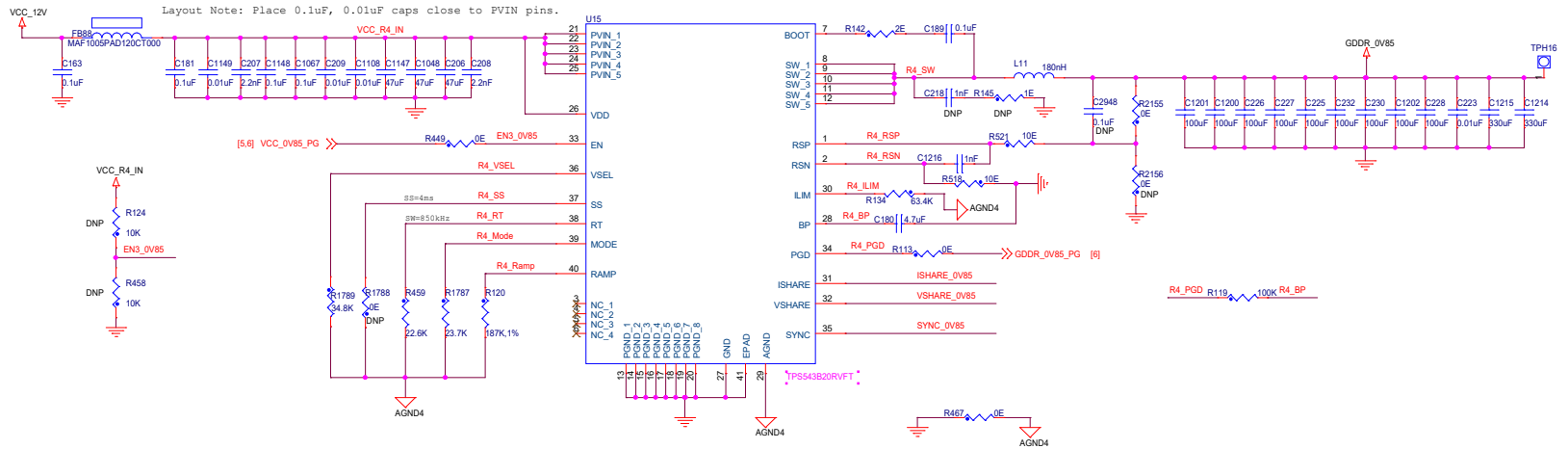

12V to 0.85V 25A Stacked Regulator 2

