

5V to 0.85V 25A Stacked Regulator 1 for GDDR rail

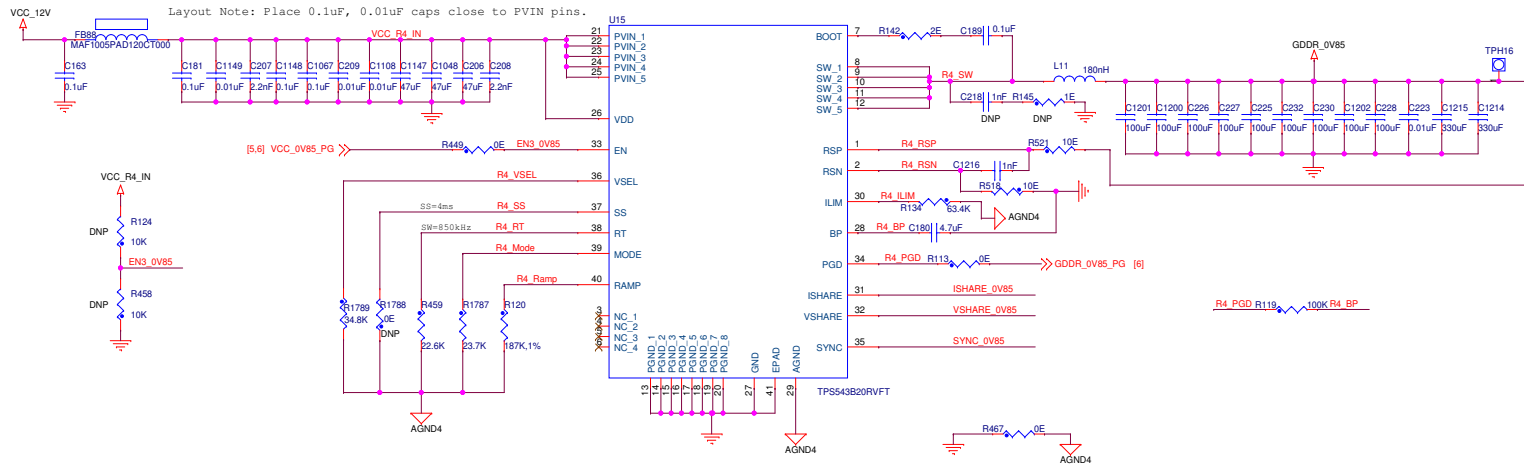

5V to 0.85V 25A Stacked Regulator 2 for GDDR rail

