

VinMin = 90.0V
 VinMax = 265.0V
 Vout = 20.0V
 Iout = 2.0A

Device = UCC28701DBVR
 Topology = Flyback
 Created = 2023-03-03 12:19:26.570
 BOM Cost = NA
 BOM Count = 32
 Total Pd = 13.08W

WEBENCH[®] Design Report

Design : 6 UCC28701DBVR
 UCC28701DBVR 90V-265V to 20.00V @ 2A

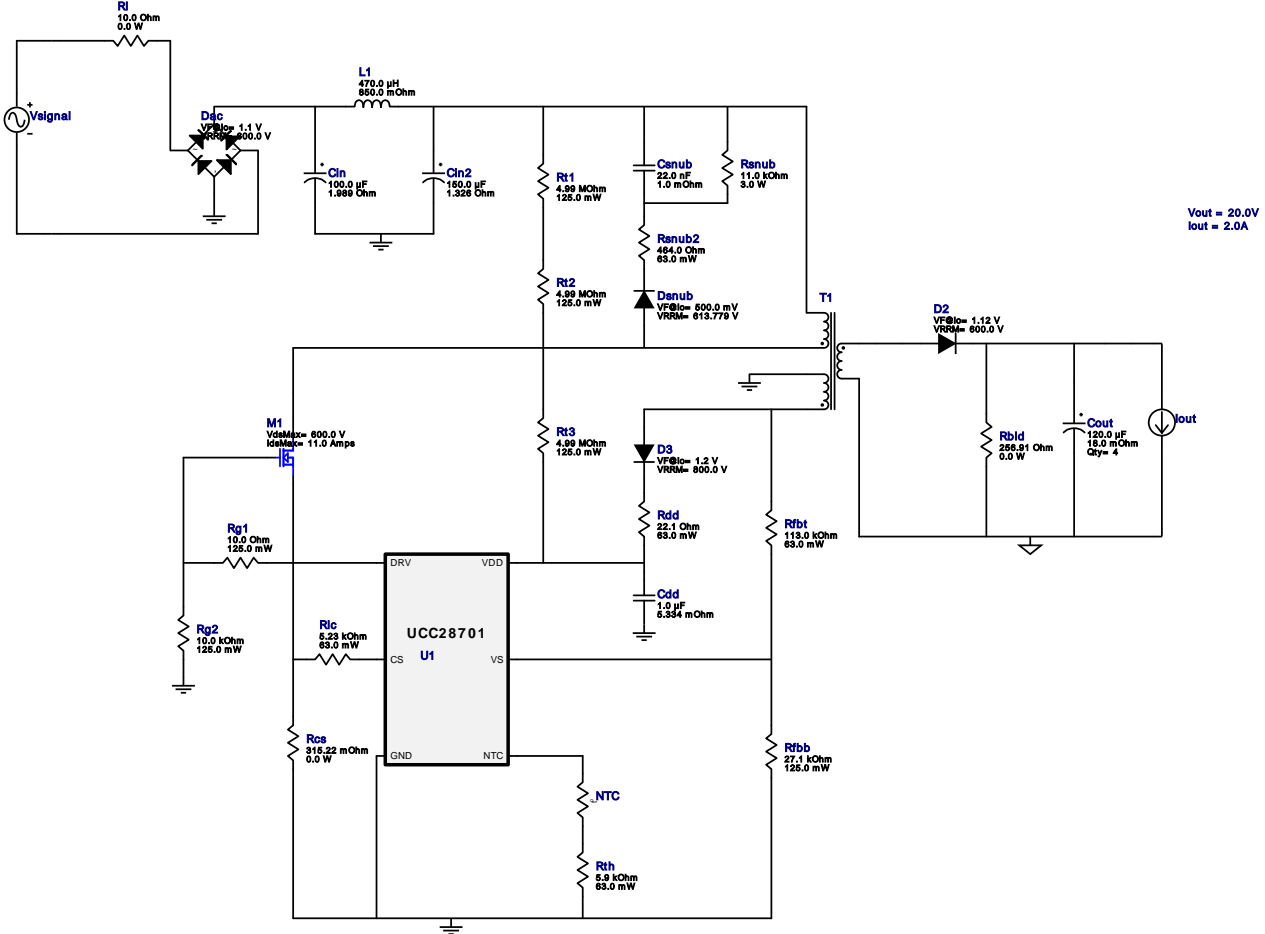

1. R1bd is a starting point, but may need to be experimented with in order to get minimum current needed to hold Vout at no load. R1c and the feedback resistors may also need adjustment based on the actual transformer used. It is recommended to start this device at light load condition. There is an internal series resistance of 28 kOhms to the CBC pin which sets a maximum cable compensation of a 5V output to 400 mV when CBC is shorted to ground. For more information please click the design assistance button.
2. Click on the transformer symbol and select 'Design Transformer' to design using specific transformer cores and bobbin

Design Alerts

Component Selection Information

Click on the transformer symbol in the schematic and select "Explore Transformer Core/Bobbin Selection" to design using specific transformer cores and bobbin.

Electrical BOM

Name	Manufacturer	Part Number	Properties	Qty	Price	Footprint
C1d	MuRata	GRM31CR72A105KA01L Series= X7R	Cap= 1.0 uF ESR= 5.334 mOhm VDC= 100.0 V IRMS= 1.55432 A	1	\$0.11	 1206_190 11 mm ²

Name	Manufacturer	Part Number	Properties	Qty	Price	Footprint
Cin	Nichicon	LLS2G101MELZ Series= 2387	Cap= 100.0 uF ESR= 1.989 Ohm VDC= 400.0 V IRMS= 950.0 mA	1	\$1.09	 Nichicon_2200x2500_Snap 576 mm ²
Cin2	Nichicon	LLS2G151MELZ Series= 2387	Cap= 150.0 uF ESR= 1.326 Ohm VDC= 400.0 V IRMS= 1.24 A	1	\$1.38	 Nichicon_2200x3500_Snap 576 mm ²
Cout	Panasonic	35SEPF120M Series= SEPF	Cap= 120.0 uF ESR= 18.0 mOhm VDC= 35.0 V IRMS= 4.4 A	4	\$0.96	 SEPF_F13 144 mm ²
D2	Bourns	CD214C-F3600	VF@Io= 1.12 V VRRM= 600.0 V	1	\$0.23	 SMC 83 mm ²
D3	Microsemi	UFS180JE3/TR13	VF@Io= 1.2 V VRRM= 800.0 V	1	\$0.95	 DO-214BA 42 mm ²
Dac	Diodes Inc.	DF1506S-T	VF@Io= 1.1 V VRRM= 600.0 V	1	\$0.24	 DF-S 99 mm ²
L1	NIC Components	NPI52W471MTRF	L= 470.0 uH 850.0 mOhm	1	\$0.26	 IND_NPI52W 358 mm ²
M1	STMicroelectronics	STF13NM60ND	VdsMax= 600.0 V IdsMax= 11.0 Amps	1	\$2.73	 TO-220FP 79 mm ²
NTC	MuRata	NCP15WD683J03RC Series= NCP15	Thermistor	1	\$0.05	 0402 3 mm ²
Rbld	CUSTOM	CUSTOM Series= ?	Res= 256.91 Ohm Power= 0.0 W Tolerance= 0.0%	1	NA	CUSTOM 0 mm ²
Rcs	CUSTOM	CUSTOM Series= ?	Res= 315.22 mOhm Power= 0.0 W Tolerance= 0.0%	1	NA	CUSTOM 0 mm ²
Rdd	Vishay-Dale	CRCW040222R1FKED Series= CRCW..e3	Res= 22.1 Ohm Power= 63.0 mW Tolerance= 1.0%	1	\$0.01	 0402 3 mm ²
Rfbb	Yageo	RT0805BRD0727K1L Series= ?	Res= 27.1 kOhm Power= 125.0 mW Tolerance= 0.1%	1	\$0.06	 0805 7 mm ²

Name	Manufacturer	Part Number	Properties	Qty	Price	Footprint
Rfbt	Vishay-Dale	CRCW0402113KFKED Series= CRCW..e3	Res= 113.0 kOhm Power= 63.0 mW Tolerance= 1.0%	1	\$0.01	0402 3 mm ²
Rg1	Vishay-Dale	CRCW080510R0FKEA Series= CRCW..e3	Res= 10.0 Ohm Power= 125.0 mW Tolerance= 1.0%	1	\$0.01	0805 7 mm ²
Rg2	Vishay-Dale	CRCW080510K0FKEA Series= CRCW..e3	Res= 10.0 kOhm Power= 125.0 mW Tolerance= 1.0%	1	\$0.01	0805 7 mm ²
RI	CUSTOM	CUSTOM Series= ?	Res= 10.0 Ohm Power= 0.0 W Tolerance= 0.0%	1	NA	CUSTOM 0 mm ²
Rlc	Vishay-Dale	CRCW04025K23FKED Series= CRCW..e3	Res= 5.23 kOhm Power= 63.0 mW Tolerance= 1.0%	1	\$0.01	0402 3 mm ²
Rt1	Vishay-Dale	CRCW08054M99FKEA Series= CRCW..e3	Res= 4.99 MOhm Power= 125.0 mW Tolerance= 1.0%	1	\$0.01	0805 7 mm ²
Rt2	Vishay-Dale	CRCW08054M99FKEA Series= CRCW..e3	Res= 4.99 MOhm Power= 125.0 mW Tolerance= 1.0%	1	\$0.01	0805 7 mm ²
Rt3	Vishay-Dale	CRCW08054M99FKEA Series= CRCW..e3	Res= 4.99 MOhm Power= 125.0 mW Tolerance= 1.0%	1	\$0.01	0805 7 mm ²
Rth	Vishay-Dale	CRCW04025K90FKED Series= CRCW..e3	Res= 5.9 kOhm Power= 63.0 mW Tolerance= 1.0%	1	\$0.01	0402 3 mm ²
T1	Core=TDK , CoilFormer=TDK	Core=B66421G0000X197 , CoilFormer=B66422W1010D001	Lp= 176.0 μH Turns Ratio(Nas)= 8:8 Turns Ratio(Nps)= 38:8 Npri= 38.0 Naux= 8.0 Nsec= 8.0	1	\$0.49	TDK_B66305 756 mm ²
U1	Texas Instruments	UCC28701DBVR	Switcher	1	\$0.38	SOT-23-6 15 mm ²

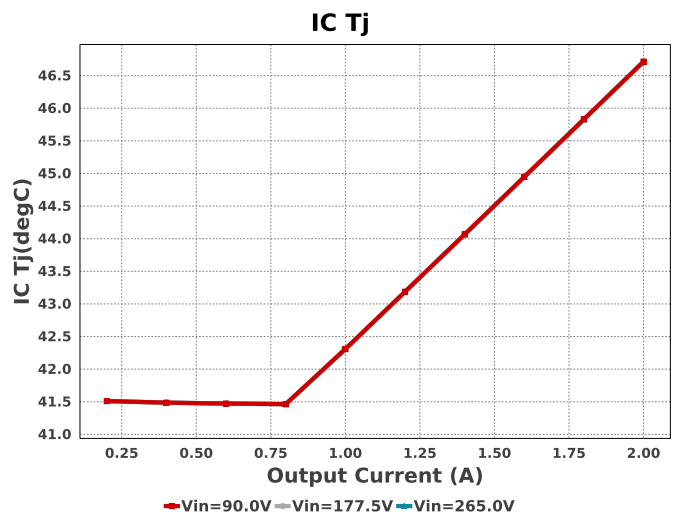
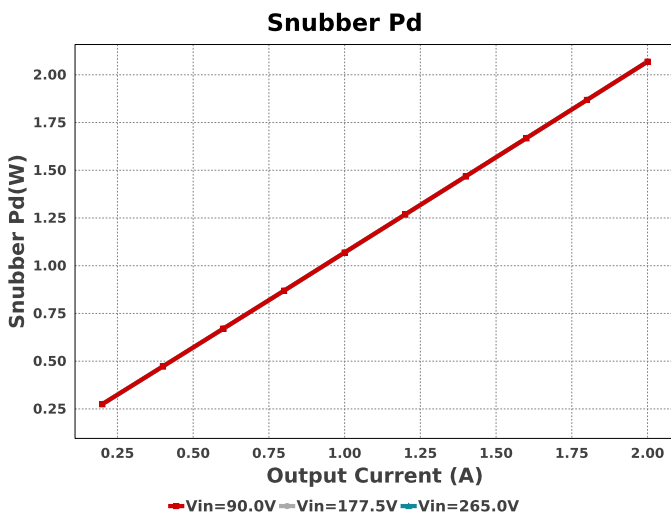

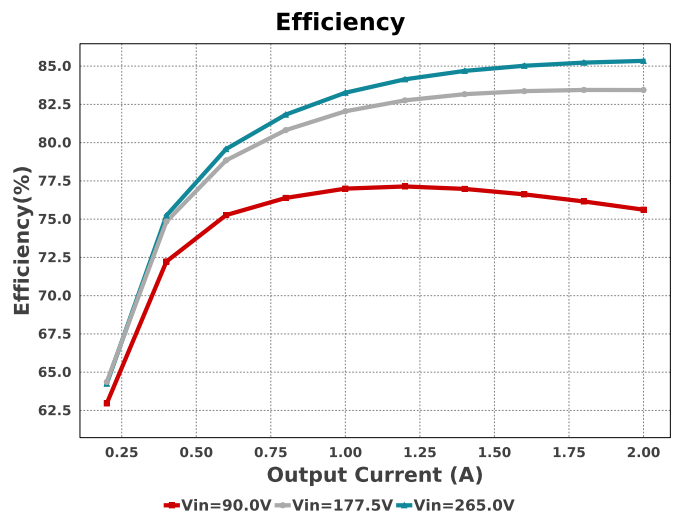
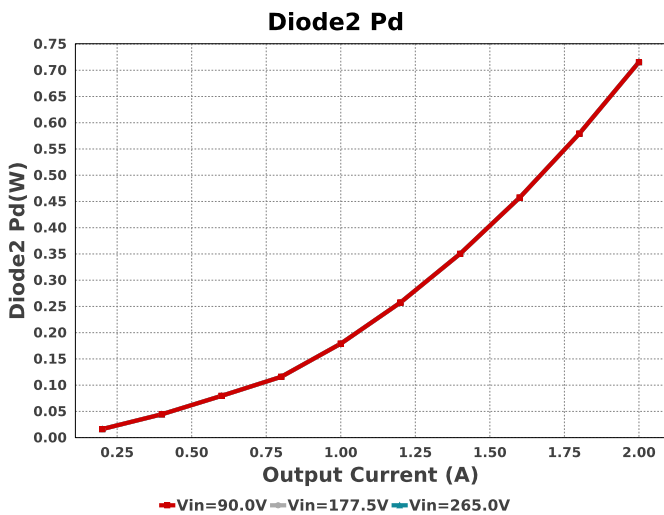
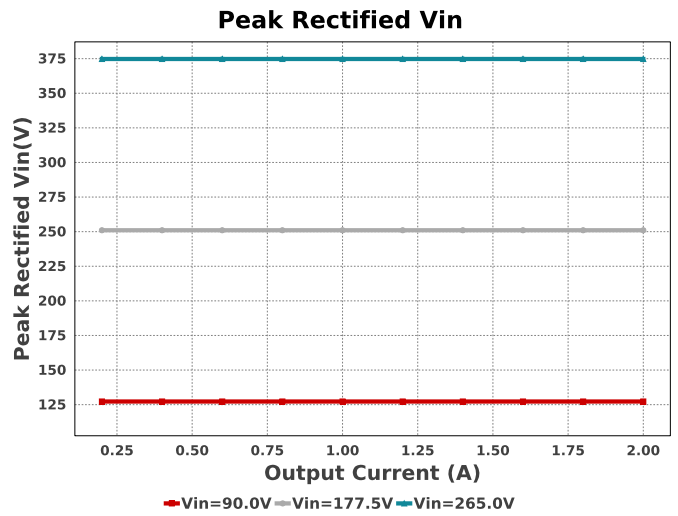
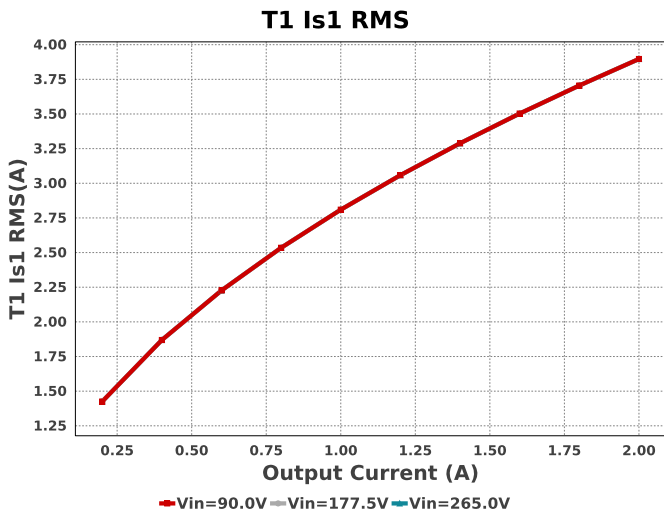
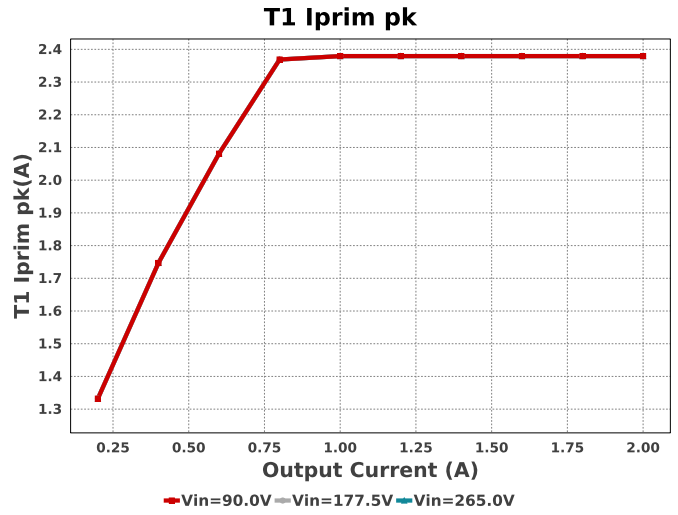
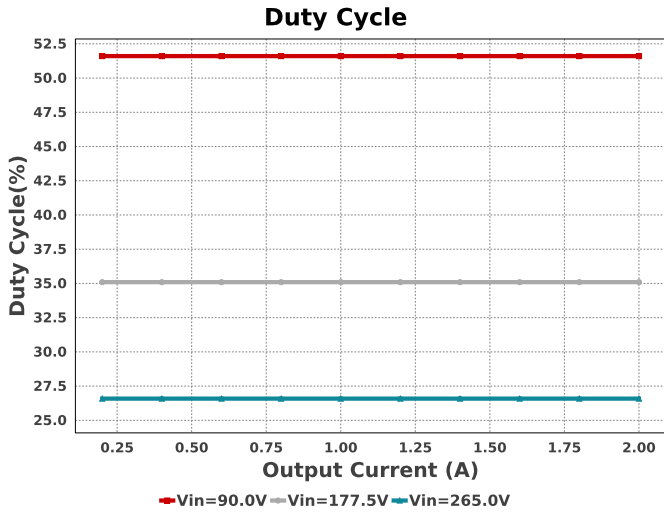

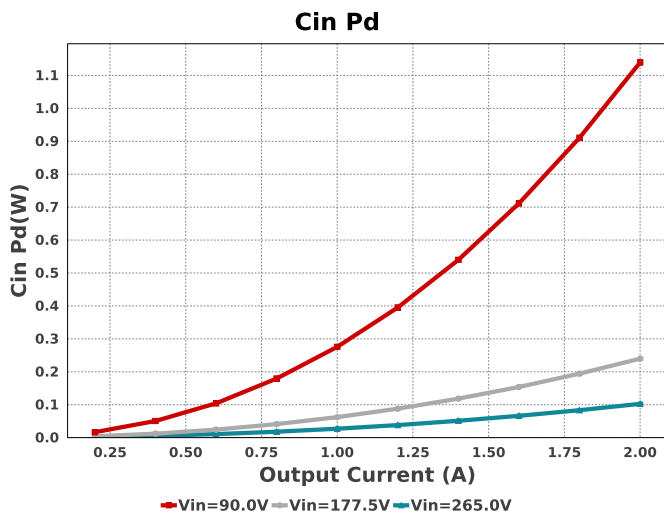
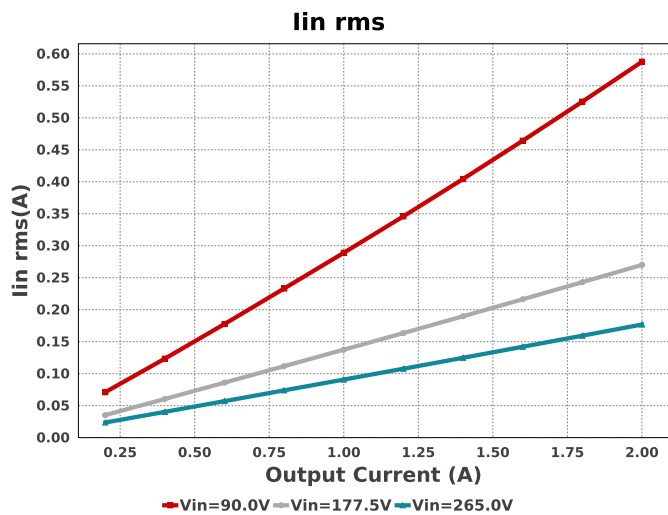
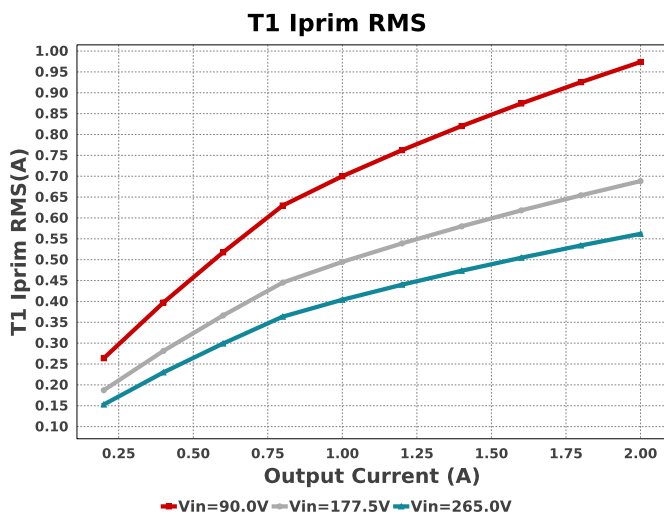
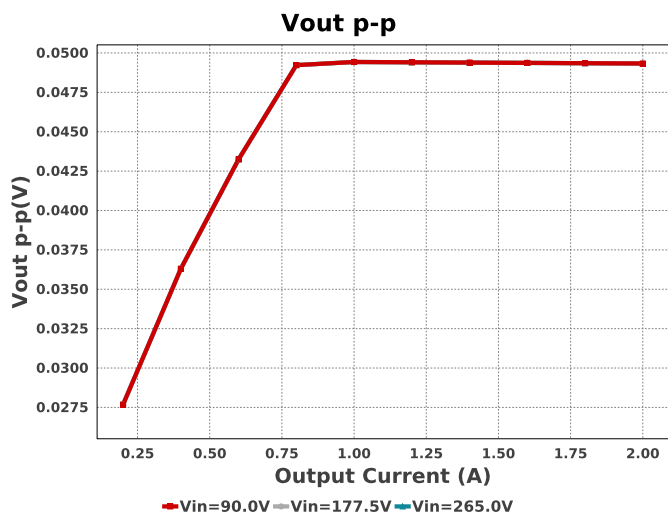
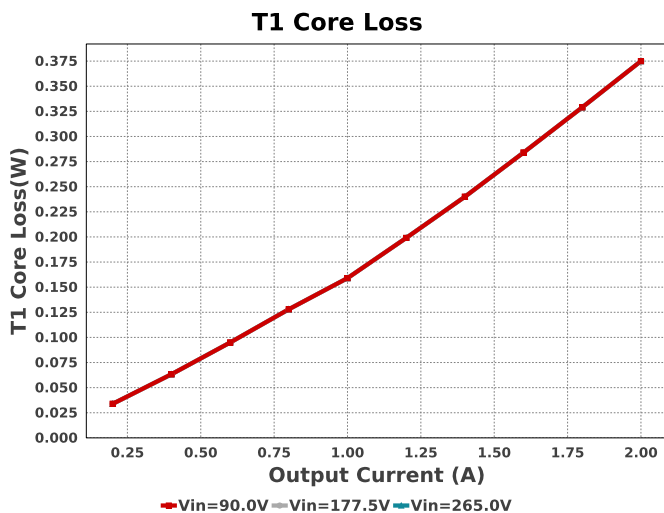
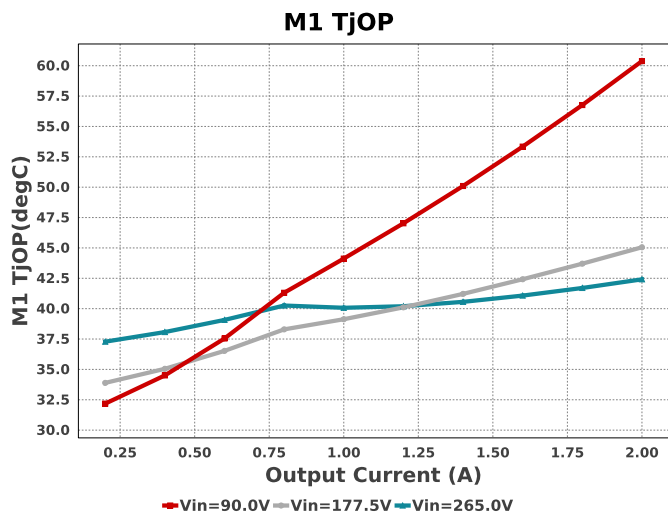

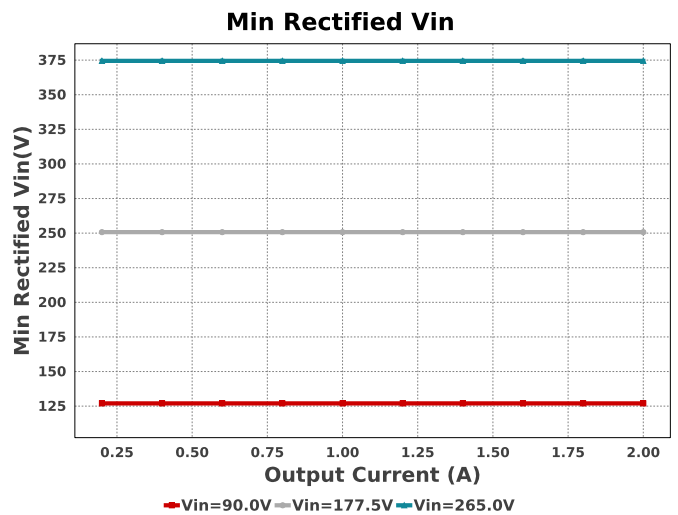
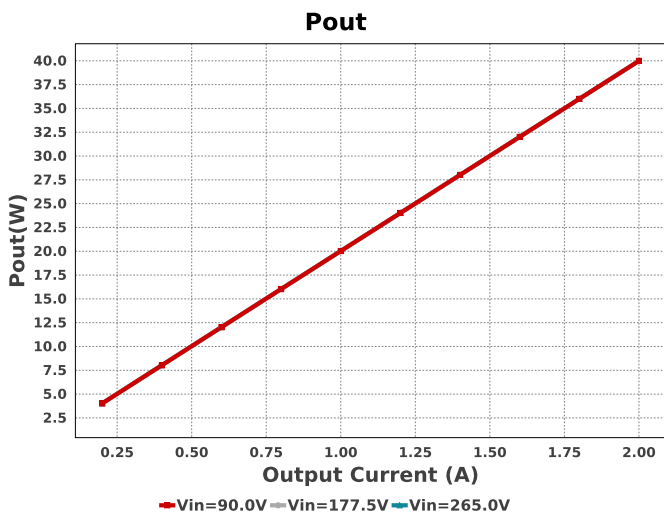
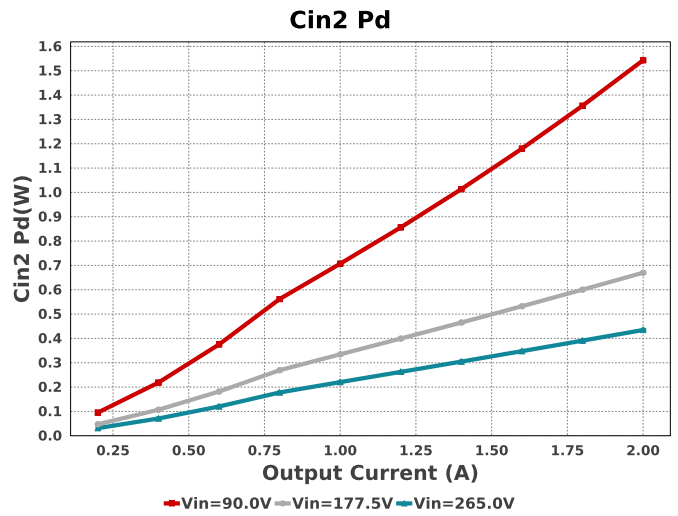
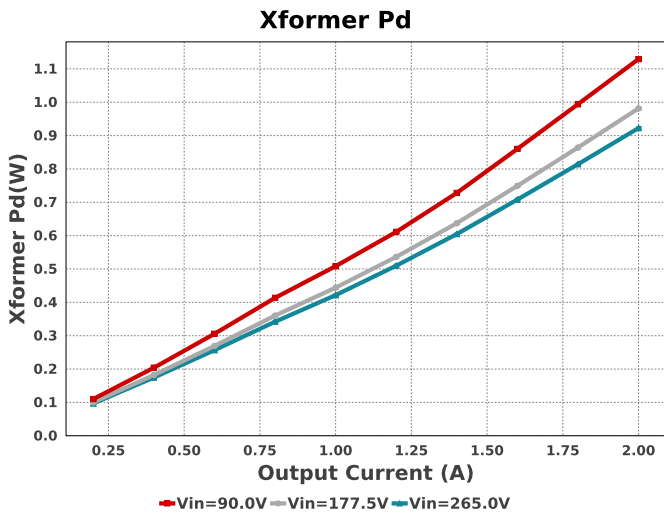
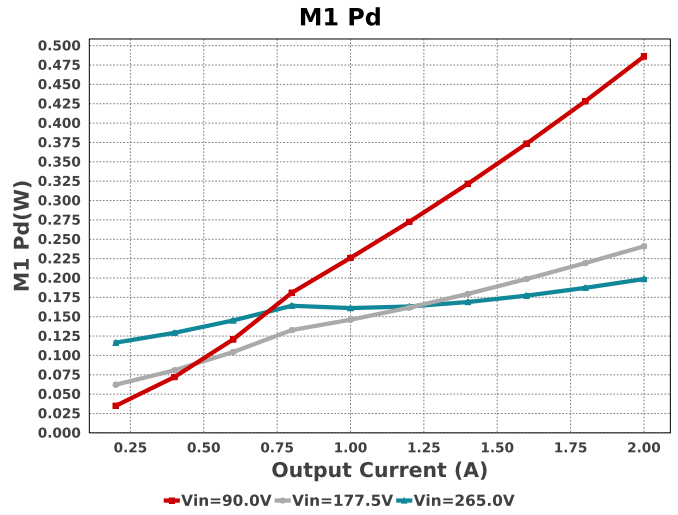
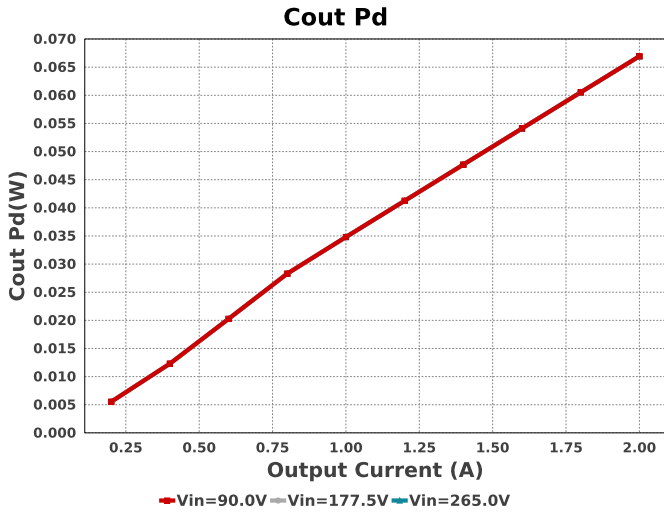

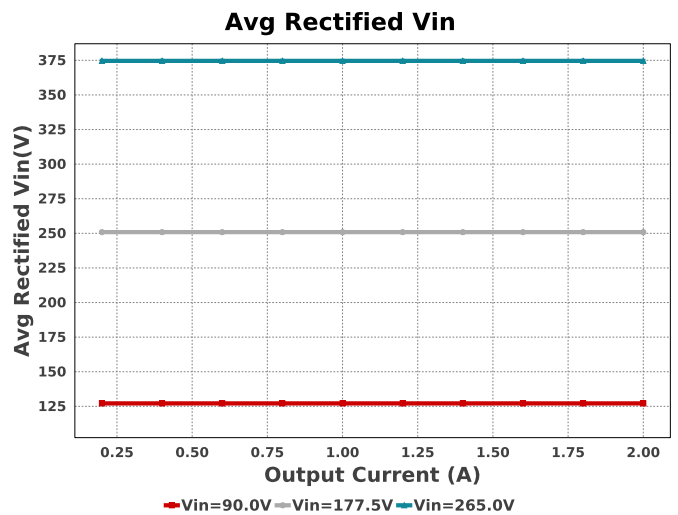
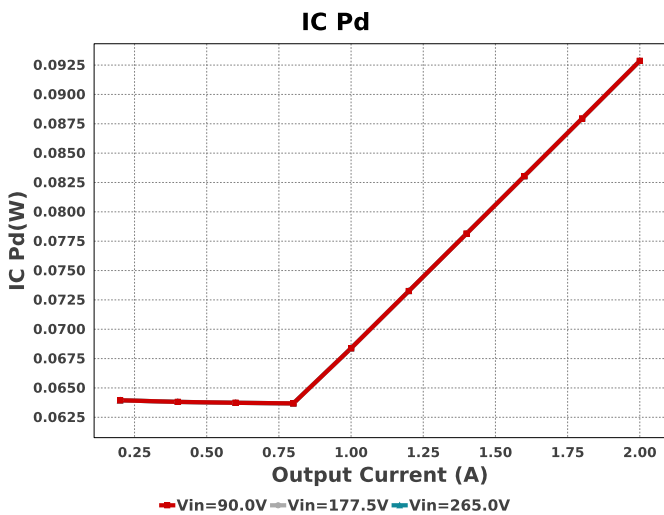
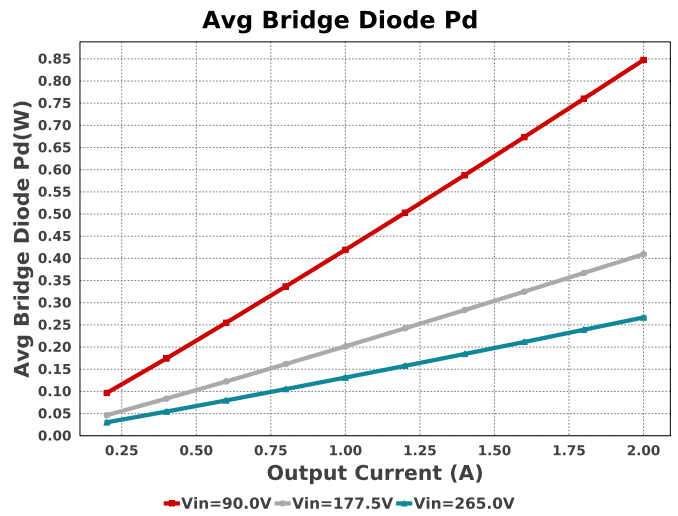
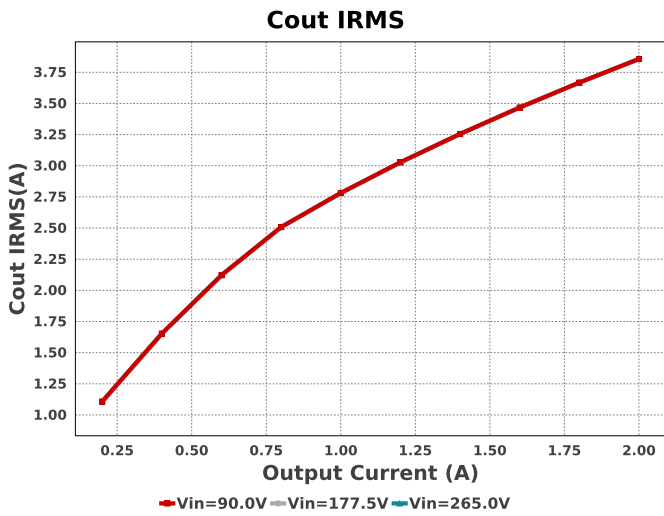
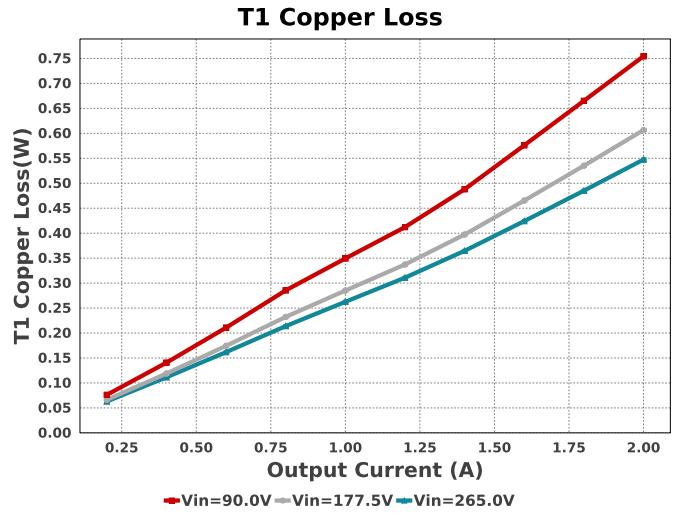
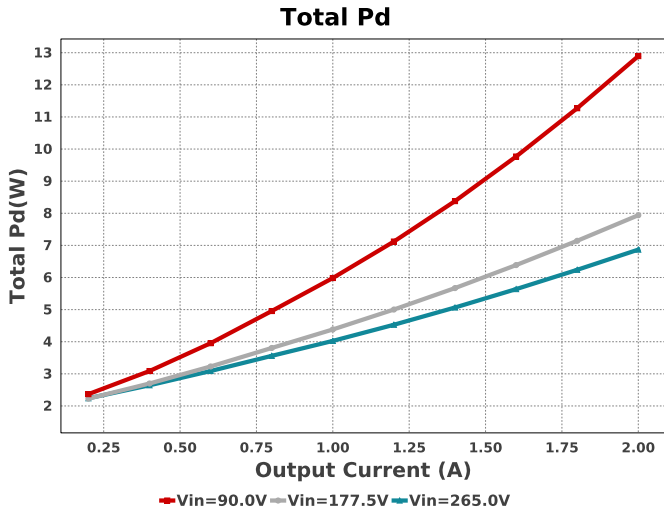

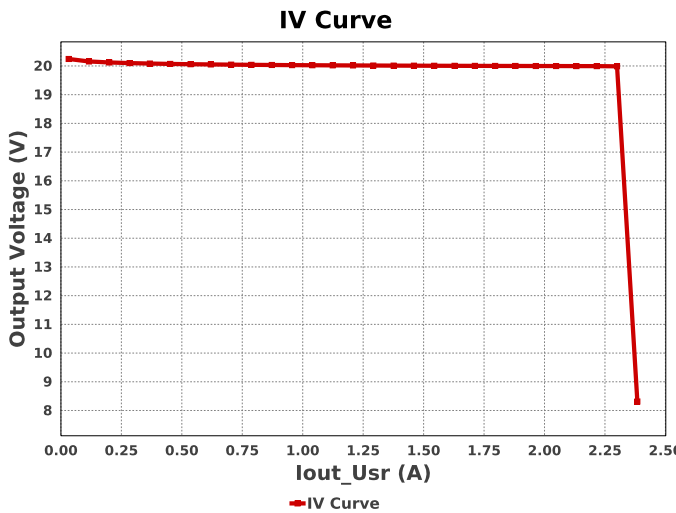
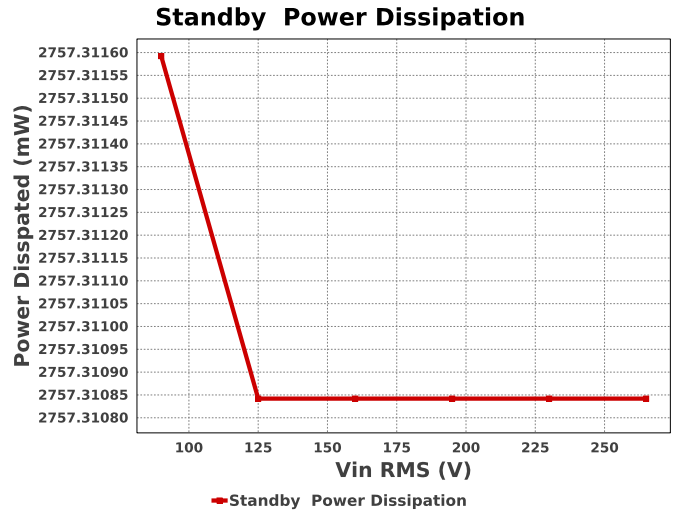
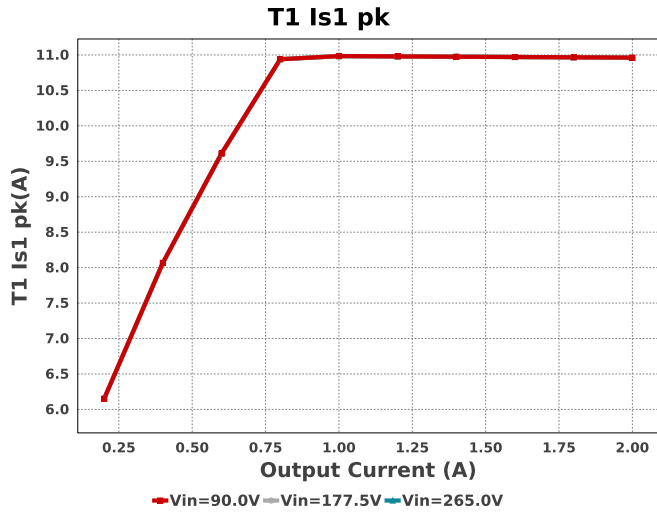

Operating Values

#	Name	Value	Category	Description
1.	Cin Pd	1.147 W	Capacitors	Input capacitor power dissipation
2.	Cin2 Pd	1.548 W	Capacitors	Average Power Dissipation in the Input Capacitor Cin2
3.	Cout IRMS	3.857 A	Capacitors	Output capacitor RMS ripple current
4.	Cout Pd	66.941 mW	Capacitors	Output capacitor power dissipation
5.	Avg Bridge Diode Pd	850.26 mW	Diode	Average Power Dissipation in the Bridge Diode over the AC Line Period
6.	Diode2 Pd	715.55 mW	Diodes	Diode2 power dissipation
7.	IC Pd	92.858 mW	IC	IC power dissipation
8.	IC Tj	46.714 degC	IC	IC junction temperature
9.	ICThetaJA	180.0 degC/W	IC	IC junction-to-ambient thermal resistance
10.	M1 Pd	486.06 mW	Mosfet	M1 MOSFET total power dissipation
11.	M1 TjOP	60.379 degC	Mosfet	M1 MOSFET junction temperature
12.	Avg Bridge Diode Pd	850.26 mW	Power	Average Power Dissipation in the Bridge Diode over the AC Line Period
13.	Cin Pd	1.147 W	Power	Input capacitor power dissipation
14.	Cin2 Pd	1.548 W	Power	Average Power Dissipation in the Input Capacitor Cin2
15.	Cout Pd	66.941 mW	Power	Output capacitor power dissipation
16.	Diode2 Pd	715.55 mW	Power	Diode2 power dissipation
17.	IC Pd	92.858 mW	Power	IC power dissipation
18.	M1 Pd	486.06 mW	Power	M1 MOSFET total power dissipation
19.	Snubber Pd	2.069 W	Power	Snubber Power Dissipation
20.	T1 Copper Loss	900.24 mW	Power	Transformer Copper Loss Power Dissipation
21.	T1 Core Loss	384.0 mW	Power	Transformer Core Loss Power Dissipation
22.	Total Pd	13.084 W	Power	Total Power Dissipation
23.	Xformer Pd	1.284 W	Power	Transformer power dissipation
24.	Avg Rectified Vin	127.128 V	System	Average Rectified Voltage for the AC Line Period
25.	BOM Count	32	System	Total Design BOM count
26.	Duty Cycle	51.604 %	System	Duty cycle
27.	Efficiency	75.349 %	System	Steady state efficiency

#	Name	Value	Category	Description
28.	FootPrint	3.453 k mm ²	System Information	Total Foot Print Area of BOM components
29.	Frequency	103.821 kHz	System Information	Switching frequency
30.	Frequency	103.821 kHz	System Information	Switching frequency
31.	Iin rms	589.76 mA	System Information	RMS Input Current
32.	Iout	2.0 A	System Information	Iout operating point
33.	Min Rectified Vin	126.978 V	System Information	Minimum voltage seen at rectified input
34.	Mode	DCM	System Information	Conduction Mode
35.	Peak Rectified Vin	127.278 V	System Information	Peak voltage seen at rectified input
36.	Pout	39.994 W	System Information	Total output power
37.	Total BOM	NA	System Information	Total BOM Cost
38.	Vin_RMS	90.0 V	System Information	Vin operating point
39.	Vout	19.997 V	System Information	Operational Output Voltage
40.	Vout Actual	19.997 V	System Information	Vout Actual calculated based on selected voltage divider resistors
41.	Vout Tolerance	1.138 %	System Information	Vout Tolerance based on IC Tolerance (no load) and voltage divider resistors if applicable
42.	Vout p-p	49.33 mV	System Information	Peak-to-peak output ripple voltage
43.	T1 Copper Loss	900.24 mW	Transformer	Transformer Copper Loss Power Dissipation
44.	T1 Core Loss	384.0 mW	Transformer	Transformer Core Loss Power Dissipation
45.	T1 Iprim RMS	973.763 mA	Transformer	Transformer Primary RMS Current
46.	T1 Iprim pk	2.379 A	Transformer	Transformer Primary Peak Current
47.	T1 Is1 RMS	3.897 A	Transformer	Transformer Secondary1 RMS Current
48.	T1 Is1 pk	10.962 A	Transformer	Transformer Secondary1 Peak Current
49.	Xformer Pd	1.284 W	Transformer	Transformer power dissipation

Design Inputs

Name	Value	Description
Iout	2.0	Maximum Output Current
VinMax	265.0	Maximum input voltage
VinMin	90.0	Minimum input voltage
Vout	20.0	Output Voltage
acFrequency	60.0	AC Frequency
base_pn	UCC28701	Base Product Number
source	AC	Input Source Type
Ta	30.0	Ambient temperature
UserFsw	100.0 k	Customer Selected Frequency

WEBENCH® Assembly

Component Testing

Some published data on components in datasheets such as Capacitor ESR and Inductor DC resistance is based on conservative values that will guarantee that the components always exceed the specification. For design purposes it is usually better to work with typical values. Since this data is not always available it is a good practice to measure the Capacitance and ESR values of C_{in} and C_{out} , and the inductance and DC resistance of L1 before assembly of the board. Any large discrepancies in values should be electrically simulated in WEBENCH to check for instabilities and thermally simulated in WebTHERM to make sure critical temperatures are not exceeded.

Soldering Component to Board

If board assembly is done in house it is best to tack down one terminal of a component on the board then solder the other terminal. For surface mount parts with large tabs, such as the DPAK, the tab on the back of the package should be pre-tinned with solder, then tacked into place by one of the pins. To solder the tab down to the board place the iron down on the board while resting against the tab, heating both surfaces simultaneously. Apply light pressure to the top of the plastic case until the solder flows around the part and the part is flush with the PCB. If the solder is not flowing around the board you may need a higher wattage iron (generally 25W to 30W is enough).

Initial Startup of Circuit

It is best to initially power up the board by setting the input supply voltage to the lowest operating input voltage 90.0V and set the input supply's current limit to zero. With the input supply off connect up the input supply to V_{in} and GND. Connect a digital volt meter and a load if needed to set the minimum load of the design from V_{out} and GND. Turn on the input supply and slowly turn up the current limit on the input supply. If the voltage starts to rise on the input supply continue increasing the input supply current limit while watching the output voltage. If the current increases on the input supply, but the voltage remains near zero, then there may be a short or a component misplaced on the board. Power down the board and visually inspect for solder bridges and recheck the diode and capacitor polarities. Once the power supply circuit is operational then more extensive testing may include full load testing, transient load and line tests to compare with simulation results.

Load Testing

The setup is the same as the initial startup, except that an additional digital voltmeter is connected between V_{in} and GND, a load is connected between V_{out} and GND and a current meter is connected in series between V_{out} and the load. The load must be able to handle at least rated output power + 50% (7.5 watts for this design). Ideally the load is supplied in the form of a variable load test unit. It can also be done in the form of suitably large power resistors. When using an oscilloscope to measure waveforms on the prototype board, the ground leads of the oscilloscope probes should be as short as possible and the area of the loop formed by the ground lead should be kept to a minimum. This will help reduce ground lead inductance and eliminate EMI noise that is not actually present in the circuit.

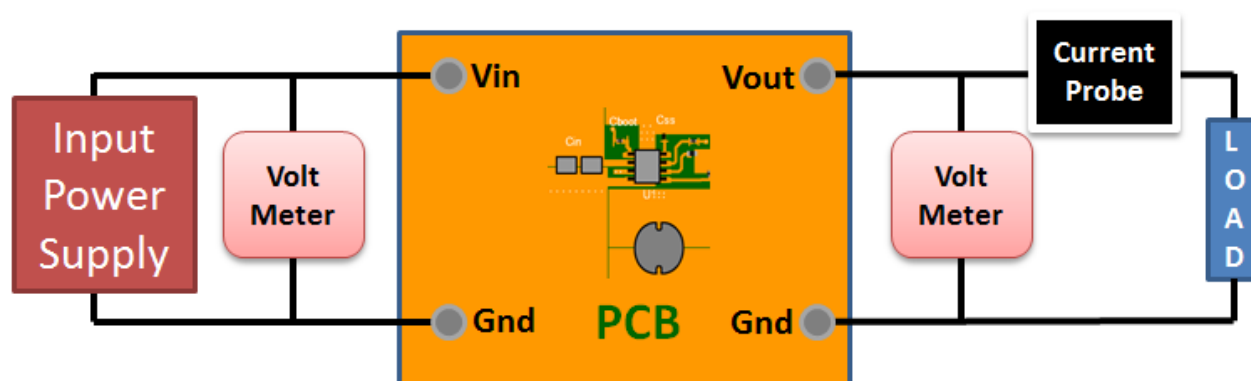

WEBENCH® Transformer Report

#	Name	Value
1.	Core Part Number	B66421G0000X197
2.	Core Manufacturer	TDK
3.	Coil Former Part Number	B66422W1010D001
4.	Coil Former Manufacturer	TDK

Transformer Electrical Diagram

Primary

Turns	38.0
AWG	28.0
Layers	2.0
Strands	2.0
Insulation Type	Heavy Insulated Magnet Wire

Secondary

Turns	8.0
AWG	28.0
Layers	1.0
Strands	3.0
Insulation Type	Triple Insulated

Auxiliary

Turns	8.0
AWG	28.0
Layers	1.0
Strands	4.0
Insulation Type	Heavy Insulated Magnet Wire

Transformer Construction Diagram

Winding Instruction

Winding	AWG	Turns	Winding Orientation
Primary First 1/2.0	28.0	19	Clockwise
Triple Insulated Secondary	28.0	8.0	Counter Clockwise
Auxiliary	28.0	8.0	Counter Clockwise
Primary Second 1/2.0	28.0	19	Clockwise

Transformer Parameters

#	Name	Value
1.	Lpri	1.76E-4H
2.	Inductance Factor(AI)	122.0nH
3.	Npri	38.0
4.	Nsec	8.0
5.	Naux	8.0
6.	Core Type	EFD25/13/9
7.	Core Material	N97

#	Name	Value
8.	Bmax	0.20T
9.	Switching Frequency	100.00kHz
10.	DMax	0.48
11.	Ipk(Primary)	2.46A
12.	Irms(Primary)	0.98A
13.	Ipk(Secondary)	11.7A
14.	Irms(Secondary)	4.4A

Design Assistance

1. Application Hints Rbld Rdd is set to 22 Ohms by default. it can be varied between 1 Ohm to 47 Ohms depending on transformer selected and Vdd expected Rg1 is set to 10 Ohms by default, it can be adjusted according to mosfet selected Rbld is used to set a minimum load for the circuit, so that in standby the output voltage does not float up. The value chosen by WEBENCH should be a good starting point but may need to be adjusted to achieve minimum power dissipation at standby as well. Rlc Rlc provides the function of feed-forward line compensation to eliminate change in IPP due to change in di/dt and the propagation delay of the internal comparator and MOSFET turn-off time. For best results the chosen value may need to be adjusted based on board, FET and transformer parasitics. Rfbt & Rfbb The feedback resistors will set the output voltage of the circuit. The values chosen may need to be fined tuned based on the final Transformer turns ratios and the voltage across the output diode at close to zero current. Cdd Cdd supplies the device operating current until the output of the converter reaches the target minimum operating voltage. The value calculated by WEBENCH for Cdd is a good starting point since it assumes that the output current of the Flyback is available to charge the output capacitance until the minimum output voltage is acheived, but may need to be adjusted. Part Description The UCC28700 family of flyback power supply controllers provides Constant-Voltage (CV) and Constant-Current (CC) output regulation. Primary-Side Regulation (PSR) eliminates the use of an Opto-Coupler. Please see the datasheet for further design guidance(For non Q1 parts). <http://www.ti.com/lit/ds/symlink/ucc28700.pdf>For non Q1 parts<http://www.ti.com/lit/ds/symlink/ucc28700-q1.pdf>

2. Master key : D79F83290EB04BD5[v1]

3. **UCC28701** Product Folder : <http://www.ti.com/product/UCC28701> : contains the data sheet and other resources.

Important Notice and Disclaimer

TI provides technical and reliability data (including datasheets), design resources (including reference designs), application or other design advice, web tools, safety information, and other resources AS IS and with all faults, and disclaims all warranties. These resources are intended for skilled developers designing with TI products. You are solely responsible for (1) selecting the appropriate TI products for your application, (2) designing, validating and testing your application, and (3) ensuring your application meets applicable standards, and any other safety, security, or other requirements.

These resources are subject to change without notice. TI grants you permission to use these resources only for development of an application that uses the TI products described in the resource. Other reproduction and display of these resources is prohibited. No license is granted to any other TI intellectual property right or to any third party intellectual property right. TI disclaims responsibility for, and you will fully indemnify TI and its representatives against, any claims, damages, costs, losses, and liabilities arising out of your use of these resources.

Providing these resources does not expand or otherwise alter TI's applicable Terms of Sale or other applicable terms available either on ti.com or provided in conjunction with TI products.