

# AFE

# Onboard Thermistors

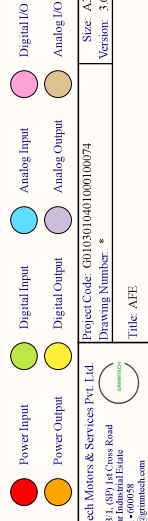
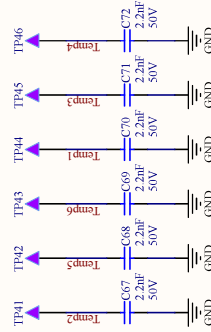
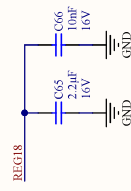
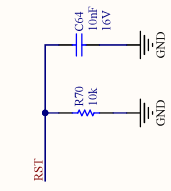
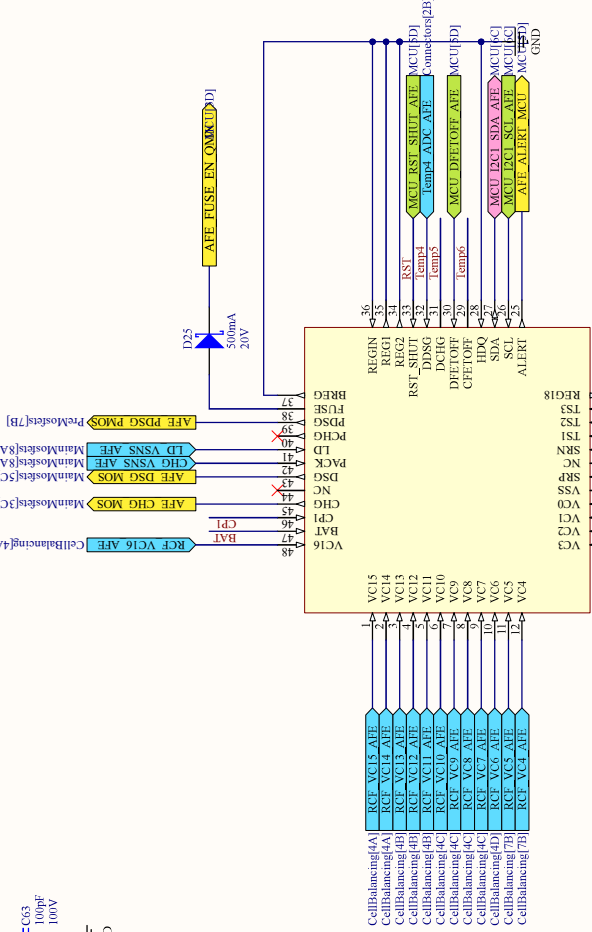
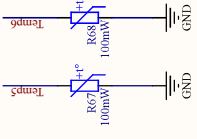
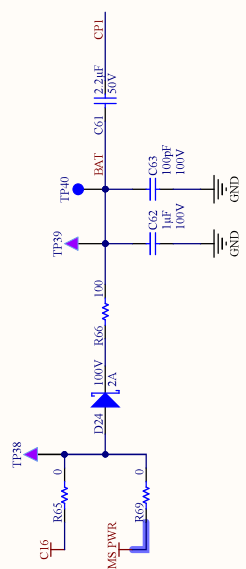

Project Code: G0103010401000100074  
 Drawing Number: \*  
 Title: AFE  
 Size: A3  
 Version: 3.0

Grimtech Motors & Services Pvt. Ltd.  
 No-11B/1, 89/1st Cross Road  
 Anantpur Industrial Estate  
 Anantpur, Karnataka  
 contact@grimtech.com

Issue	Date	CR#	ER#	Checked By
*	*	*	*	Vary Prapant
Details				
Drawn By				
Checked By				
Ink/Sheet No.				

File Name: AFE\_SchDoc  
 Printed: 9/9/2024  
 Sheet 10 of 19

# CellBalancing

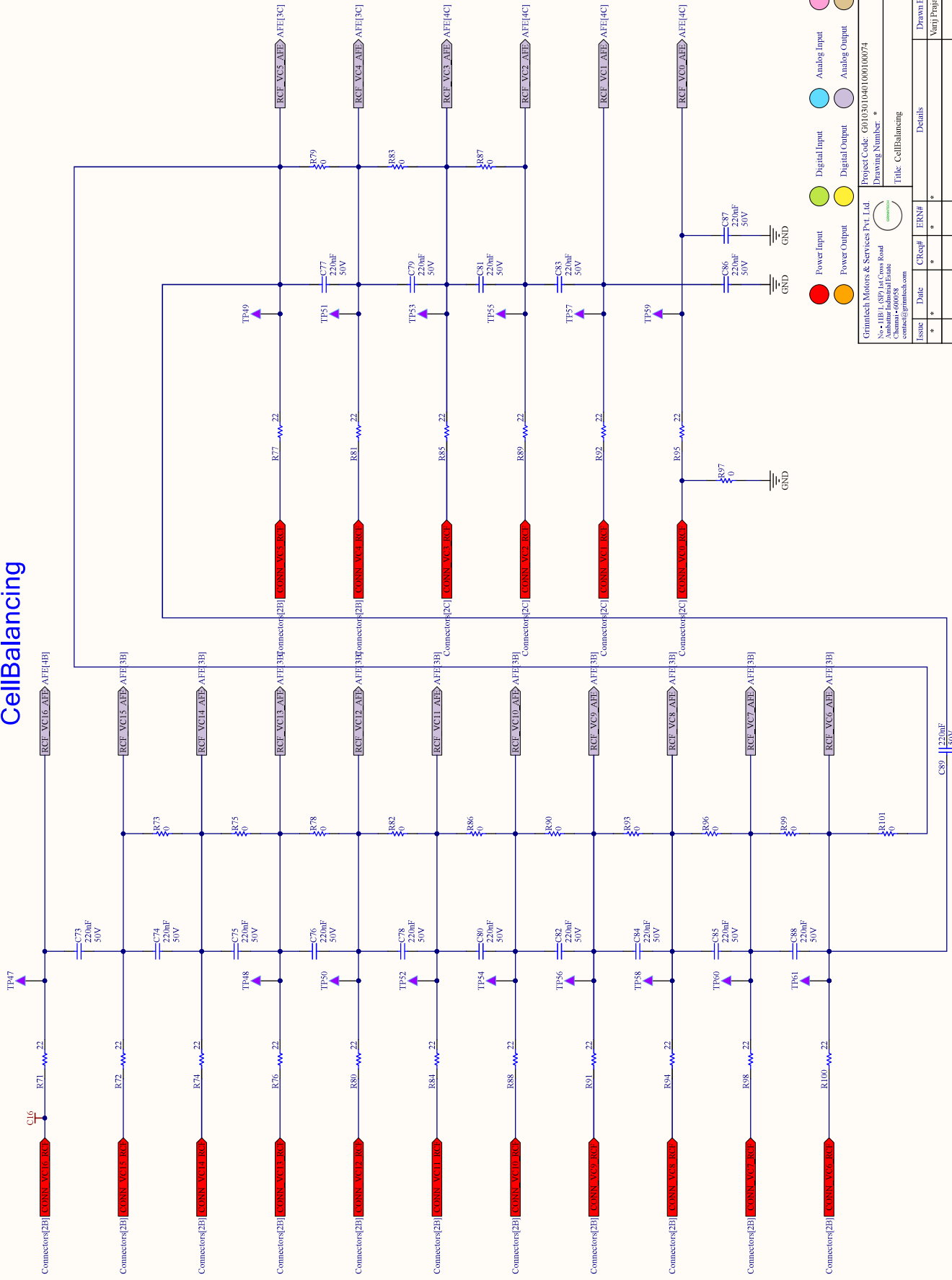

● Power Input    ● Digital Input    ● Analog Input    ● Digital I/O  
● Power Output    ● Digital Output    ● Analog Output    ● Analog I/O

Project Code: G0103010401000100074    Size: A3  
 Drawing Number: \*    Version: 3.0  
 Title: CellBalancing

Issue	Date	CTRef#	ERN#	Drawn By	Checked By
*	*	*	*	Vary Pranshu	Nikhil Mishra

File Name: CellBalancing\_SchDoc    Printed: 9/9/2024    Sheet 11 of 19