

1

2

3

4

1

2

3

4

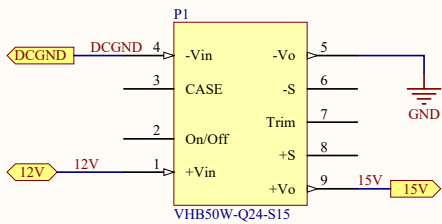
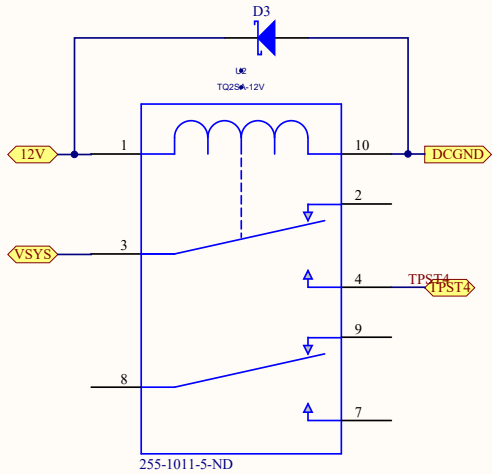

Charger Power

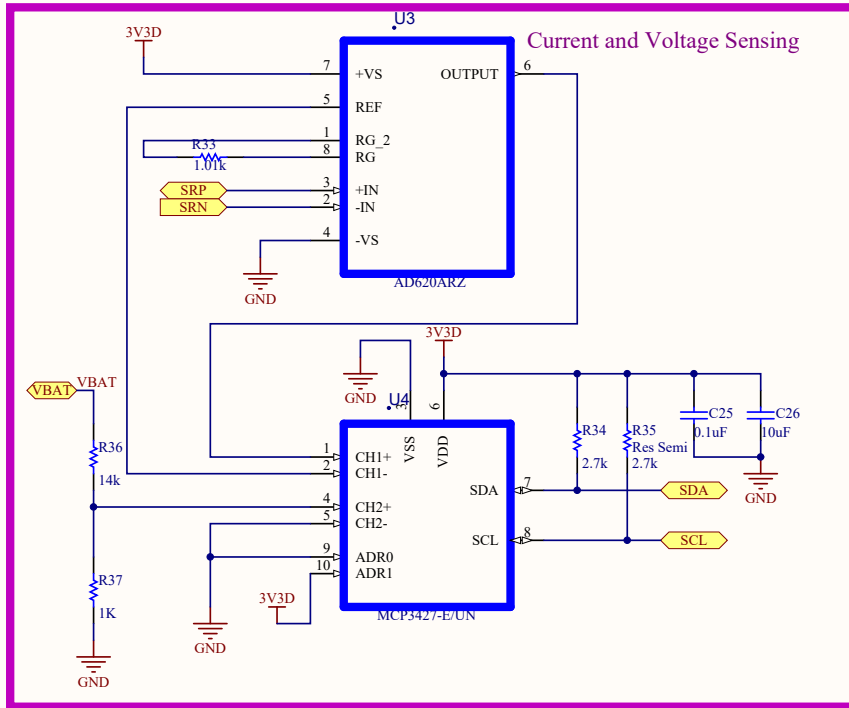
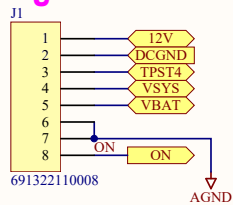

To Interface Board

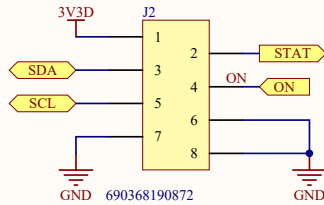

Title		
Size	Number	Revision
A4		
Date:	20-Sep-17	Sheet of
File:	C:\Users\Mini\Mini Charger Sensor.SchDoc	Drawn By:

1

2

3

4

A

A

B

B

C

C

D

D

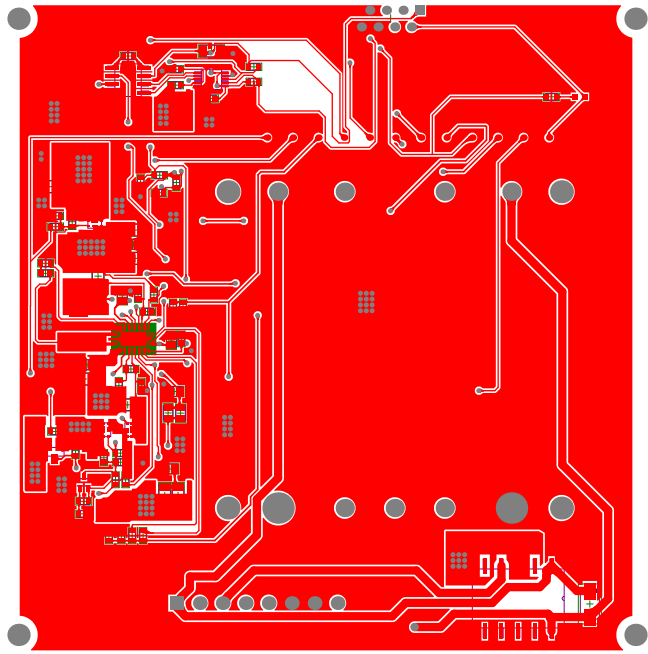

Altium Limited
 12a Rodborough Rd
 Frenchs Forest
 NSW 2086

ENGINEER:	TITLE:		
PCB DESIGNER:			
DATE: 20-Sep-17	PART NO.:	REV:	
FILE NAME: Charger-1-0-A.PcbDoc	DWG NO.:	SCALE:	

1

2

3

4

1

2

3

4

A

A

B

B

C

C

D

D

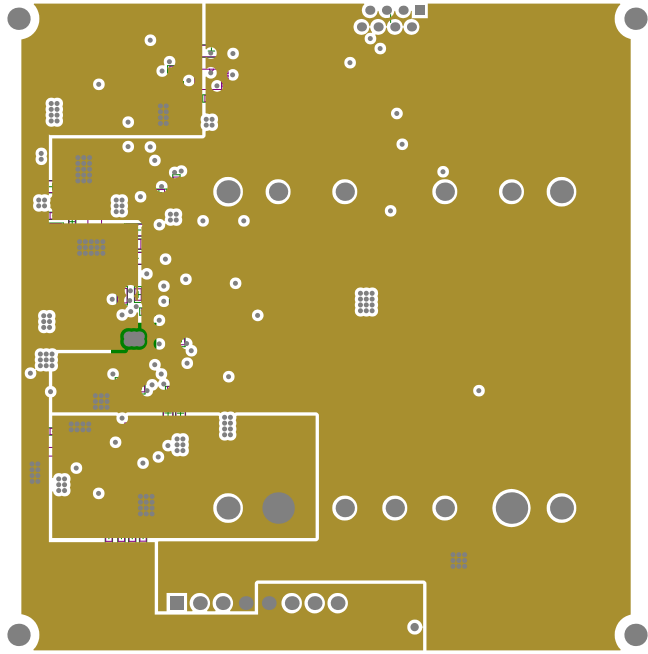

 <p>Altium Limited 12a Rodborough Rd Frenchs Forest NSW 2086</p>	ENGINEER:	TITLE:	
	PCB DESIGNER:		
	DATE: 20-Sep-17	PART NO.:	REV.:
	FILE NAME: Charger-1-0-A.PcbDoc	DWG NO.:	SCALE:

1

2

3

4

1

2

3

4

A

A

B

B

C

C

D

D

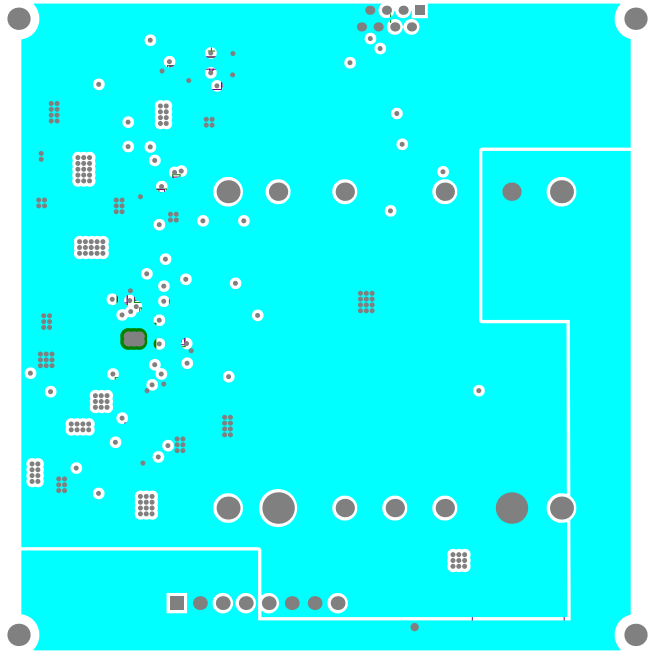

 <p>Altium Limited 12a Rodborough Rd Frenchs Forest NSW 2086</p>	ENGINEER:	TITLE:	
	PCB DESIGNER:		
DATE: 20-Sep-17	PART NO.:	REV.:	
FILE NAME: Charger-1-0-A.PcbDoc	DWG NO.:	SCALE:	

1

2

3

4

1

2

3

4

A

A

B

B

C

C

D

D

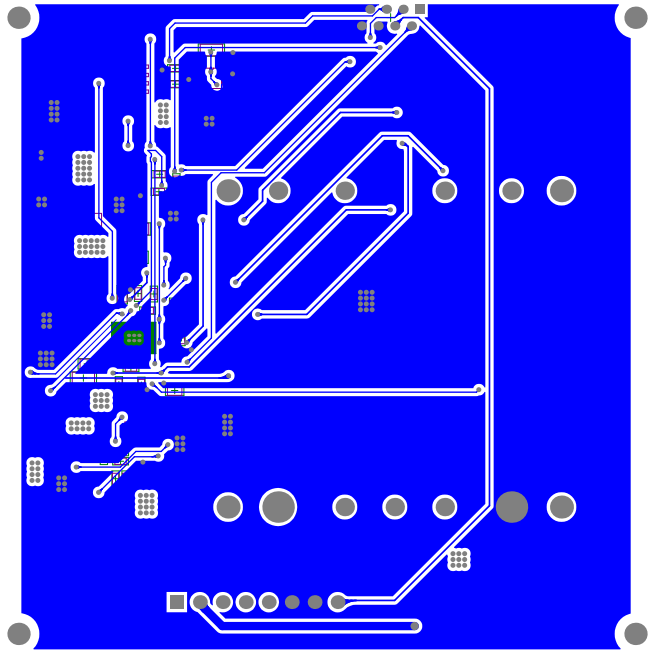

 <p>Altium Limited 12a Rodborough Rd Frenchs Forest NSW 2086</p>	ENGINEER:	TITLE:	
	PCB DESIGNER:		
	DATE: 20-Sep-17	PART NO.:	REV.:
	FILE NAME: Charger-1-0-A.PcbDoc	DWG NO.:	SCALE:

1

2

3

4

1

2

3

4

A

A

B

B

C

C

D

D

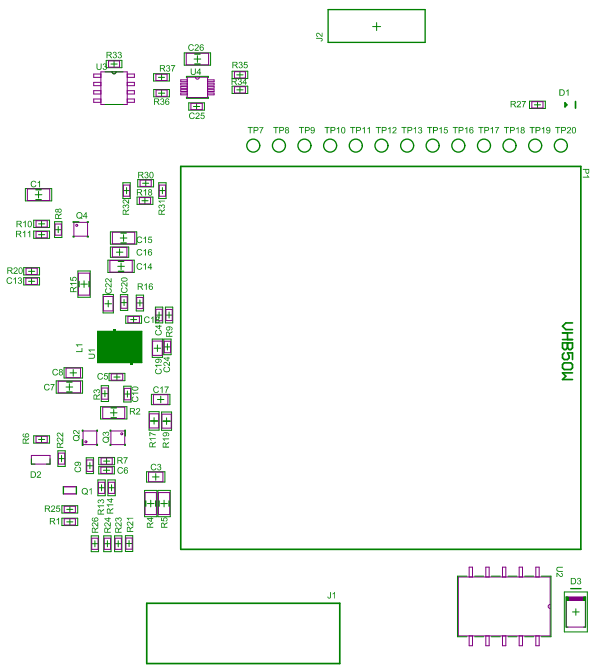

Altium Limited
12a Rodborough Rd
Frenchs Forest
NSW 2086

ENGINEER:	TITLE:		
PCB DESIGNER:	PART NO.:		
DATE: 20-Sep-17	REV:		SCALE:
FILE NAME: Charger-1-0-A.PcbDoc	DWG NO.:		SCALE:

1

2

3

4

1

2

3

4

A

A

B

B

C

C

D

D

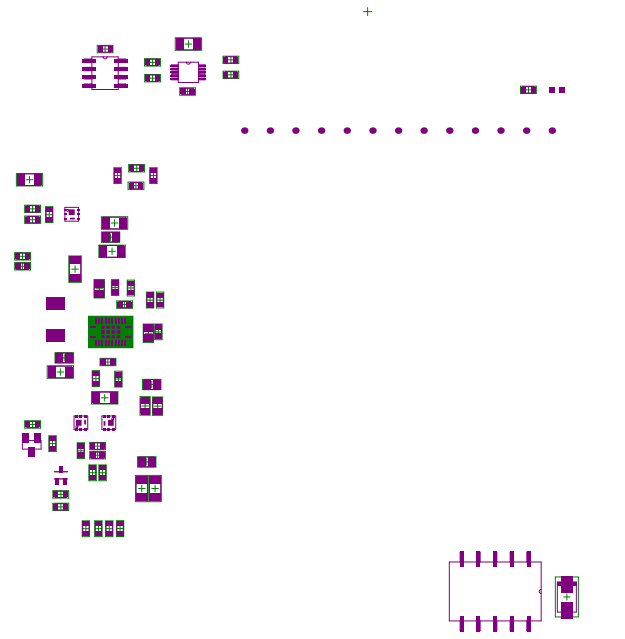

 <p>Altium Limited 12a Rodborough Rd Frenchs Forest NSW 2086</p>	ENGINEER:	TITLE:	
	PCB DESIGNER:		
DATE: 20-Sep-17	PART NO.:	REV:	
FILE NAME: Charger-1-0-A.PcbDoc	DWG NO.:	SCALE:	

1

2

3

4

1

2

3

4

A

A

B

B

C

C

D

D

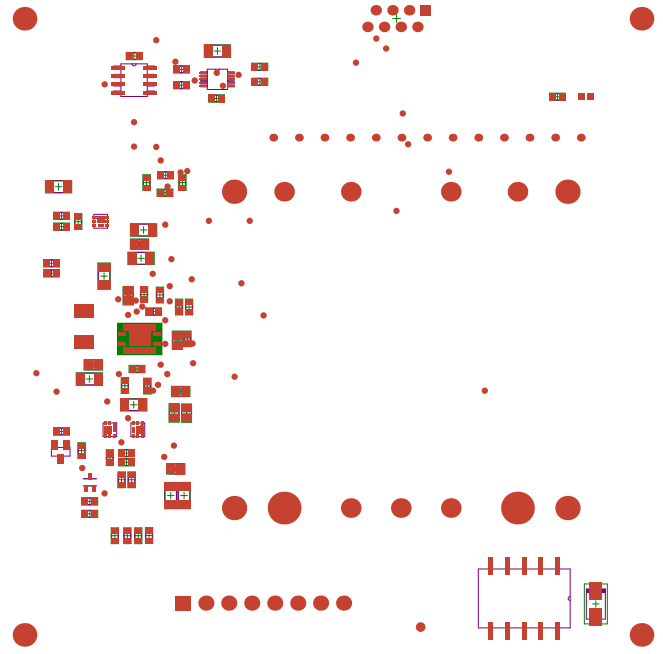

 <p>Altium Limited 12a Rodborough Rd Frenchs Forest NSW 2086</p>	ENGINEER:	TITLE:	
	PCB DESIGNER:		
DATE: 20-Sep-17	PART NO.:	REV:	
FILE NAME: Charger-1-0-A.PcbDoc	DWG NO.:	SCALE:	

1

2

3

4

1

2

3

4

A

A

B

B

C

C

D

D

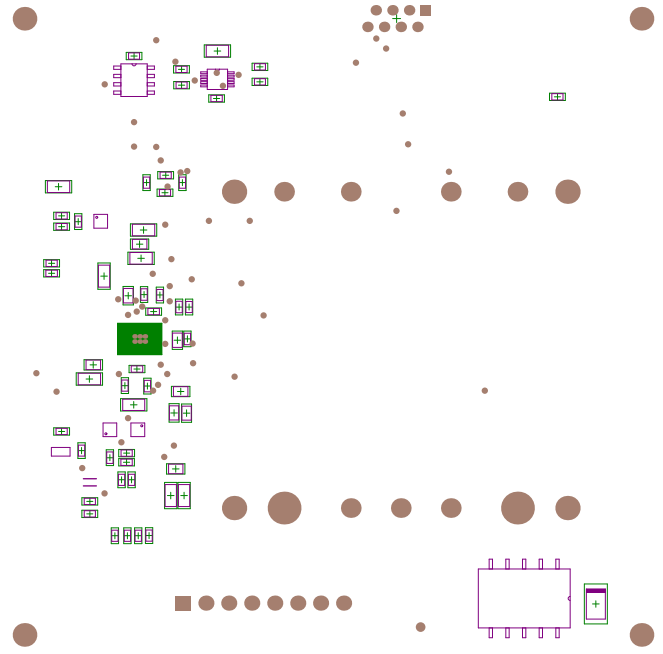

 <p>Altium Limited 12a Rodborough Rd Frenchs Forest NSW 2086</p>	ENGINEER:	TITLE:	
	PCB DESIGNER:		
DATE: 20-Sep-17	PART NO.:	REV:	
FILE NAME: Charger-1-0-A.PcbDoc	DWG NO.:	SCALE:	

1

2

3

4

1

2

3

4

A

A

B

B

C

C

D

D

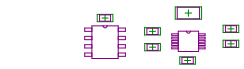

+

+

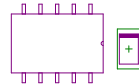
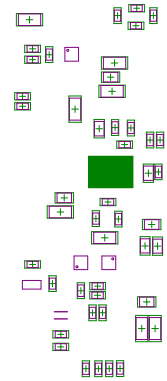

Altium Limited
 12a Rodborough Rd
 Frenchs Forest
 NSW 2086

ENGINEER:	TITLE:		
PCB DESIGNER:	PART NO.:		
DATE: 20-Sep-17	REV:		SCALE:
FILE NAME: Charger-1-0-A.PcbDoc	DWG NO.:		SCALE:

1

2

3

4

1

2

3

4

A

A

B

B

C

C

D

D

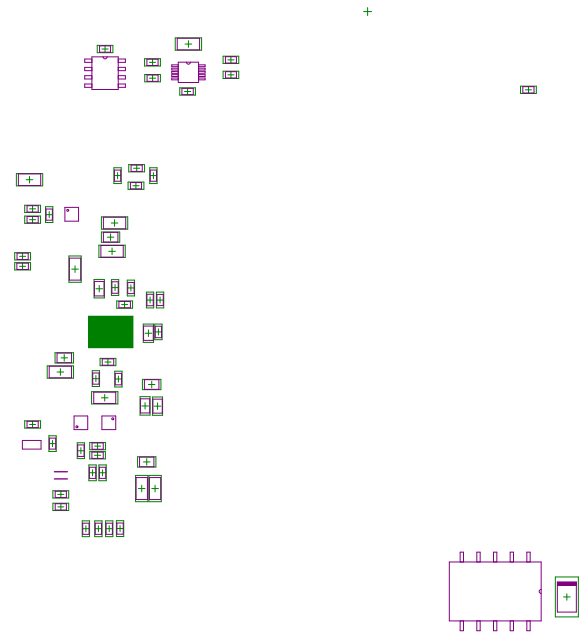

 <p>Altium Limited 12a Rodborough Rd Frenchs Forest NSW 2086</p>	ENGINEER:	TITLE:	
	PCB DESIGNER:		
DATE: 20-Sep-17	PART NO.:	REV:	
FILE NAME: Charger-1-0-A.PcbDoc	DWG NO.:	SCALE:	

1

2

3

4

1

2

3

4

A

A

B

B

C

C

D

D

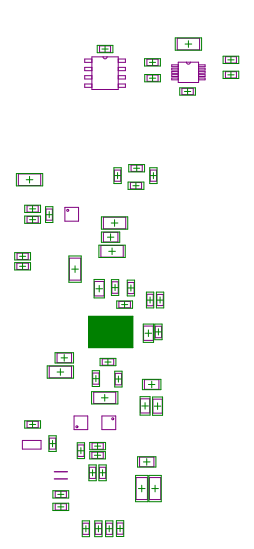

+

+

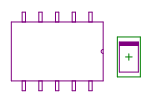

Altium Limited
12a Rodborough Rd
Frenchs Forest
NSW 2086

ENGINEER:	TITLE:		
PCB DESIGNER:	PART NO.:		
DATE: 20-Sep-17	REV:		SCALE:
FILE NAME: Charger-1-0-A.PcbDoc	DWG NO.:		SCALE:

1

2

3

4

1

2

3

4

A

A

B

B

C

C

D

D

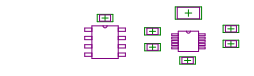

+

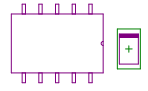
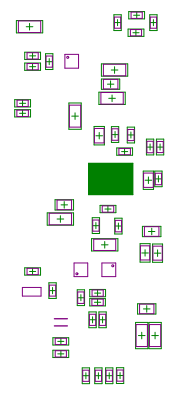

Altium Limited
 12a Rodborough Rd
 Frenchs Forest
 NSW 2086

ENGINEER:	TITLE:		
PCB DESIGNER:	PART NO.:		
DATE: 20-Sep-17	REV:		SCALE:
FILE NAME: Charger-1-0-A.PcbDoc	DWG NO.:		SCALE:

1

2

3

4

1

2

3

4

A

A

B

B

C

C

D

D

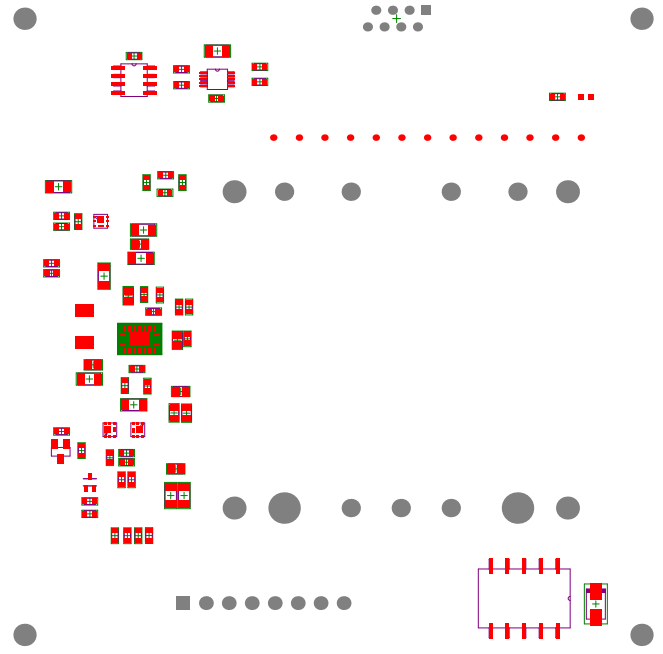

 <p>Altium Limited 12a Rodborough Rd Frenchs Forest NSW 2086</p>	ENGINEER:	TITLE:	
	PCB DESIGNER:		
DATE: 20-Sep-17	PART NO.:	REV:	
FILE NAME: Charger-1-0-A.PcbDoc	DWG NO.:	SCALE:	

1

2

3

4

1

2

3

4

A

A

B

B

C

C

D

D

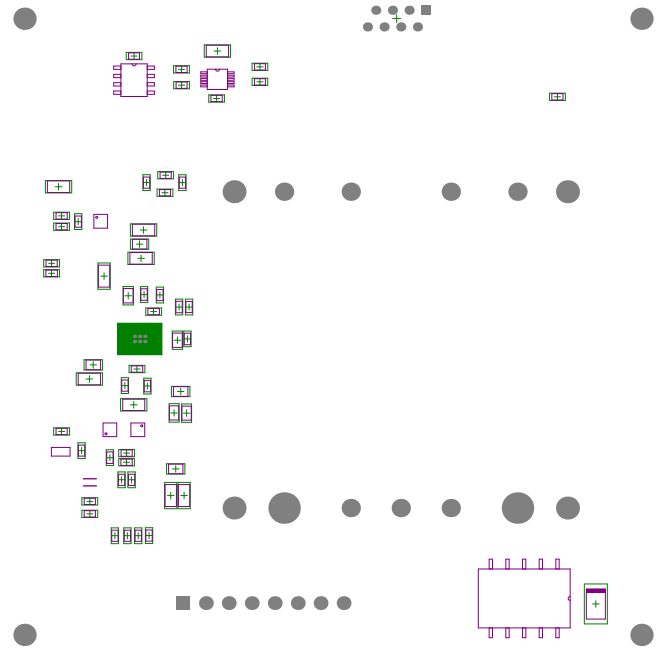

 <p>Altium Limited 12a Rodborough Rd Frenchs Forest NSW 2086</p>	ENGINEER:	TITLE:	
	PCB DESIGNER:		
DATE: 20-Sep-17	PART NO.:	REV:	
FILE NAME: Charger-1-0-A.PcbDoc	DWG NO.:	SCALE:	

1

2

3

4

1

2

3

4

A

A

B

B

C

C

D

D

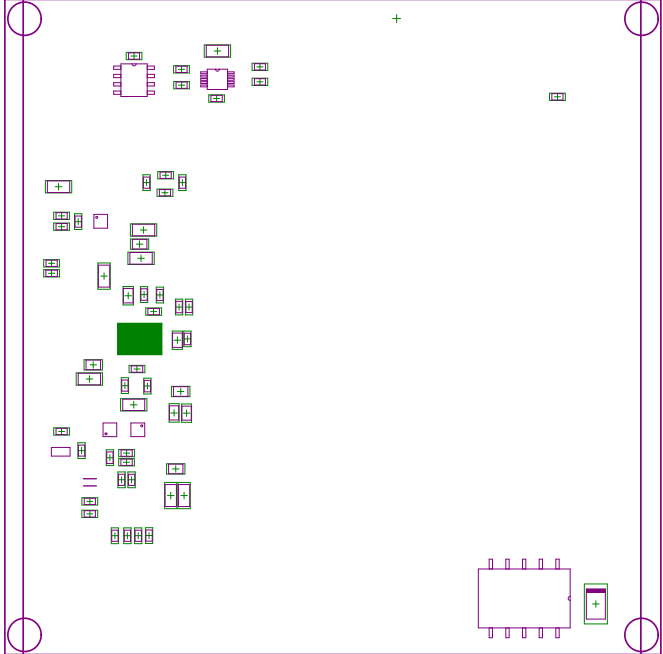

Altium Limited
 12a Rodborough Rd
 Frenchs Forest
 NSW 2086

ENGINEER:	TITLE:		
PCB DESIGNER:	PART NO.:		
DATE: 20-Sep-17	REV:		SCALE:
FILE NAME: Charger-1-0-A.PcbDoc	DWG NO.:		SCALE:

1

2

3

4

1

2

3

4

A

A

B

B

C

C

D

D

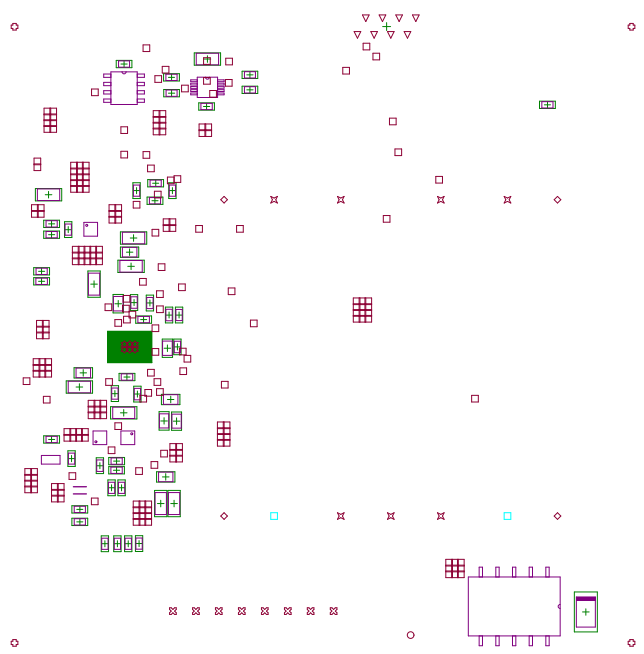

Altium Limited
 12a Rodborough Rd
 Frenchs Forest
 NSW 2086

ENGINEER:	TITLE:		
PCB DESIGNER:	PART NO.:		
DATE: 20-Sep-17	DWG NO.:		REV.:
FILE NAME: Charger-1-0-A.PcbDoc	SCALE:		

1

2

3

4

1

2

3

4

A

A

B

B

C

C

D

D

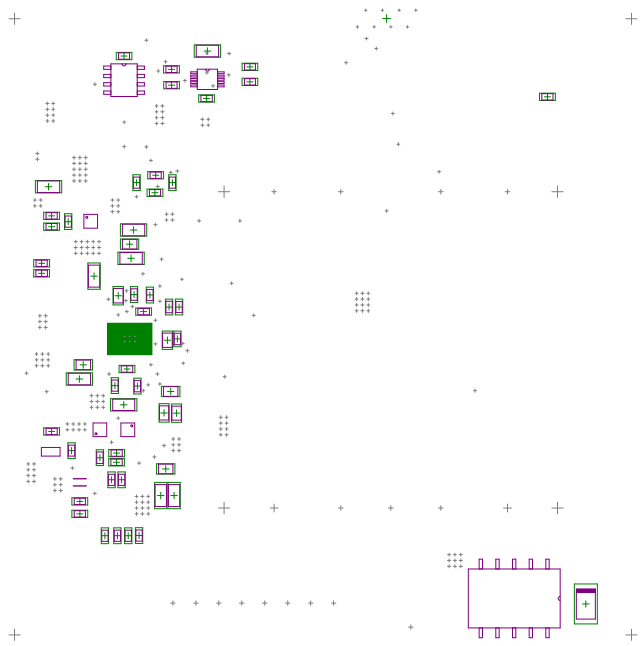

 <p>Altium Limited 12a Rodborough Rd Frenchs Forest NSW 2086</p>	ENGINEER:	TITLE:	
	PCB DESIGNER:		
DATE: 20-Sep-17	PART NO.:	REV:	
FILE NAME: Charger-1-0-A.PcbDoc	DWG NO.:	SCALE:	

1

2

3

4