

# LED DRIVING SCHEME

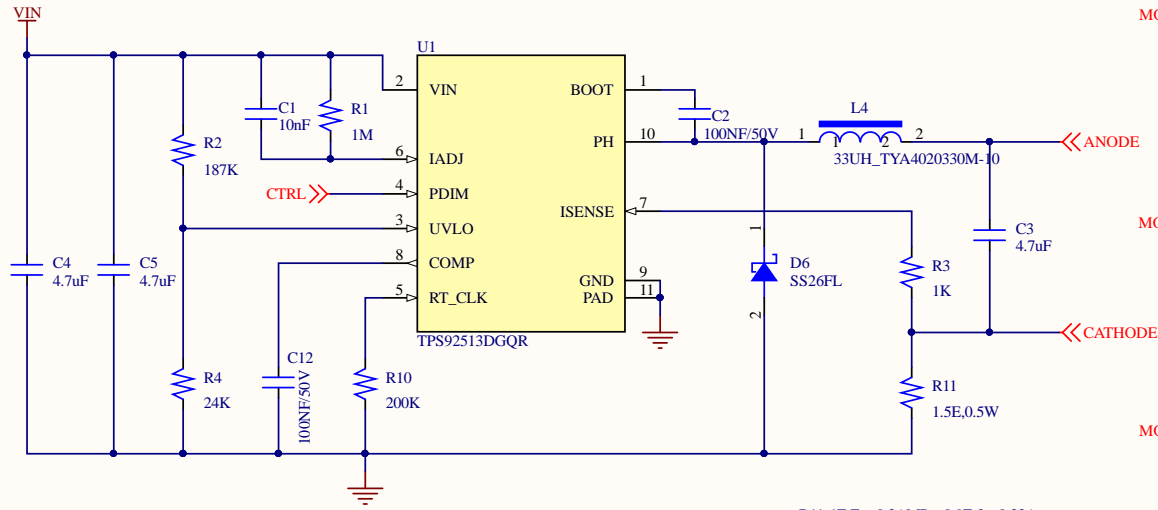

R11-1E For 0.3AMP, 0.9E for 0.33A

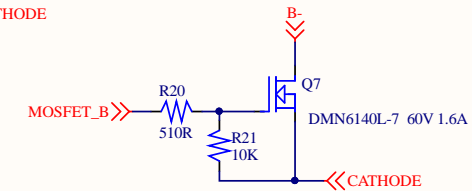
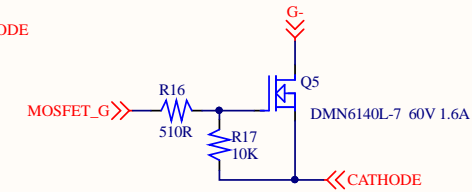
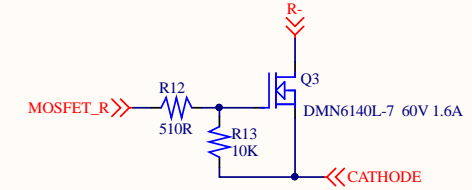
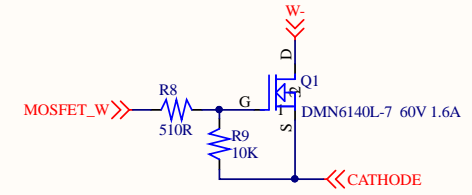
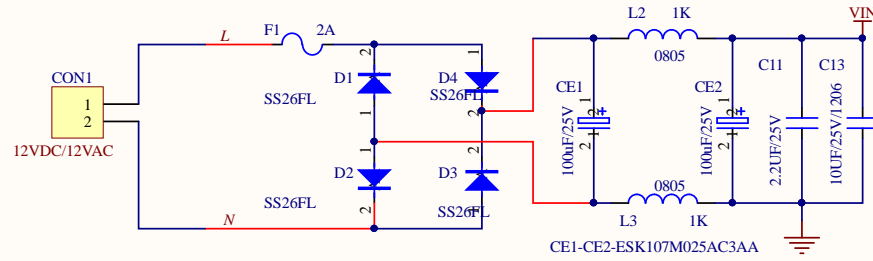
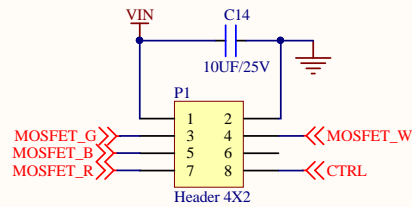

To BLE Module

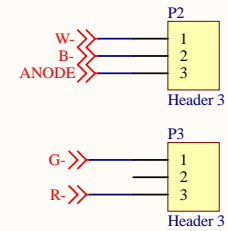

To LED Module

MeshTek Labs 17330 Preston Rd., Ste. 140A, Dallas, TX 75252, USA			
Title			
Size	Document Number	Rev	
A	Sch_G4 Bipin-Driver	V1.0	
Date:	Sheet 1 of 1		

Comment	Description	Designator	Footprint	LibRef	Quantity
---------	-------------	------------	-----------	--------	----------