

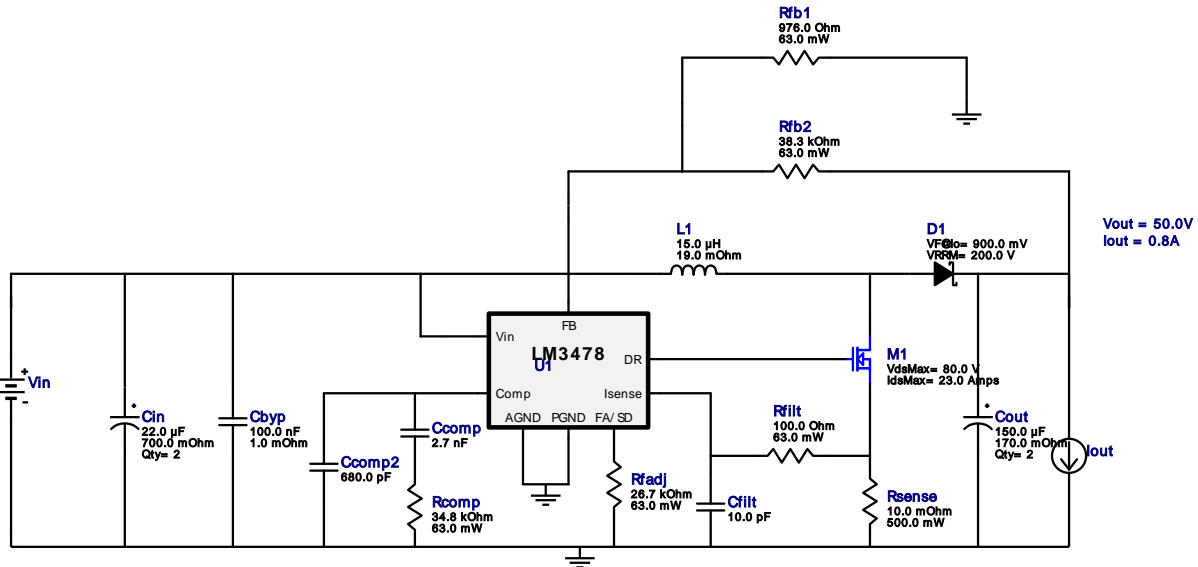



WEBENCH® Design Report

 Design : 16 LM3478MMX/NOPB
 LM3478MMX/NOPB 11V-13V to 50.00V @ 0.8A

1. With the low turn of voltage of the LM34x8 your power supply may current limit before you reach your working input voltage. If this happens, or to preempt this from happening, you can include a low pass RC filter from input voltage to Vin on the IC. Make sure the rise time on the RC network is slower than your supply's rise time.

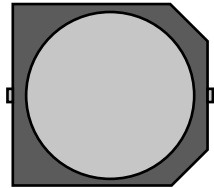
Electrical BOM

Name	Manufacturer	Part Number	Properties	Qty	Price	Footprint
Cbyp	MuRata	GRM155R71C104KA88D Series= X7R	Cap= 100.0 nF ESR= 1.0 mOhm VDC= 16.0 V IRMS= 0.0 A	1	\$0.01	0402 3 mm ²
Ccomp	TDK	C2012C0G1H272J060AA Series= C0G/NP0	Cap= 2.7 nF VDC= 50.0 V IRMS= 0.0 A	1	\$0.03	0805 7 mm ²
Ccomp2	Samsung Electro-Mechanics	CL05C681JB5NNNC Series= C0G/NP0	Cap= 680.0 pF VDC= 50.0 V IRMS= 0.0 A	1	\$0.01	0402 3 mm ²
Cfilt	Samsung Electro-Mechanics	CL21C100JBANNNC Series= C0G/NP0	Cap= 10.0 pF VDC= 50.0 V IRMS= 0.0 A	1	\$0.01	0805 7 mm ²
Cin	Panasonic	EEE-FK1V220R Series= FK	Cap= 22.0 uF ESR= 700.0 mOhm VDC= 35.0 V IRMS= 160.0 mA	2	\$0.09	 SM_RADIAL_C 62 mm ²
Cout	Panasonic	EEV-FK2A151M Series= FK	Cap= 150.0 uF ESR= 170.0 mOhm VDC= 100.0 V IRMS= 793.0 mA	2	\$0.74	 SM_RADIAL_J16 399 mm ²
D1	SMC Diode Solutions	SK220ATR	VF@Io= 900.0 mV VRRM= 200.0 V	1	\$0.04	 SMA 37 mm ²

Name	Manufacturer	Part Number	Properties	Qty	Price	Footprint
L1	Coilcraft	MSS1210-153MEB	L= 15.0 μ H 19.0 mOhm	1	\$0.81	 MSS1210 204 mm ²
M1	Infineon Technologies	BSC340N08NS3 G	VdsMax= 80.0 V IdsMax= 23.0 Amps	1	\$0.24	 PG-TDSON-8 55 mm ²
Rcomp	Vishay-Dale	CRCW040234K8FKED Series= CRCW..e3	Res= 34.8 kOhm Power= 63.0 mW Tolerance= 1.0%	1	\$0.01	 0402 3 mm ²
Rfadj	Vishay-Dale	CRCW040226K7FKED Series= CRCW..e3	Res= 26.7 kOhm Power= 63.0 mW Tolerance= 1.0%	1	\$0.01	 0402 3 mm ²
Rfb1	Vishay-Dale	CRCW0402976RFKED Series= CRCW..e3	Res= 976.0 Ohm Power= 63.0 mW Tolerance= 1.0%	1	\$0.01	 0402 3 mm ²
Rfb2	Vishay-Dale	CRCW040238K3FKED Series= CRCW..e3	Res= 38.3 kOhm Power= 63.0 mW Tolerance= 1.0%	1	\$0.01	 0402 3 mm ²
Rfilt	Vishay-Dale	CRCW0402100RFKED Series= CRCW..e3	Res= 100.0 Ohm Power= 63.0 mW Tolerance= 1.0%	1	\$0.01	 0402 3 mm ²
Rsense	Stackpole Electronics Inc	CSR1206FK10L0 Series= ?	Res= 10.0 mOhm Power= 500.0 mW Tolerance= 1.0%	1	\$0.12	 1206 11 mm ²
U1	Texas Instruments	LM3478MMX/NOPB	Switcher	1	\$0.73	 MUA08A 24 mm ²

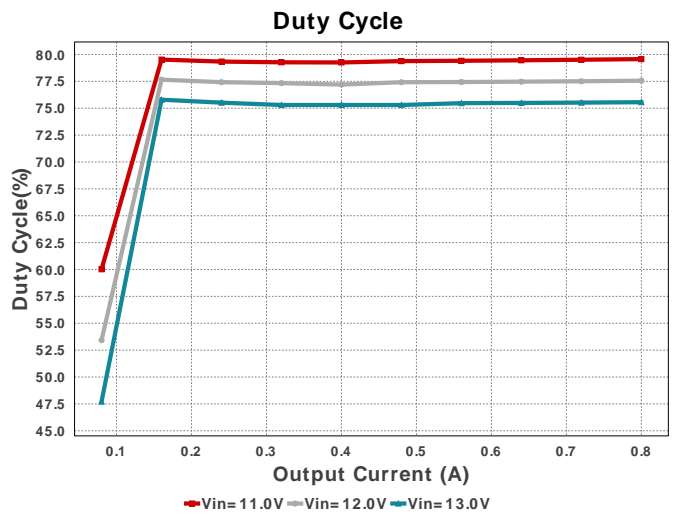
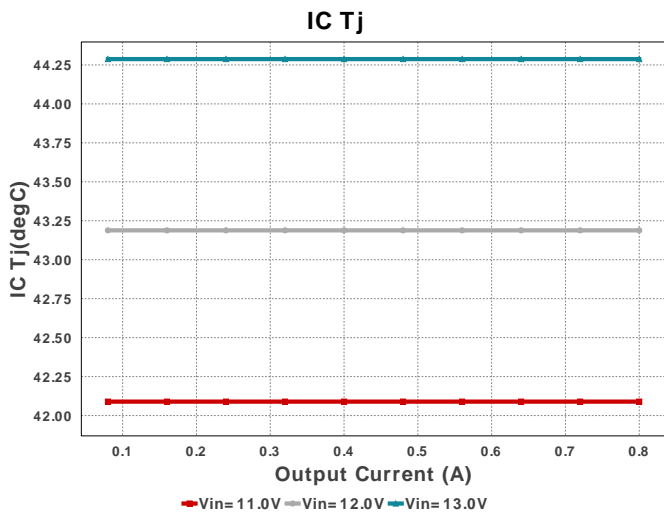

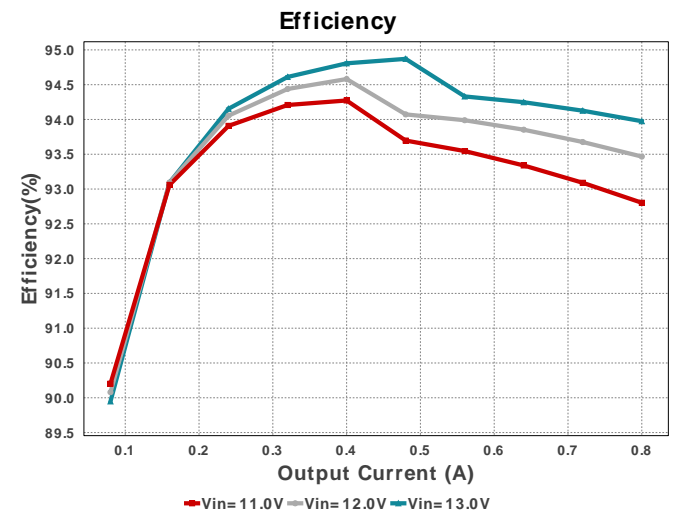
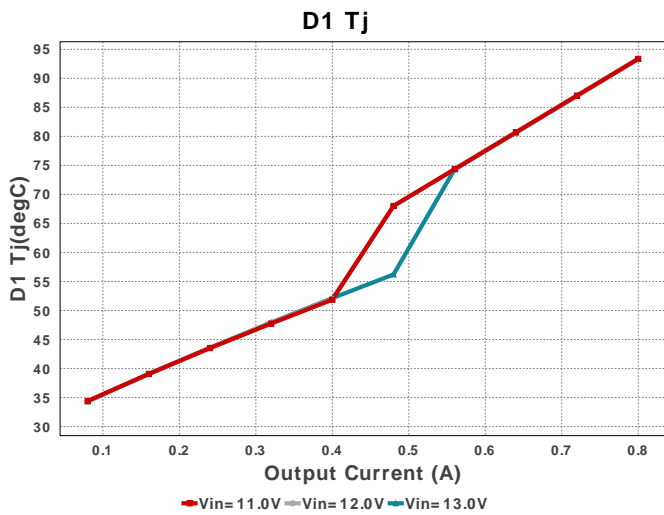
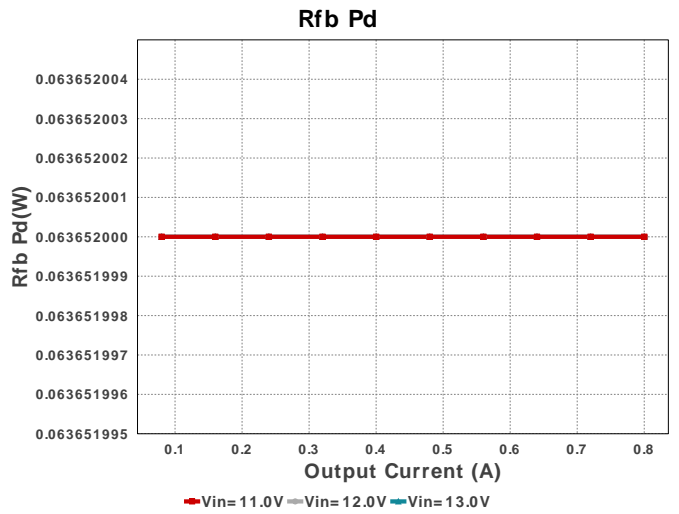
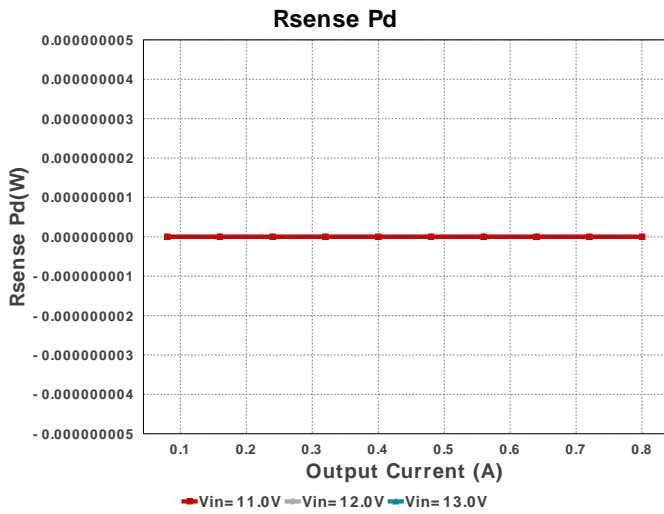
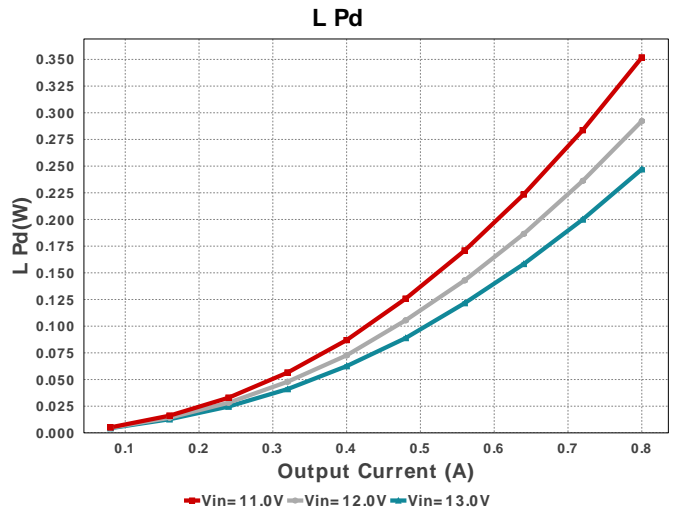
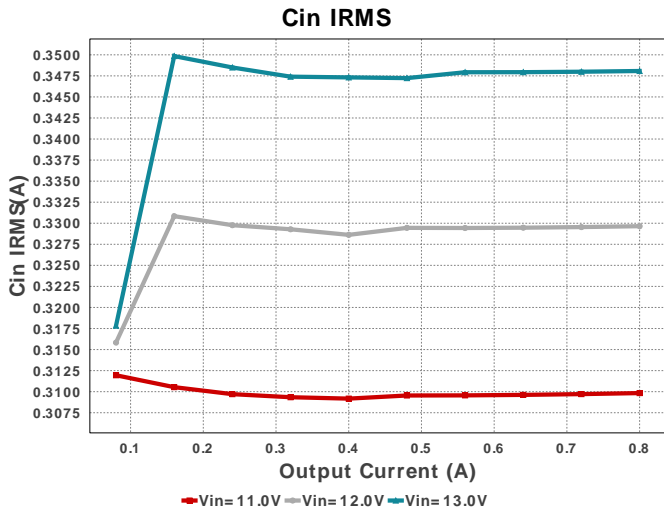

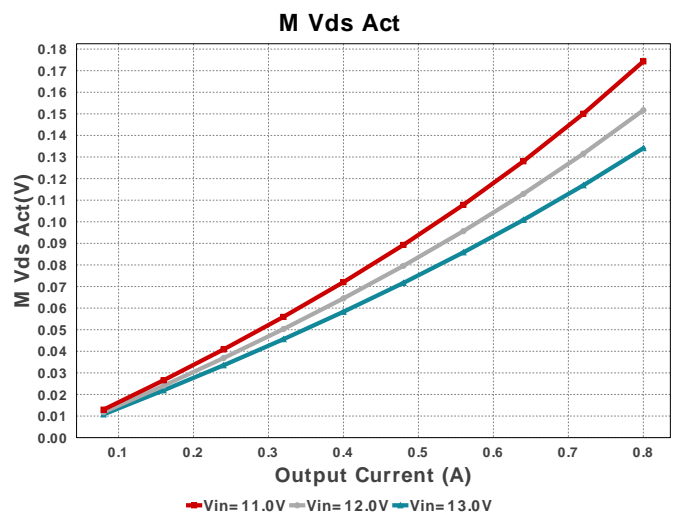
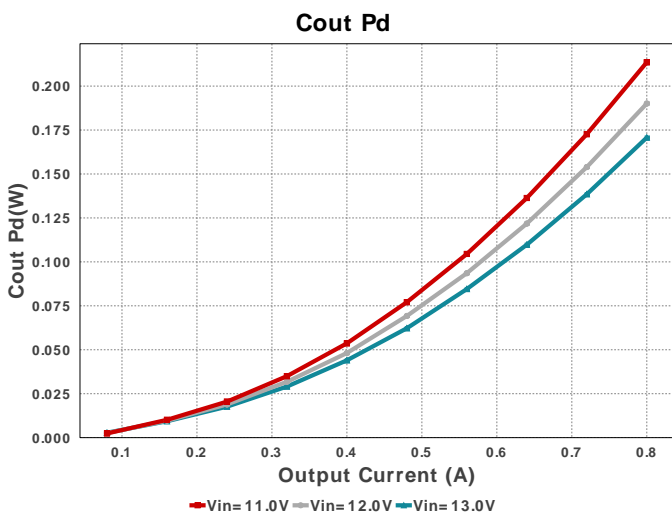
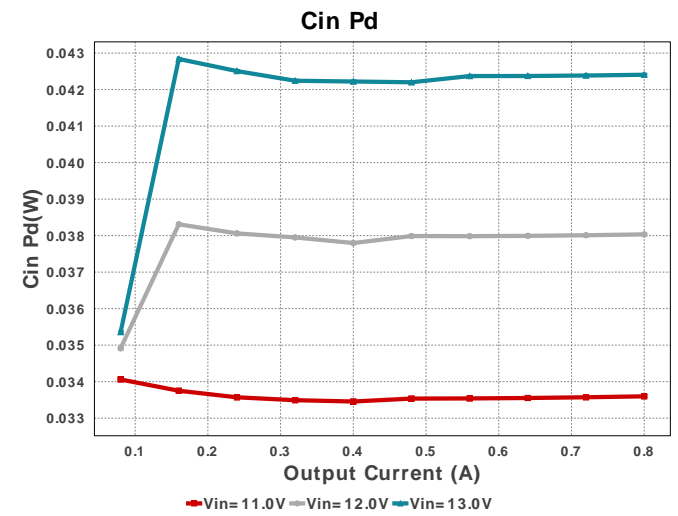
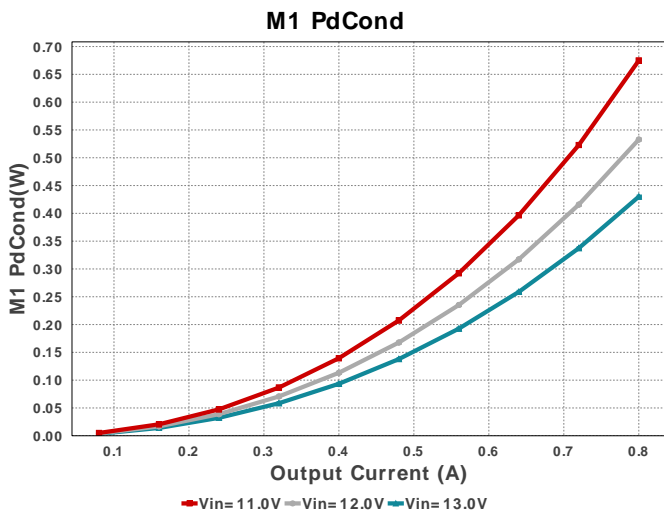
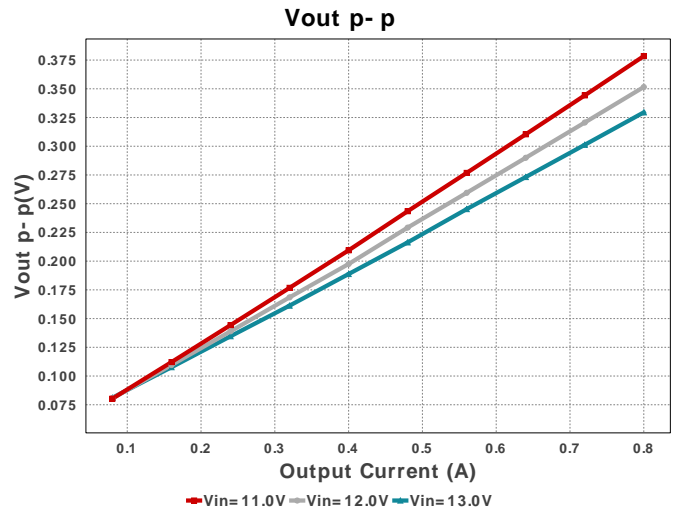
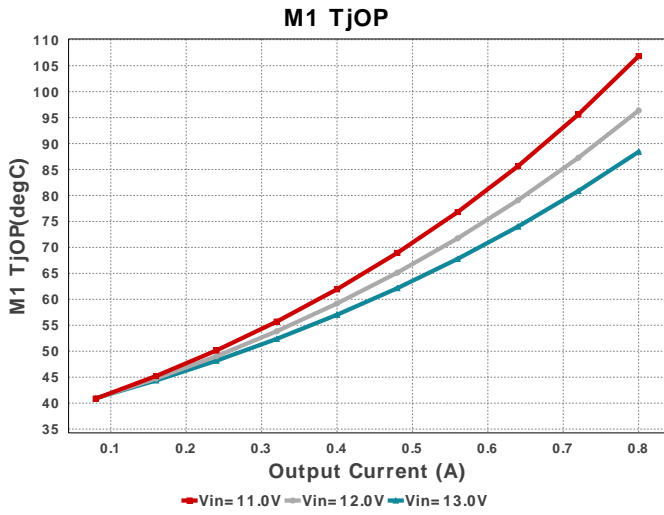

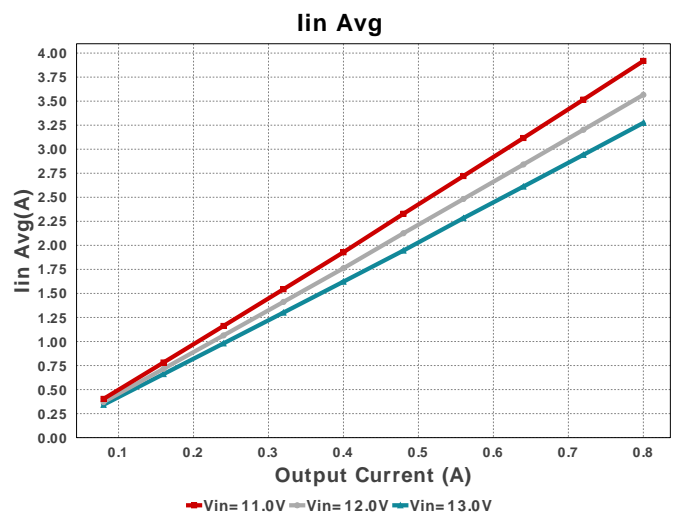
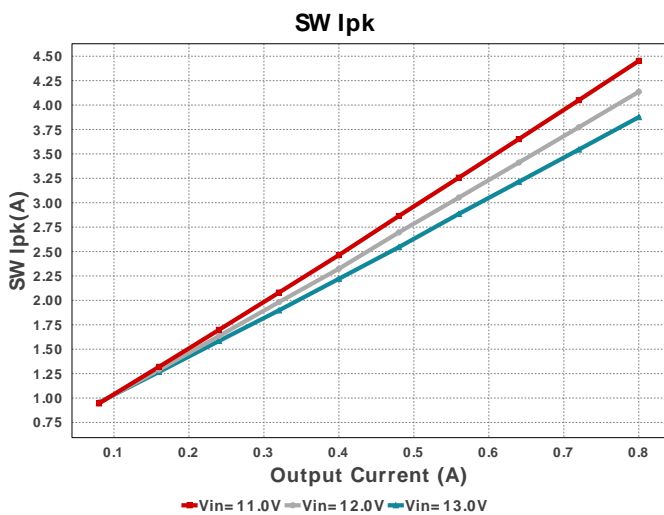
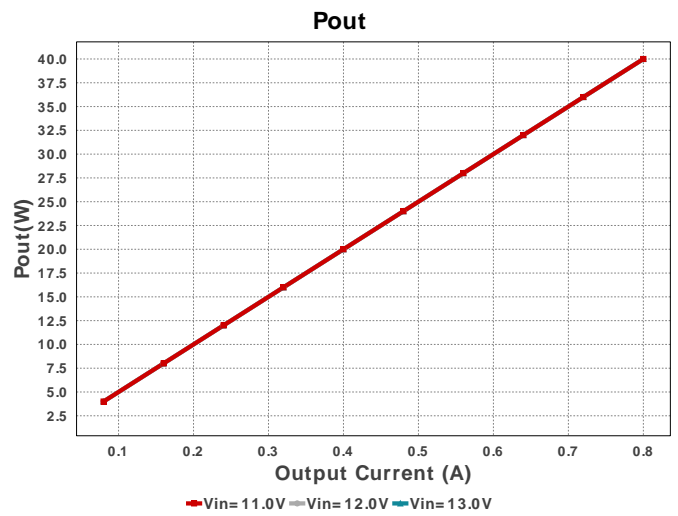
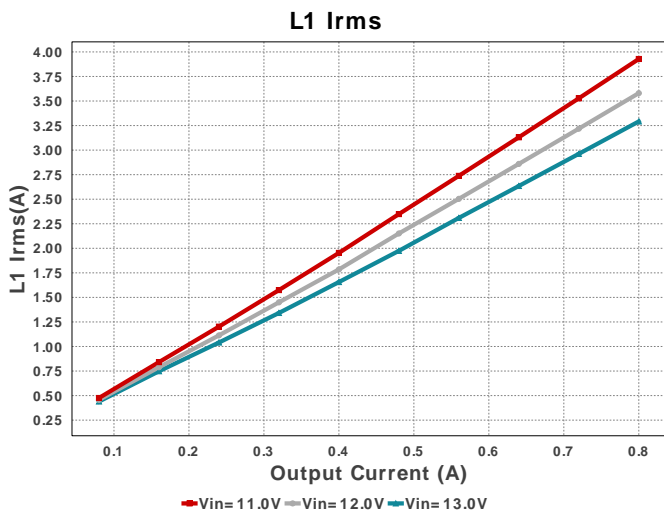
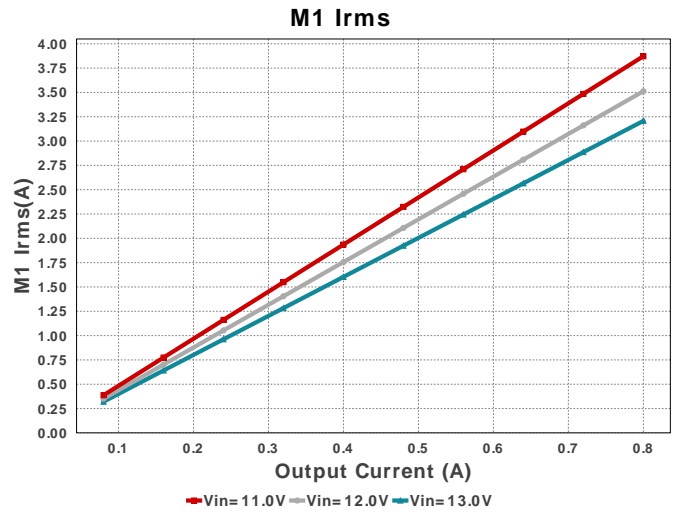
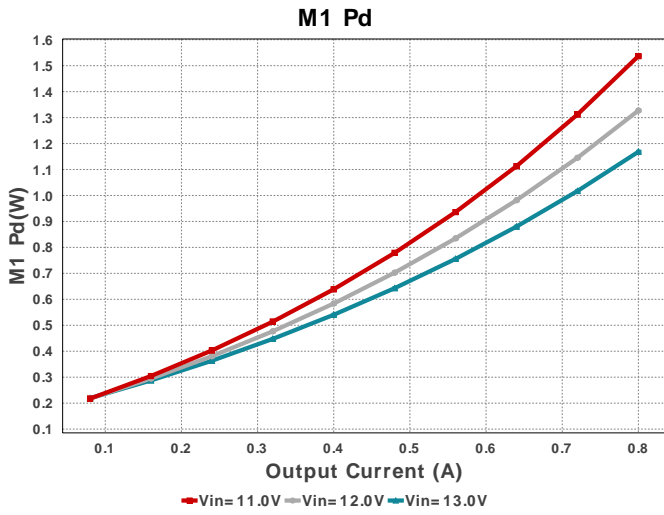

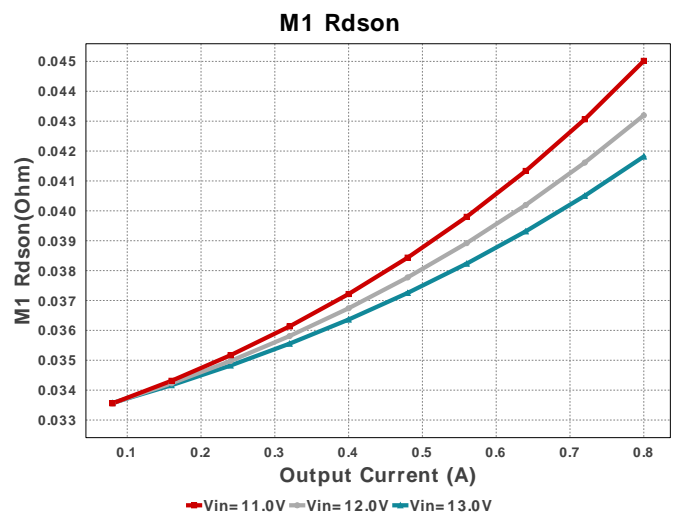
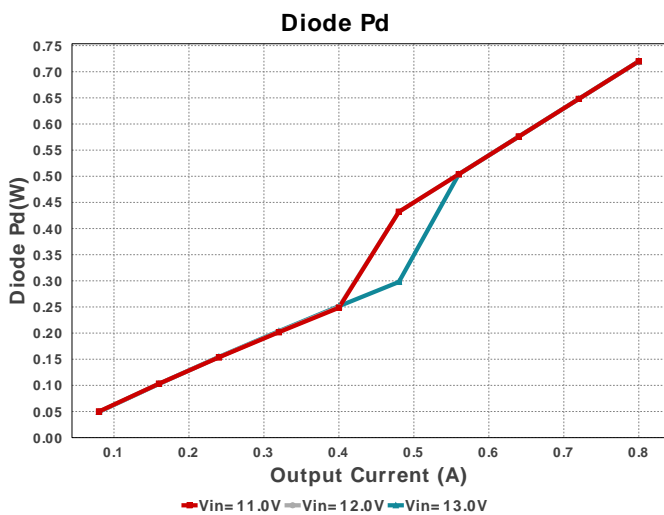
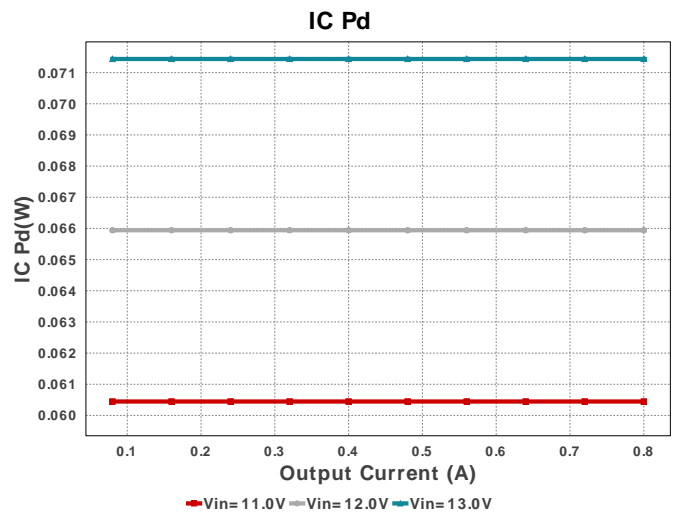
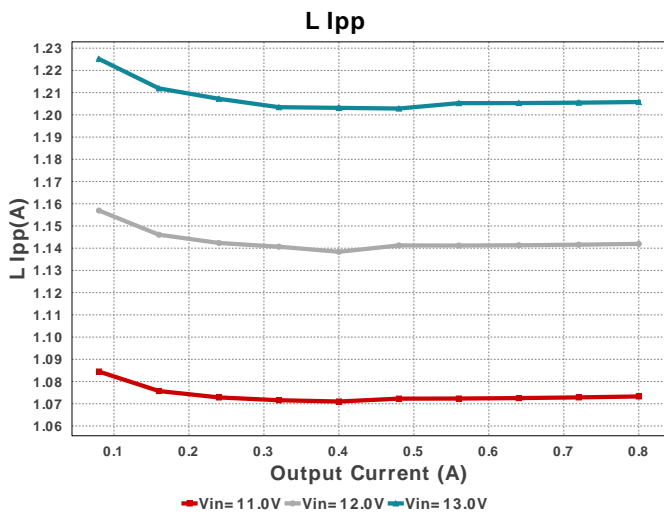
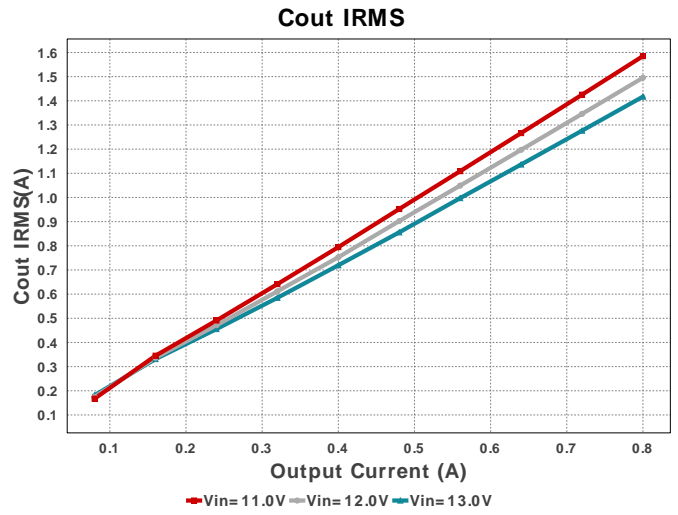
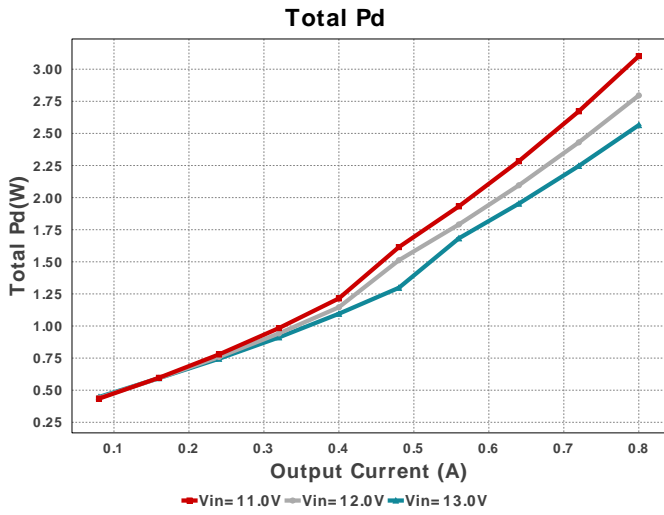

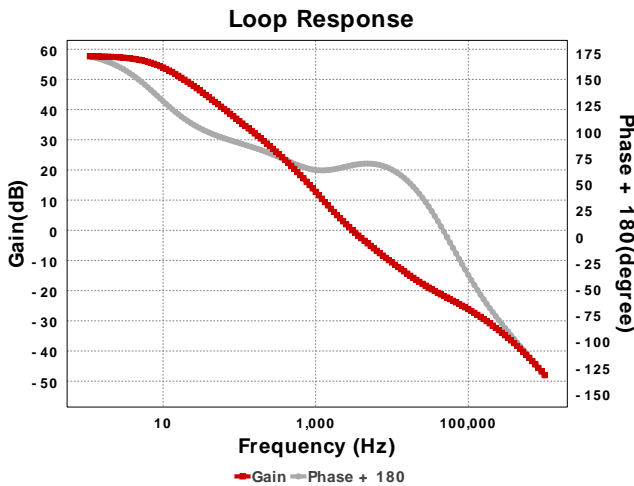
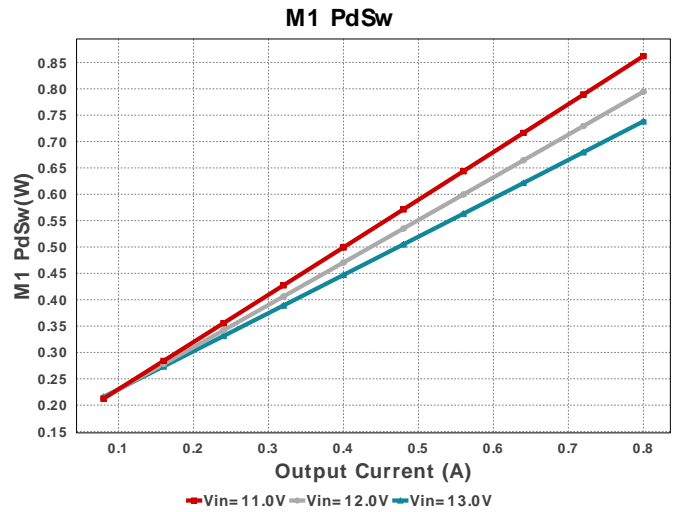
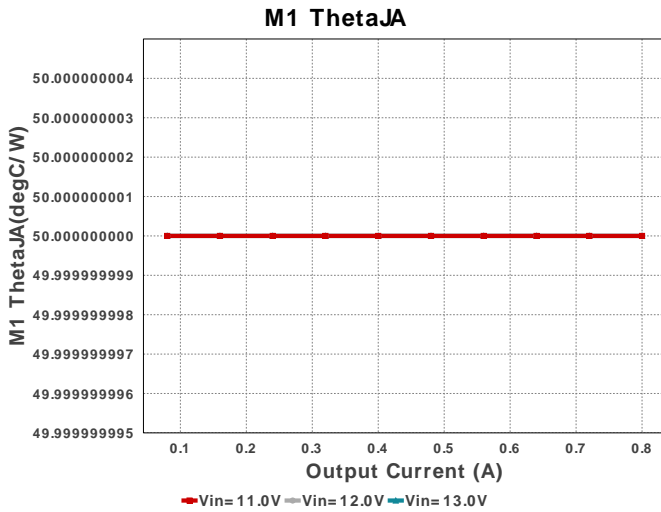

Operating Values

#	Name	Value	Category	Description
1.	Cin IRMS	306.928 mA	Capacitor	Input capacitor RMS ripple current
2.	Cin Pd	32.972 mW	Capacitor	Input capacitor power dissipation
3.	Cout IRMS	1.549 A	Capacitor	Output capacitor RMS ripple current
4.	Cout Pd	204.07 mW	Capacitor	Output capacitor power dissipation
5.	D1 Tj	93.36 degC	Diode	D1 junction temperature
6.	Diode Pd	720.0 mW	Diode	Diode power dissipation
7.	IC Pd	60.698 mW	IC	IC power dissipation
8.	IC Tj	42.14 degC	IC	IC junction temperature
9.	IC Tolerance	24.3 mV	IC	IC Feedback Tolerance
10.	ICThetaJA	200.0 degC/W	IC	IC junction-to-ambient thermal resistance
11.	Iin Avg	3.775 A	IC	Average input current
12.	L Ipp	1.063 A	Inductor	Peak-to-peak inductor ripple current
13.	L Pd	327.25 mW	Inductor	Inductor power dissipation
14.	L1 Irms	3.789 A	Inductor	Inductor ripple current
15.	M Vds Act	174.809 mV	Mosfet	M Vds
16.	M1 Irms	3.872 A	Mosfet	M1 MOSFET Irms
17.	M1 Pd	1.552 W	Mosfet	M1 MOSFET total power dissipation
18.	M1 PdCond	676.83 mW	Mosfet	M1 MOSFET conduction losses
19.	M1 PdSw	875.21 mW	Mosfet	M1 MOSFET switching losses
20.	M1 Rdson	45.149 mOhm	Mosfet	Drain-Source On-resistance
21.	M1 ThetaJA	50.0 degC/W	Mosfet	MOSFET junction-to-ambient thermal resistance
22.	M1 TjOP	107.6 degC	Mosfet	M1 MOSFET junction temperature
23.	Cin Pd	32.972 mW	Power	Input capacitor power dissipation
24.	Cout Pd	204.07 mW	Power	Output capacitor power dissipation
25.	Diode Pd	720.0 mW	Power	Diode power dissipation
26.	IC Pd	60.698 mW	Power	IC power dissipation
27.	L Pd	327.25 mW	Power	Inductor power dissipation
28.	M1 Pd	1.552 W	Power	M1 MOSFET total power dissipation
29.	M1 PdCond	676.83 mW	Power	M1 MOSFET conduction losses
30.	M1 PdSw	875.21 mW	Power	M1 MOSFET switching losses
31.	Rfb Pd	63.652 mW	Power	Rfb Power Dissipation
32.	Rsense Pd	137.03 mW	Power	LED Current Rsns Power Dissipation

#	Name	Value	Category	Description
33.	Total Pd	1.521 W	Power	Total Power Dissipation
34.	Rfb Pd	63.652 mW	Resistor	Rfb Power Dissipation
35.	Rsense Pd	137.03 mW	Resistor	LED Current Rsns Power Dissipation
36.	BOM Count	18	System Information	Total Design BOM count
37.	Cross Freq	2.7 kHz	System Information	Bode plot crossover frequency
38.	Duty Cycle	78.814 %	System Information	Duty cycle
39.	Efficiency	96.337 %	System Information	Steady state efficiency
40.	FootPrint	1.288 k mm ²	System Information	Total Foot Print Area of BOM components
41.	Frequency	541.734 kHz	System Information	Switching frequency
42.	Gain Marg	-21.194 dB	System Information	Bode Plot Gain Margin
43.	Iout	800.0 mA	System Information	Iout operating point
44.	Low Freq Gain	56.415 dB	System Information	Gain at 1Hz
45.	Mode	CCM	System Information	Conduction Mode
46.	Phase Marg	66.786 deg	System Information	Bode Plot Phase Margin
47.	Pout	40.0 W	System Information	Total output power
48.	SW Ipk	4.308 A	System Information	Peak switch current
49.	Total BOM	\$3.71	System Information	Total BOM Cost
50.	Vin	11.0 V	System Information	Vin operating point
51.	Vout	50.0 V	System Information	Operational Output Voltage
52.	Vout Actual	50.705 V	System Information	Vout Actual calculated based on selected voltage divider resistors
53.	Vout Tolerance	3.937 %	System Information	Vout Tolerance based on IC Tolerance (no load) and voltage divider resistors if applicable
54.	Vout p-p	366.157 mV	System Information	Peak-to-peak output ripple voltage

Design Inputs

Name	Value	Description
Iout	800.0 m	Maximum Output Current
VinMax	13.0	Maximum input voltage
VinMin	11.0	Minimum input voltage
Vout	50.0	Output Voltage
base_pn	LM3478	Base Product Number
source	DC	Input Source Type
Ta	30.0	Ambient temperature

WEBENCH® Assembly

Component Testing

Some published data on components in datasheets such as Capacitor ESR and Inductor DC resistance is based on conservative values that will guarantee that the components always exceed the specification. For design purposes it is usually better to work with typical values. Since this data is not always available it is a good practice to measure the Capacitance and ESR values of C_{in} and C_{out} , and the inductance and DC resistance of L1 before assembly of the board. Any large discrepancies in values should be electrically simulated in WEBENCH to check for instabilities and thermally simulated in WebTHERM to make sure critical temperatures are not exceeded.

Soldering Component to Board

If board assembly is done in house it is best to tack down one terminal of a component on the board then solder the other terminal. For surface mount parts with large tabs, such as the DPAK, the tab on the back of the package should be pre-tinned with solder, then tacked into place by one of the pins. To solder the tab down to the board place the iron down on the board while resting against the tab, heating both surfaces simultaneously. Apply light pressure to the top of the plastic case until the solder flows around the part and the part is flush with the PCB. If the solder is not flowing around the board you may need a higher wattage iron (generally 25W to 30W is enough).

Initial Startup of Circuit

It is best to initially power up the board by setting the input supply voltage to the lowest operating input voltage 11.0V and set the input supply's current limit to zero. With the input supply off connect up the input supply to V_{in} and GND. Connect a digital volt meter and a load if needed to set the minimum load of the design from V_{out} and GND. Turn on the input supply and slowly turn up the current limit on the input supply. If the voltage starts to rise on the input supply continue increasing the input supply current limit while watching the output voltage. If the current increases on the input supply, but the voltage remains near zero, then there may be a short or a component misplaced on the board. Power down the board and visually inspect for solder bridges and recheck the diode and capacitor polarities. Once the power supply circuit is operational then more extensive testing may include full load testing, transient load and line tests to compare with simulation results.

Load Testing

The setup is the same as the initial startup, except that an additional digital voltmeter is connected between V_{in} and GND, a load is connected between V_{out} and GND and a current meter is connected in series between V_{out} and the load. The load must be able to handle at least rated output power + 50% (7.5 watts for this design). Ideally the load is supplied in the form of a variable load test unit. It can also be done in the form of suitably large power resistors. When using an oscilloscope to measure waveforms on the prototype board, the ground leads of the oscilloscope probes should be as short as possible and the area of the loop formed by the ground lead should be kept to a minimum. This will help reduce ground lead inductance and eliminate EMI noise that is not actually present in the circuit.

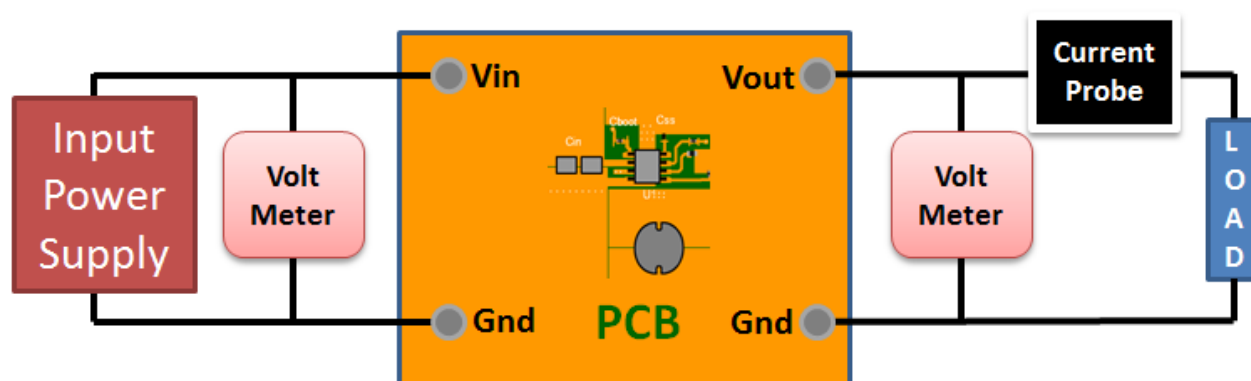

Design Assistance

1. Master key : 986E7DB8F53ED6DD[v1]
2. **LM3478** Product Folder : <http://www.ti.com/product/LM3478> : contains the data sheet and other resources.

Important Notice and Disclaimer

TI provides technical and reliability data (including datasheets), design resources (including reference designs), application or other design advice, web tools, safety information, and other resources AS IS and with all faults, and disclaims all warranties. These resources are intended for skilled developers designing with TI products. You are solely responsible for (1) selecting the appropriate TI products for your application, (2) designing, validating and testing your application, and (3) ensuring your application meets applicable standards, and any other safety, security, or other requirements.

These resources are subject to change without notice. TI grants you permission to use these resources only for development of an application that uses the TI products described in the resource. Other reproduction and display of these resources is prohibited. No license is granted to any other TI intellectual property right or to any third party intellectual property right. TI disclaims responsibility for, and you will fully indemnify TI and its representatives against, any claims, damages, costs, losses, and liabilities arising out of your use of these resources.

Providing these resources does not expand or otherwise alter TI's applicable Terms of Sale or other applicable terms available either on ti.com or provided in conjunction with TI products.