

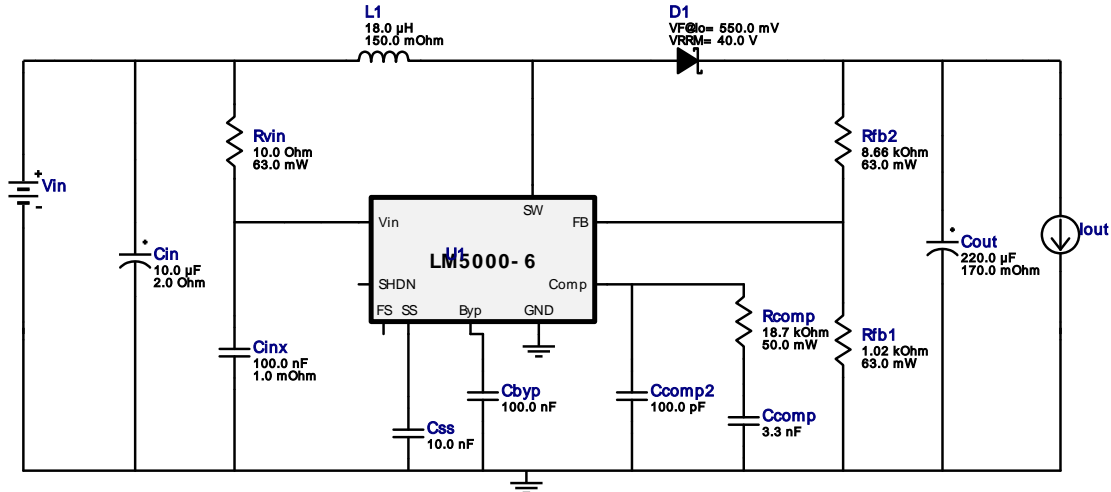

**WEBENCH® Design Report**

 Design : 11930 LM5000SDX-3/NOPB  
 LM5000SDX-3/NOPB 5V-8V to 12.00V @ 0.3A

**Electrical BOM**

Name	Manufacturer	Part Number	Properties	Qty	Price	Footprint
Cbyp	AVX	08053C104JAZ2A Series= X7R	Cap= 100.0 nF VDC= 25.0 V IRMS= 0.0 A	1	\$0.06	 0805 7 mm <sup>2</sup>
Ccomp	TDK	C2012C0G1H332J060AA Series= C0G/NP0	Cap= 3.3 nF VDC= 50.0 V IRMS= 0.0 A	1	\$0.03	 0805 7 mm <sup>2</sup>
Ccomp2	Kemet	C0201C101K3GACTU Series= C0G/NP0	Cap= 100.0 pF VDC= 10.0 V IRMS= 0.0 A	1	\$0.01	 0201 2 mm <sup>2</sup>
Cin	Vishay-Sprague	293D106X0016B2TE3 Series= 293D	Cap= 10.0 uF ESR= 2.0 Ohm VDC= 16.0 V IRMS= 210.0 mA	1	\$0.10	 3528-21 17 mm <sup>2</sup>
Cinx	MuRata	GRM155R71A104KA01D Series= X7R	Cap= 100.0 nF ESR= 1.0 mOhm VDC= 10.0 V IRMS= 0.0 A	1	\$0.01	 0402 3 mm <sup>2</sup>
Cout	Nichicon	UUD1E221MNL1GS Series= uD	Cap= 220.0 uF ESR= 170.0 mOhm VDC= 25.0 V IRMS= 450.0 mA	1	\$0.17	 SM_RADIAL_8MM 113 mm <sup>2</sup>
Css	TDK	CGA4C2C0G1H103J060AA Series= C0G/NP0	Cap= 10.0 nF VDC= 50.0 V IRMS= 0.0 A	1	\$0.06	 0805 7 mm <sup>2</sup>
D1	Fairchild Semiconductor	SS14FL	VF@Io= 550.0 mV VRRM= 40.0 V	1	\$0.04	 SOD-123F 12 mm <sup>2</sup>
L1	NIC Components	NPI54C180MTRF	L= 18.0 uH 150.0 mOhm	1	\$0.12	 IND_NPI54C 61 mm <sup>2</sup>
Rcomp	Yageo	RC0201FR-0718K7L Series= ?	Res= 18.7 kOhm Power= 50.0 mW Tolerance= 1.0%	1	\$0.01	 0201 2 mm <sup>2</sup>

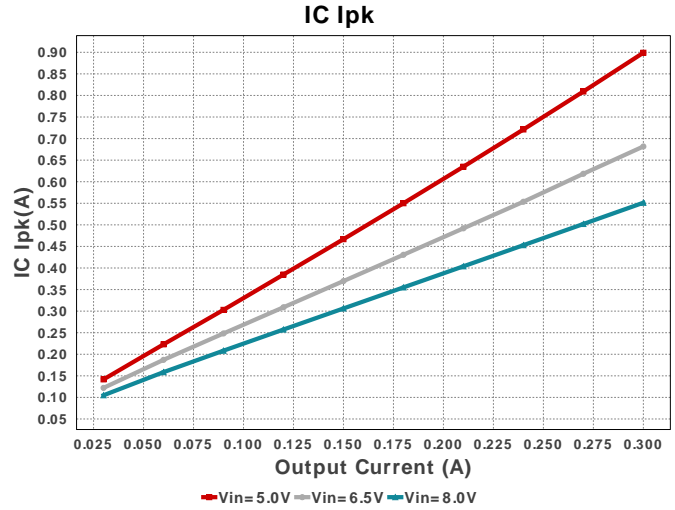
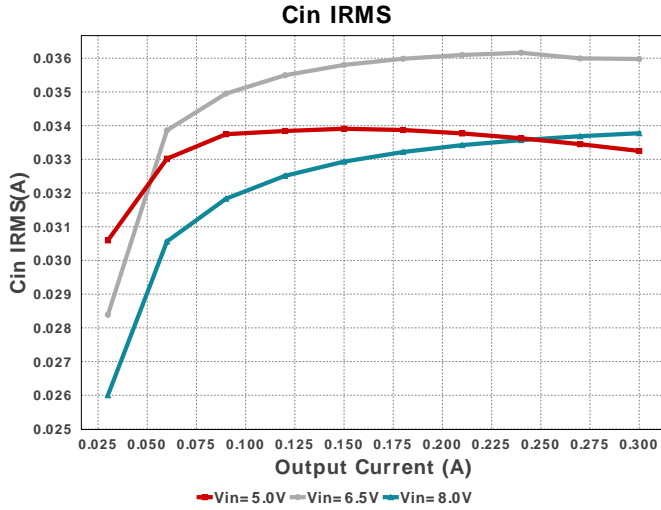
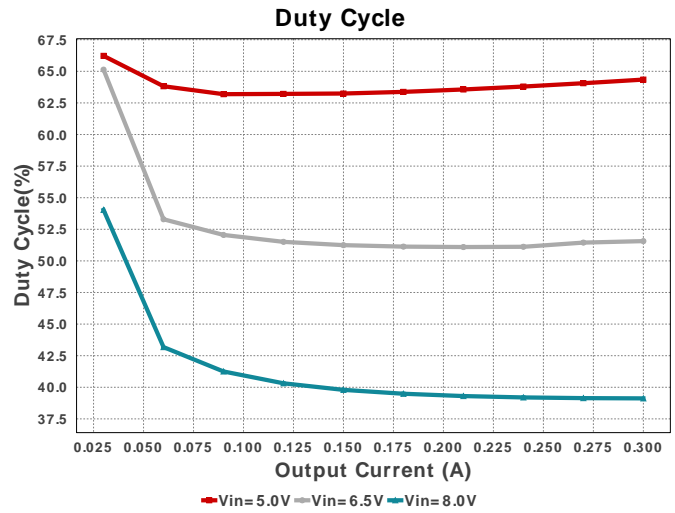
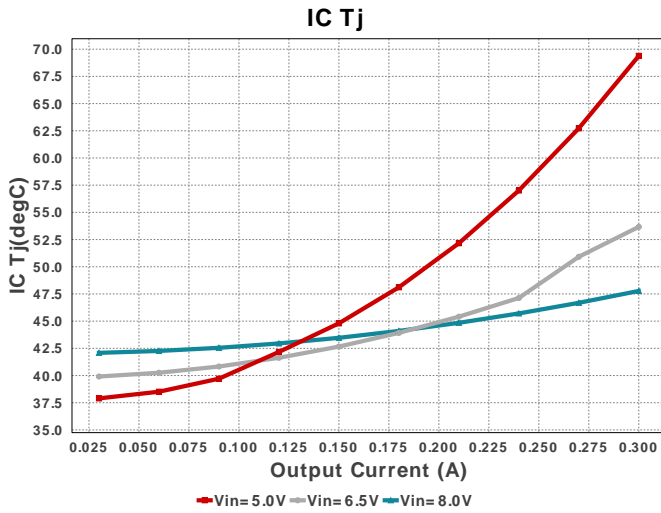
Name	Manufacturer	Part Number	Properties	Qty	Price	Footprint
Rfb1	Vishay-Dale	CRCW04021K02FKED Series= CRCW..e3	Res= 1.02 kOhm Power= 63.0 mW Tolerance= 1.0%	1	\$0.01	0402 3 mm <sup>2</sup>
Rfb2	Vishay-Dale	CRCW04028K66FKED Series= CRCW..e3	Res= 8.66 kOhm Power= 63.0 mW Tolerance= 1.0%	1	\$0.01	0402 3 mm <sup>2</sup>
Rvin	Vishay-Dale	CRCW040210R0FKED Series= CRCW..e3	Res= 10.0 Ohm Power= 63.0 mW Tolerance= 1.0%	1	\$0.01	0402 3 mm <sup>2</sup>
U1	Texas Instruments	LM5000SDX-3/NOPB	Switcher	1	\$1.74	 SDA16A 58 mm <sup>2</sup>

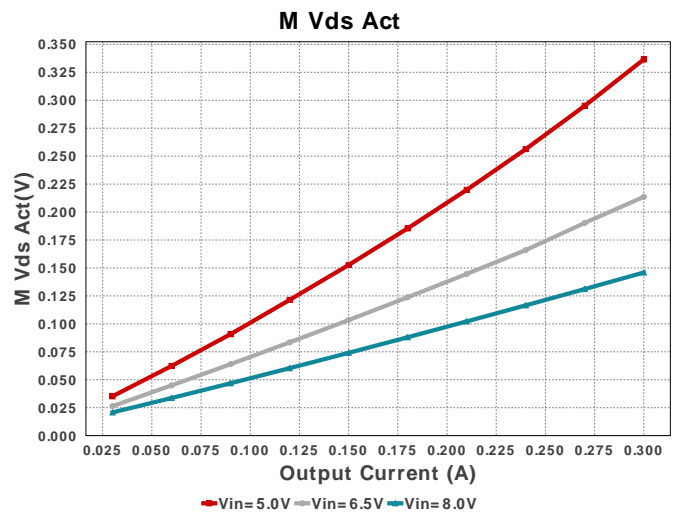
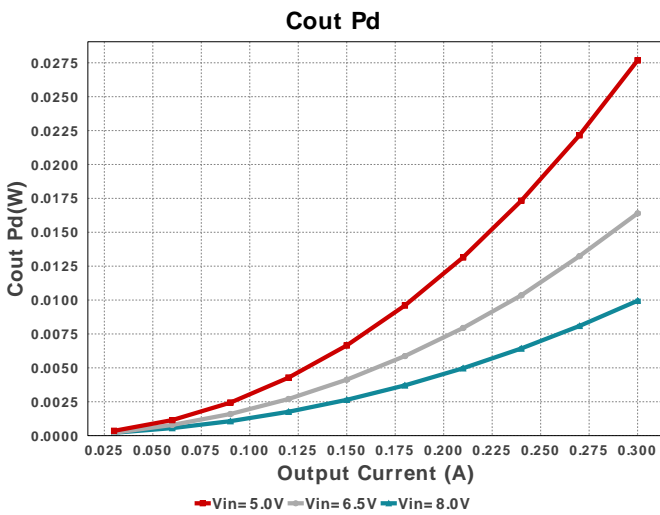
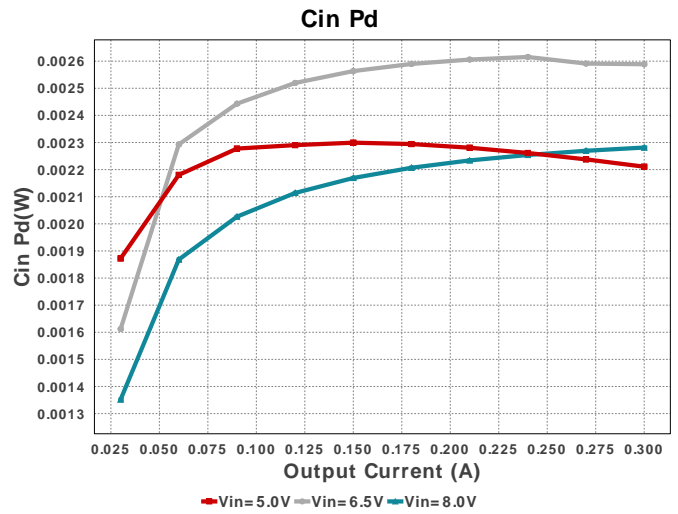
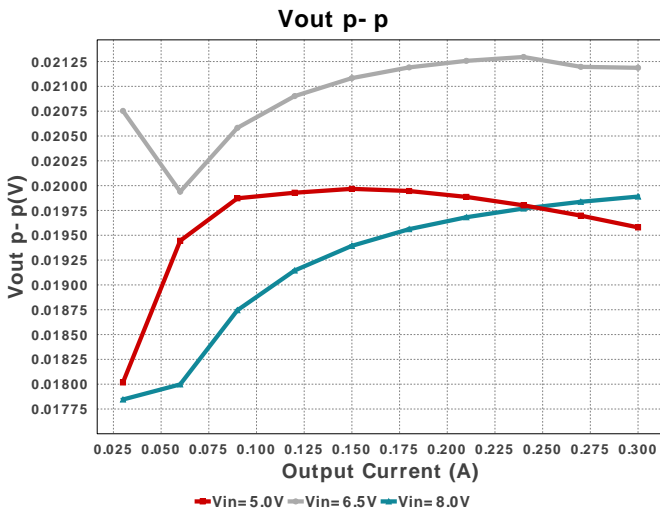
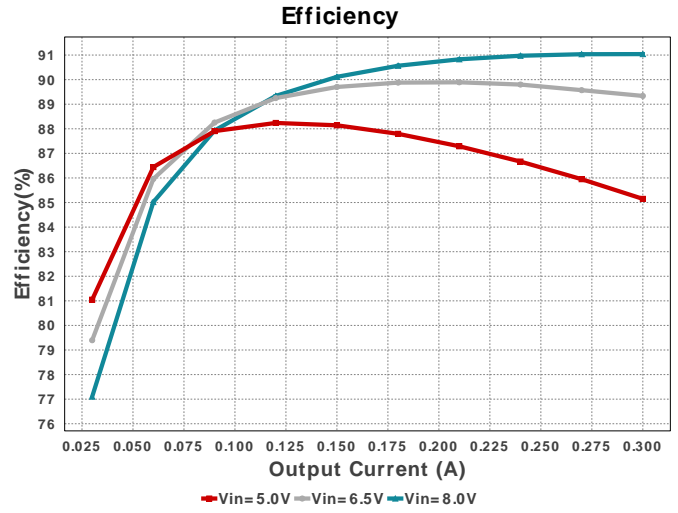
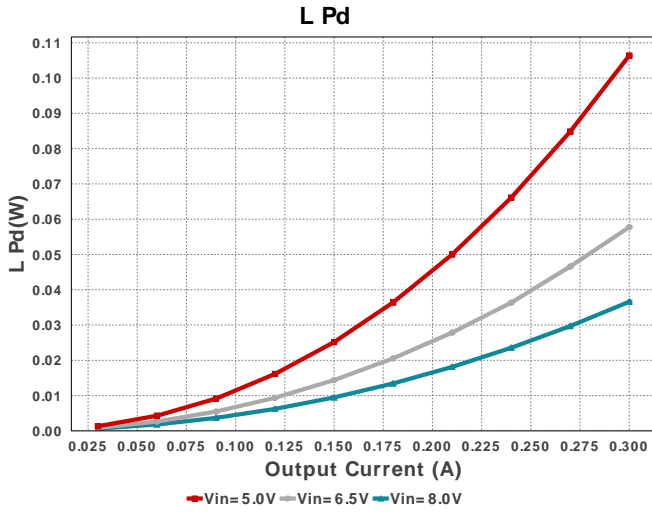

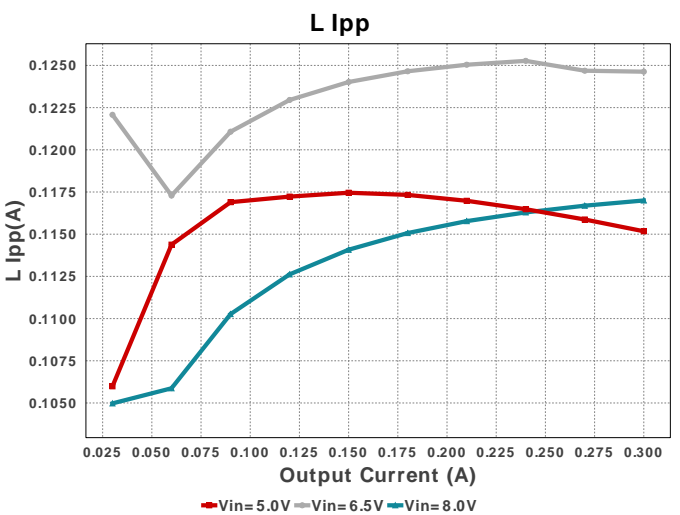
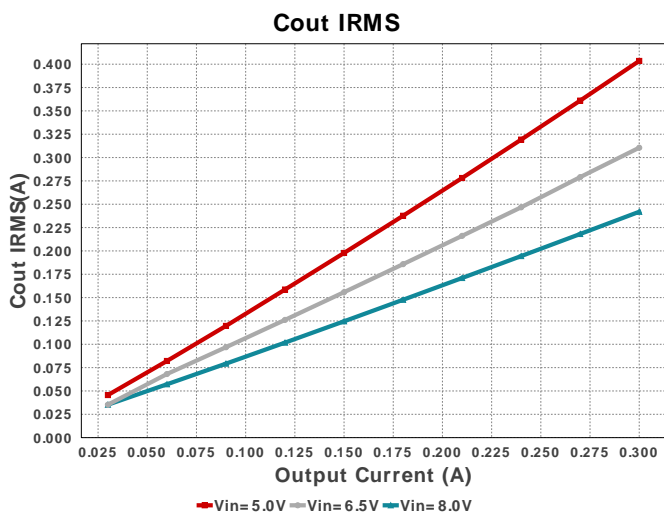
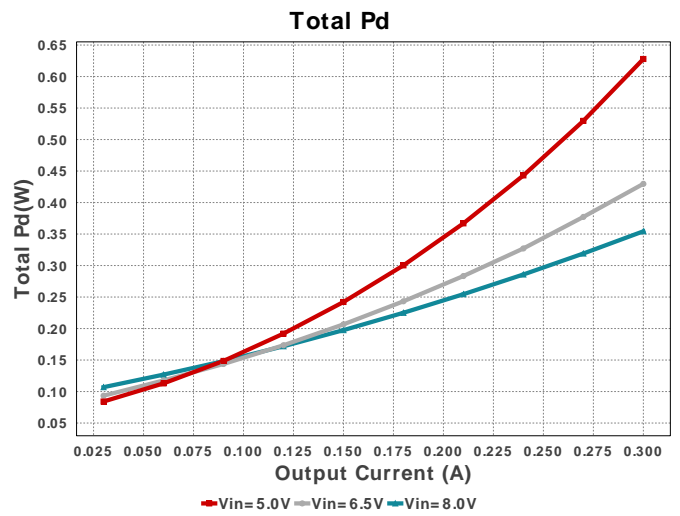
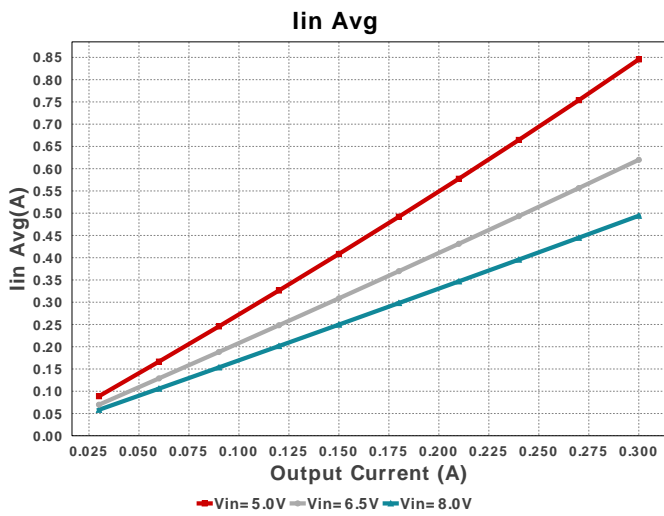
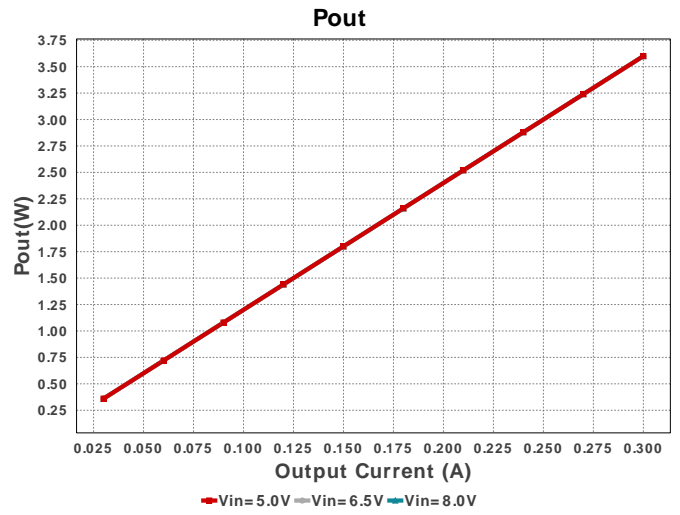
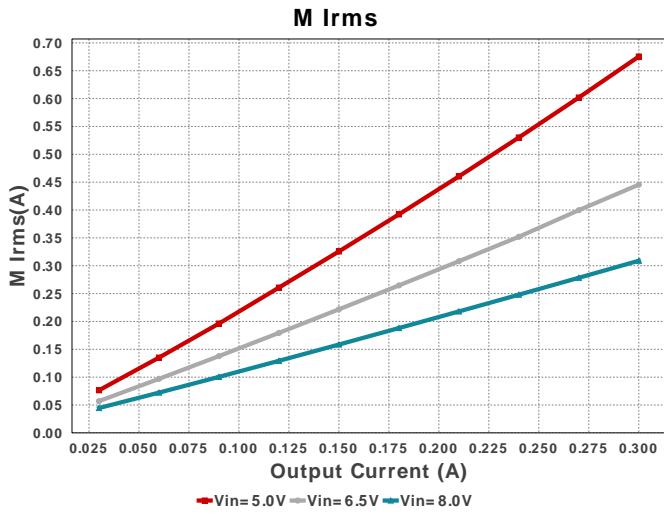



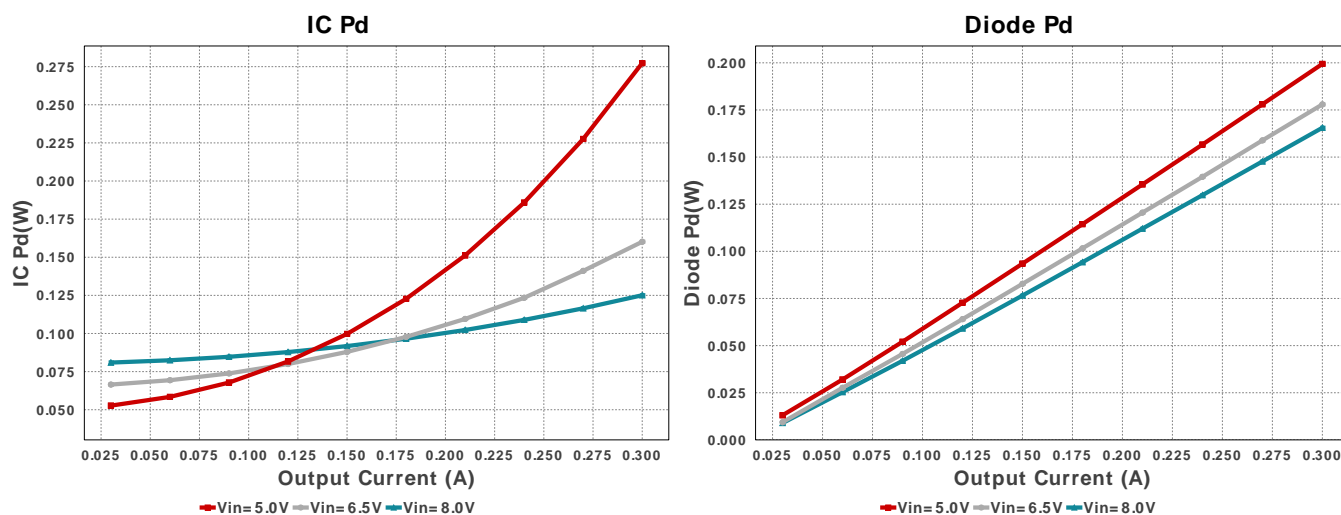

## Operating Values

#	Name	Value	Category	Description
1.	Cin IRMS	33.248 mA	Capacitor	Input capacitor RMS ripple current
2.	Cin Pd	2.211 mW	Capacitor	Input capacitor power dissipation
3.	Cout IRMS	403.503 mA	Capacitor	Output capacitor RMS ripple current
4.	Cout Pd	27.679 mW	Capacitor	Output capacitor power dissipation
5.	Diode Pd	199.41 mW	Diode	Diode power dissipation
6.	IC Ipk	898.989 mA	IC	Peak switch current in IC
7.	IC Pd	277.33 mW	IC	IC power dissipation
8.	IC Tj	69.387 degC	IC	IC junction temperature
9.	IC Tolerance	26.0 mV	IC	IC Feedback Tolerance
10.	ICThetaJA	150.0 degC/W	IC	IC junction-to-ambient thermal resistance
11.	Iin Avg	845.57 mA	IC	Average input current
12.	L Ipp	115.17 mA	Inductor	Peak-to-peak inductor ripple current
13.	L Pd	106.36 mW	Inductor	Inductor power dissipation
14.	M Rrms	675.461 mA	Mosfet	MOSFET RMS ripple current
15.	M Vds Act	336.558 mV	Mosfet	
16.	Cin Pd	2.211 mW	Power	Input capacitor power dissipation
17.	Cout Pd	27.679 mW	Power	Output capacitor power dissipation
18.	Diode Pd	199.41 mW	Power	Diode power dissipation
19.	IC Pd	277.33 mW	Power	IC power dissipation
20.	L Pd	106.36 mW	Power	Inductor power dissipation
21.	Total Pd	627.878 mW	Power	Total Power Dissipation
22.	BOM Count	14	System	Total Design BOM count
23.	Cross Freq	780.006 Hz	System Information	Bode plot crossover frequency
24.	Duty Cycle	64.345 %	System Information	Duty cycle
25.	Efficiency	85.149 %	System Information	Steady state efficiency
26.	FootPrint	297.0 mm <sup>2</sup>	System Information	Total Foot Print Area of BOM components
27.	Frequency	1.3 MHz	System Information	Switching frequency
28.	Iout	300.0 mA	System Information	Iout operating point
29.	Mode	CCM	System Information	Conduction Mode
30.	Phase Marg	31.681 deg	System Information	Bode Plot Phase Margin
31.	Pout	3.6 W	System Information	Total output power
32.	Total BOM	\$2.38	System Information	Total BOM Cost
33.	Vin	5.0 V	System Information	Vin operating point
34.	Vout Actual	11.948 V	System Information	Vout Actual calculated based on selected voltage divider resistors
35.	Vout Tolerance	3.91 %	System Information	Vout Tolerance based on IC Tolerance (no load) and voltage divider resistors if applicable
36.	Vout p-p	19.58 mV	System Information	Peak-to-peak output ripple voltage

## Design Inputs

Name	Value	Description
Iout	300.0 m	Maximum Output Current
VinMax	8.0	Maximum input voltage
VinMin	5.0	Minimum input voltage
Vout	12.0	Output Voltage
base_pn	LM5000-6	Base Product Number
source	DC	Input Source Type
Ta	30.0	Ambient temperature

## WEBENCH® Assembly

### Component Testing

Some published data on components in datasheets such as Capacitor ESR and Inductor DC resistance is based on conservative values that will guarantee that the components always exceed the specification. For design purposes it is usually better to work with typical values. Since this data is not always available it is a good practice to measure the Capacitance and ESR values of  $C_{in}$  and  $C_{out}$ , and the inductance and DC resistance of L1 before assembly of the board. Any large discrepancies in values should be electrically simulated in WEBENCH to check for instabilities and thermally simulated in WebTHERM to make sure critical temperatures are not exceeded.

### Soldering Component to Board

If board assembly is done in house it is best to tack down one terminal of a component on the board then solder the other terminal. For surface mount parts with large tabs, such as the DPAK, the tab on the back of the package should be pre-tinned with solder, then tacked into place by one of the pins. To solder the tab down to the board place the iron down on the board while resting against the tab, heating both surfaces simultaneously. Apply light pressure to the top of the plastic case until the solder flows around the part and the part is flush with the PCB. If the solder is not flowing around the board you may need a higher wattage iron (generally 25W to 30W is enough).

### Initial Startup of Circuit

It is best to initially power up the board by setting the input supply voltage to the lowest operating input voltage 5.0V and set the input supply's current limit to zero. With the input supply off connect up the input supply to  $V_{in}$  and GND. Connect a digital volt meter and a load if needed to set the minimum load of the design from  $V_{out}$  and GND. Turn on the input supply and slowly turn up the current limit on the input supply. If the voltage starts to rise on the input supply continue increasing the input supply current limit while watching the output voltage. If the current increases on the input supply, but the voltage remains near zero, then there may be a short or a component misplaced on the board. Power down the board and visually inspect for solder bridges and recheck the diode and capacitor polarities. Once the power supply circuit is operational then more extensive testing may include full load testing, transient load and line tests to compare with simulation results.

### Load Testing

The setup is the same as the initial startup, except that an additional digital voltmeter is connected between  $V_{in}$  and GND, a load is connected between  $V_{out}$  and GND and a current meter is connected in series between  $V_{out}$  and the load. The load must be able to handle at least rated output power + 50% ( 7.5 watts for this design). Ideally the load is supplied in the form of a variable load test unit. It can also be done in the form of suitably large power resistors. When using an oscilloscope to measure waveforms on the prototype board, the ground leads of the oscilloscope probes should be as short as possible and the area of the loop formed by the ground lead should be kept to a minimum. This will help reduce ground lead inductance and eliminate EMI noise that is not actually present in the circuit.



### Design Assistance

1. Master key : 1B0CCE6EBD53FA1F[v1]
2. **LM5000-6** Product Folder : <http://www.ti.com/product/LM5000> : contains the data sheet and other resources.

#### Important Notice and Disclaimer

TI provides technical and reliability data (including datasheets), design resources (including reference designs), application or other design advice, web tools, safety information, and other resources AS IS and with all faults, and disclaims all warranties. These resources are intended for skilled developers designing with TI products. You are solely responsible for (1) selecting the appropriate TI products for your application, (2) designing, validating and testing your application, and (3) ensuring your application meets applicable standards, and any other safety, security, or other requirements.

These resources are subject to change without notice. TI grants you permission to use these resources only for development of an application that uses the TI products described in the resource. Other reproduction and display of these resources is prohibited. No license is granted to any other TI intellectual property right or to any third party intellectual property right. TI disclaims responsibility for, and you will fully indemnify TI and its representatives against, any claims, damages, costs, losses, and liabilities arising out of your use of these resources.

Providing these resources does not expand or otherwise alter TI's applicable Terms of Sale or other applicable terms available either on ti.com or provided in conjunction with TI products.