

- The boost stage design is based on UCC28513. The PFC stage works well up to 200-220Vac input. Above this voltage range there are significant distortions at the points where sinusoidal input voltage reaches to its positive and negative peaks
- Output voltage is 385Vac
- Input voltage range is 85-264Vac; 50/60Hz
- The load on DC link output is 120W max
- Boost stage switching frequency is 277kHz
- Verified that the Vcc aux supply and Vref are stable
- Observed that the AC ripple on DC link goes up at around 200Vac but not sure if this is the reason or the result
- Observed that the duty cycle is about 70% at the peak sine wave at 85Vac but drops down to ~15% at the peaks of 220Vac at which point I start get distortions on the input current.
- The provided test results are at ~30W output power. It was observed that changing the load did not affect the behavior at around 220Vac.

Questions:

1. Based on the design values, what could potentially cause the distortions at the peak of sine waves at and above ~ 200Vac?
2. Fig. 36 on data sheet talks about max capacitance vs min duty cycle. What capacitor is referred in Fig 36?

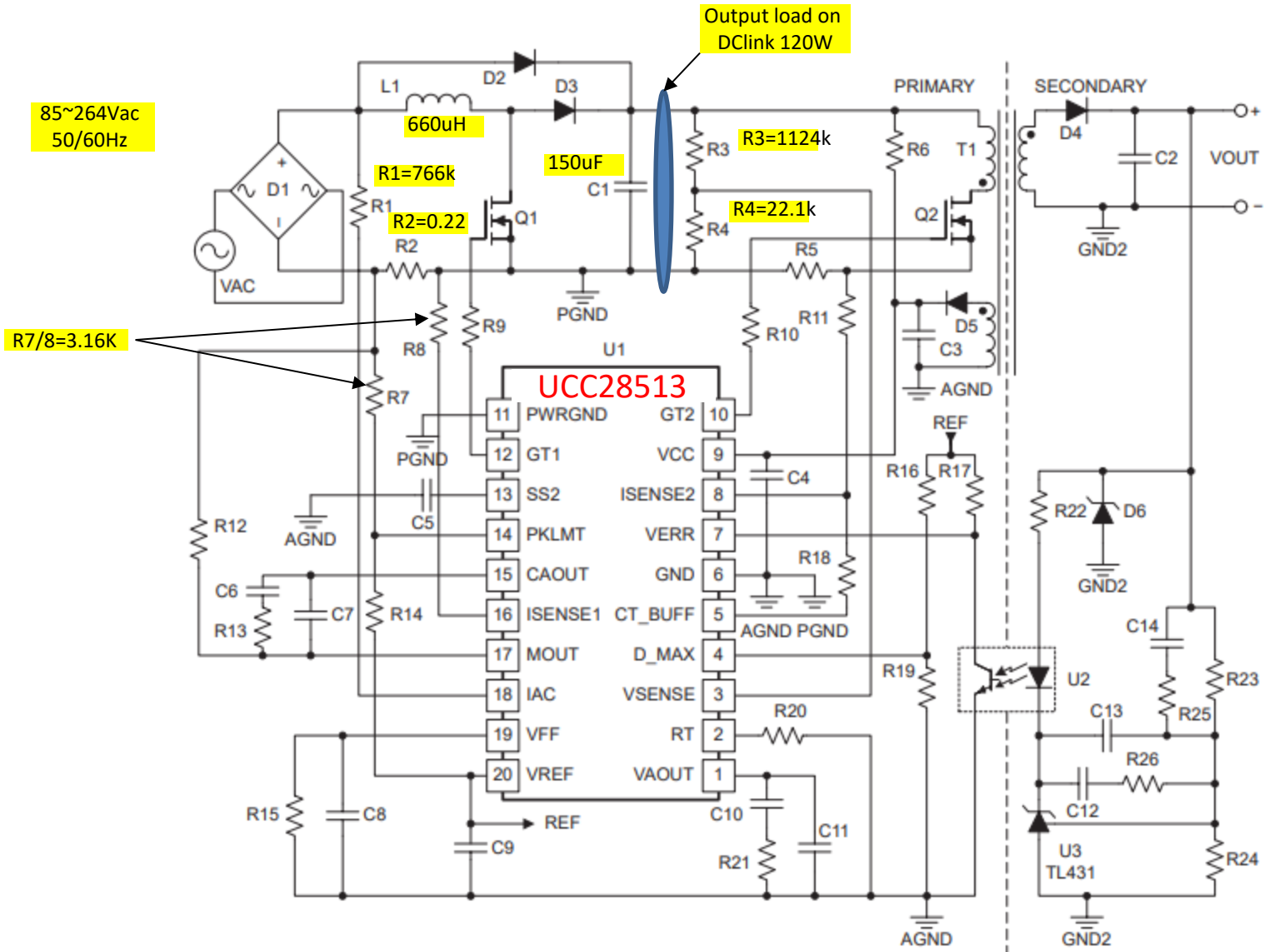

RefDes on data sheet	RefDes in design	values
R1	R47+R50	766K
R2	R43	0.22
R8/R12	R4/R9	3.16K
R3	R44+R49	1124K
R4	R60	22.1k
C1	C32	150uF
L1	L2	660uH
R13	R10	15.8K
C6	C6	680pF
C7	C8	150pF
R15	R11	30.1K
C8	C9	4.7uF
C10	C1	1.5uF
C11	C2	150nF
R21	R1	48.7K
R14	R13	10K
R7	R5	1.18K
C9	C4	1uF

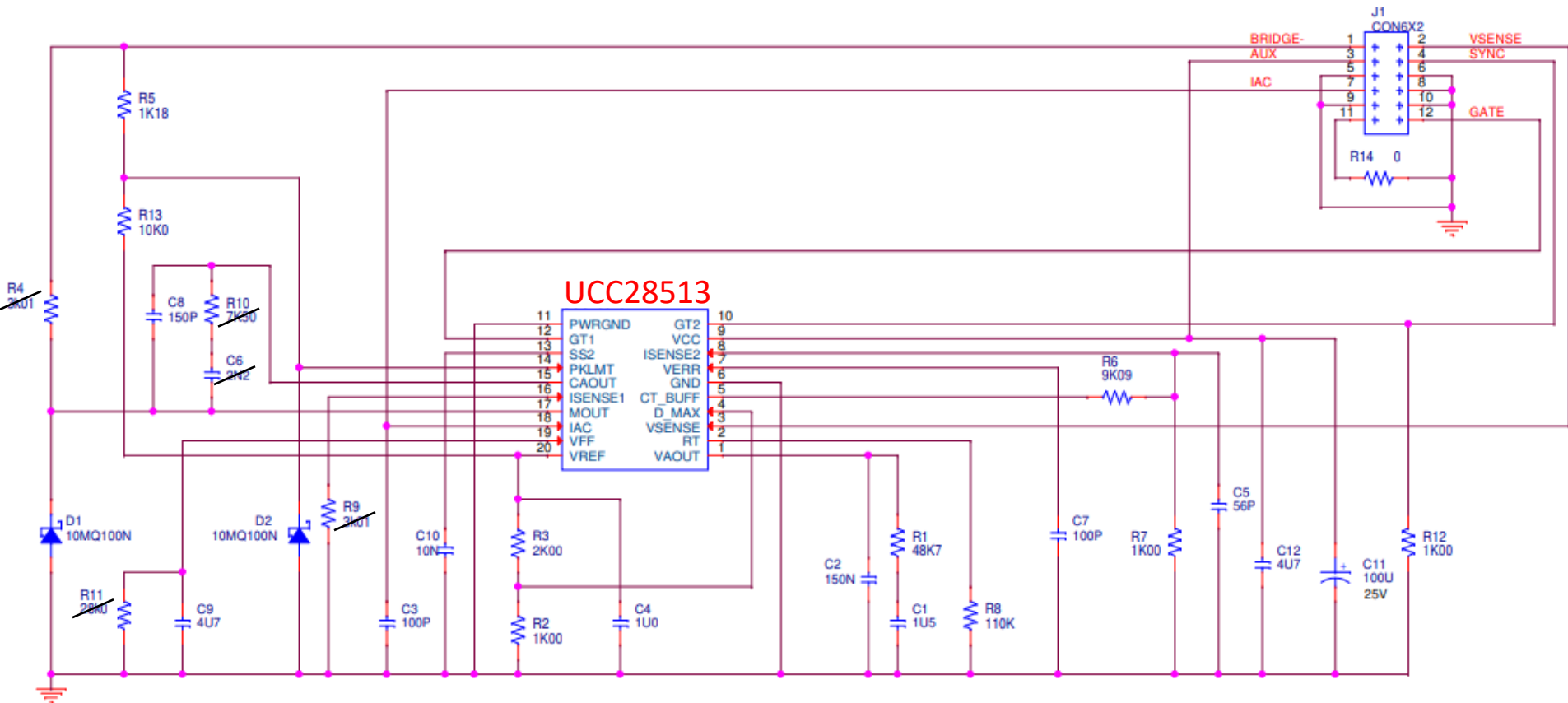

RefDes on data sheet	RefDes in design	values
R8/R12	R4/R9	3.16K
R13	R10	15.8K
C6	C6	680pF
R15	R11	30.1K

RIGOL

STOP

H 5.00ms

50.0MS/s
3.00M pts

D

1.70000000ms

T

f -4.00V

Horizontal

No distortions at 85Vac

- Period
- Freq
- Rise Time
- Fall Time
- +Width
- Width

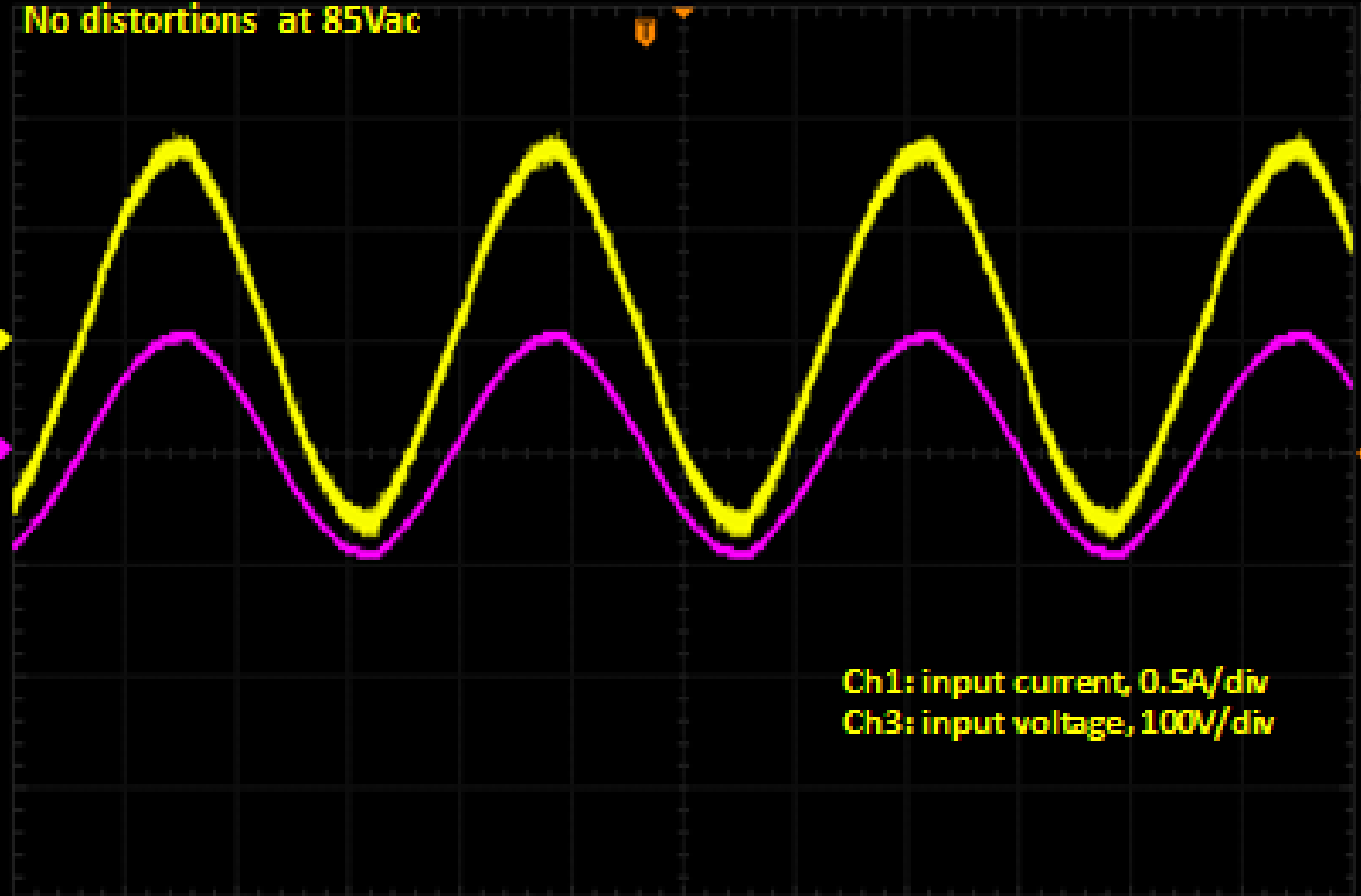

- Coupling: DC
- BW Limit: 20M
- Probe: 100X
- Invert: ON
- Volts/Div: Coarse
- Unit: [V]

1 = 500mA 2 = 2.00V 3 = 100V 4 = 2.00V

RIGOL

TD

H 5.00ms

50.0MSa/s
3.00M pts



D 1.70000000ms

T f [] -4.00 V

Horizontal

No distortions at 120Vac

- Period
- Freq
- Rise Time
- Fall Time
- +Width
- Width

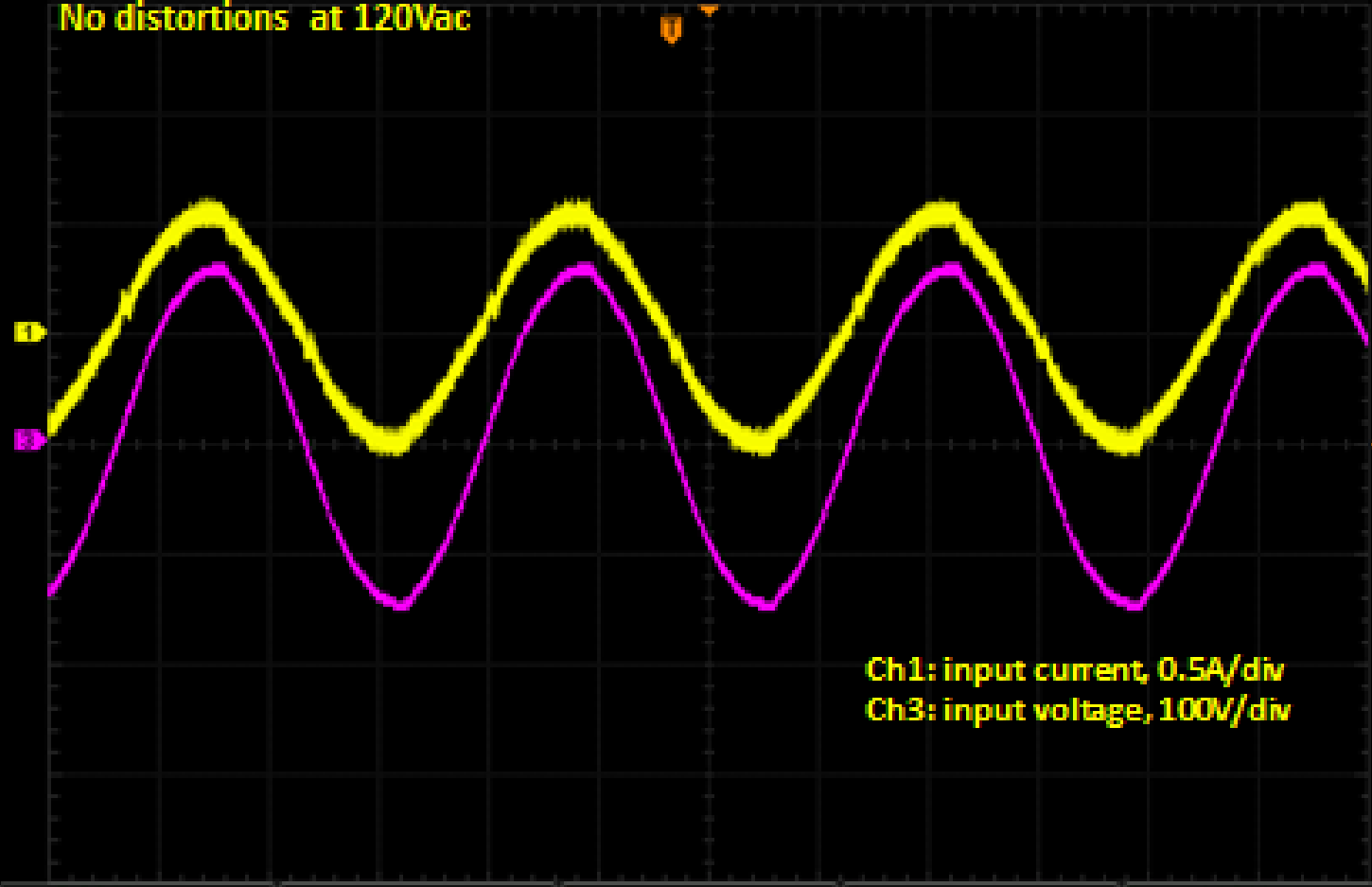

- Coupling: DC
- BW Limit: 20M
- Probe: 100X
- Invert: ON
- Volts/Div: Coarse
- Unit: [V]

Avg=7.88 V Avg=..... Freq=..... Vpp=..... Rms=119 V

- 1 = 500mA
- 2 = 2.00 V
- 3 = 100 V
- 4 = 2.00 V

No distortions at 200Vac input, displacement between current and voltage is probably caused by the input capacitors on EMI filter

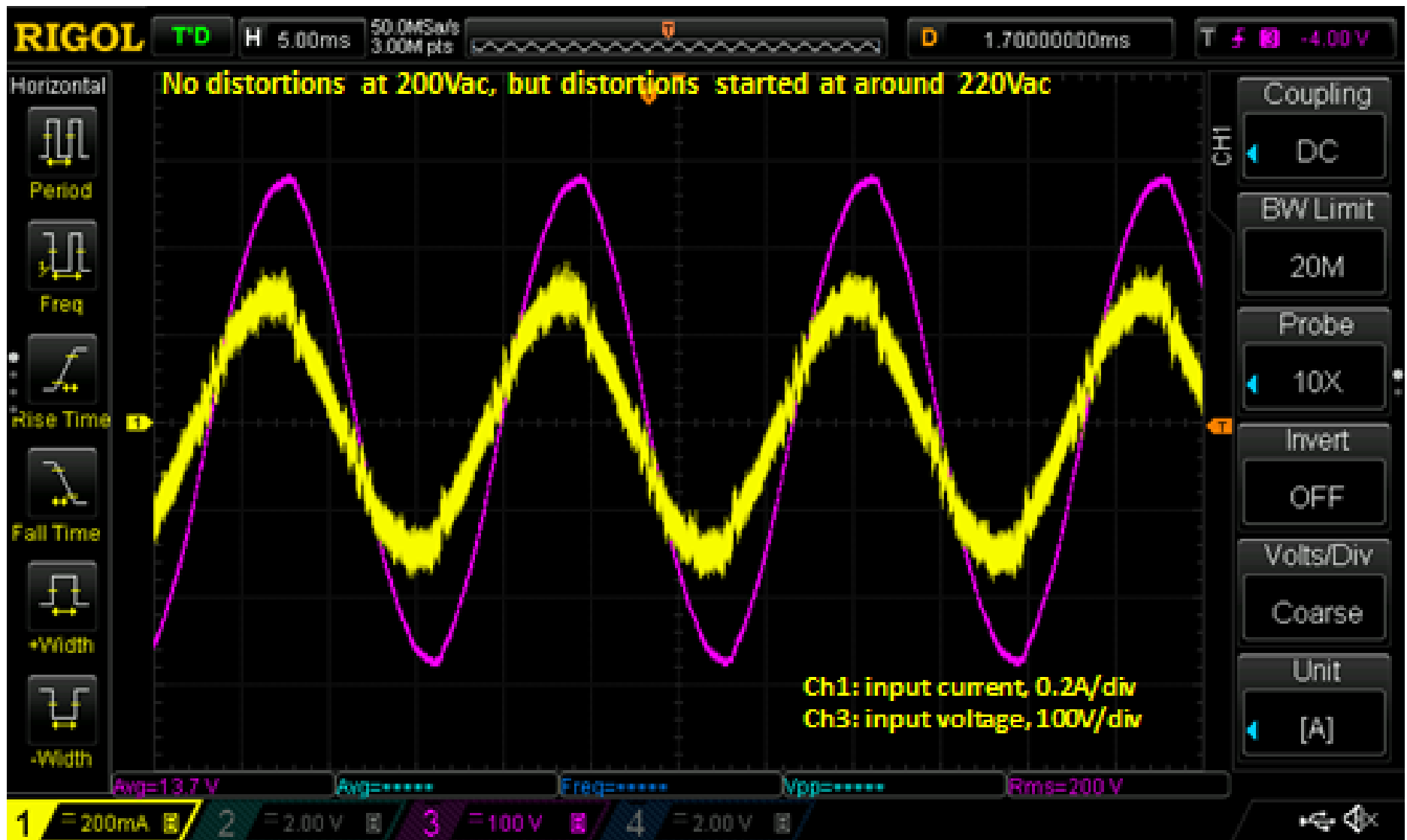

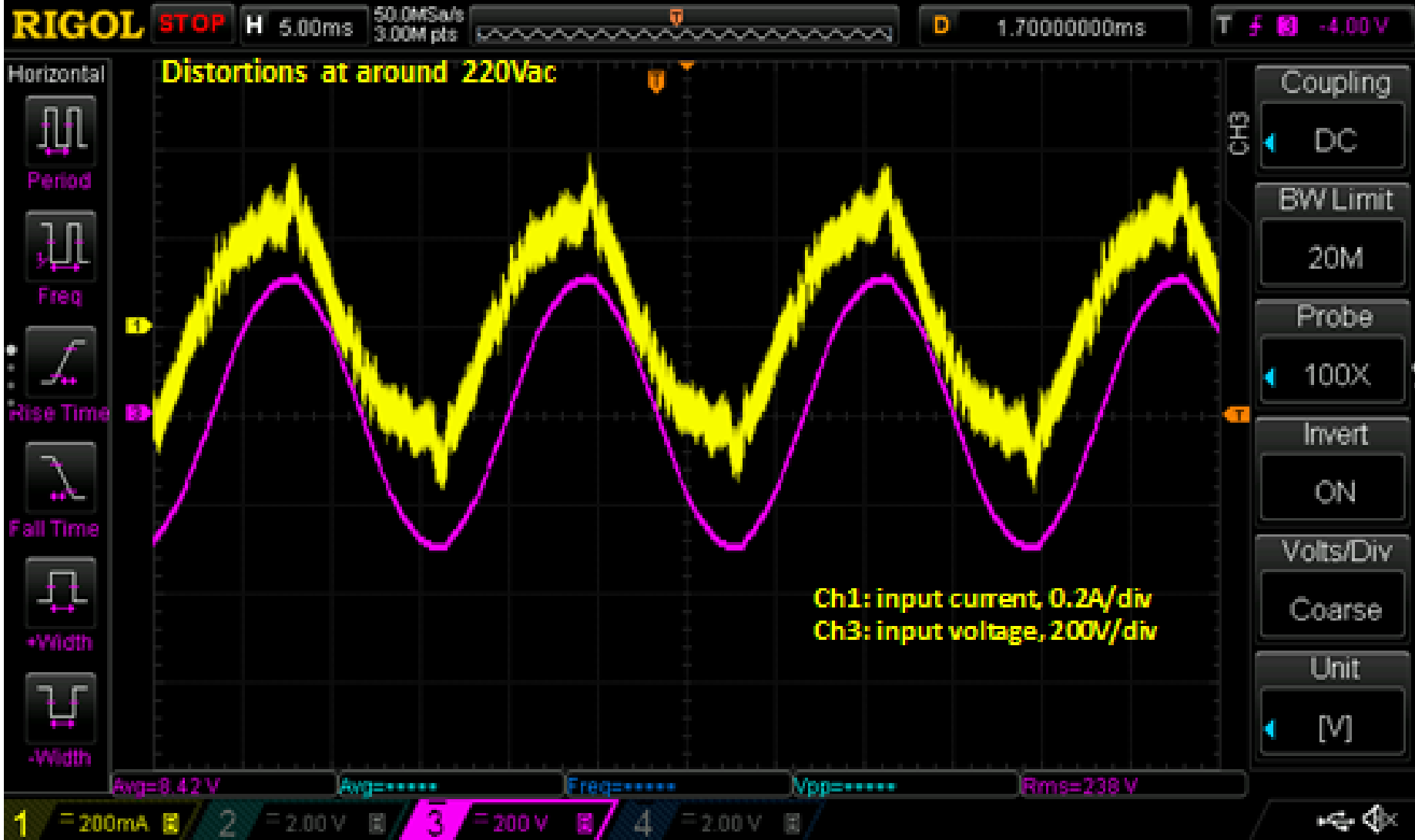

RIGOL

STOP

H 5.00ms

50.0MS/s
3.00M pts



D 2.20000000ms

T f [] -4.00 V

Horizontal

- Period
- Freq
- Rise Time
- Fall Time
- +Width
- Width

Connecting diff probe to COUT (pin15) resulted in more distortions around zero crossing even at 85Vac

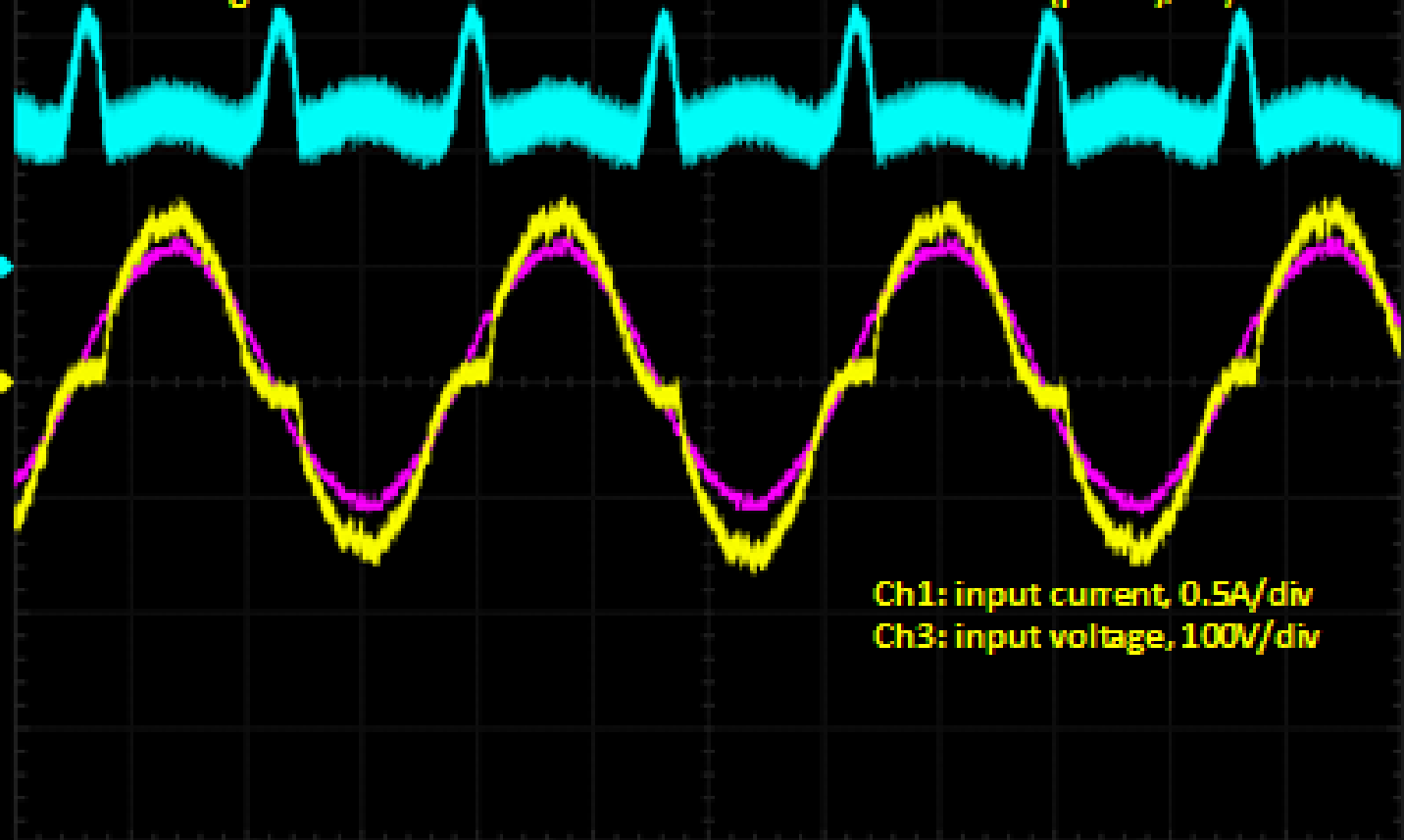

Ch1: input current, 0.5A/div
Ch2: COUT (pin15), 1V/div
Ch3: input voltage, 100V/div

CH2

Coupling
DC

BW Limit
20M

Probe
10X

Invert
OFF

Volts/Div
Coarse

Unit
[V]

Avg=9.92 V Avg=2.66 V Freq=..... Vpp=2.80 V Rms=87.5 V

1 = 500mA 2 = 2.00 V 3 = 100 V 4 = 2.00 V

RIGOL

STOP

H 5.00ms

50.0MSa/s
3.00M pts

D

0.00000000ps

T f \square -4.00V

215Vac input, measuring the ripple on DC link voltage

- Horizontal
- Period
- Freq
- Rise Time
- Fall Time
- +Width
- Width

- Coupling: DC
- BW Limit: 20M
- Probe: 10X
- Invert: OFF
- Volts/Div: Coarse
- Unit: [A]

Ch1: input current, 0.2A/div
Ch3: input voltage, 200V/div

Ch2: DC link, AC coupled, 2V/div
2.96Vpkpk @ 215Vac

Avg=2.10V Avg=78.5mV Freq=..... Vpp=2.96V Rms=212V

1 = 200mA 2 ~ 2.00V 3 = 200V 4 = 2.00V

200Vac input, measuring the ripple on DC link voltage

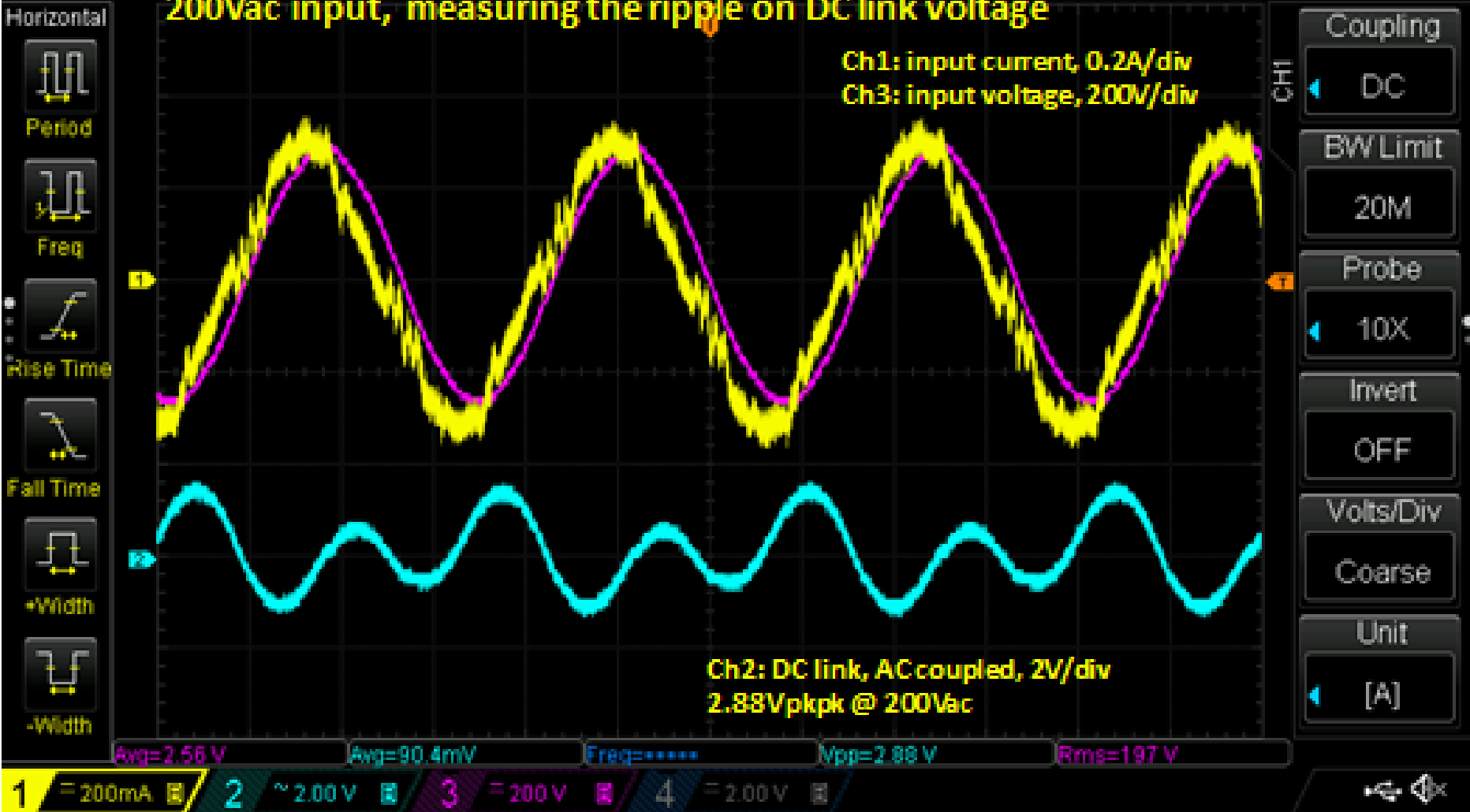

Input voltage (V_{rms})	V_{ff} on pin19 w/ DiffProbe (V_{dc})	V_{aout} on pin1 w/ DVM (V_{dc})
85	1.80	2.000
120	2.56	1.977
150	3.24	1.967
200	4.38	1.933
220	4.81	1.900

$$0 \leq i_{IAC}(t) \leq 500 \mu A,$$

$$0 \leq V_{VAOUT}(t) \leq 5 V,$$

$$1.4 V \leq V_{VFF} \leq V_{VREF} - 1.4 V$$

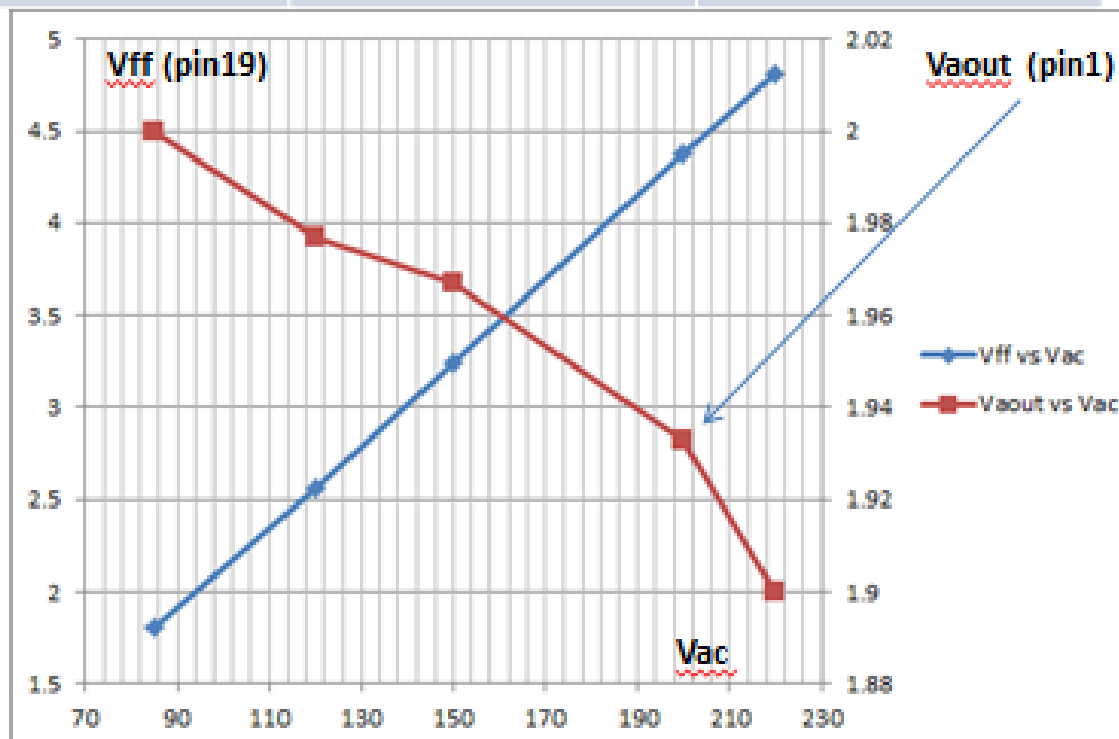

- V_{ff} increases proportionally and V_{aout} drops inversely as V_{ac} increases.
- V_{aout} seems to start low at 2V and not varying within its full range of 0-5V

RIGOL

STOP

H 5.00ms

50.0MSa/s
3.00M pts



D

0.00000000ps

T f -4.00V

Horizontal



Period



Freq



Rise Time



Fall Time



+Width



-Width

85Vac input, $V_{ff}=1.80V$

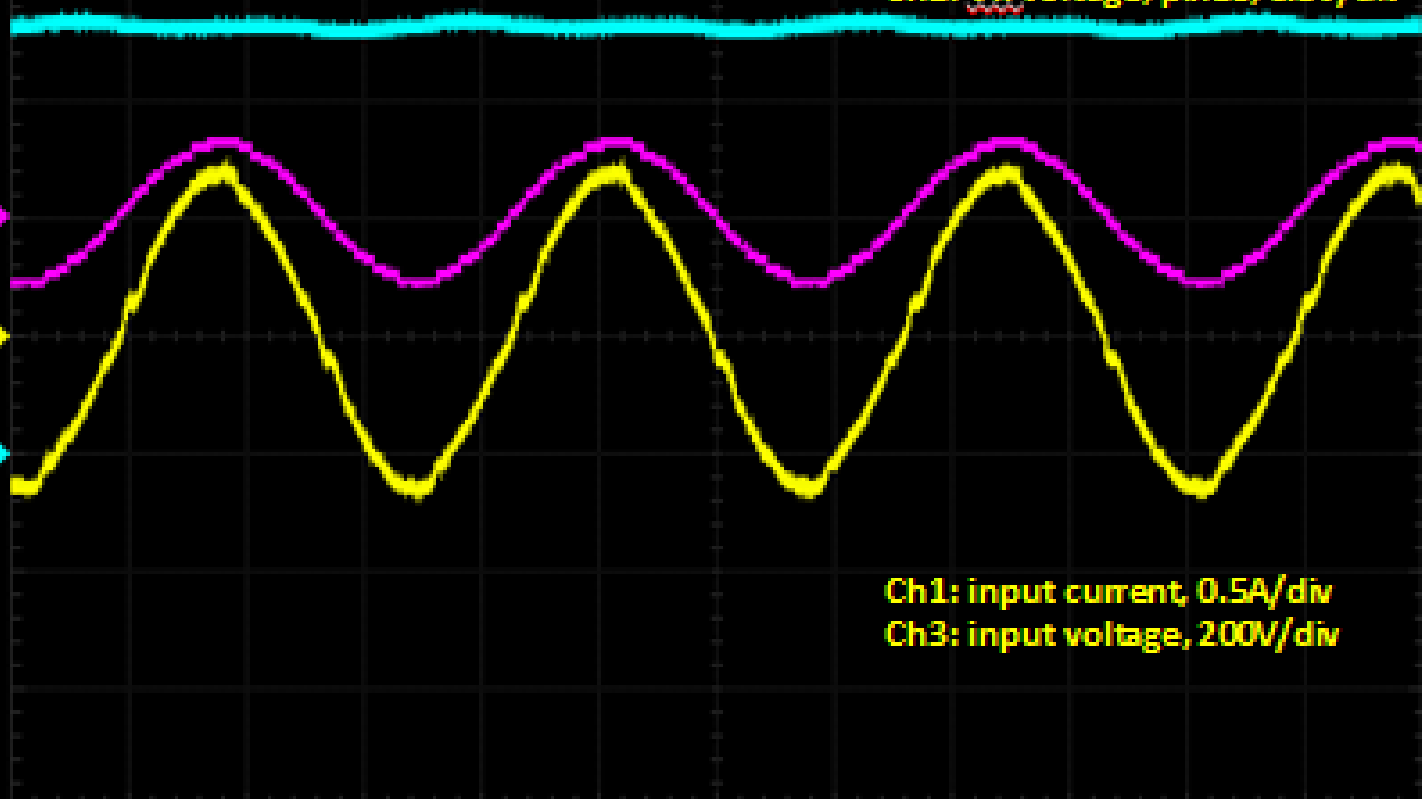

Ch2: V_{ff} voltage, pin19, 0.5V/div

Ch1: input current, 0.5A/div

Ch3: input voltage, 200V/div

CH2

Coupling

DC

BW Limit

20M

Probe

10X

Invert

OFF

Volts/Div

Coarse

Unit

[V]

Rms=85.3 V Rms=466mA Avg=5.60 V Avg=1.80 V Freq=.....

1 = 500mA 2 = 500mV 3 = 200 V 4 = 2.00 V



RIGOL

STOP

H 5.00ms

50.0MSa/s
3.00M pts

D 0.000000000ps

T f -4.00V

Horizontal

- Period
- Freq
- Rise Time
- Fall Time
- +Width
- Width

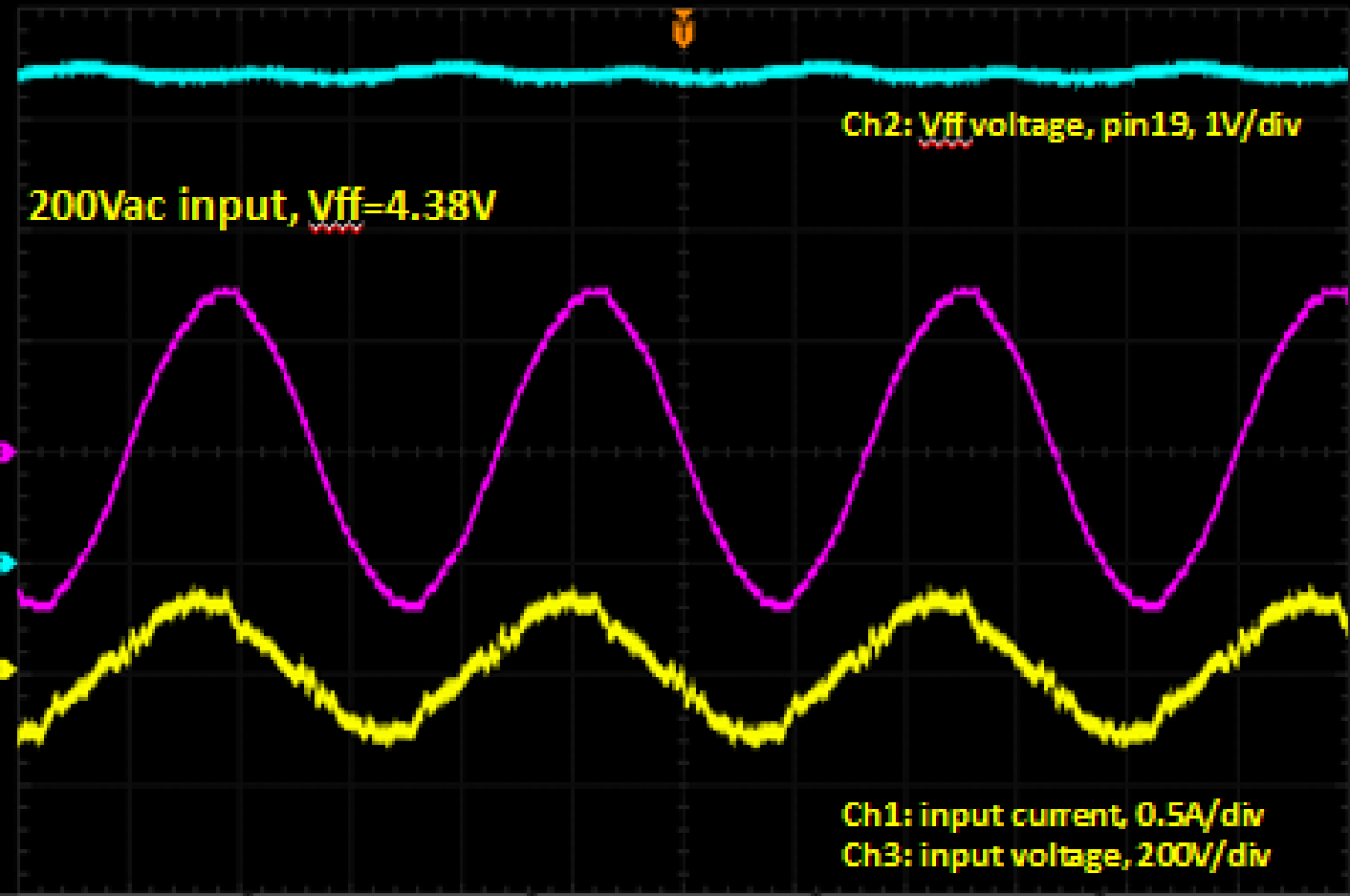

CH2

Coupling
DC

BW Limit
20M

Probe
10X

Invert
OFF

Volts/Div
Coarse

Unit
[V]

Rms=200 V Rms=207mA Avg=-729mV Avg=4.38 V Freq=.....

1 = 500mA 2 = 1.00 V 3 = 200 V 4 = 2.00 V



RIGOL

STOP

H 5.00ms

50.0MSa/s
3.00M pts

D 0.00000000ps

T f -4.00V

Horizontal



Period



Freq



Rise Time



Fall Time



+Width



-Width

220Vac input, $V_{ff}=4.73V$
Distortion starts

Ch2: V_{ff} voltage, pin19, 2V/div

Ch1: input current, 0.2A/div
Ch3: input voltage, 200V/div

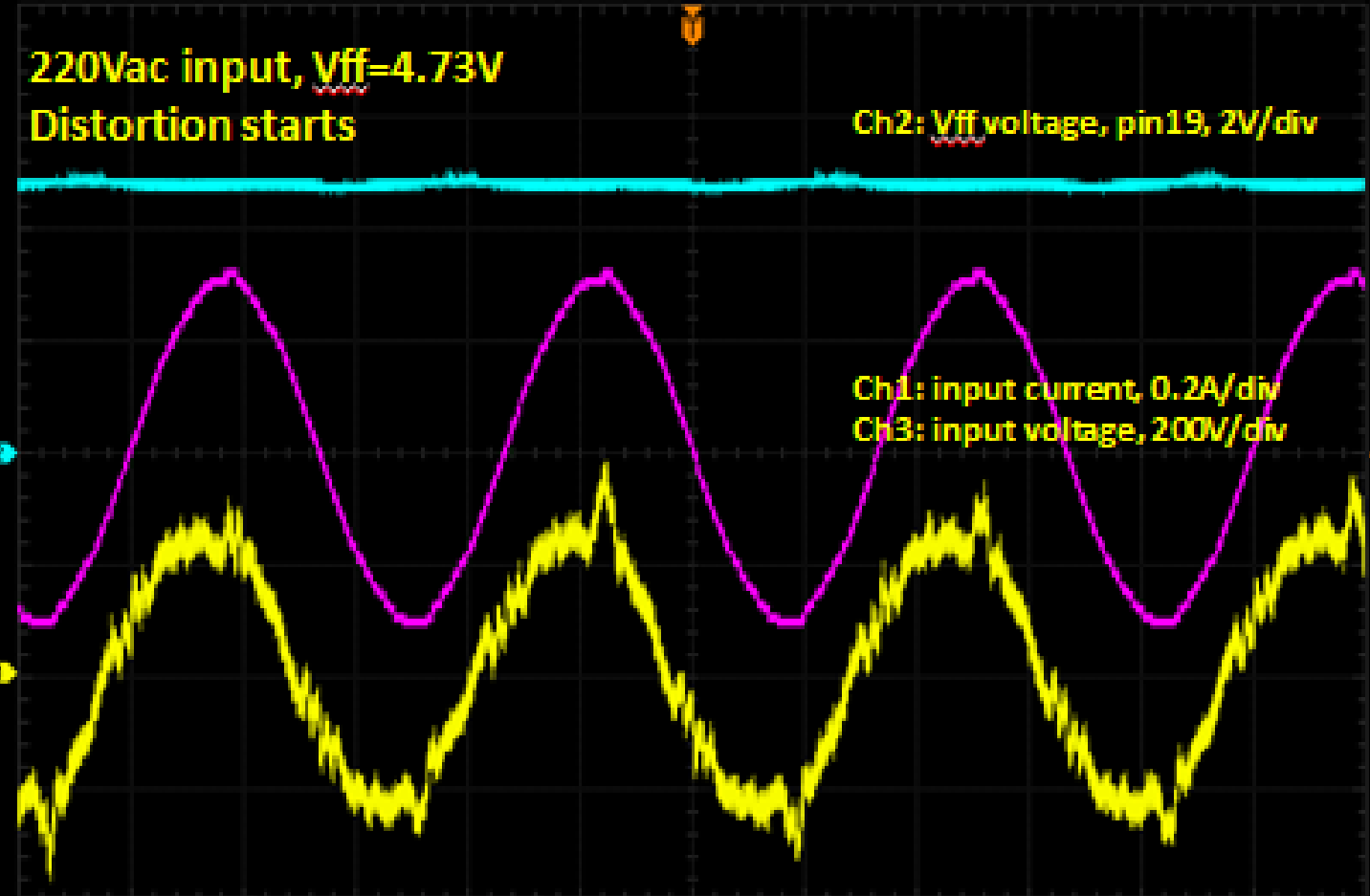

CH1

Coupling
DC

BW Limit
20M

Probe
10X

Invert
OFF

Volts/Div
Coarse

Unit
[A]

Rms=219 V Rms=186mA Avg=-475mV Avg=4.73 V Freq=*****

1 = 200mA 2 = 2.00 V 3 = 200 V 4 = 2.00 V

At the peak of sinewaves when distortion starts, the duty cycle of boost MOSFET is about 15%

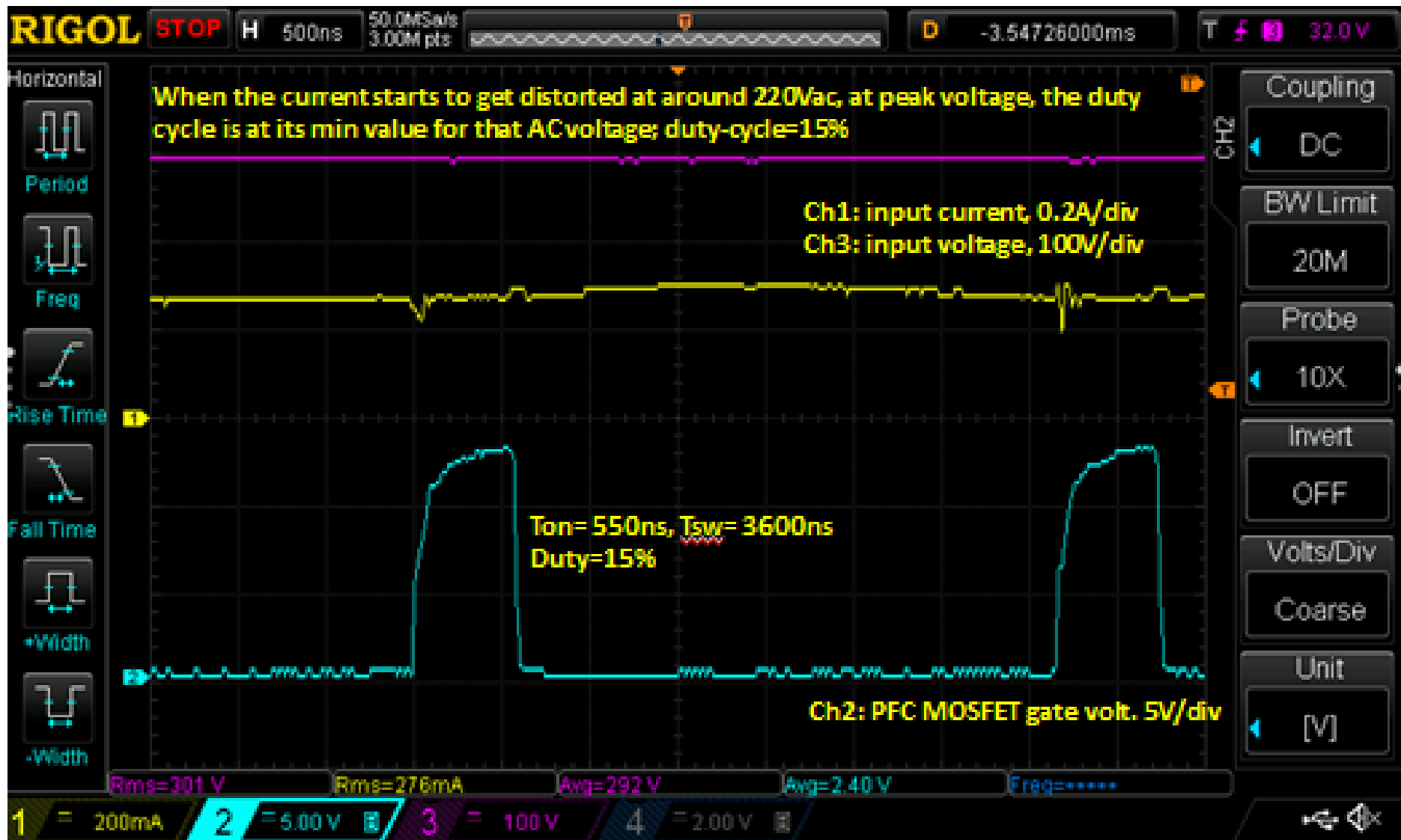

At the peak of sinewaves at 120Vac, the duty cycle of boost MOSFET is about 54%

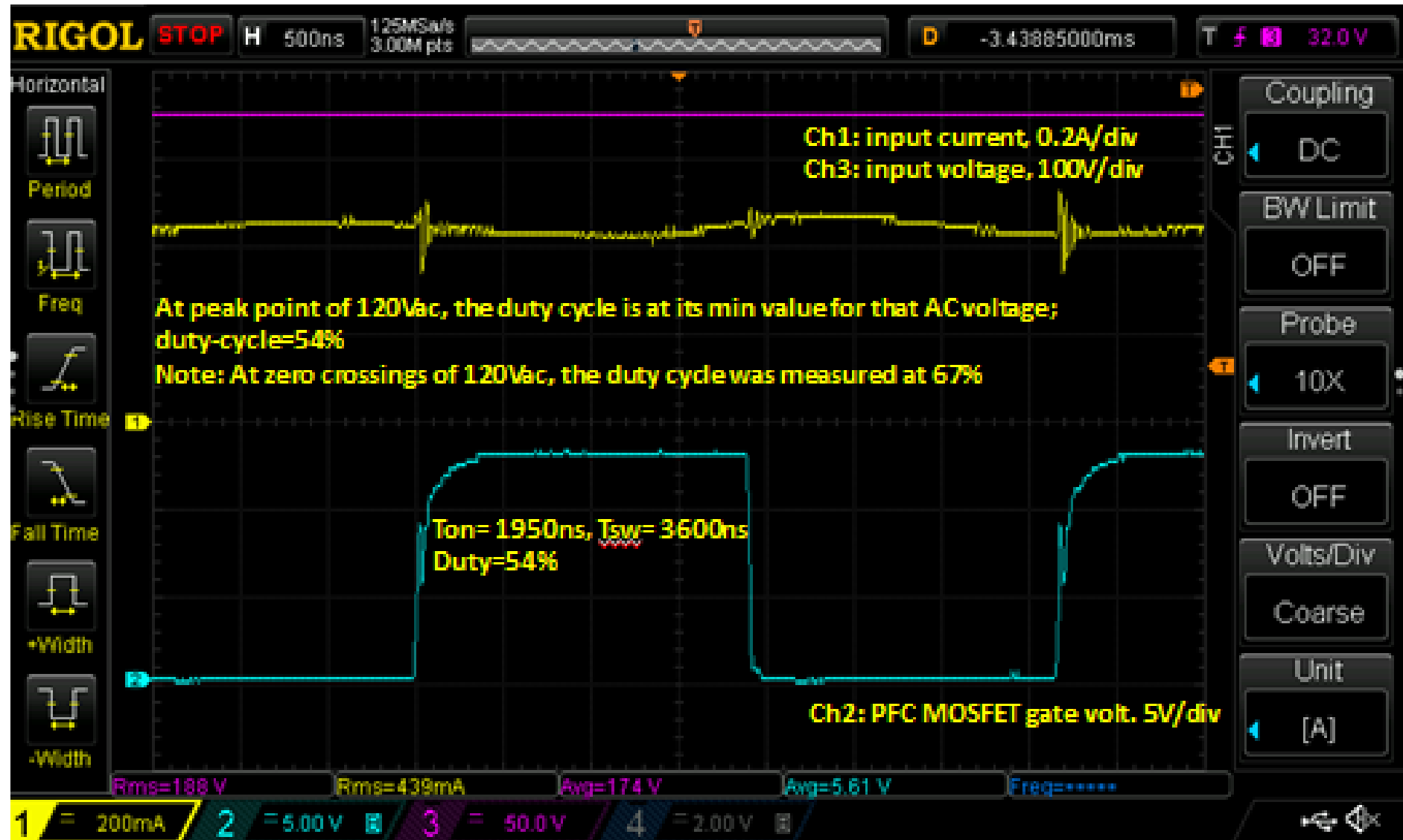

At 220Vac when distortions starts, the rectified input voltage (used for Vff) is shown below

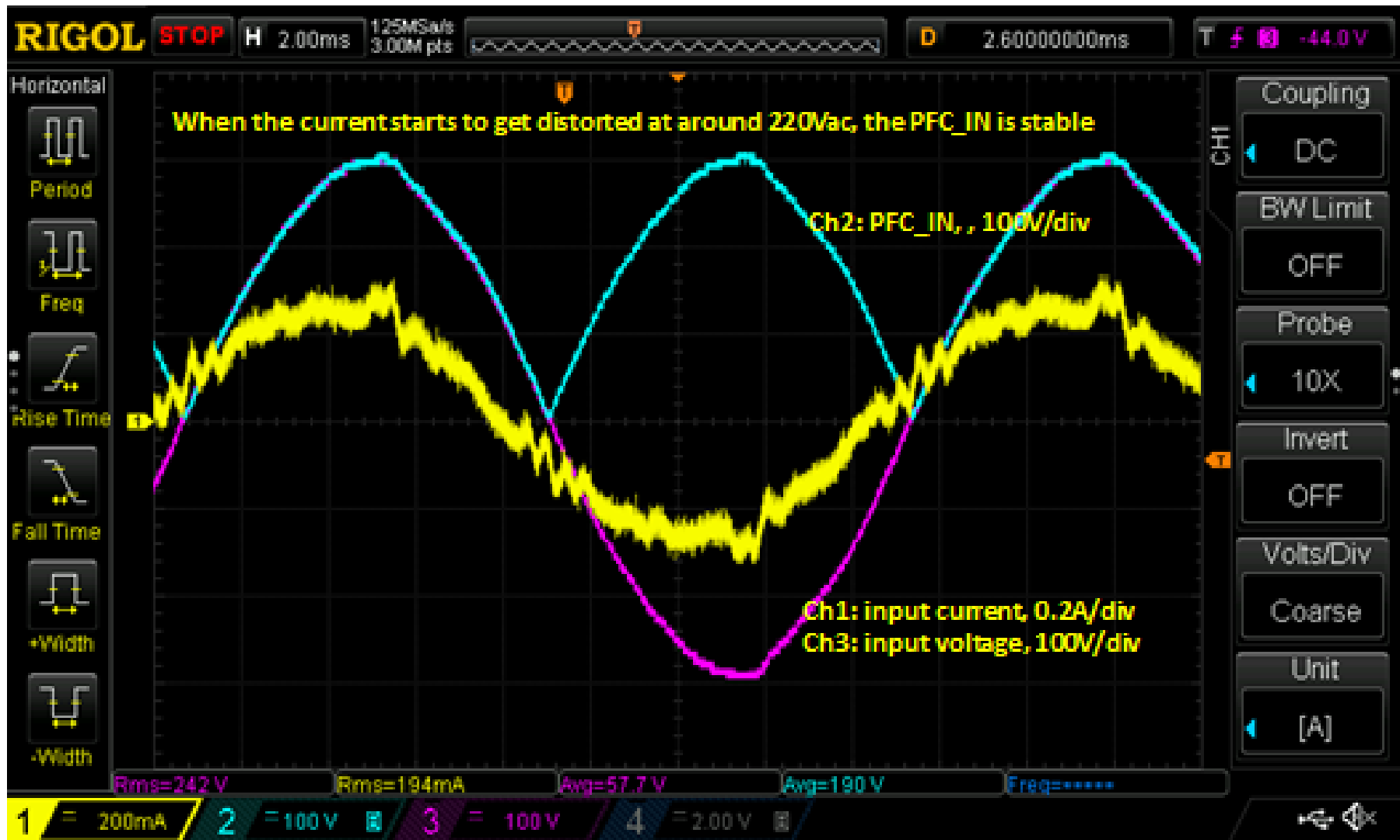

Referring to Fig 36 in the data sheet of UCC28513DW, what specific capacitor controls the min duty cycle?

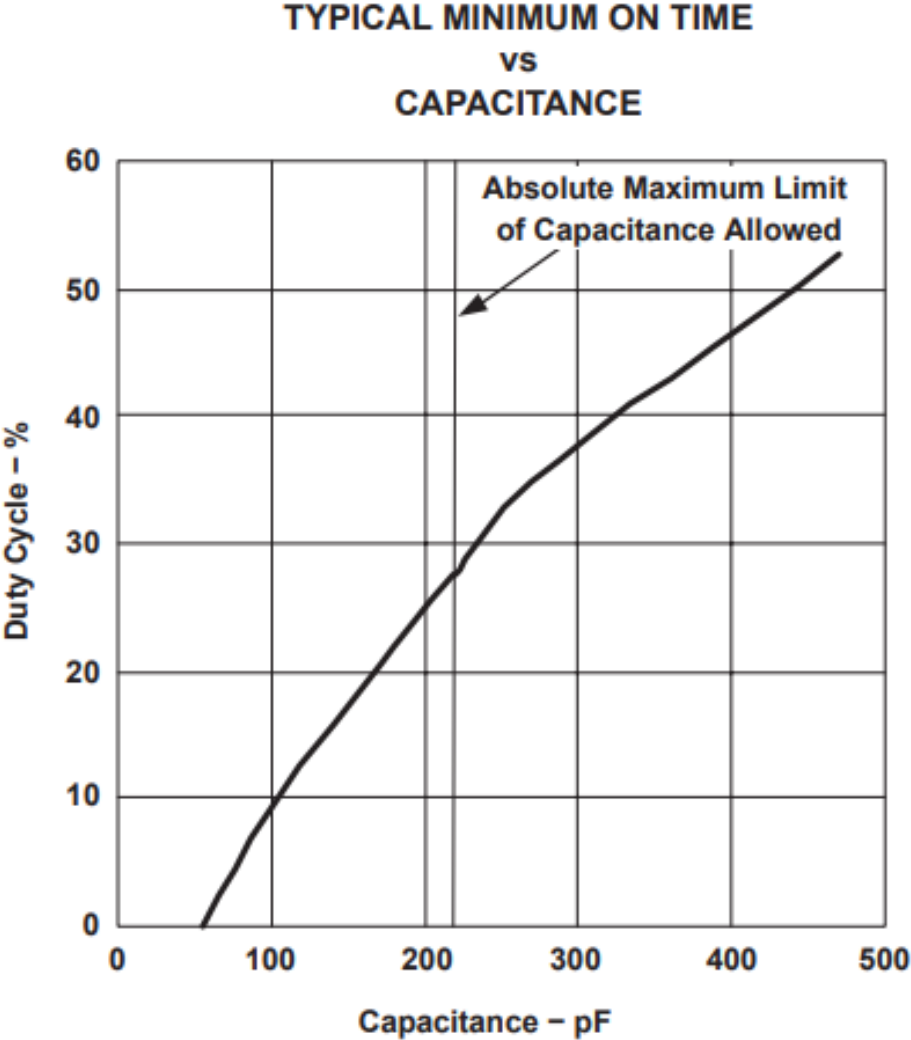

Note: The capacitor on Isense2 affects the min duty cycle on GATE2 output, PFC is on GATE1 output

Figure 36

Boost inductor is changed from 660uH to $2 \times 660\mu\text{H} = 1.32\text{mH}$

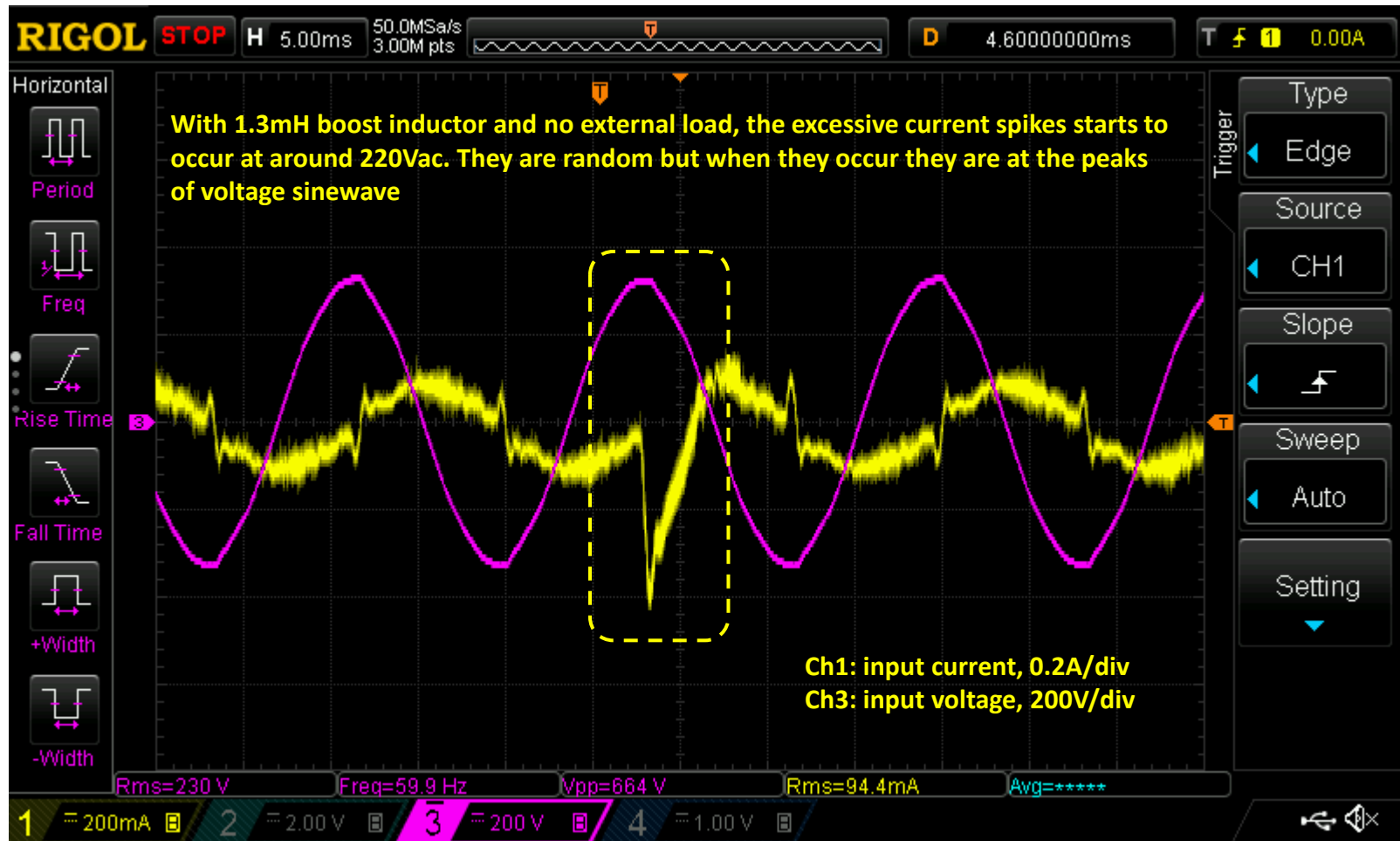

Boost inductor is changed from 660uH to $2 \times 660\text{uH} = 1.32\text{mH}$



Boost inductor is changed from 660uH to $2 \times 660\mu\text{H} = 1.32\text{mH}$

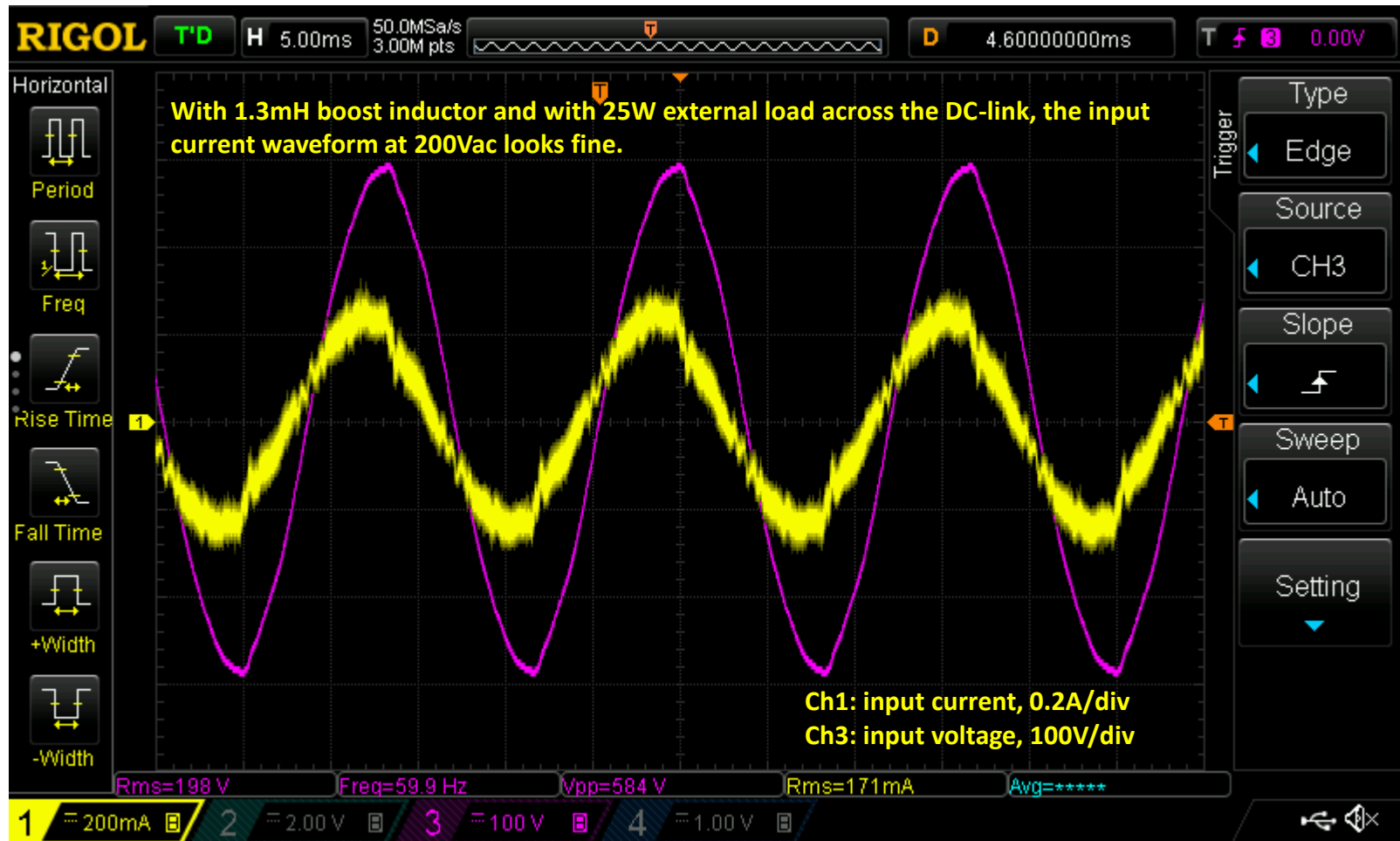

Boost inductor is changed from 660uH to $2 \times 660\mu\text{H} = 1.32\text{mH}$

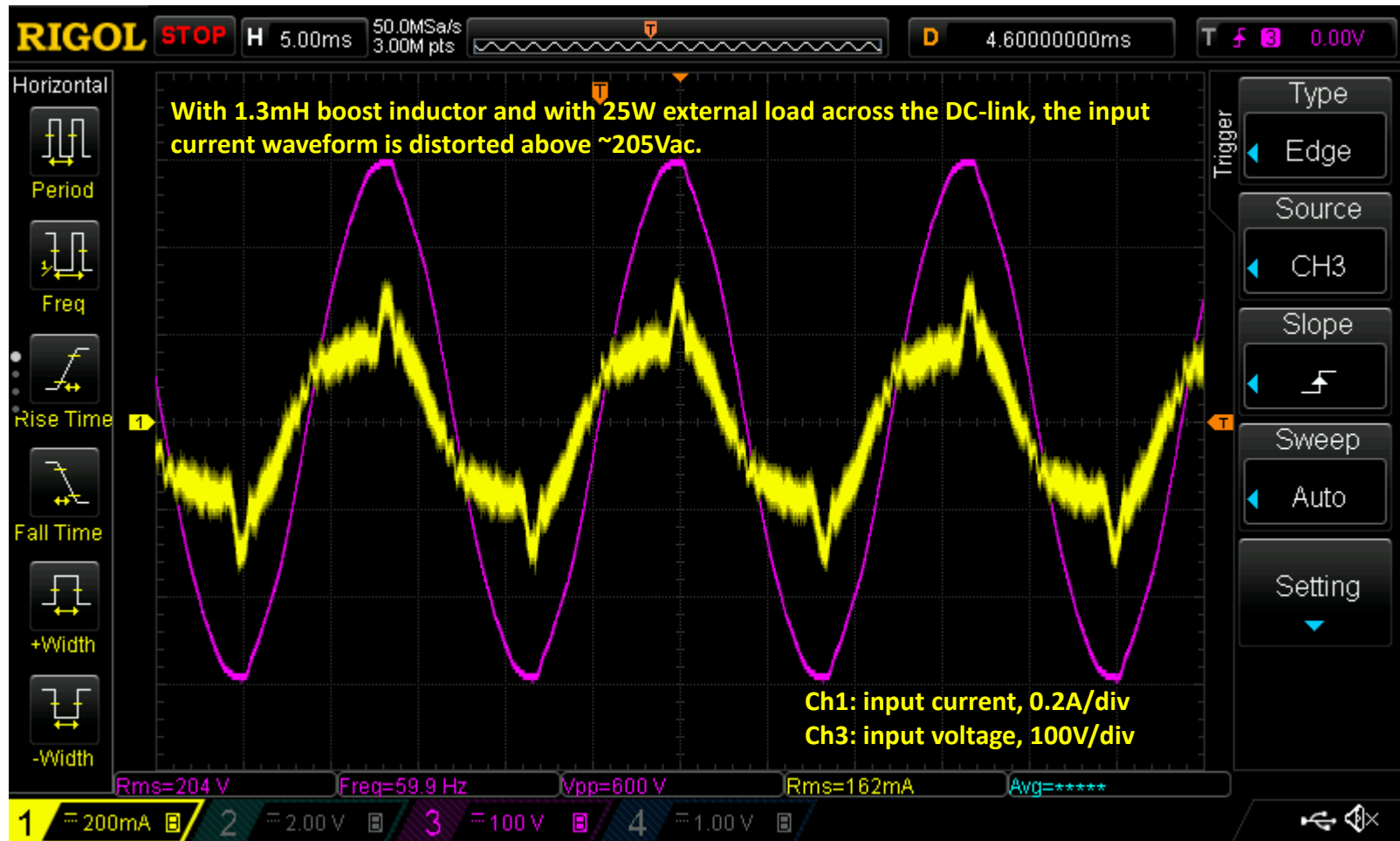

Boost inductor is changed from 660uH to $2 \times 660\mu\text{H} = 1.32\text{mH}$

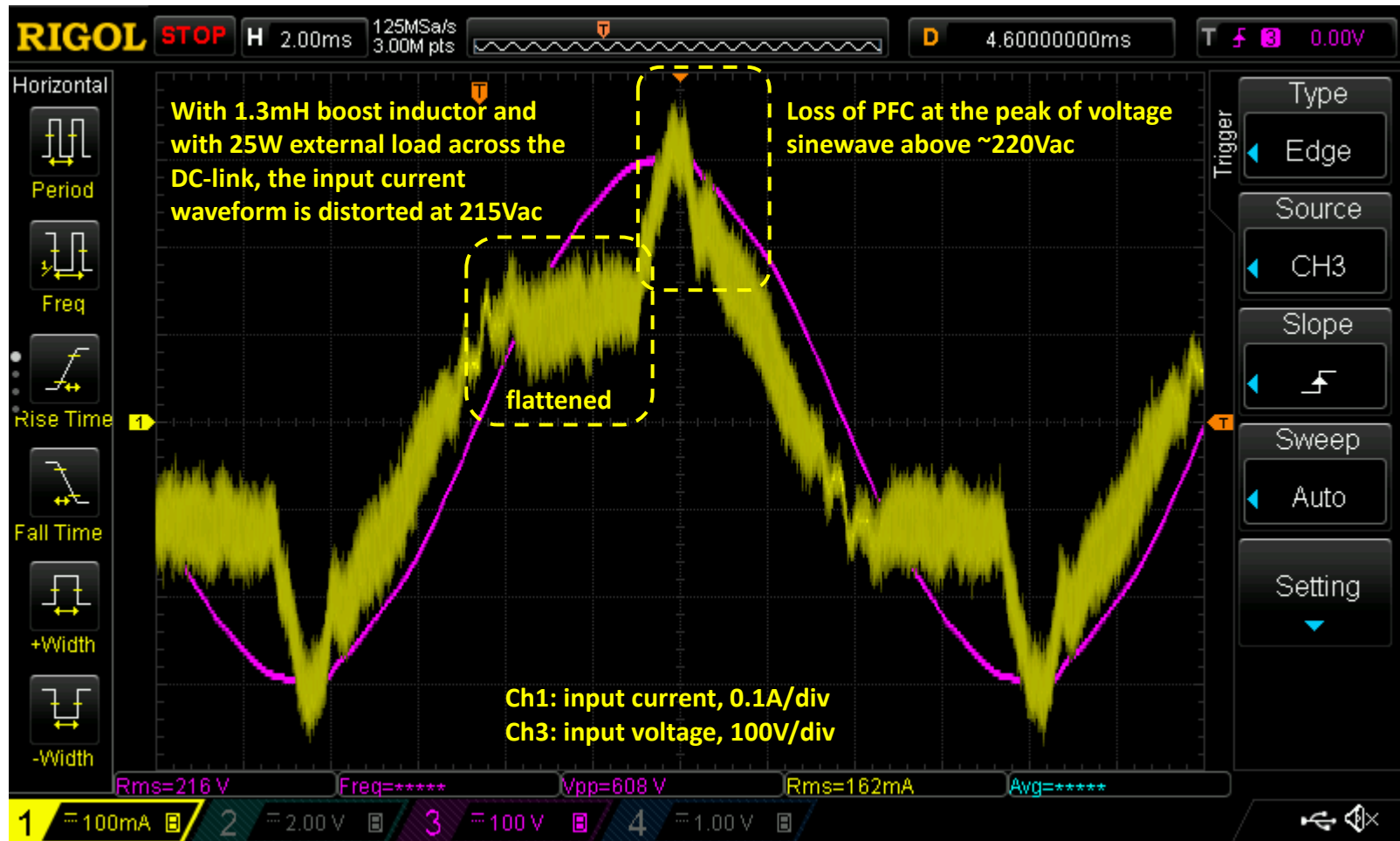

RefDes on data sheet	RefDes in design	values	Values on 12/11/2022
R1	R47+R50	766K	
R2	R43	0.22	0.44
R8/R12	R4/R9	3.16K	2.74K
R3	R44+R49	1124K	
R4	R60	22.1k	
C1	C32	150uF	
L1	L2	660uH	
R13	R10	15.8K	55K (56K//3.3Meg)
C6	C6	680pF	233pF (200p//33p)
C7	C8	150pF	33pF
R15	R11	30.1K	
C8	C9	4.7uF	
C10	C1	1.5uF	
C11	C2	150nF	
R21	R1	48.7K	
R14	R13	10K	
R7	R5	1.18K	1.50K (3.3K//2.74K)
C9	C4	1uF	

Changes made on 12/11 are highlighted

← **Also tried 15.8k**

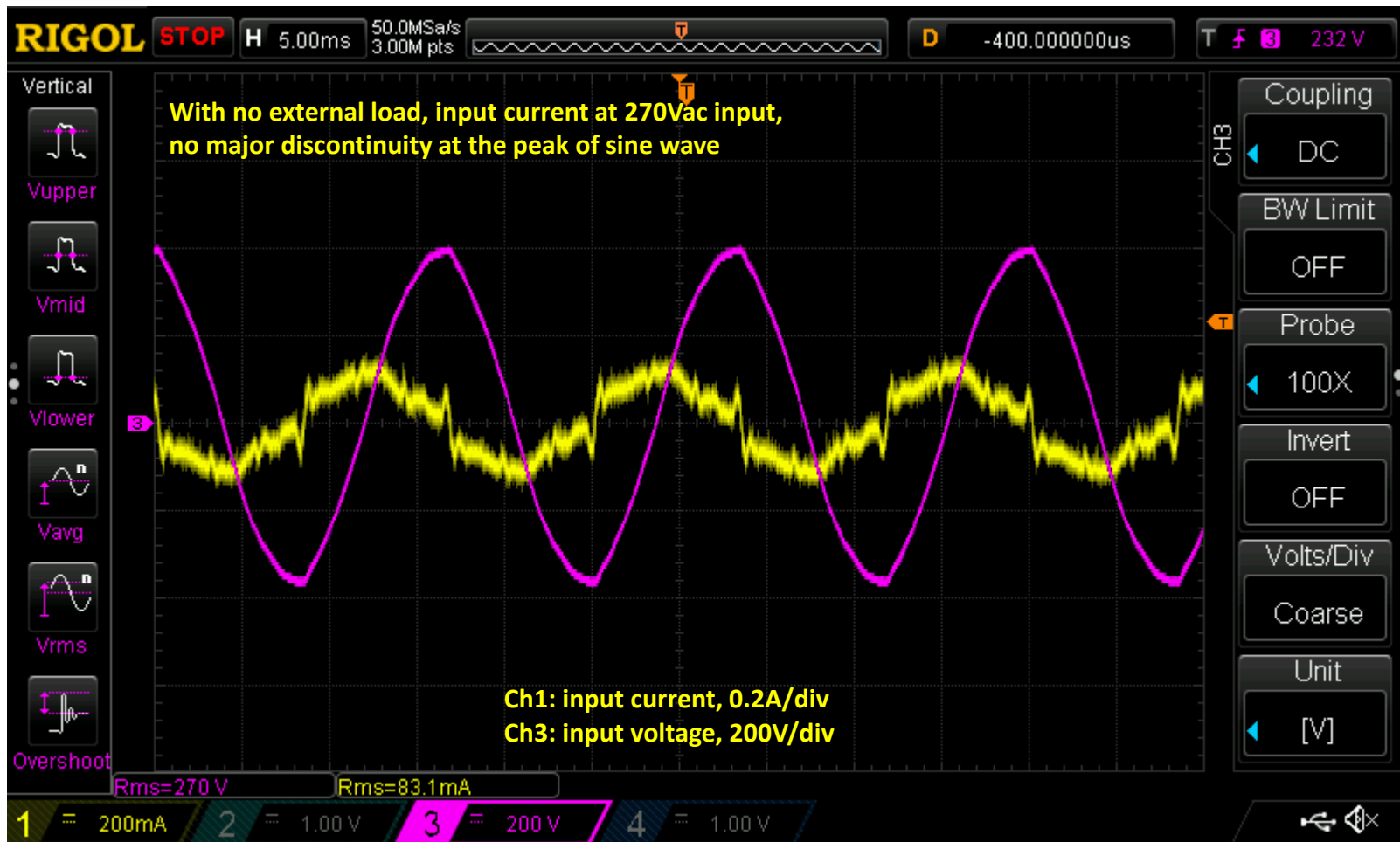

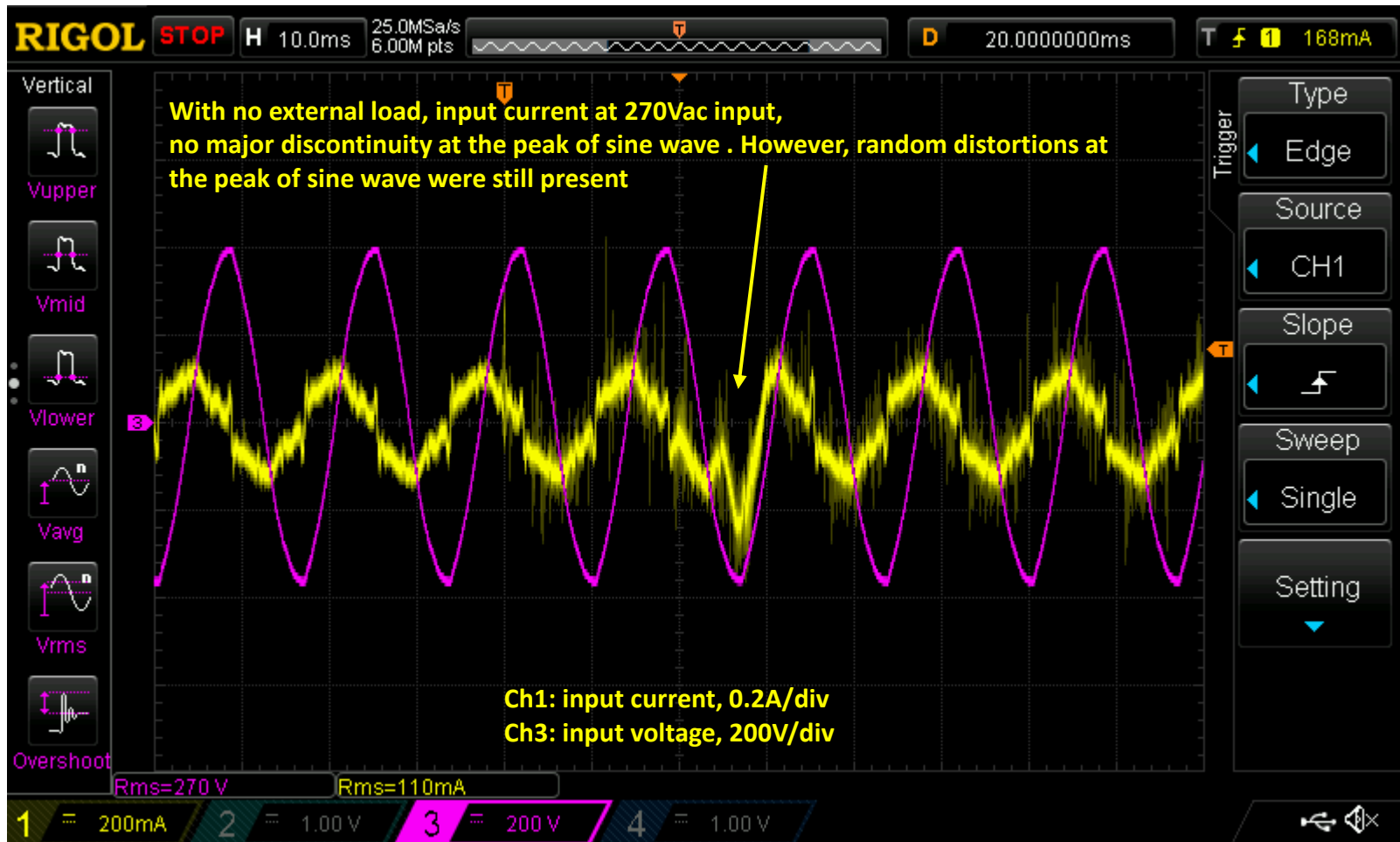

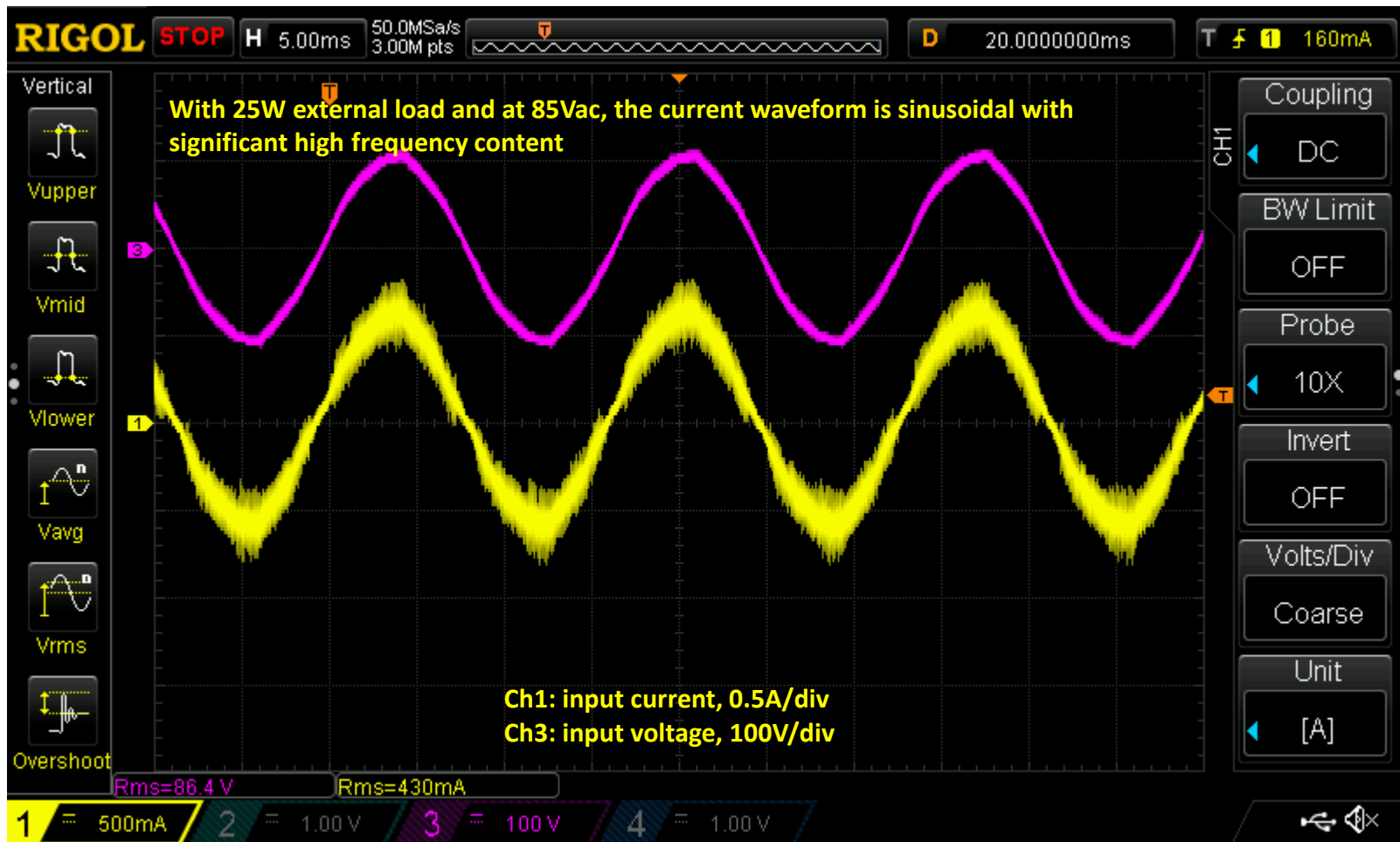

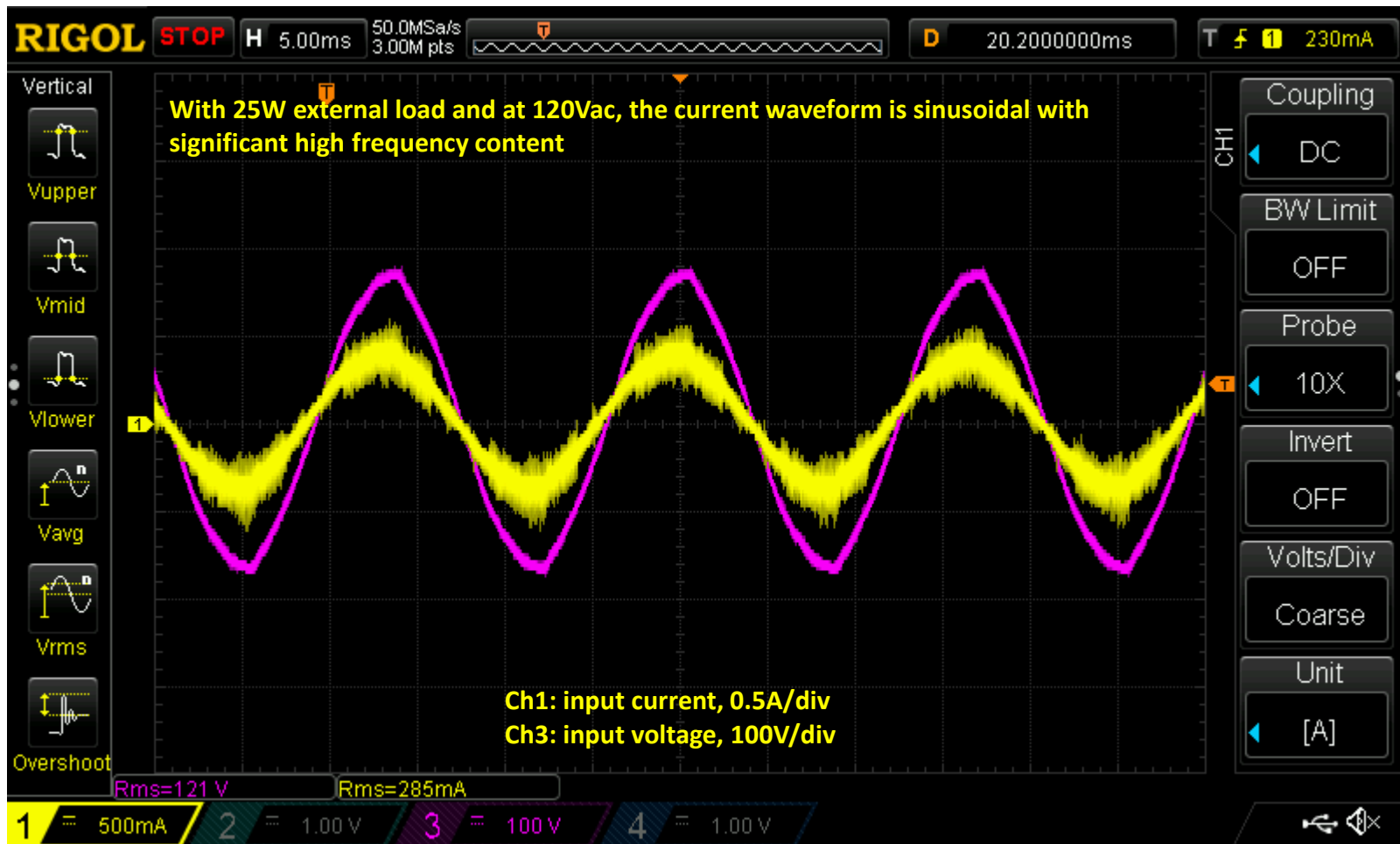

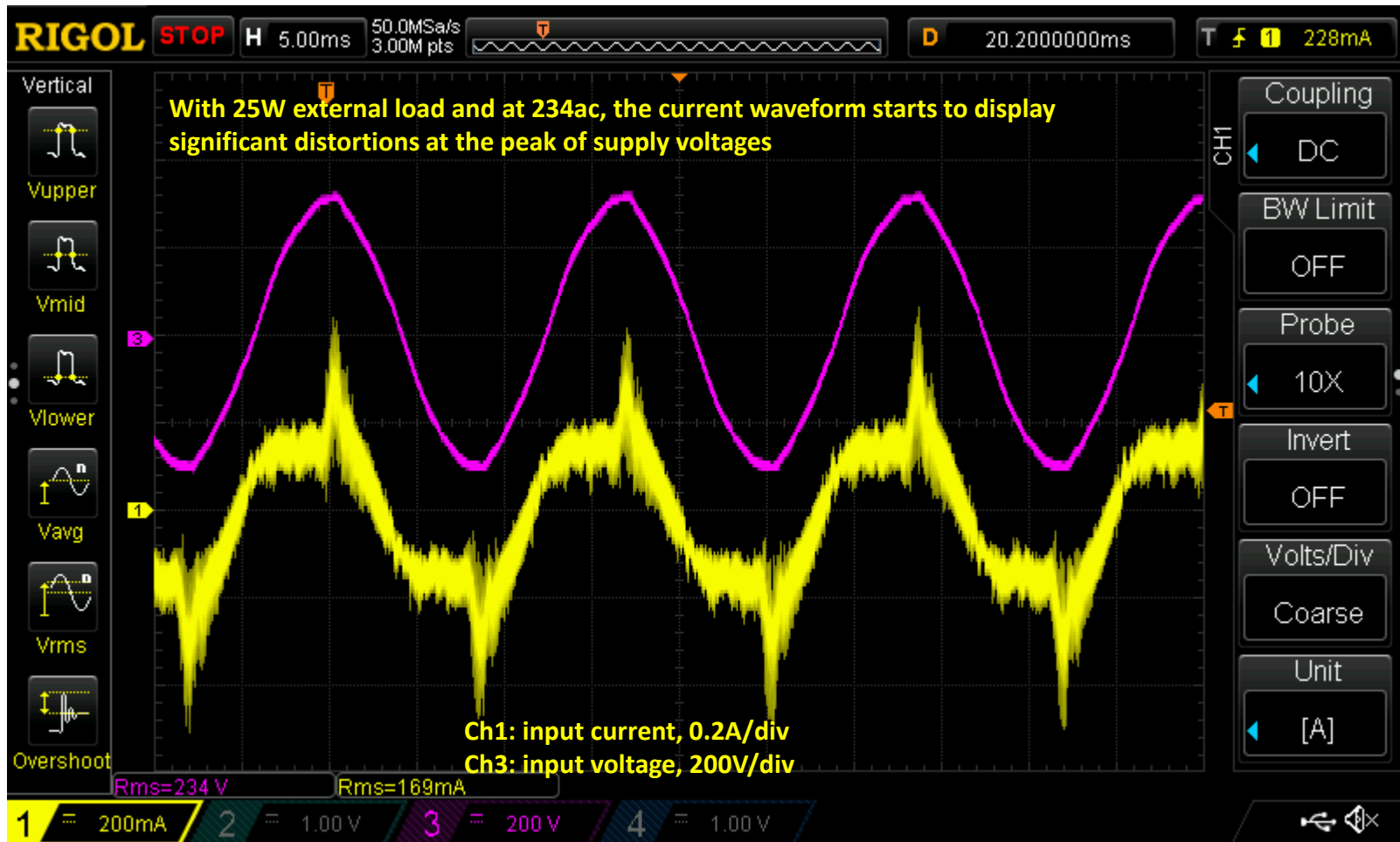

There are only two current probes at the moment:

Ch1: Fluke 80i-110S has limited bandwidth and is used to measure 60Hz input current only.

Ch4: Rogowski probe, CWTUM-015-B, is used to measure the high frequency switching ripple only.

In addition, a $100\text{m}\Omega$ and $20\text{m}\Omega$ sense resistor was connected in series with inductor and the voltage across the resistor was measured with a differential probe. However, doing so resulted in further instability and distortion and therefore abandoned.

Measuring inductor current vs gate voltages, 12/18

Ch1: Current probe is Fluke 80i-110S, which has limited bandwidth and is used to measure 60Hz input current

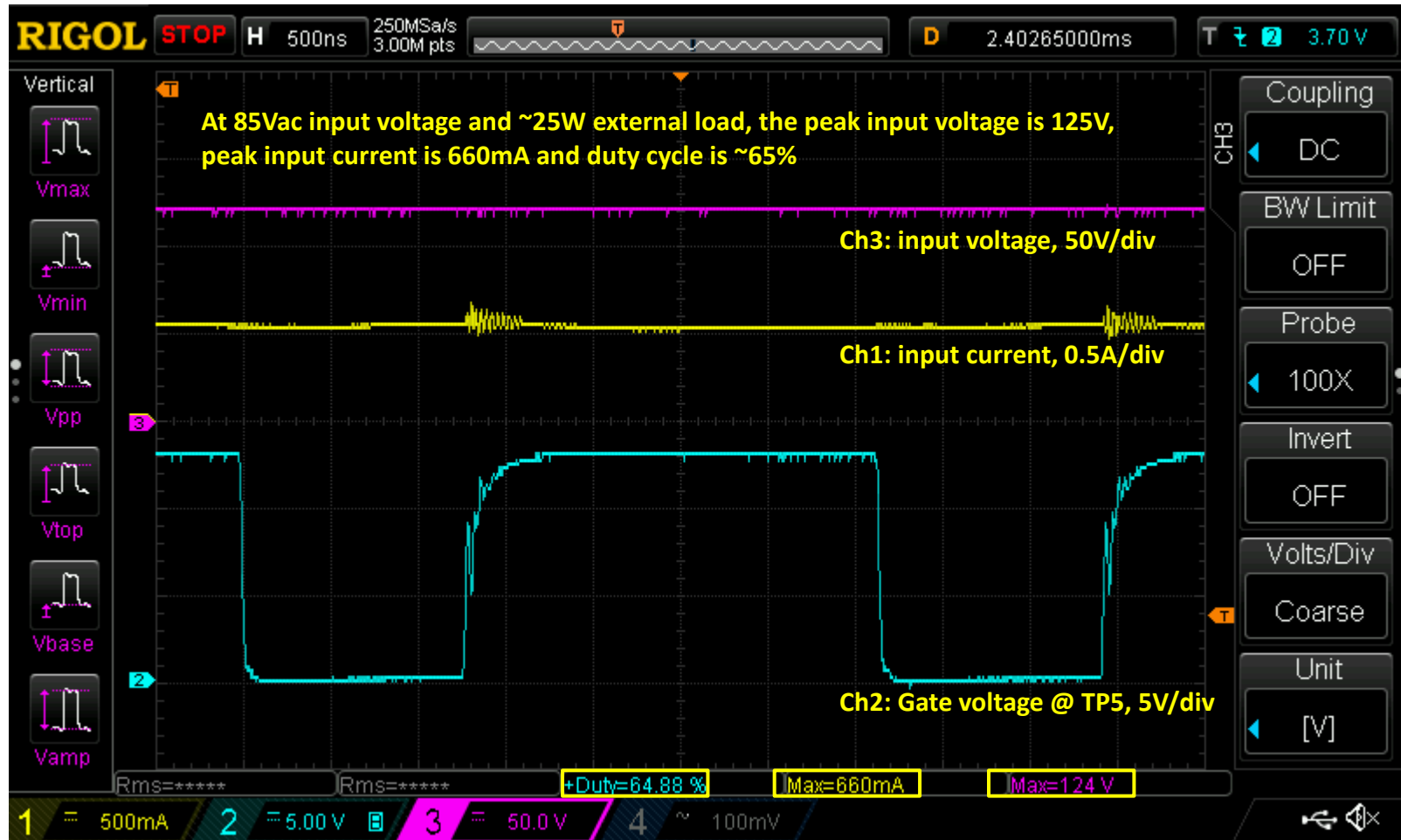

Measuring inductor current vs gate voltages, 12/18

Ch1: Current probe is Fluke 80i-110S, which has limited bandwidth and is used to measure 60Hz input current

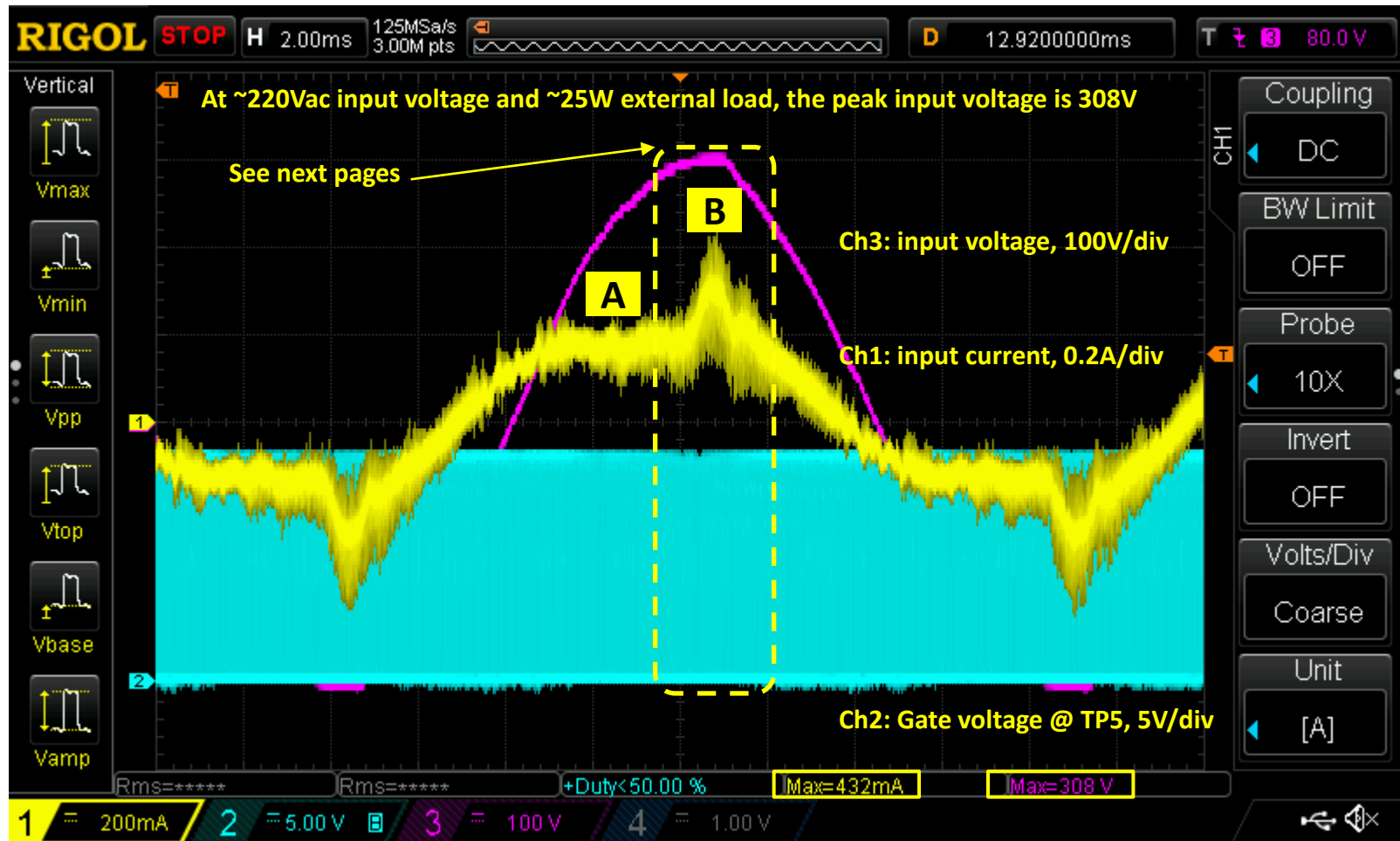

Measuring inductor current vs gate voltages, 12/18

Ch1: Current probe is Fluke 80i-110S, which has limited bandwidth and is used to measure 60Hz input current

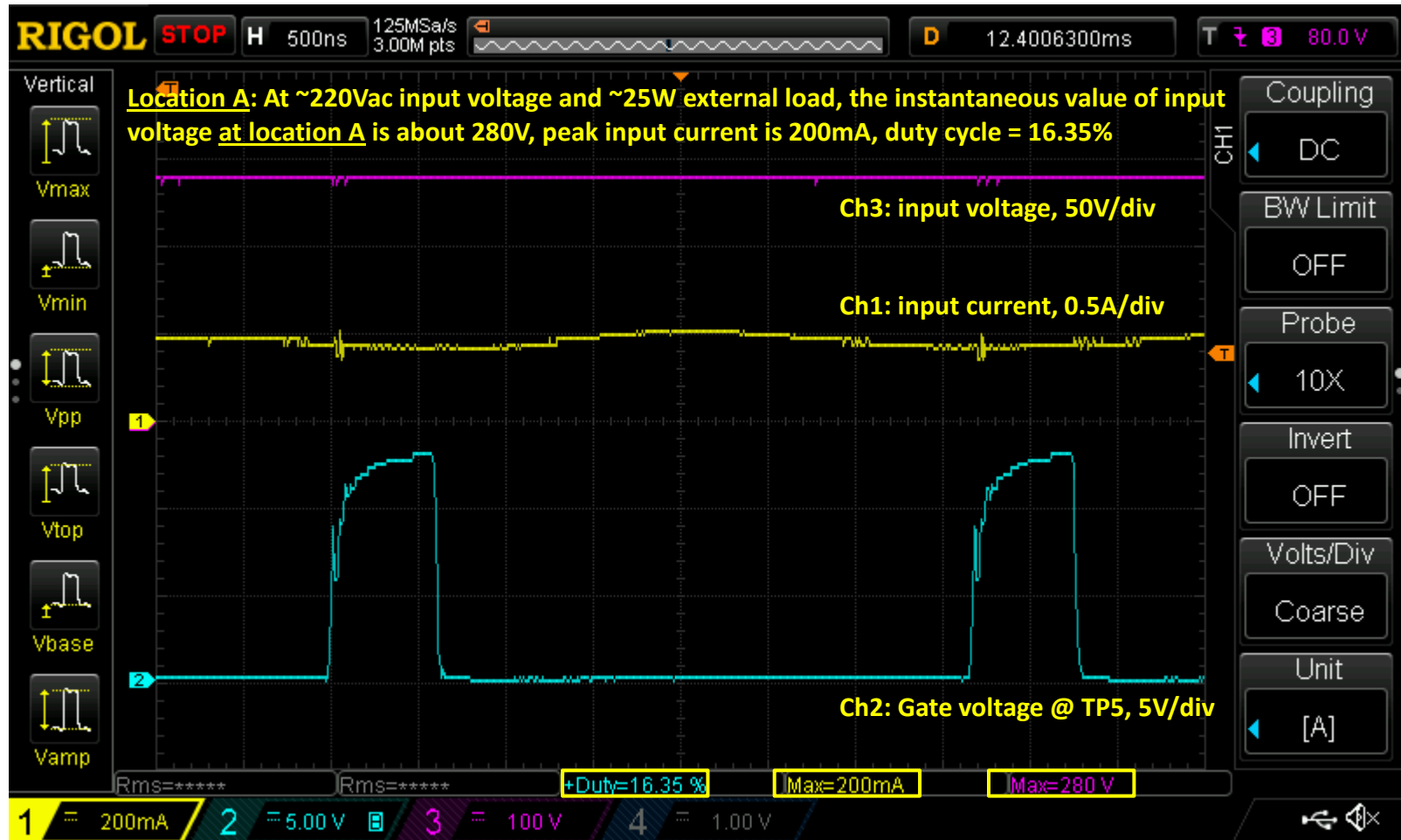

Measuring inductor current vs gate voltages, 12/18

Ch1: Current probe is Fluke 80i-110S, which has limited bandwidth and is used to measure 60Hz input current

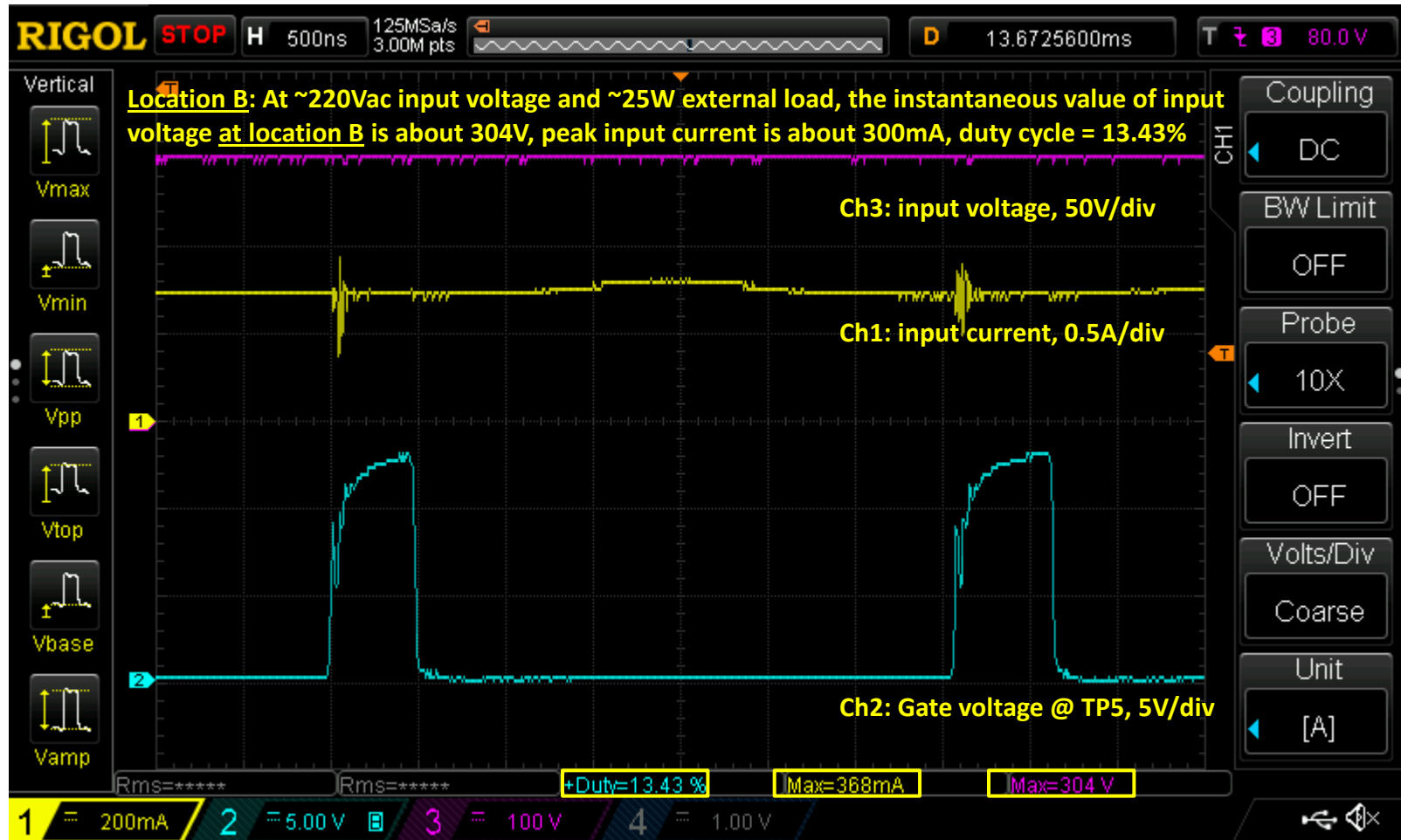

Measuring inductor current vs gate voltages, 12/18

Ch1: Current probe is Fluke 80i-110S, which has limited bandwidth and is used to measure 60Hz input current

Ch4: Current probe is Rogowski CWTUM-015-B, which can measure high frequency only.

At the peak of 85Vac input voltage and ~25W external load, the instantaneous value of input voltage is 132V, peak input current is 660mA, duty cycle = 64.28%

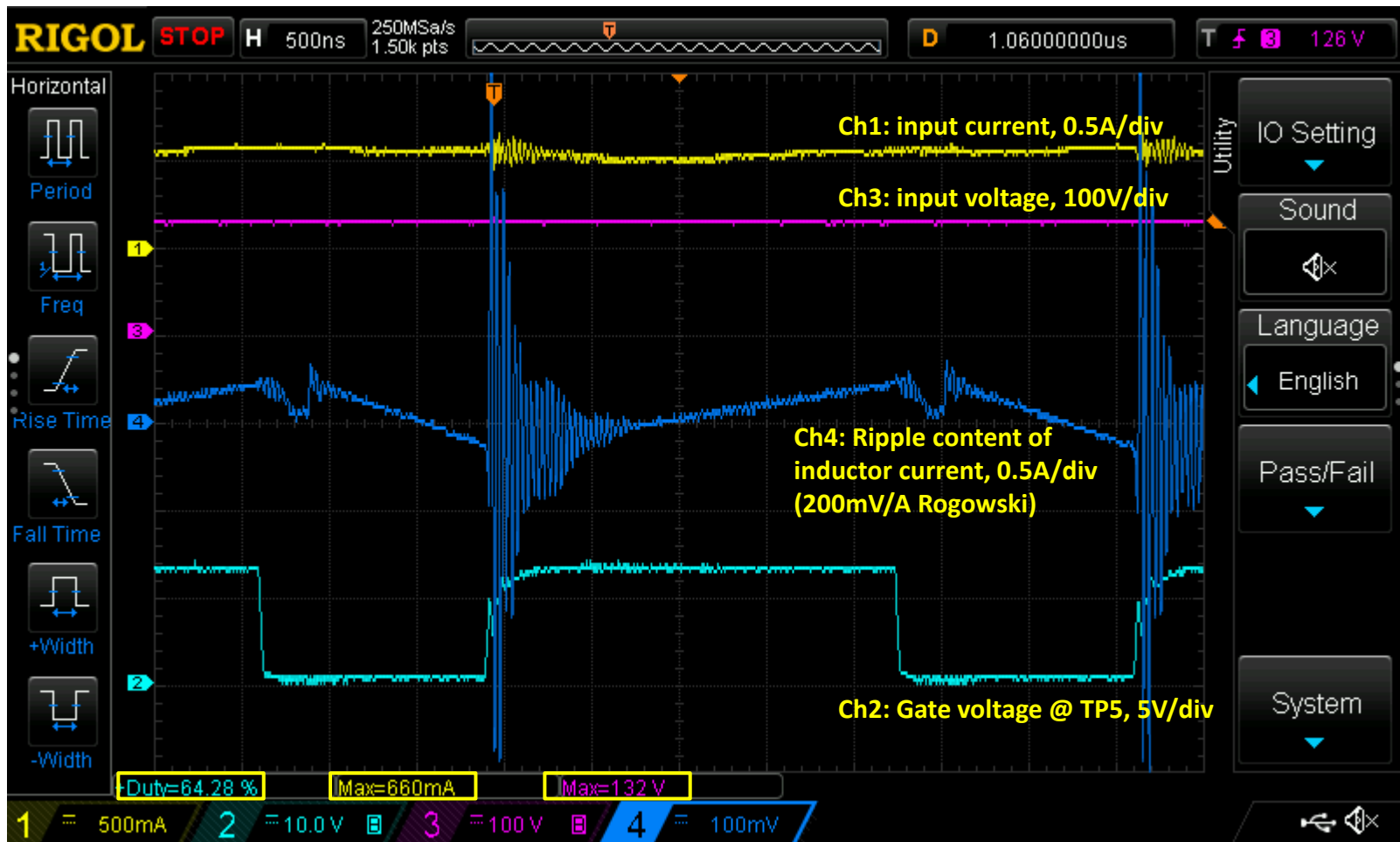

Measuring inductor current vs gate voltages, 12/18

Ch1: Current probe is Fluke 80i-110S, which has limited bandwidth and is used to measure 60Hz input current

Ch4: Current probe is Rogowski CWTUM-015-B, which can measure high frequency only.

At the peak of 220Vac input voltage and ~25W external load, the instantaneous value of input voltage is 312V, peak input current is ~300mA (location B), duty cycle is about 14.2%

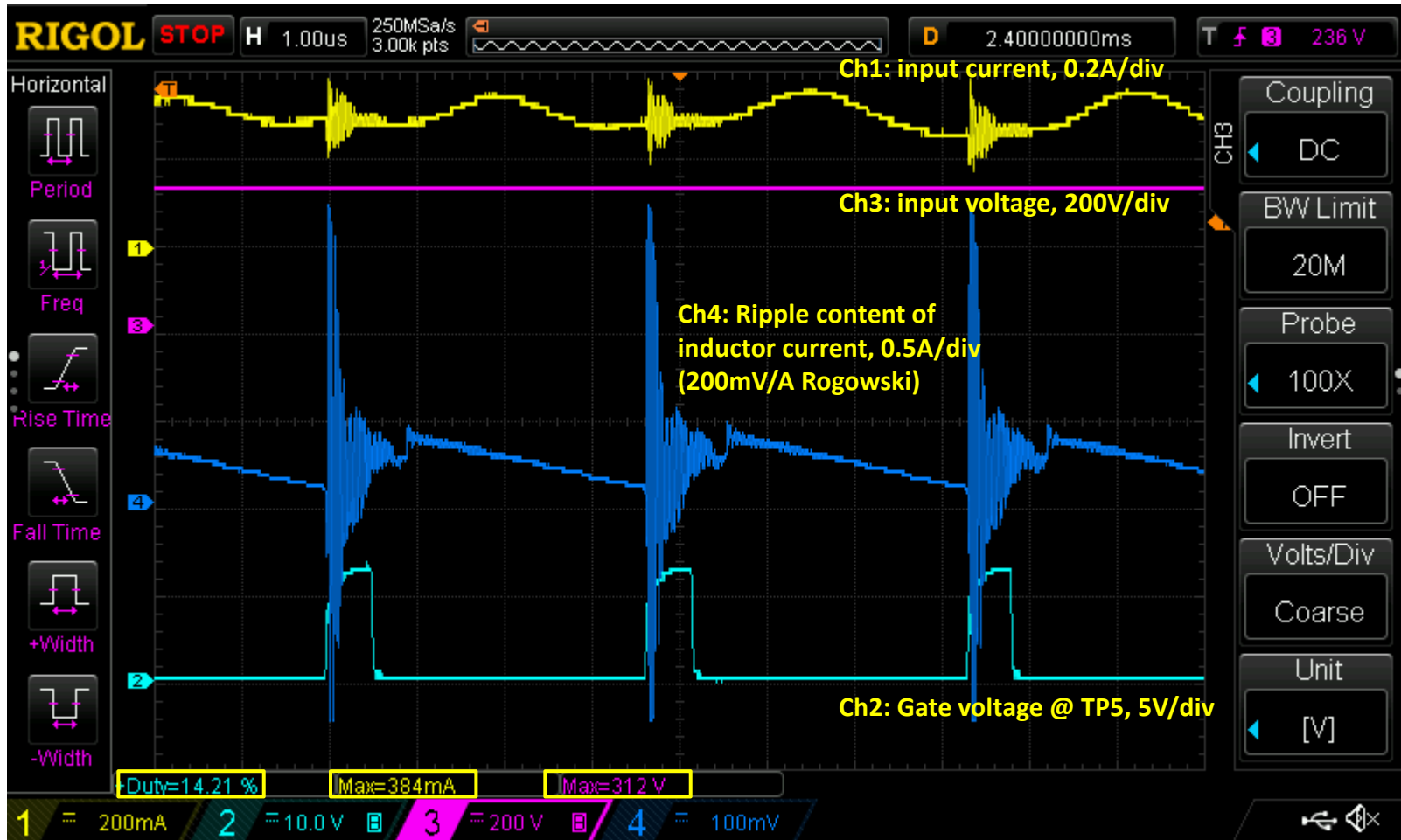

Measuring inductor current vs gate voltages, 12/25

Ch1: Fluke 80i-110S, which has limited bandwidth

Ch4: Tek TCPA300 w/ TCP312 Current probe

At 85Vac input voltage and ~25W external load, no major distortions observed

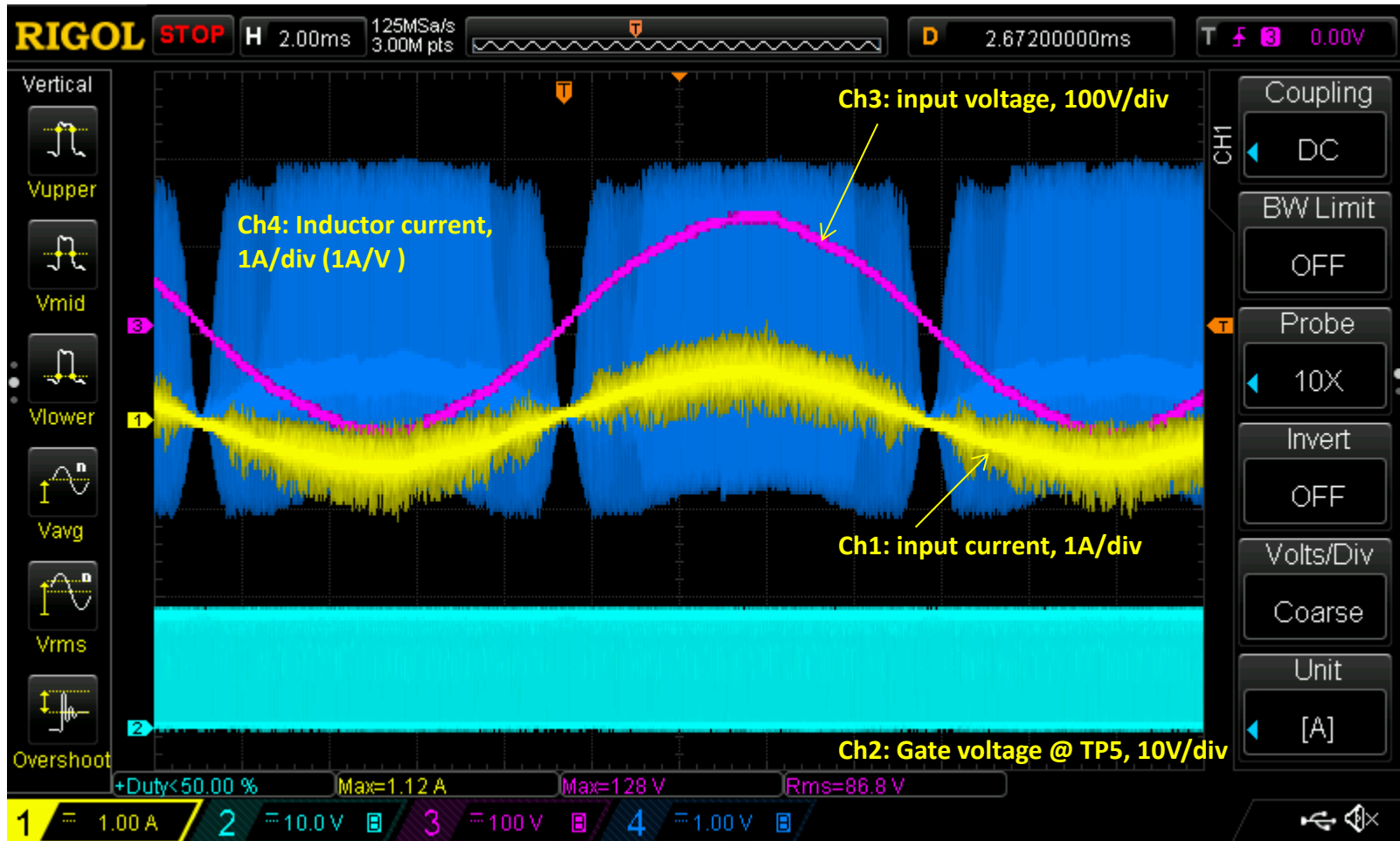

Measuring inductor current vs gate voltages, 12/25

Ch1: Fluke 80i-110S, which has limited bandwidth

Ch4: Tek TCPA300 w/ TCP312 Current probe

At 85Vac input voltage and ~25W external load, no major distortions observed

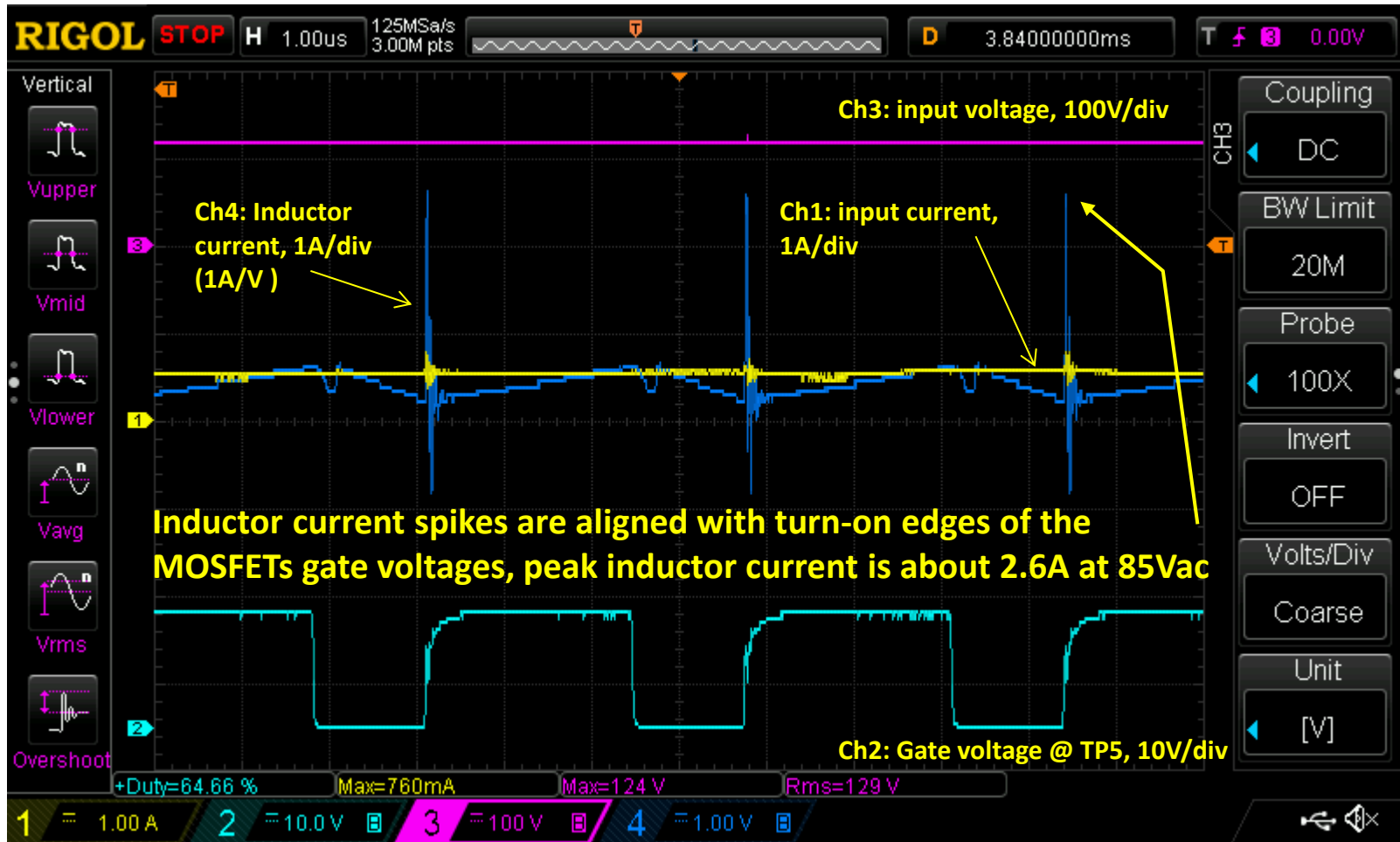

Measuring inductor current vs gate voltages, 12/25

Ch1: Fluke 80i-110S, which has limited bandwidth

Ch4: Tek TCPA300 w/ TCP312 Current probe

At ~230Vac input voltage and ~25W external load, distortions observed. See next slides for location A, B details

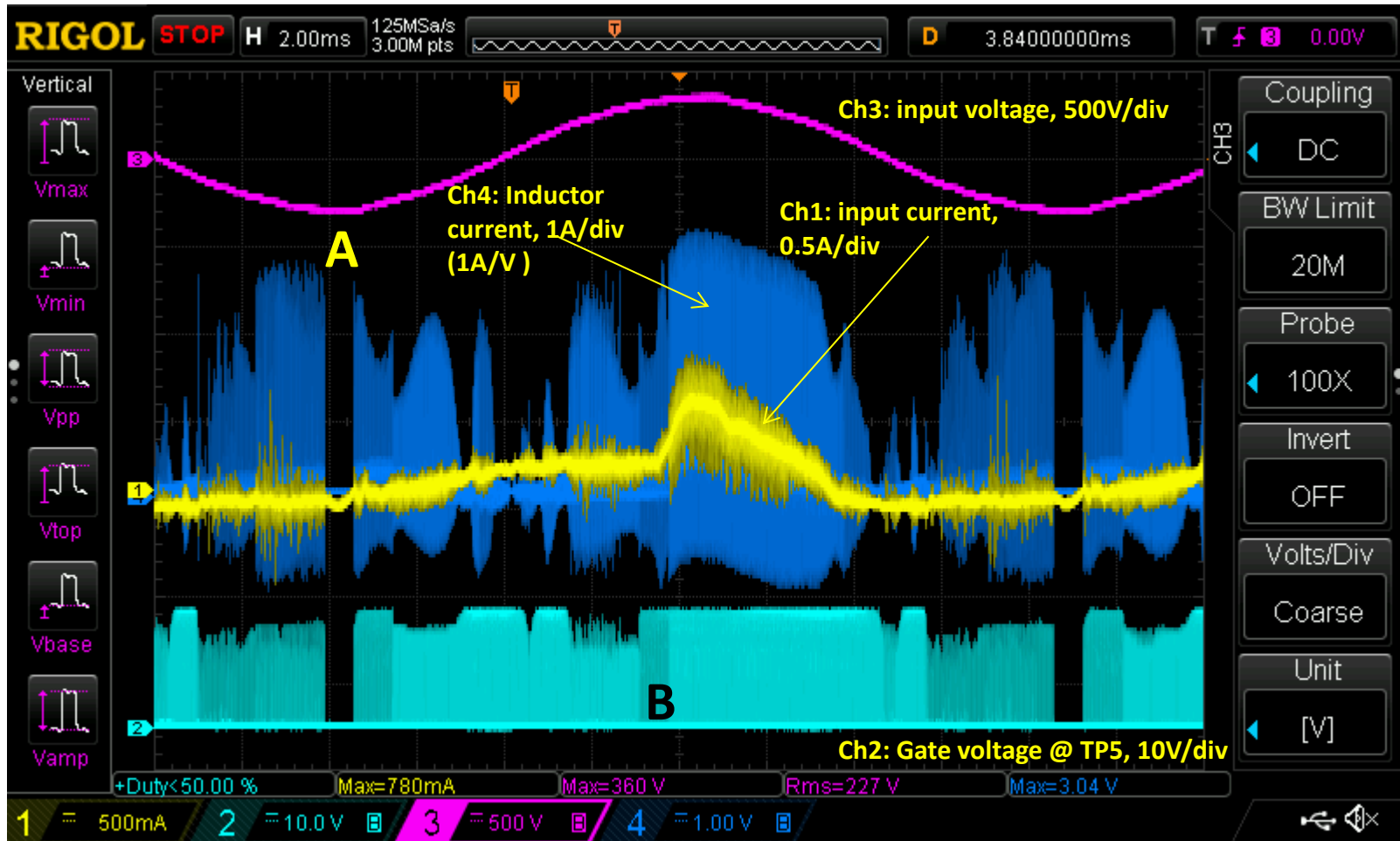

Measuring inductor current vs gate voltages, 12/25

Ch1: Fluke 80i-110S, which has limited bandwidth

Ch4: Tek TCPA300 w/ TCP312 Current probe

At ~230Vac input voltage and ~25W external load, distortions observed.

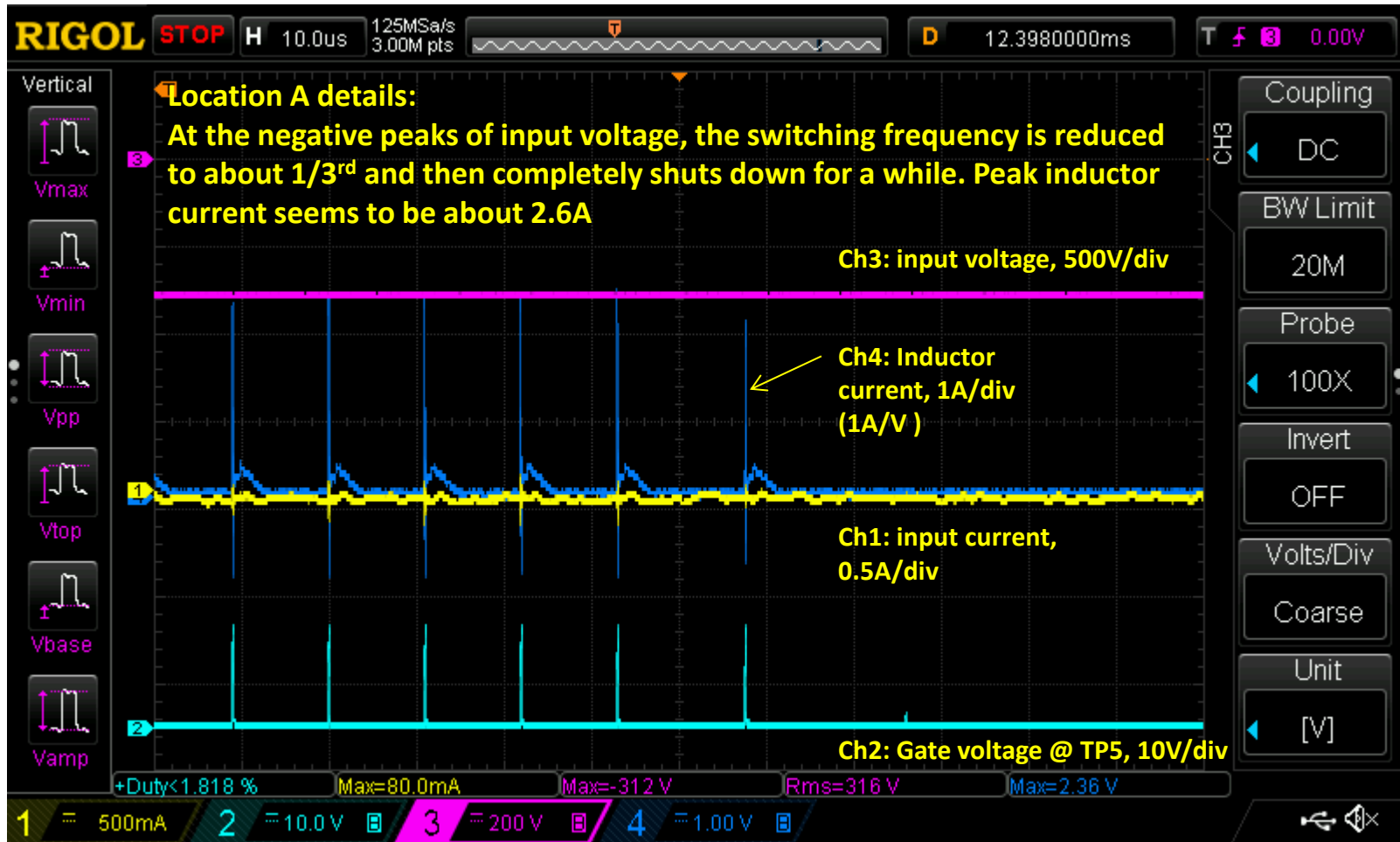

Measuring inductor current vs gate voltages, 12/25

Ch1: Fluke 80i-110S, which has limited bandwidth

Ch4: Tek TCPA300 w/ TCP312 Current probe

At ~230Vac input voltage and ~25W external load, distortions observed.

Location B details:

At the positive peaks of input voltage, the switching frequency is reduced to about ½ and this results in “flat top” on the current waveform. After that the switching frequency is raised and around that time the current surge is observed

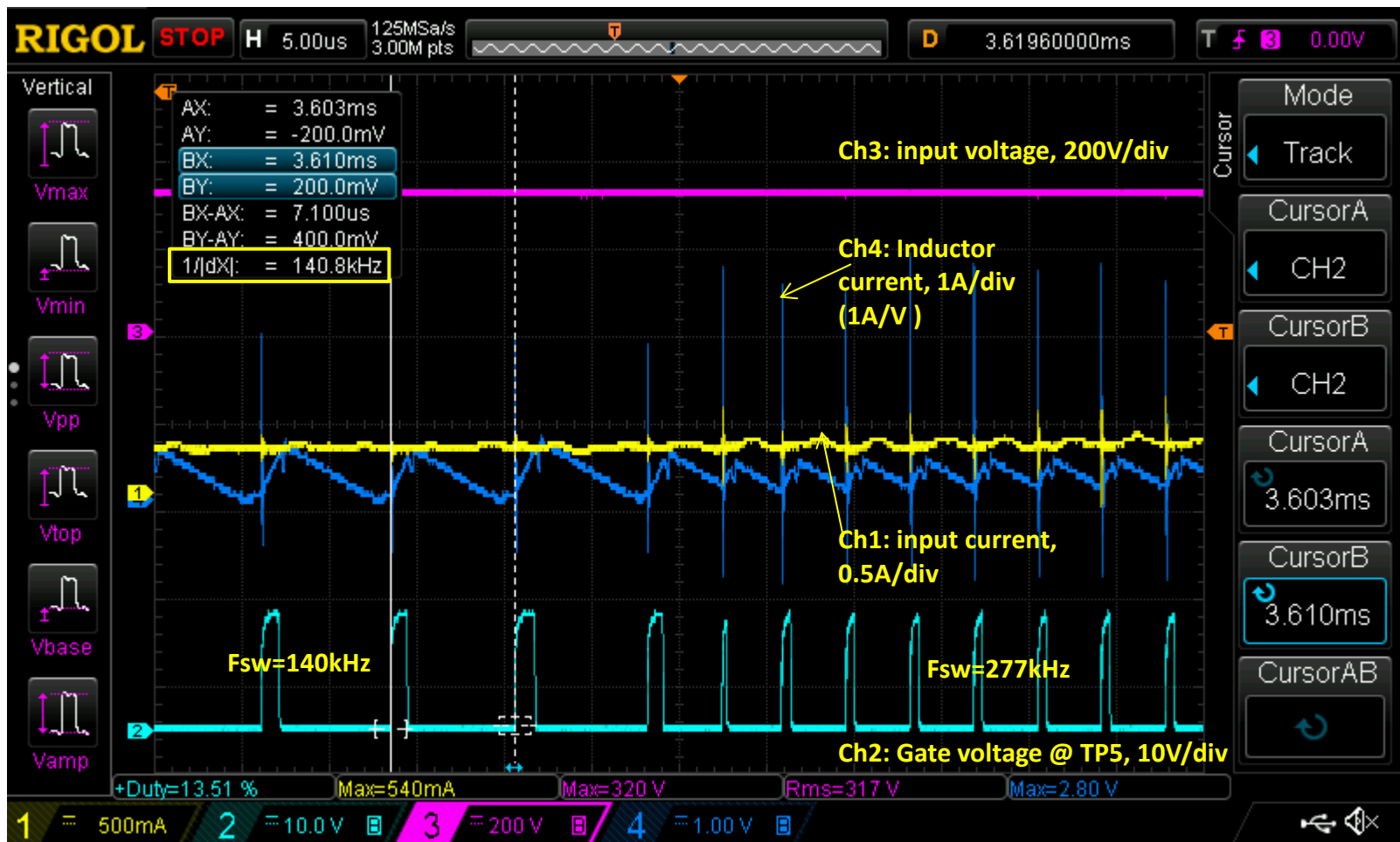

Measuring inductor current vs gate voltages, 12/25

Ch1: Fluke 80i-110S, which has limited bandwidth

Ch4: Tek TCPA300 w/ TCP312 Current probe

At ~230Vac input voltage and ~25W external load, distortions observed.

Location B details:

At the positive peaks of input voltage, the switching frequency is reduced to about $\frac{1}{2}$ and this results in “flat top” on the current waveform. After that the switching frequency is raised and around that time the current surge is observed



Measuring inductor current vs gate voltages, 12/25

Ch1: Fluke 80i-110S, which has limited bandwidth

Ch4: Tek TCPA300 w/ TCP312 Current probe

At ~230Vac input voltage and ~25W external load, distortions observed.

At 230Vac input, 25W external load, the view of locations A (negative peak) and location B (positive peak)

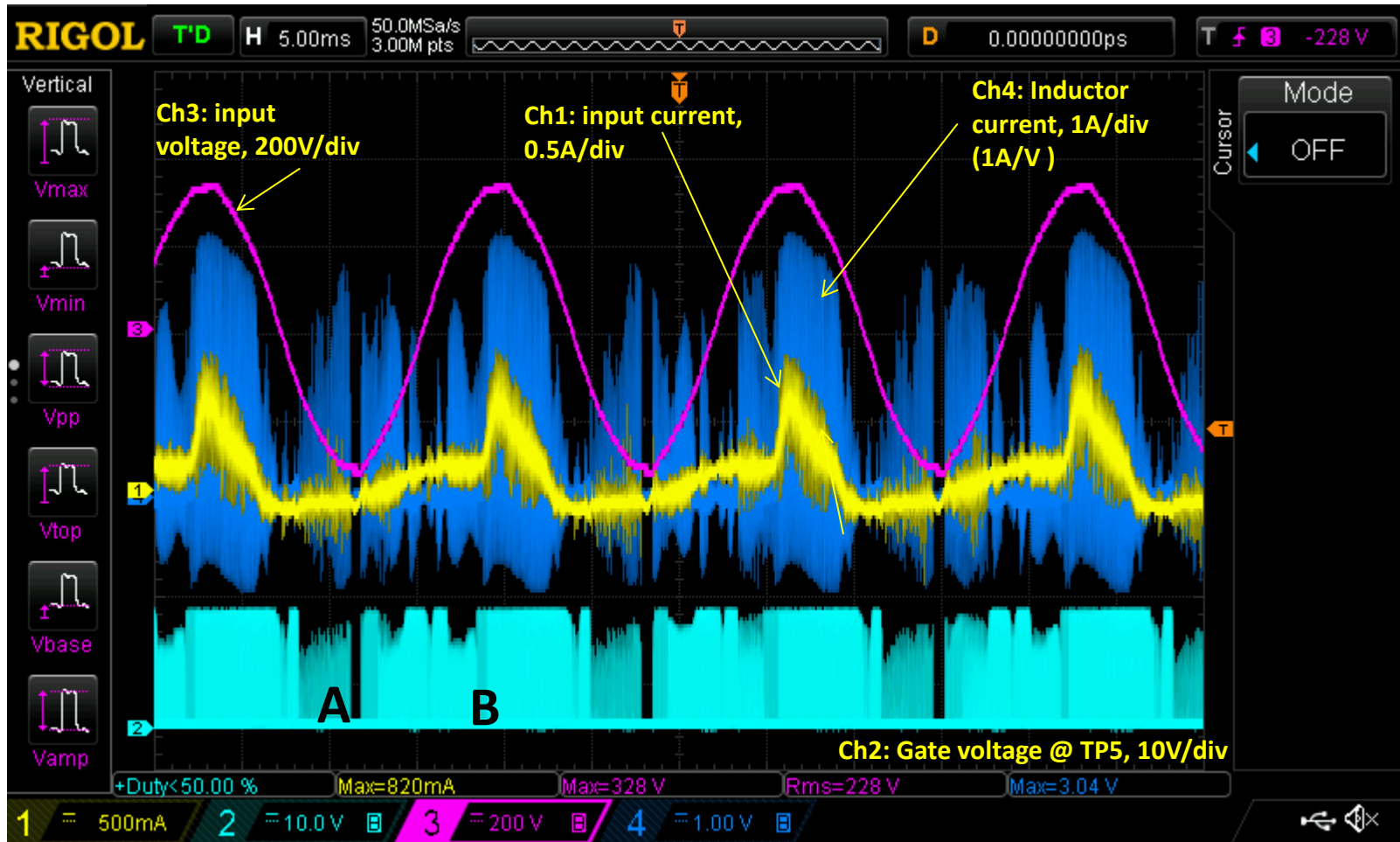

Measuring inductor current vs gate voltages, 12/25

Ch1: Fluke 80i-110S, which has limited bandwidth

Ch4: Tek TCPA300 w/ TCP312 Current probe

At ~230Vac input voltage and ~25W external load, distortions observed.

Location A: Current probe on Ch1 has low BW and is used to measure input current only.

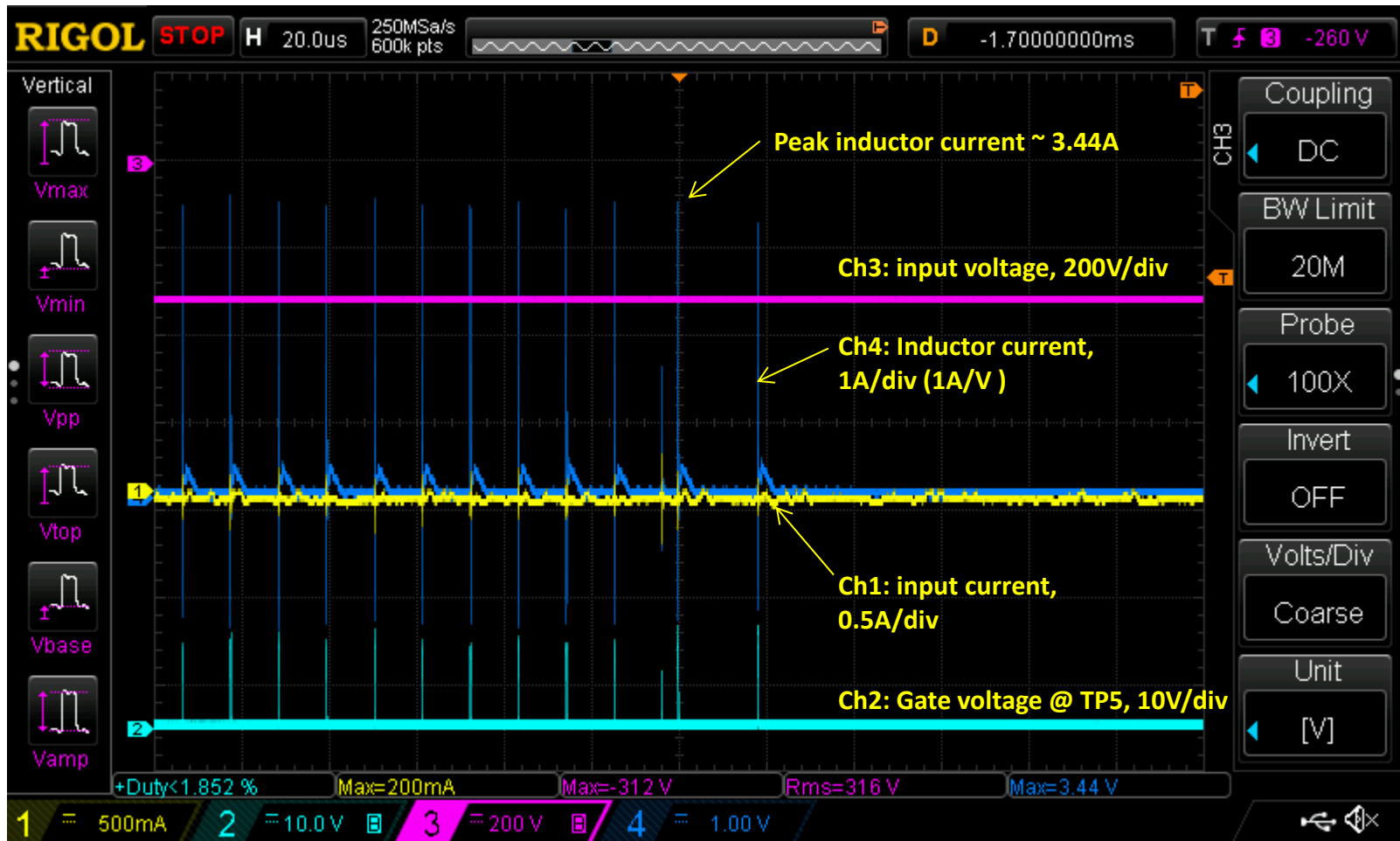

Measuring inductor current vs gate voltages, 12/25

Ch1: Fluke 80i-110S, which has limited bandwidth

Ch4: Tek TCPA300 w/ TCP312 Current probe

At ~230Vac input voltage and ~25W external load, distortions observed.

There is a 68nF cap after the rectifier. It is increased to $2 \times 68 = 136\text{nF}$, did not observe any improvements

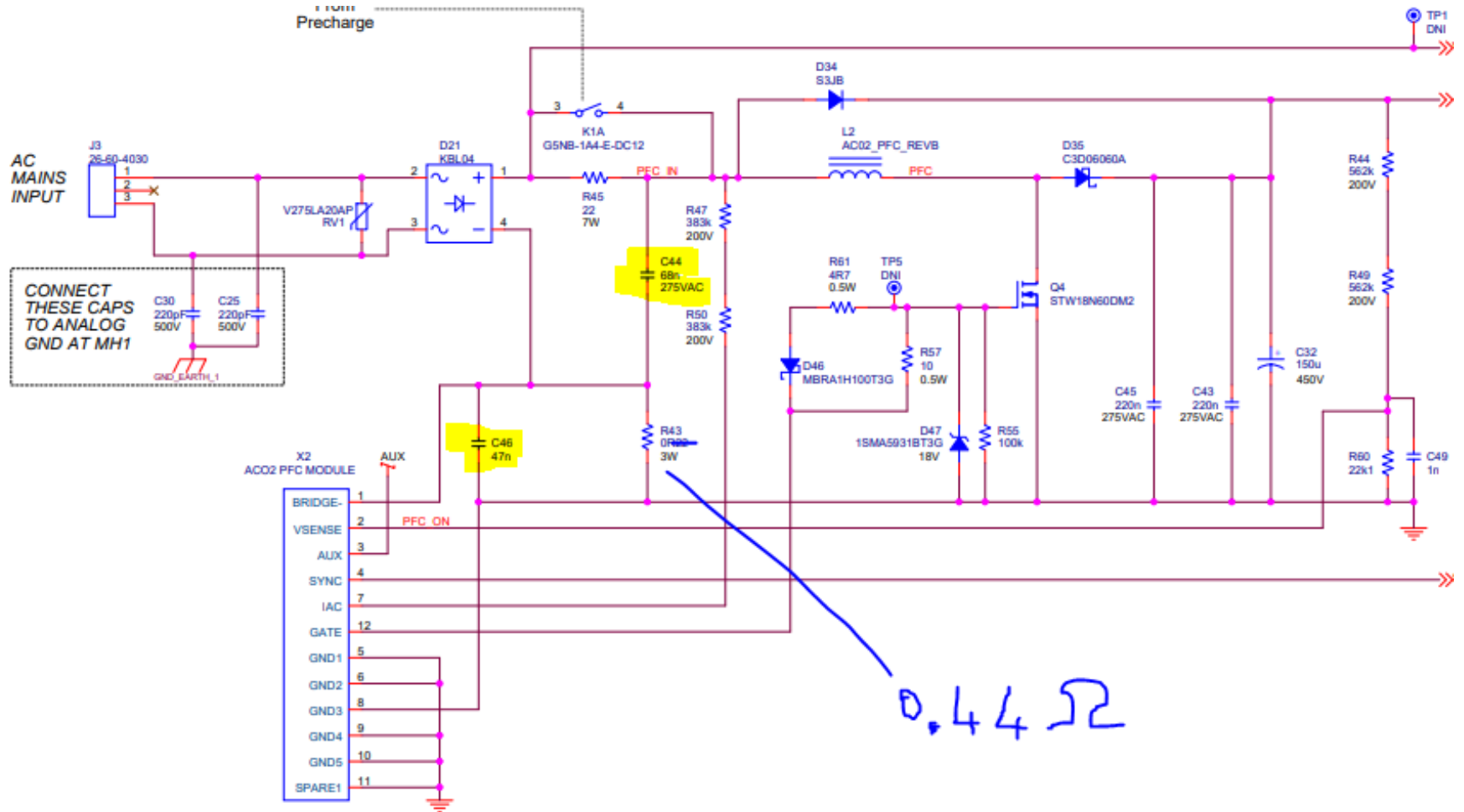

Measuring inductor current vs gate voltages, 12/25

Ch1: Fluke 80i-110S, which has limited bandwidth

Ch4: Tek TCPA300 w/ TCP312 Current probe

At $\sim 230\text{Vac}$ input voltage and $\sim 25\text{W}$ external load, distortions observed.

There is a 68nF cap after the rectifier. It is increased to $2 \times 68 = 136\text{nF}$, did not observe any improvements

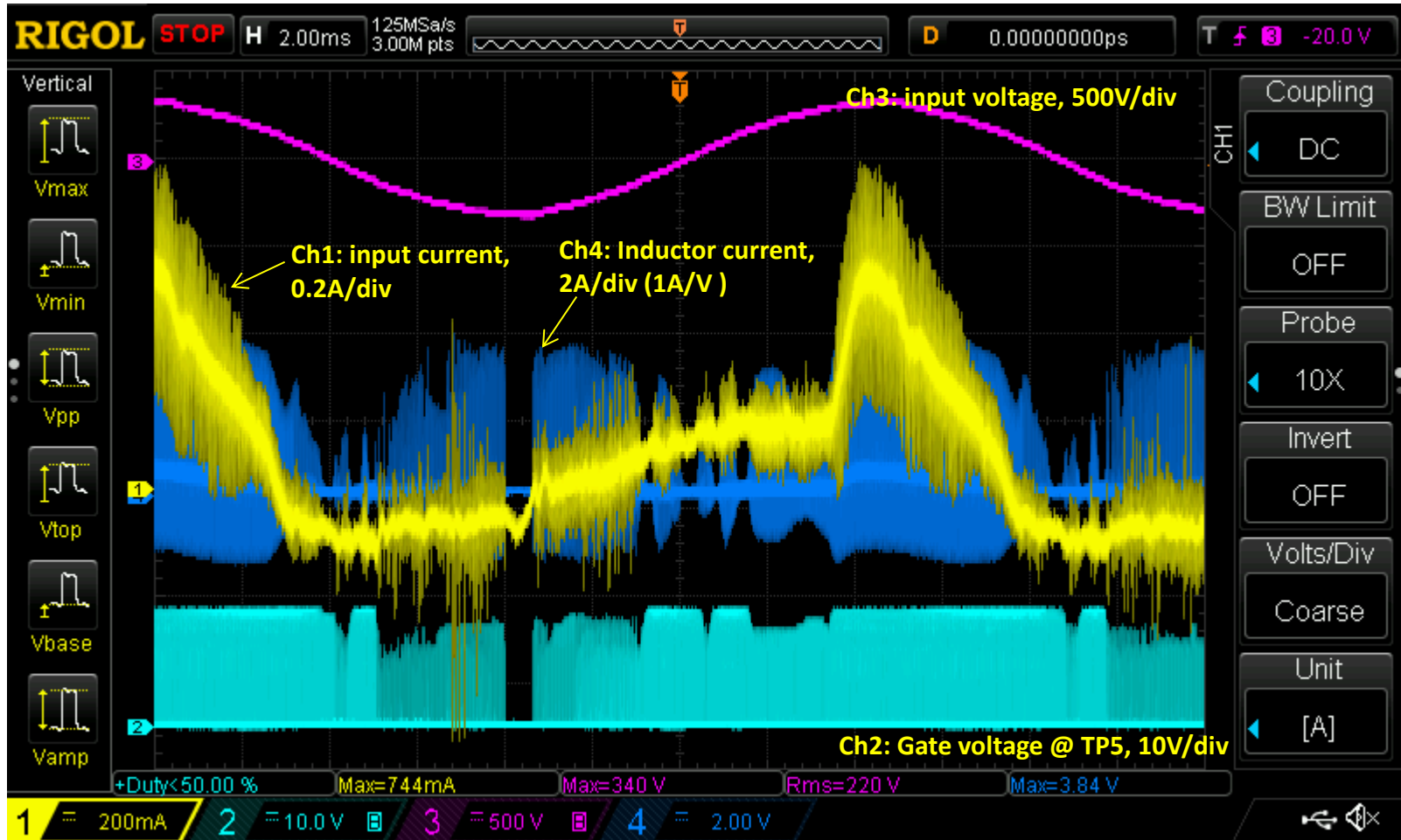

Measuring inductor current vs gate voltages, 12/25

Ch1: Fluke 80i-110S, which has limited bandwidth

Ch4: Tek TCPA300 w/ TCP312 Current probe

At ~230Vac input voltage and ~25W external load, distortions observed.

Added 100pF across the R5 (R7 on data sheet), did not observe any improvements

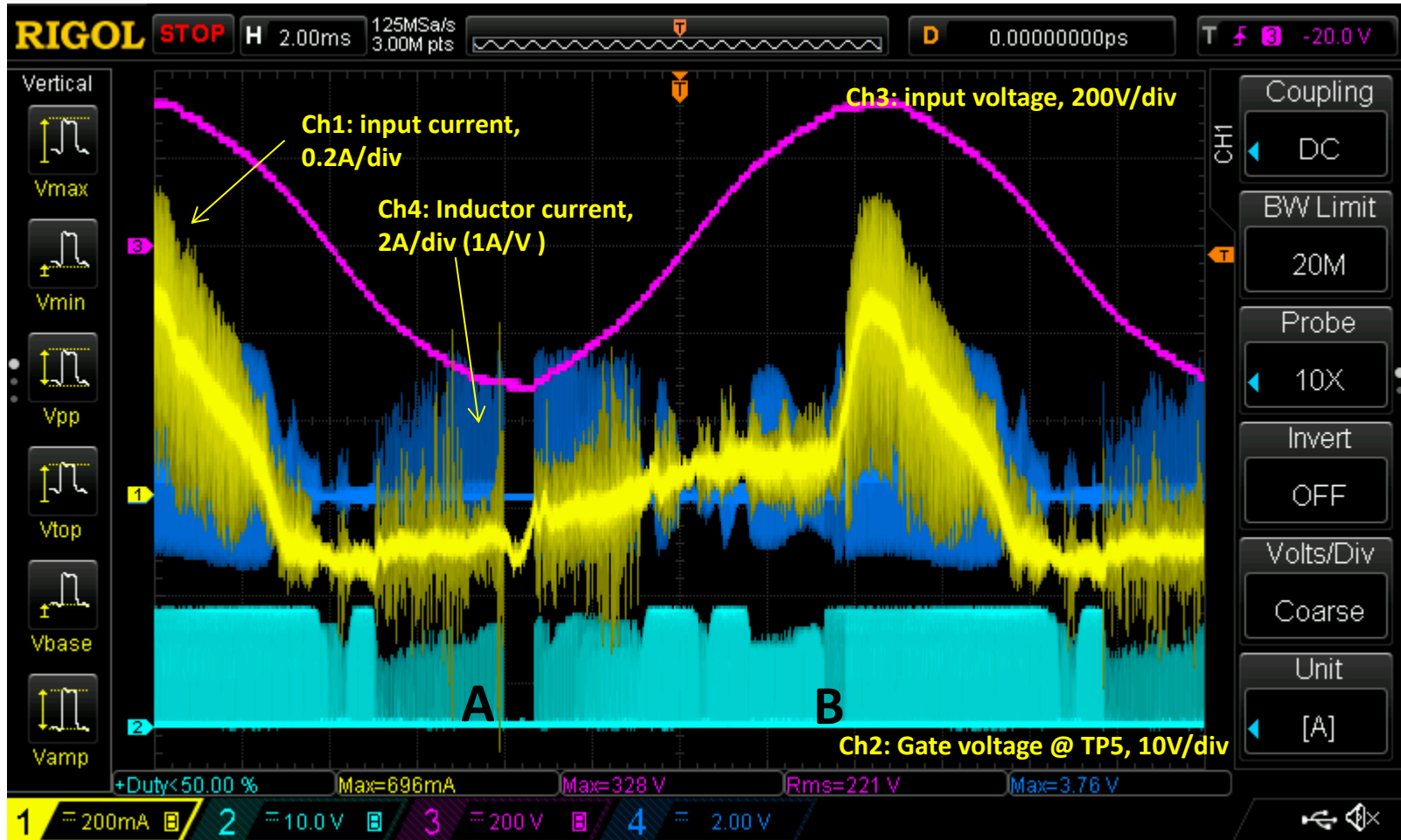

Measuring inductor current vs gate voltages, 12/25

Ch1: Fluke 80i-110S, which has limited bandwidth

Ch4: Tek TCPA300 w/ TCP312 Current probe

At ~230Vac input voltage and ~25W external load, distortions observed.

Added 100pF across the R5 (R7 on data sheet), did not observe any improvements

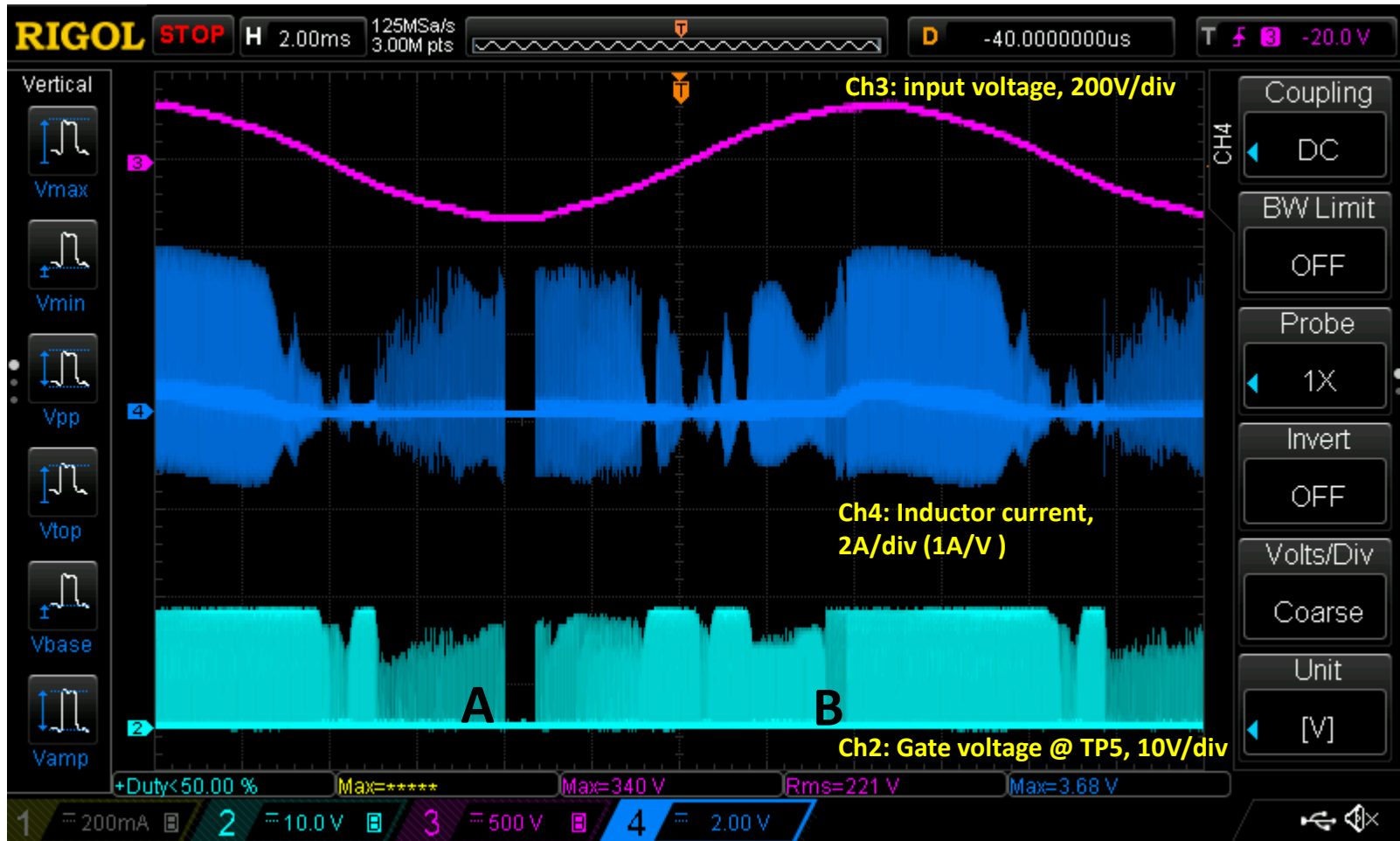

Measuring inductor current vs gate voltages, 12/25

Ch1: Fluke 80i-110S, which has limited bandwidth

Ch4: Tek TCPA300 w/ TCP312 Current probe

At ~230Vac input voltage and ~25W external load, distortions observed.

Added 100pF across the R5 (R7 on data sheet), did not observe any improvements

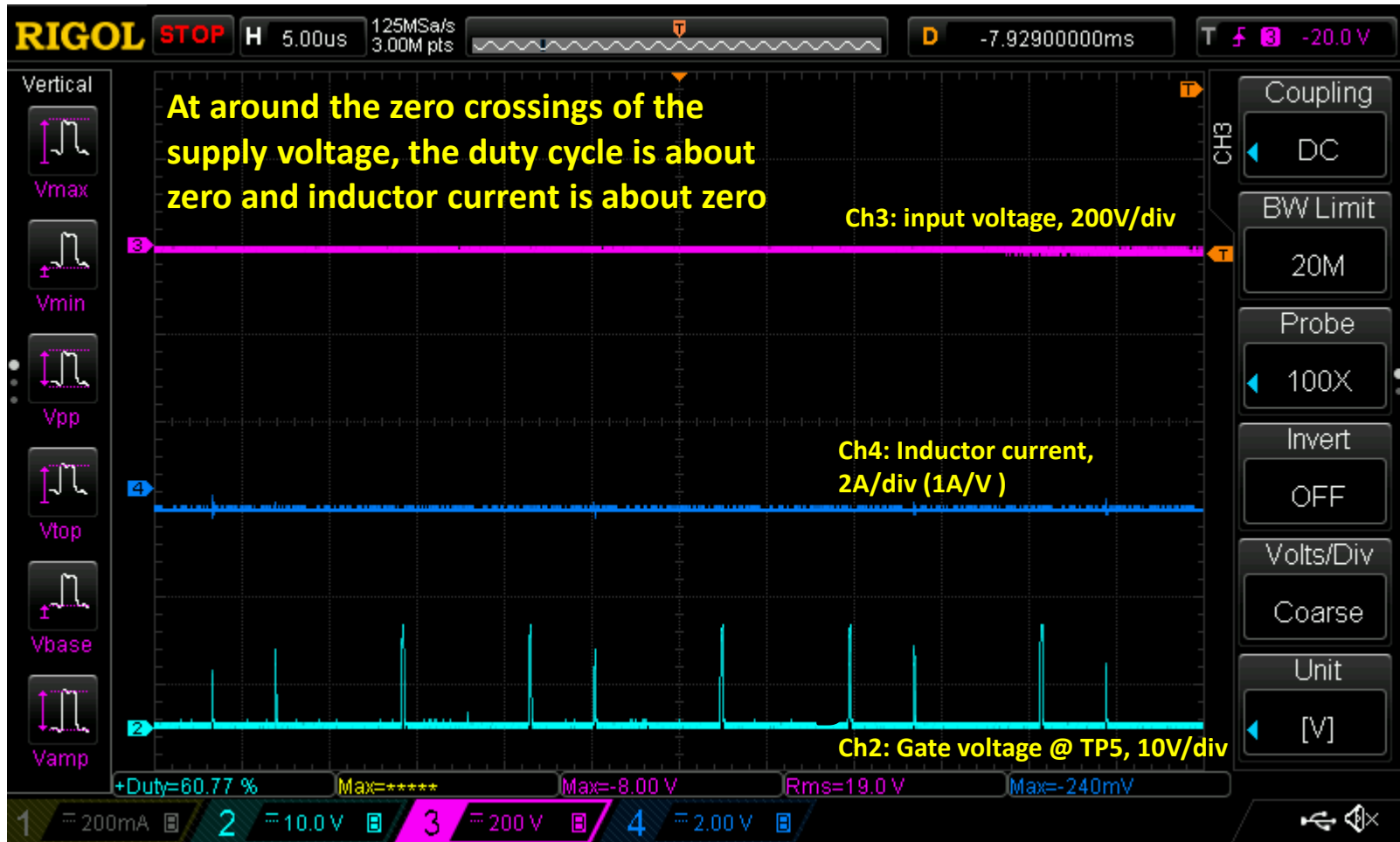

Measuring inductor current vs gate voltages, 12/25

Ch1: Fluke 80i-110S, which has limited bandwidth

Ch4: Tek TCPA300 w/ TCP312 Current probe

At ~230Vac input voltage and ~25W external load, distortions observed.

Added 100pF across the R5 (R7 on data sheet), did not observe any improvements

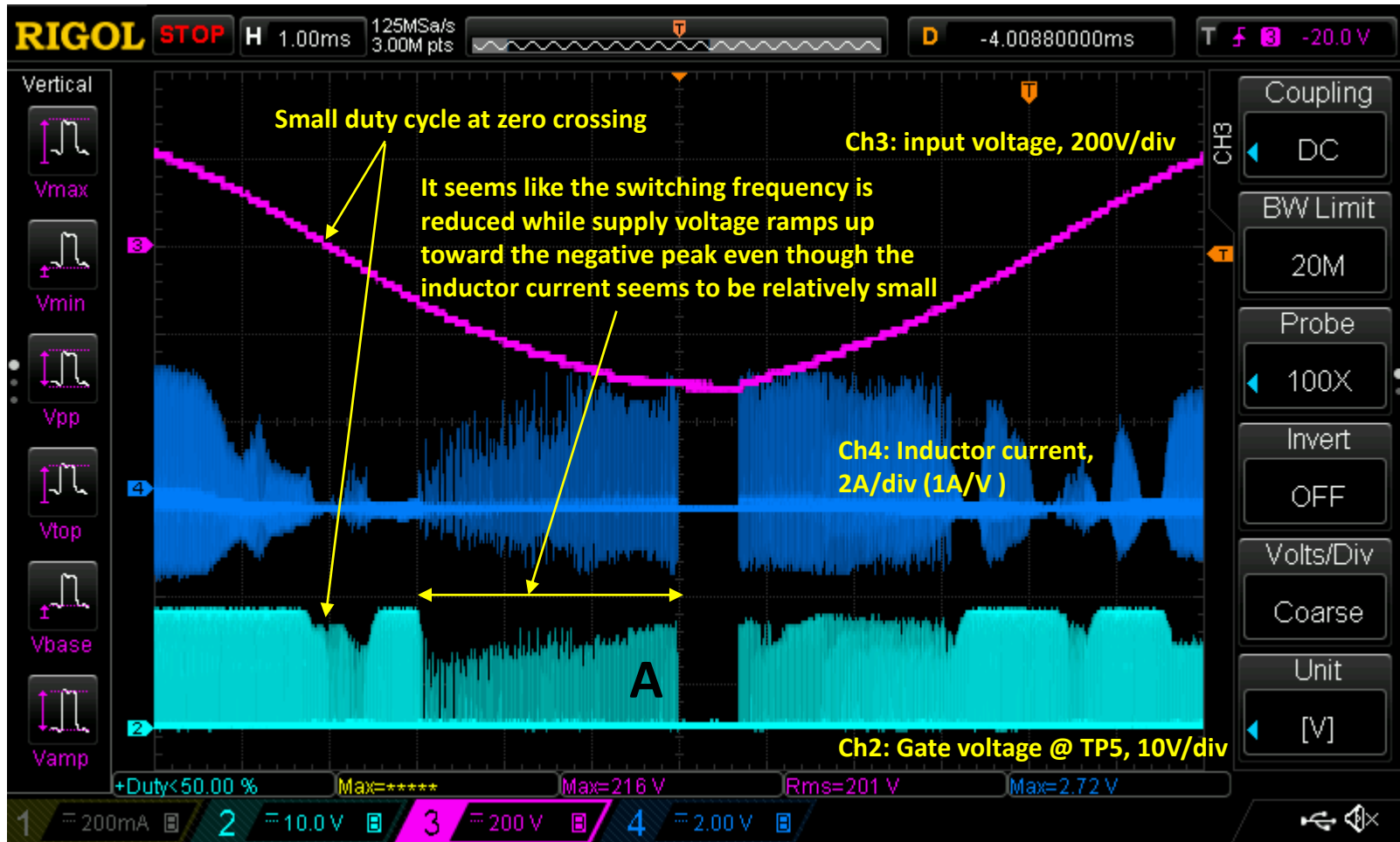

Measuring inductor current vs gate voltages, 12/25

Ch1: Fluke 80i-110S, which has limited bandwidth

Ch4: Tek TCPA300 w/ TCP312 Current probe

At ~230Vac input voltage and ~25W external load, distortions observed.

Added 100pF across the R5 (R7 on data sheet), did not observe any improvements

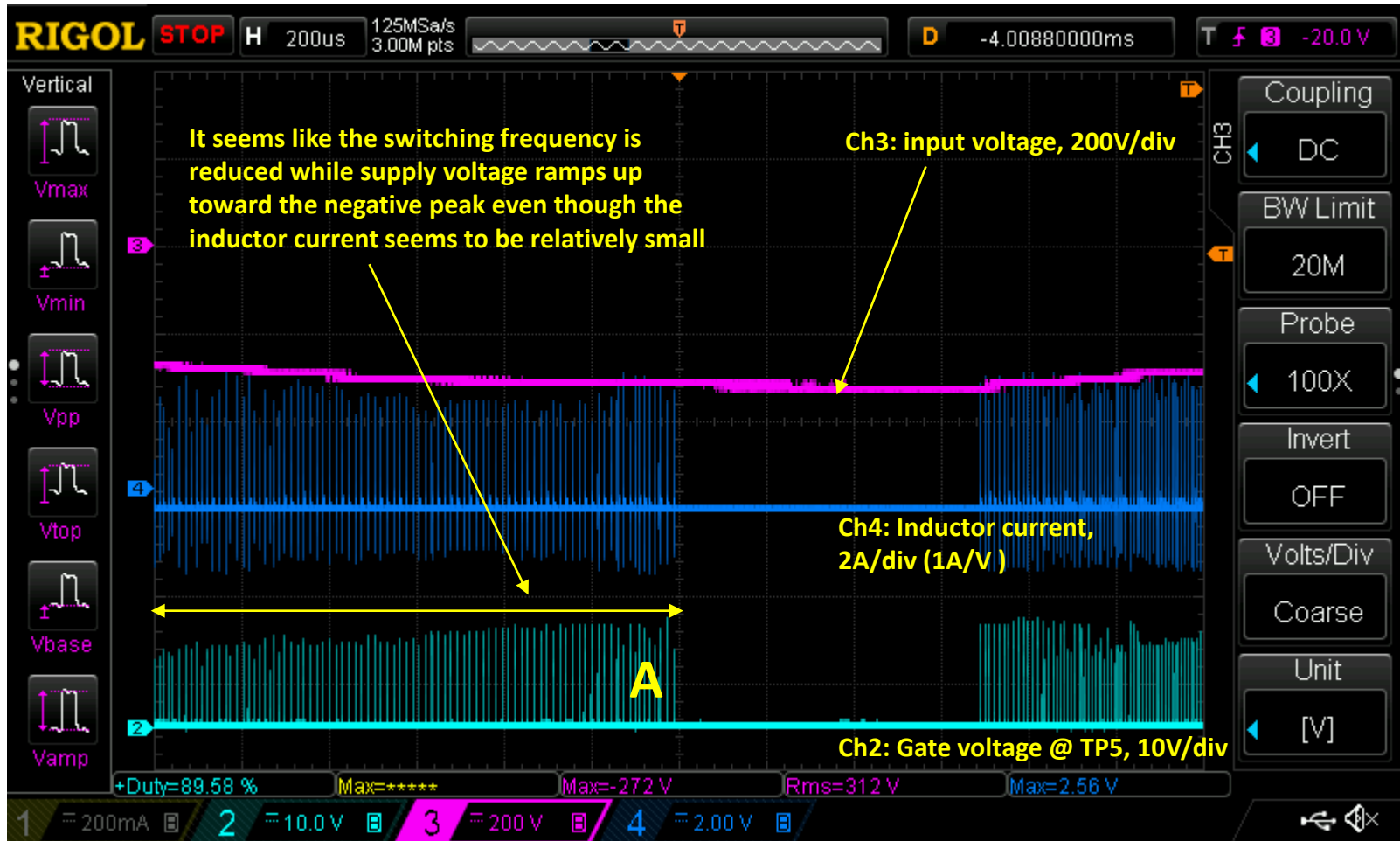

Measuring inductor current vs gate voltages, 12/25

Ch1: Fluke 80i-110S, which has limited bandwidth

Ch4: Tek TCPA300 w/ TCP312 Current probe

At ~230Vac input voltage and ~25W external load, distortions observed.

Added 100pF across the R5 (R7 on data sheet), did not observe any improvements

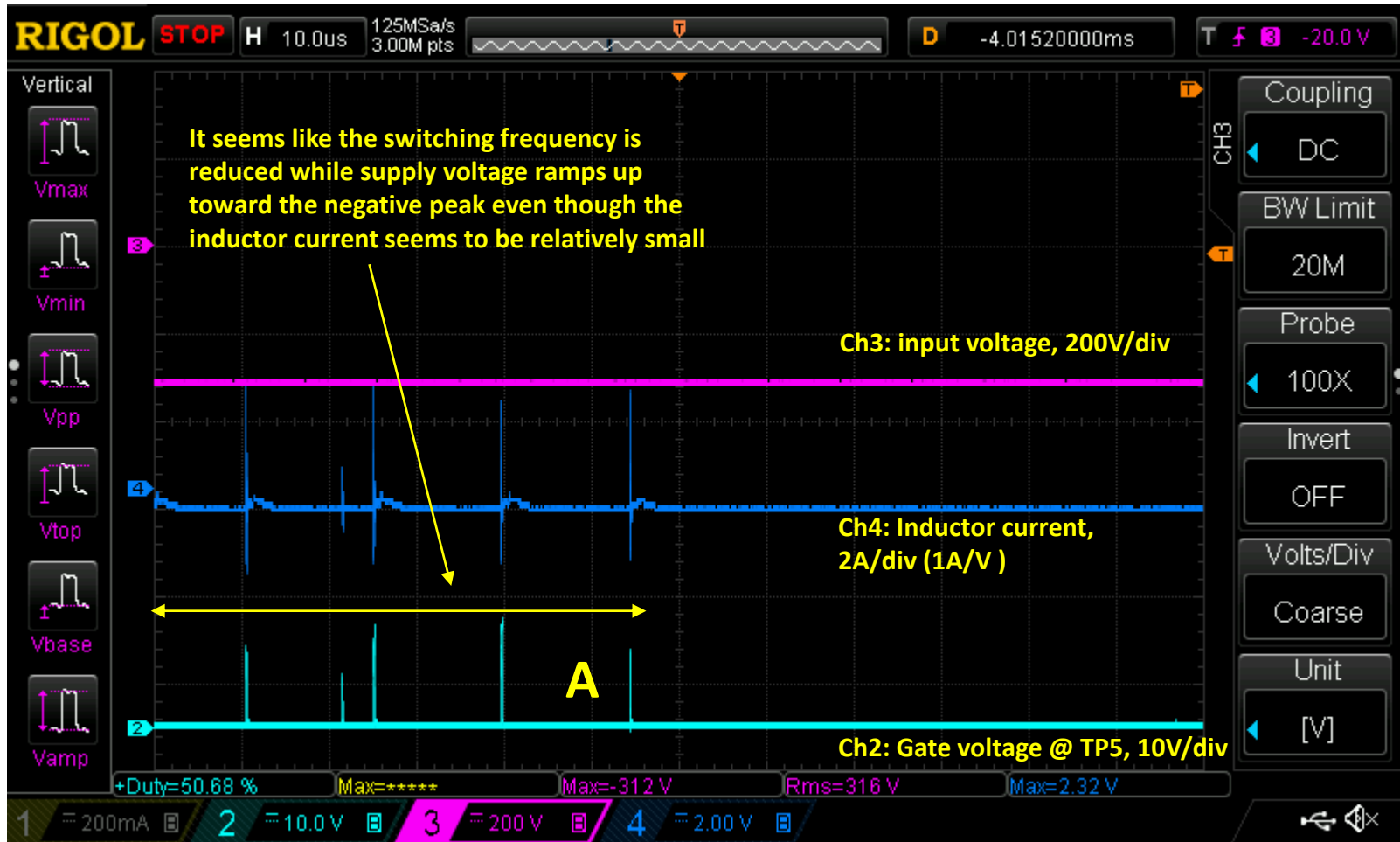

Measuring inductor current vs gate voltages, 12/25

Ch1: Fluke 80i-110S, which has limited bandwidth

Ch4: Tek TCPA300 w/ TCP312 Current probe

At ~230Vac input voltage and ~25W external load, distortions observed.

Observations:

- 1) Location A: While the supply voltage ramps up toward the negative peak, the switching frequency is reduced significantly and then MOSFET shuts down for a while at the negative peak. It seems like the inductor current is relatively small and this may not be current limit initiated turn off.
- 2) Location B: While the supply voltage ramps up toward the positive peak, the switching frequency is reduced by about 50%. It is observed this corresponds to “flat top” on supply current. At around the peak of supply voltage, the switching frequency suddenly snaps back to normal frequency and this corresponds to surge in peak of the supply voltage. It is not clear if this phenomenon is caused by activation of current limit.
- 3) Adding an other 68nF cap after rectifier did not improve the issue
- 4) Adding 100nF cap across R5 (R7 on data sheet) did not improve the issue

Measuring inductor current vs gate voltages, 12/25

PCB	RefDes on datasheet	RefDes in design	12/11/2022 Fci=44kHz, Gci=5.6	12/25/2022 Fci=11kHz, Gci=1.6
PSB-04	R1	R47, R50	383K	383K
	R2	R43	0.44	0.44
	L1	L2	660uH	660uH
PFC-03	R8, R12	R4, R9	2.74K	2.74K
	R13	R10	15.8K	4.7K
	C6	C6	233pF (200p//33p)	3.3n
	C7	C8	33pF	150pF
	R15	R11	30.1K	30.1K
	C8	C9	4.7uF	4.7uF
	C10	C1	1.5uF	1.5uF
	C11	C2	150nF	150nF
	R21	R1	48.7K	48.7K
	R14	R13	10K	10K
	R7	R5	1.50K (3.3K//2.74K) +100pF	1.50K (3.3K//2.74K) + 100pF
C9	C4	1uF	1uF	

Measuring inductor current vs gate voltages, 12/25

Ch1: Fluke 80i-110S, which has limited bandwidth

Ch4: Tek TCPA300 w/ TCP312 Current probe

Per changes listed on page 55

At ~85Vac input voltage and ~25W external load, no major distortions observed

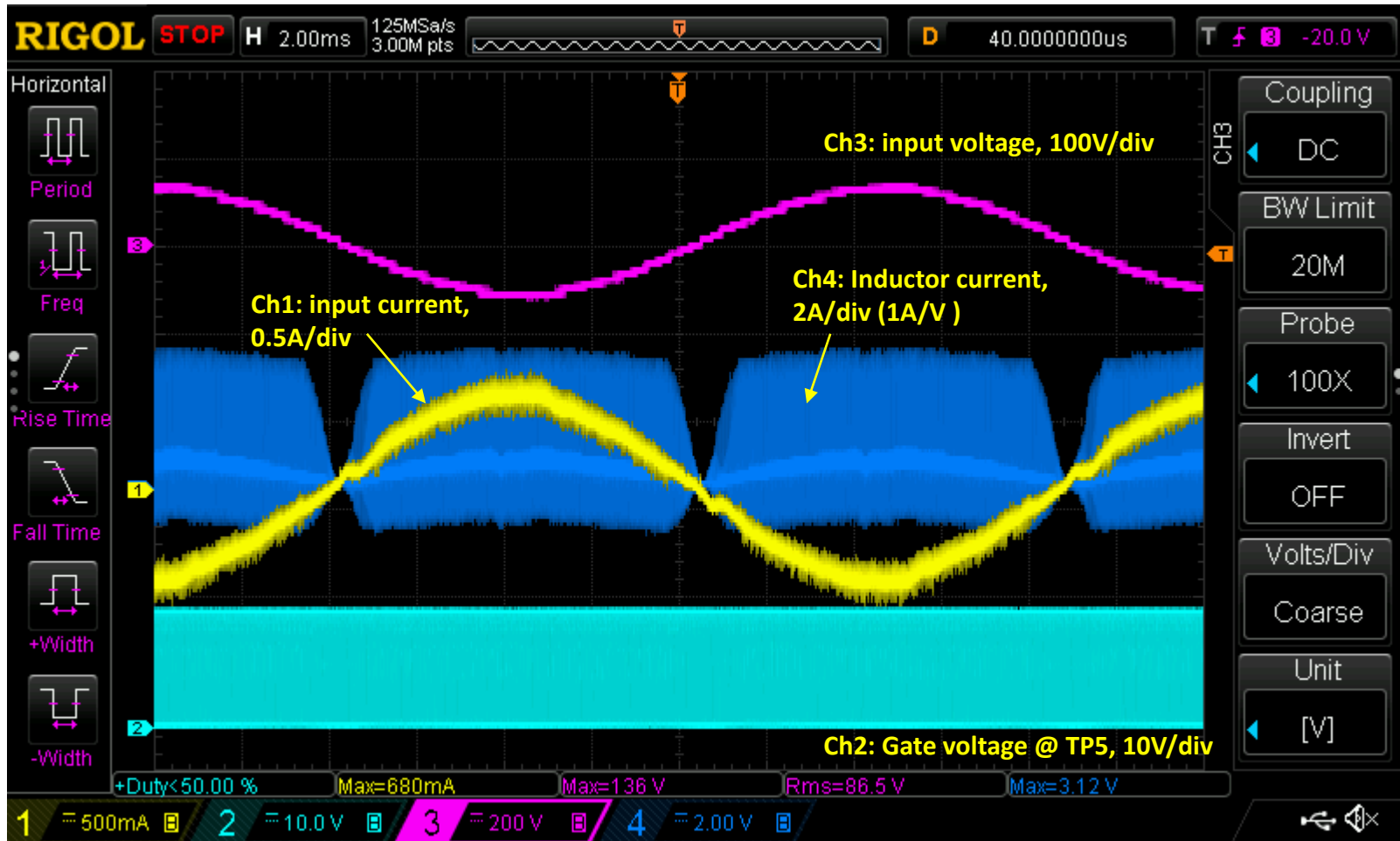

Measuring inductor current vs gate voltages, 12/25

Ch1: Fluke 80i-110S, which has limited bandwidth

Ch4: Tek TCPA300 w/ TCP312 Current probe

Per changes listed on page 55

At ~230Vac input voltage and ~25W external load, major distortions observed

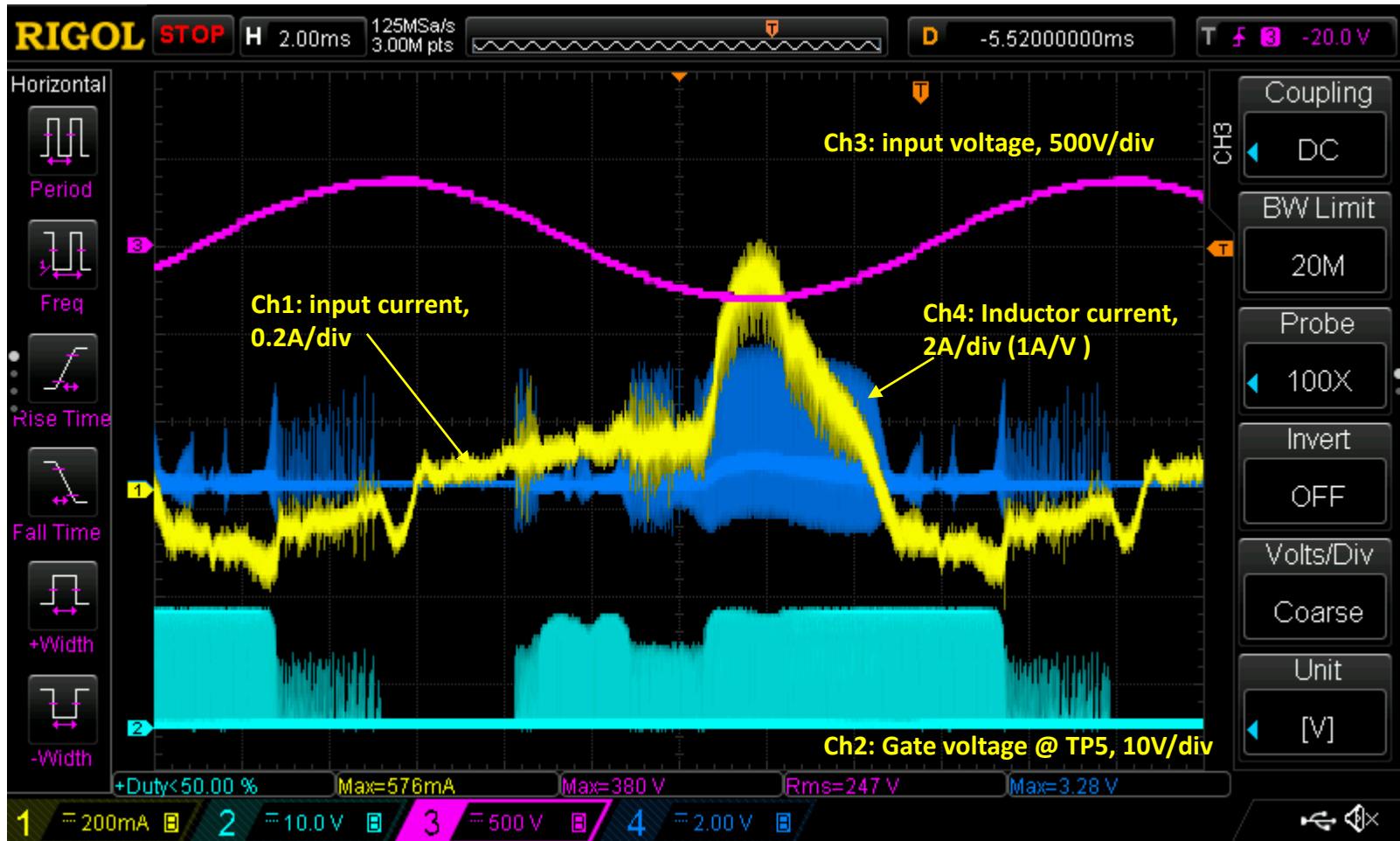

Measuring inductor current vs gate voltages, 12/28

Ch1: Fluke 80i-110S, which has limited bandwidth

Ch4: Tek TCPA300 w/ TCP312 Current probe

Per changes listed on page 55

At ~230Vac input voltage and ~25W external load, major distortions observed

Investigating the effect of C46 on input current distortions

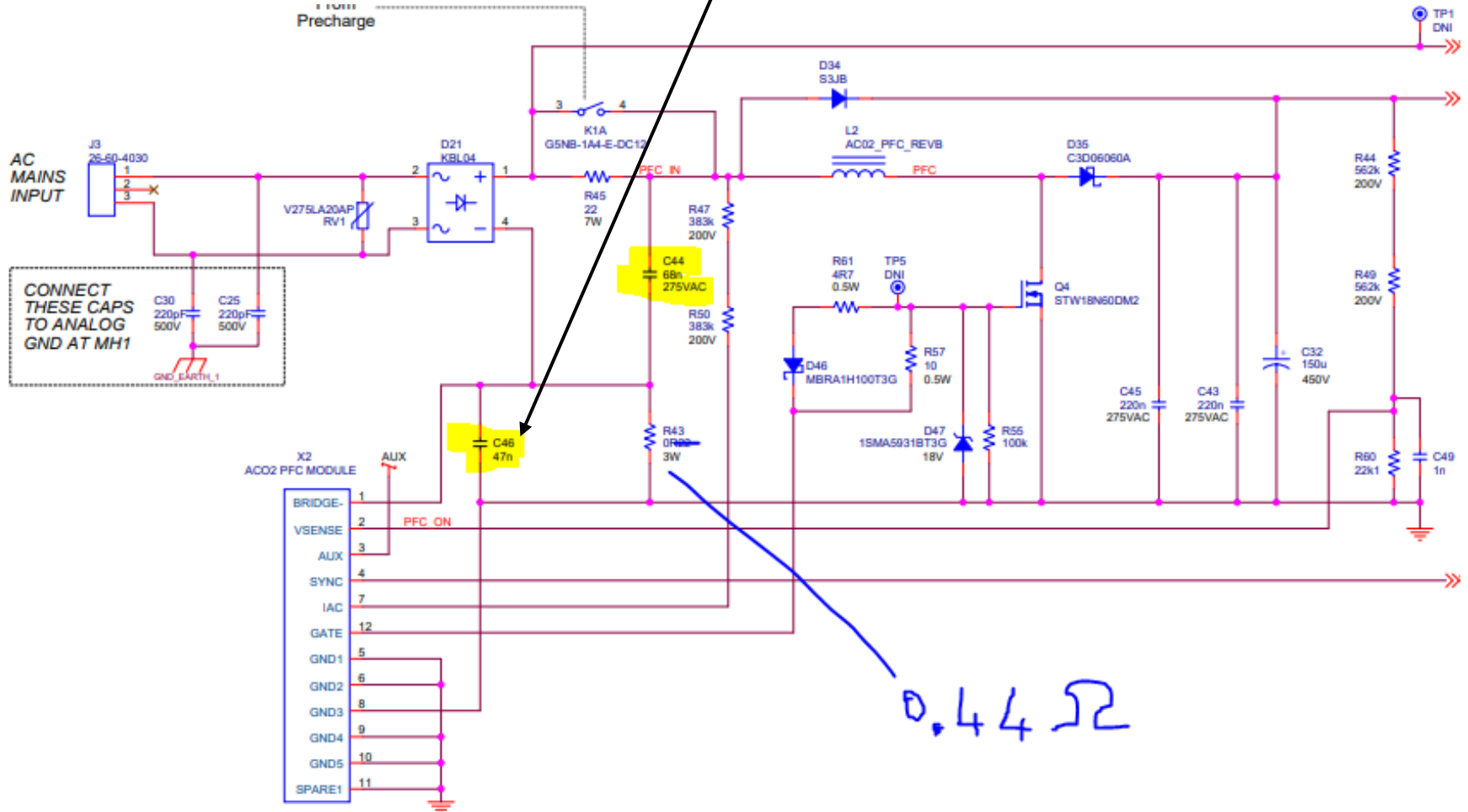

Measuring inductor current vs gate voltages, 12/28

Ch1: Fluke 80i-110S, which has limited bandwidth

Ch4: Tek TCPA300 w/ TCP312 Current probe

Per changes listed on page 55

At 90Vac input voltage, no C46, no major distortions observed

Ch4: Tek TCPA300, Ch1: Fluke 80i-110S



Measuring inductor current vs gate voltages, 12/28

Ch1: Fluke 80i-110S, which has limited bandwidth

Ch4: Tek TCPA300 w/ TCP312 Current probe

Per changes listed on page 55

At $\sim 100\text{Vac}$ input voltage, no C46, distortions started, notice the current surge from location A to B

Ch4: Tek TCPA300, Ch1: Fluke 80i-110S

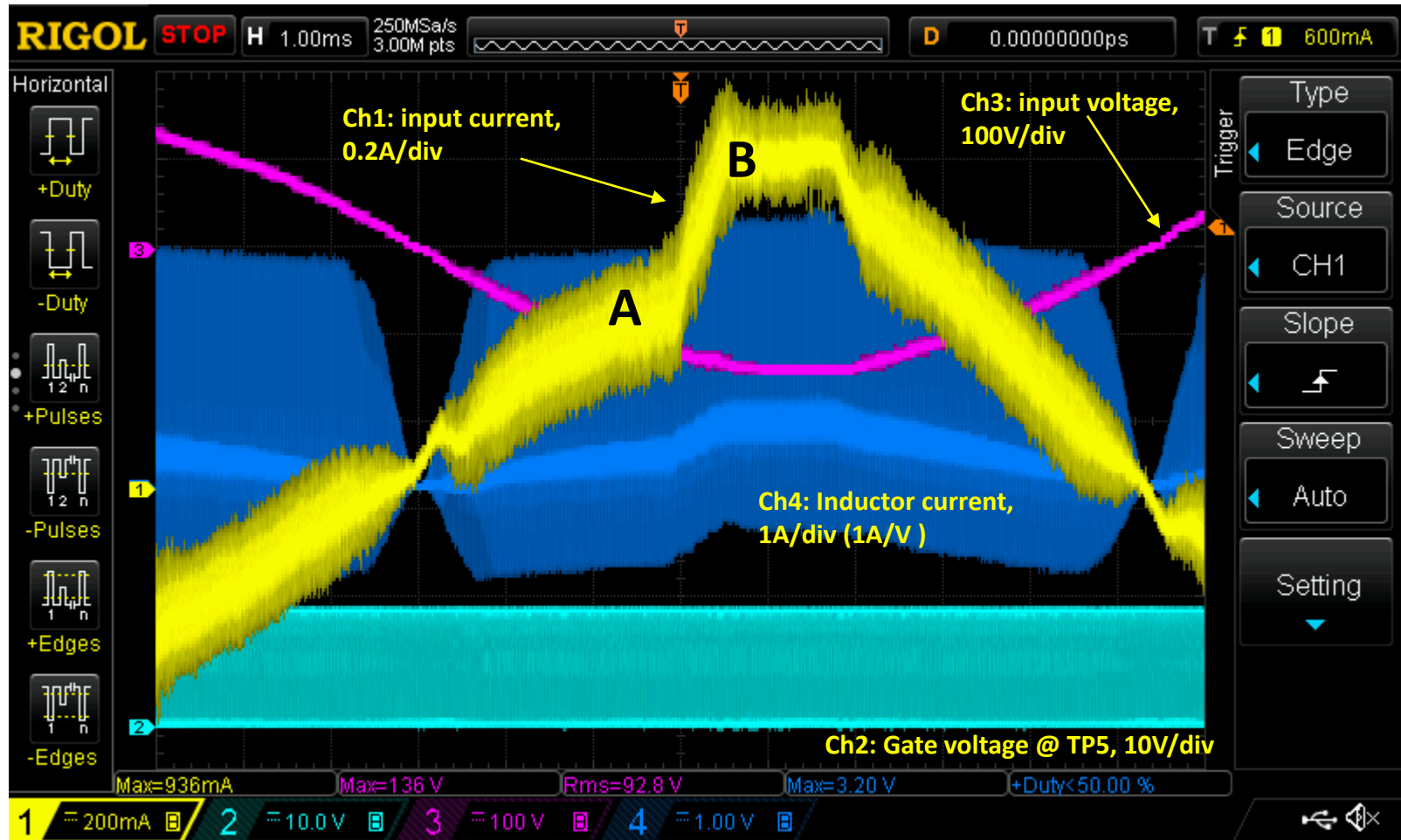

Measuring inductor current vs gate voltages, 12/28

Ch1: Fluke 80i-110S, which has limited bandwidth

Ch4: Tek TCPA300 w/ TCP312 Current probe

Per changes listed on page 55

At ~100Vac input voltage, no C46, distortions started

Ch4: Tek TCPA300, Ch1: Fluke 80i-110S

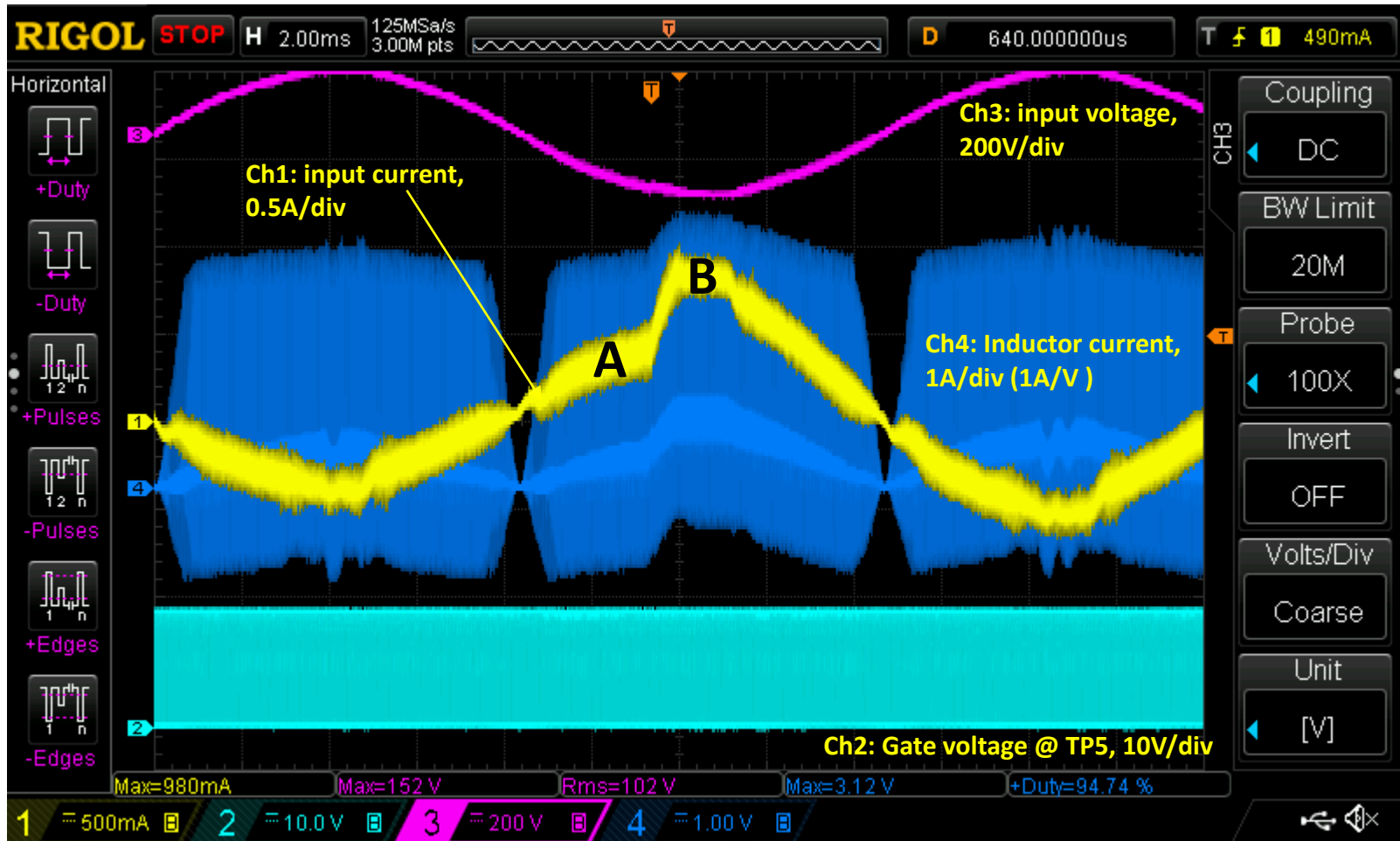

Measuring inductor current vs gate voltages, 12/28

Ch1: Fluke 80i-110S, which has limited bandwidth

Ch4: Tek TCPA300 w/ TCP312 Current probe

Per changes listed on page 55

At ~85Vac input voltage, C46=100nF, no major distortions

Ch4: Tek TCPA300, Ch1: Fluke 80i-110S

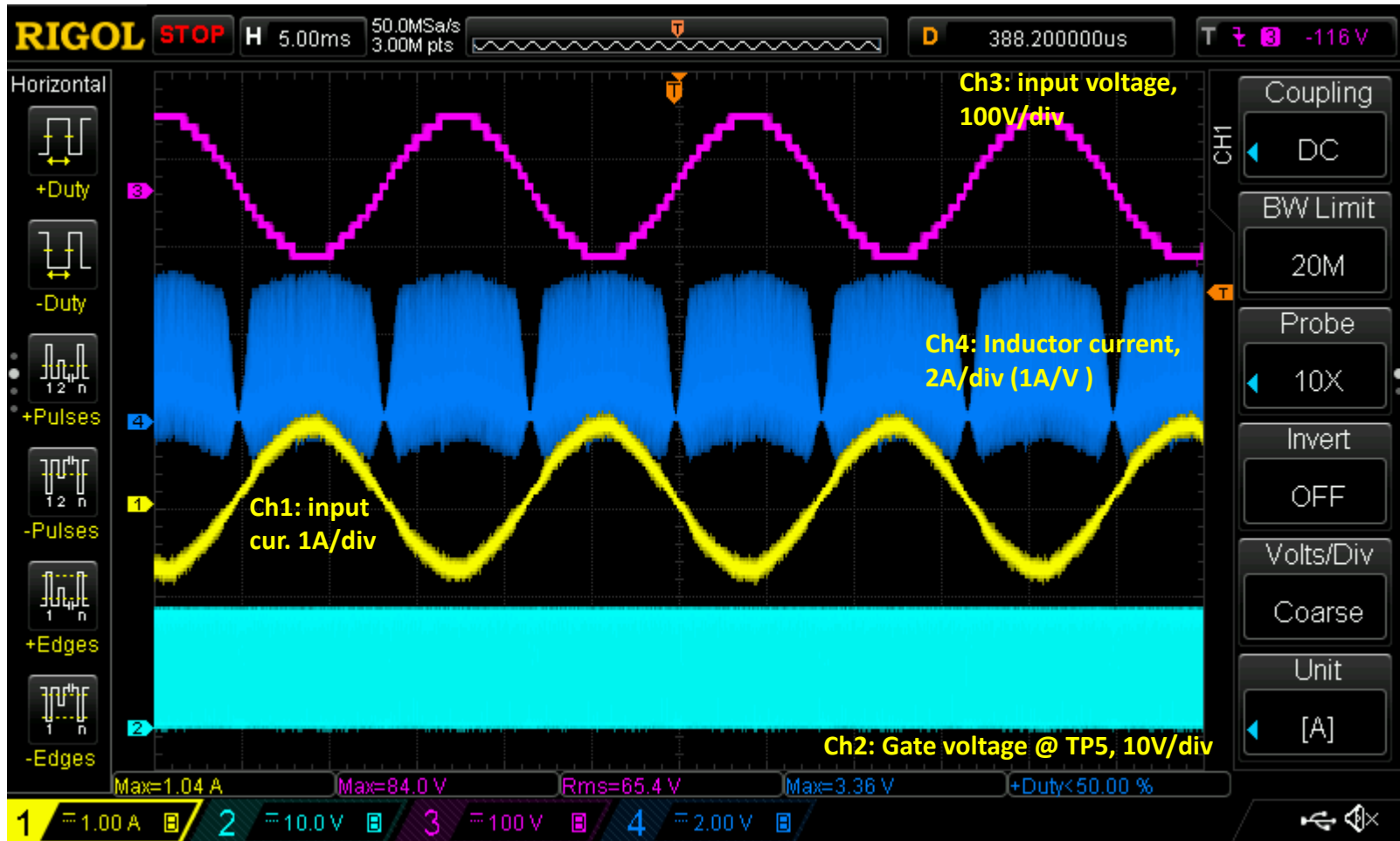

Measuring inductor current vs gate voltages, 12/28

Ch1: Fluke 80i-110S, which has limited bandwidth

Ch4: Tek TCPA300 w/ TCP312 Current probe

Per changes listed on page 55

At ~140Vac input voltage, $C46=100\text{nF}$, no major distortions

Ch4: Tek TCPA300, Ch1: Fluke 80i-110S

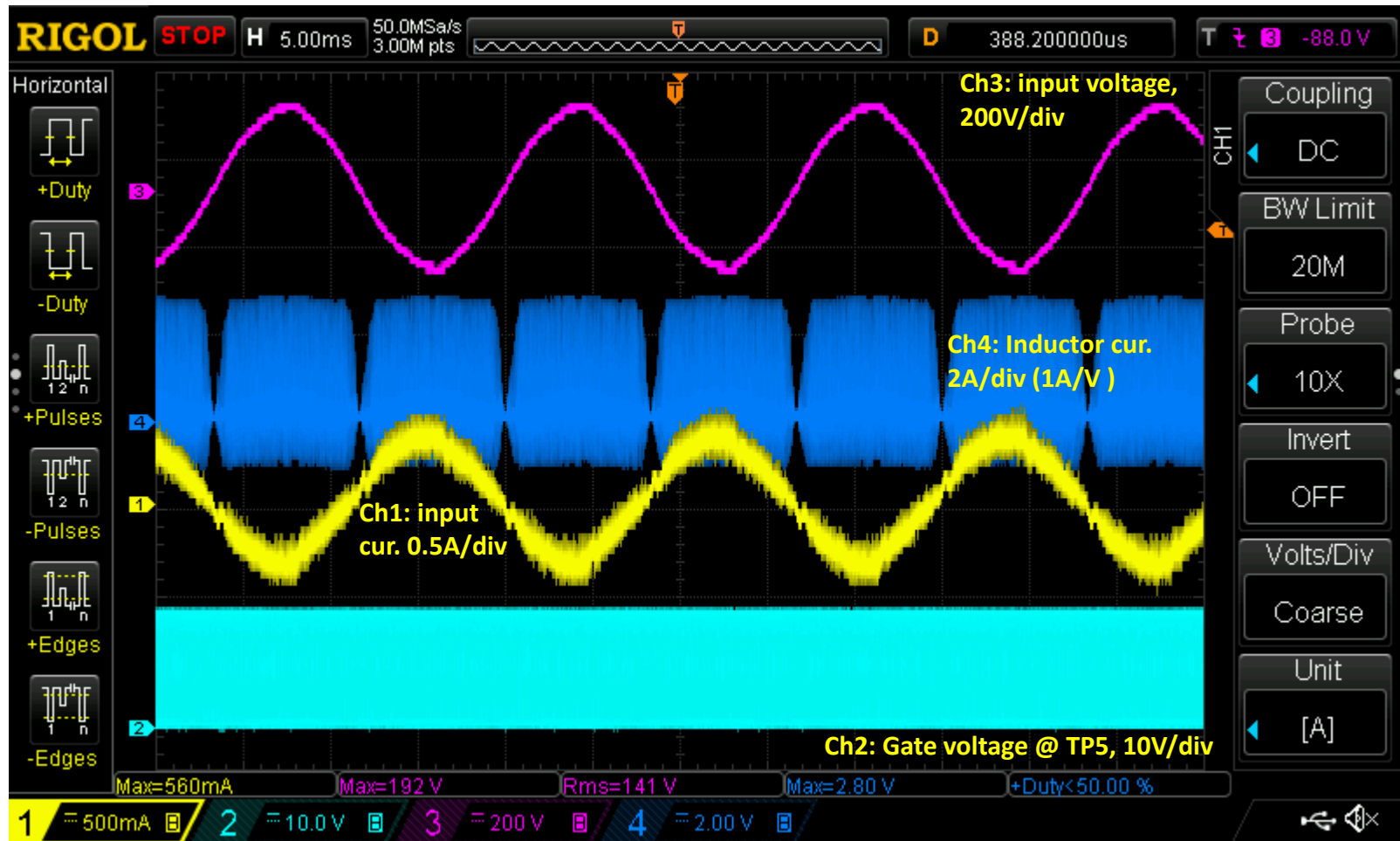

Measuring inductor current vs gate voltages, 12/28

Ch1: Fluke 80i-110S, which has limited bandwidth

Ch4: Tek TCPA300 w/ TCP312 Current probe

Per changes listed on page 55

At ~230Vac input voltage, C46=100nF, symmetric distortions show up on peaks of voltage waveform

Ch4: Tek TCPA300, Ch1: Fluke 80i-110S

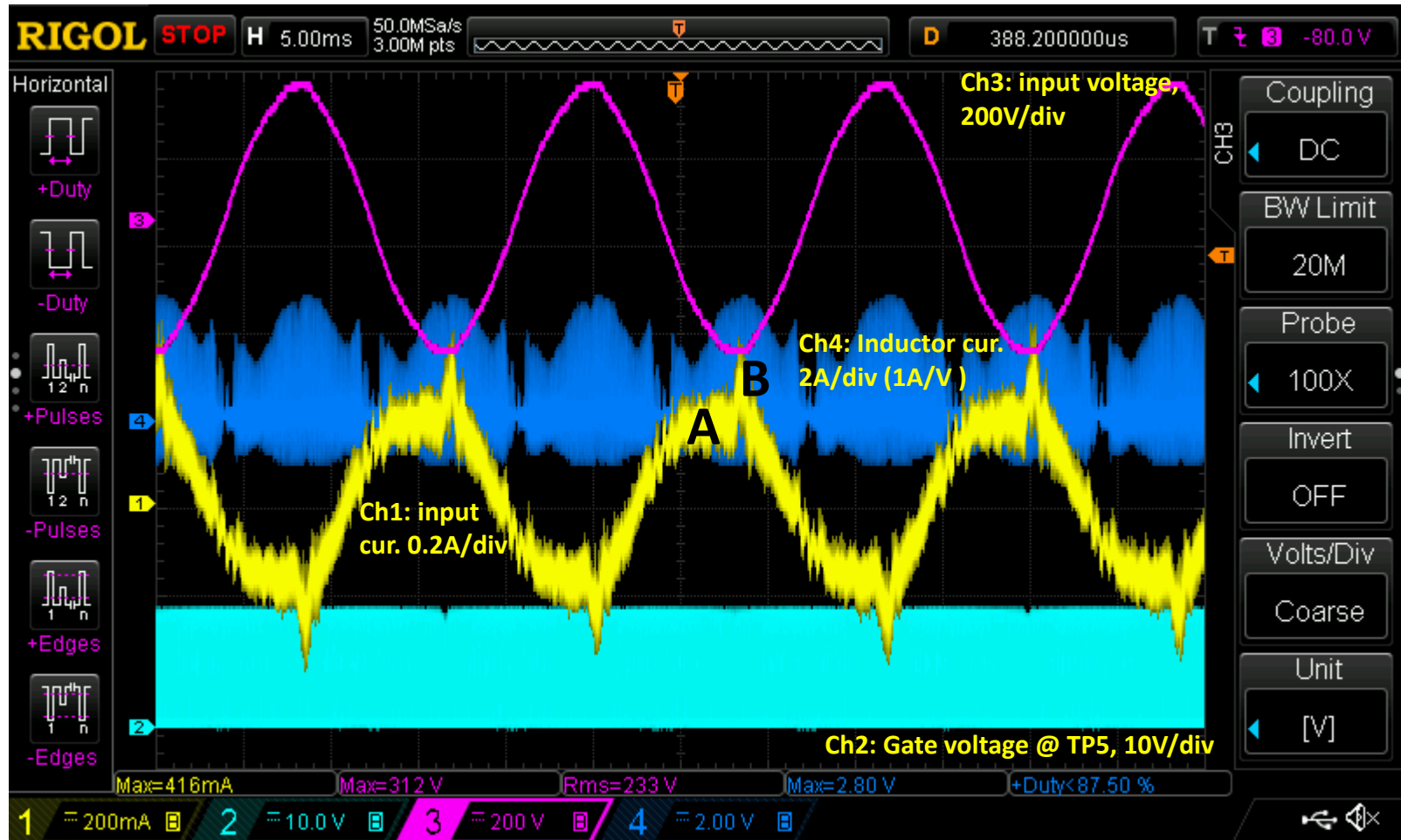

Measuring inductor current vs gate voltages, 12/28

Ch1: Fluke 80i-110S, which has limited bandwidth

Ch4: Tek TCPA300 w/ TCP312 Current probe

Per changes listed on page 55

At ~230Vac input voltage, $C46=100\text{nF}$, location A; ON times gets very small & pulses start to drop

Ch4: Tek TCPA300, Ch1: Fluke 80i-110S

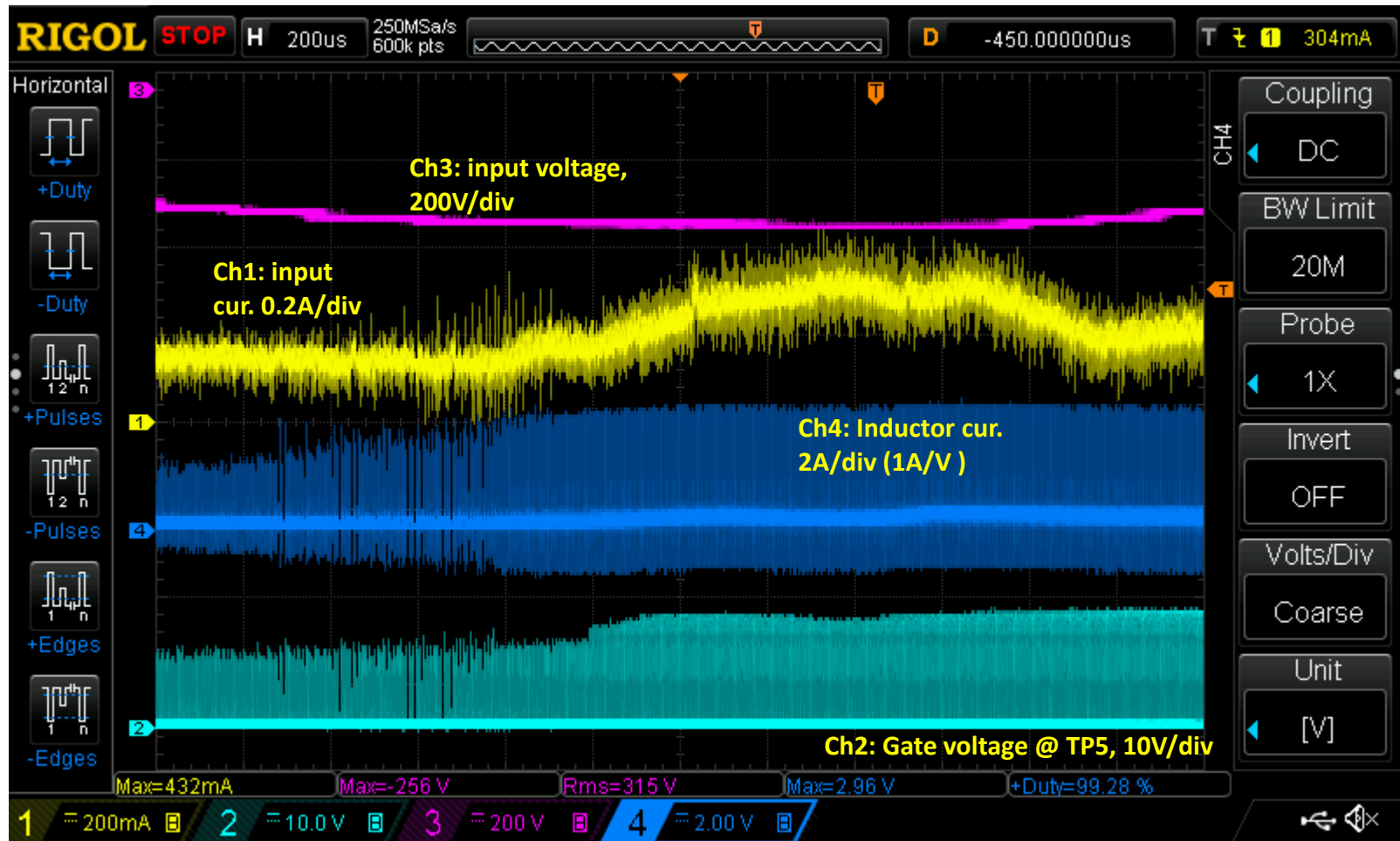

Measuring inductor current vs gate voltages, 12/28

Ch1: Fluke 80i-110S, which has limited bandwidth

Ch4: Tek TCPA300 w/ TCP312 Current probe

Per changes listed on page 55

At $\sim 230\text{Vac}$ input voltage, $C_{46}=100\text{nF}$, location A; ON times gets very small & pulses start to drop

Ch4: Tek TCPA300, Ch1: Fluke 80i-110S

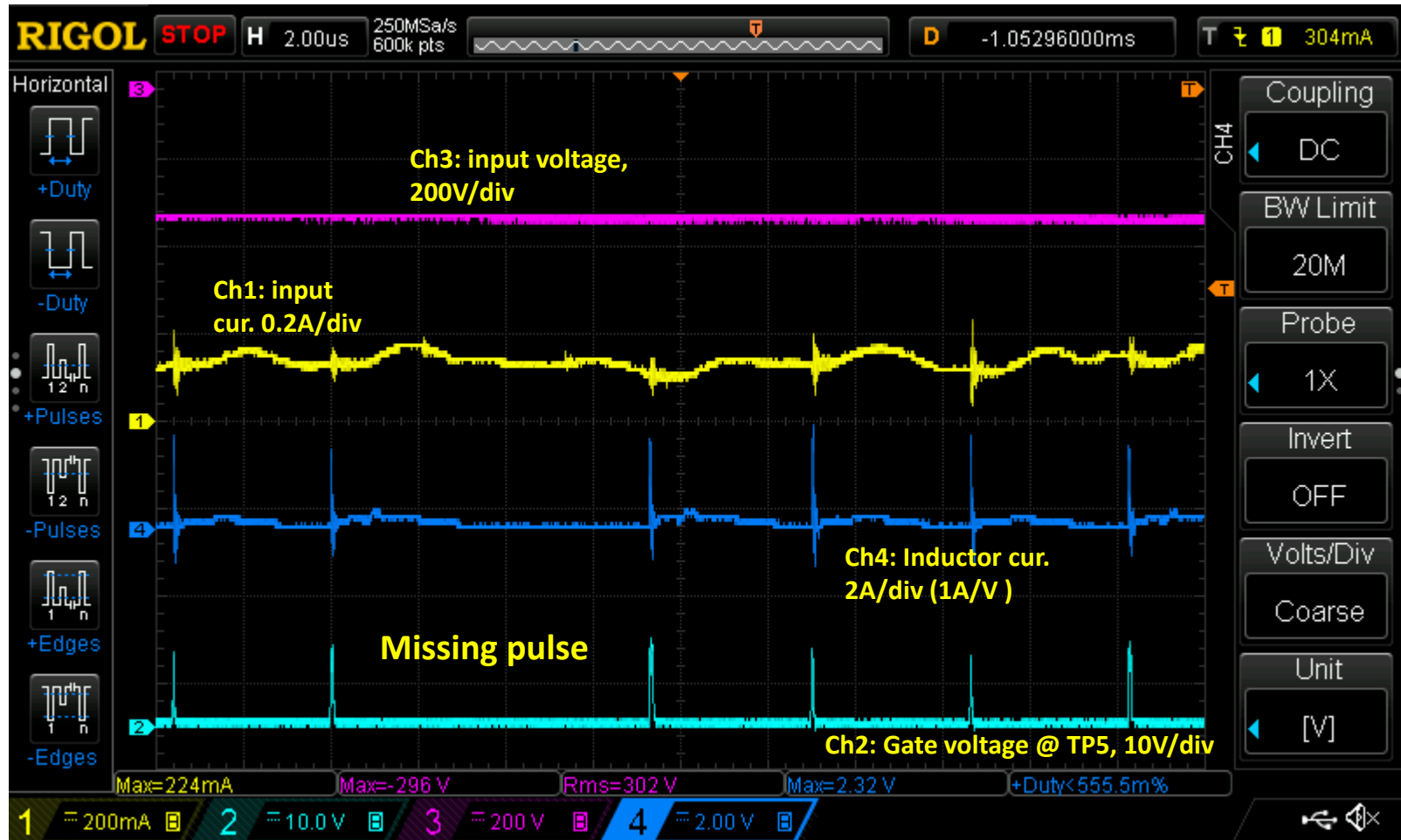

Measuring inductor current vs gate voltages, 12/28

Ch1: Fluke 80i-110S, which has limited bandwidth

Ch4: Tek TCPA300 w/ TCP312 Current probe

Per changes listed on page 55

Conclusions on 12/28:

- 1) Removing the 47nF cap across the sense resistor made the issue worse that the current became more unstable and distortions started even at low voltages of $\sim 100\text{Vac}$
- 2) Replacing the capacitor across the sense resistor (C46) with 100nF, did not improve the problem that the current waveform was stable up to $\sim 230\text{Vac}$ and distortions started above this voltage, as it was the case with C46=47nF
- 3) Referring to location A; it appears that the duty cycle gets very small and even some pulses were dropped even though the current through the inductor does not appear to be the max. This suggests that the event is not initiated by peak current limit
- 4) Referring to location B; at this point no pulse dropping is observed. On the contrary, the duty-cycle increases which results in surge in inductor current.