



## SPECIFICATIONS

CUSTOMER : \_\_\_\_\_

SAMPLE CODE : SH800480T024-IHC01

MASS PRODUCTION CODE : PH800480T024-IHC01

SAMPLE VERSION : 01

SPECIFICATIONS EDITION : 001

DRAWING NO. (Ver.) : LMD-PH800480T024-IHC01(Ver.001)

PACKAGING NO. (Ver.) : \_\_\_\_\_

**Customer Approved**

---

Date: \_\_\_\_\_

Approved	Checked	Designer
廖志豪 Rex Liao	張慶源 Yuan Chang	陳宗淇 Howard Chen

- Preliminary specification for design input
- Specification for sample approval

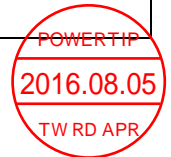

### POWERTIP TECH. CORP.

**Headquarters:** No.8, 6<sup>th</sup> Road, Taichung Industrial Park, Taichung, Taiwan  
 台中市 407 工業區六路 8 號

TEL: 886-4-2355-8168  
 FAX: 886-4-2355-8166

E-mail: [sales@powertip.com.tw](mailto:sales@powertip.com.tw)  
 Http://www.powertip.com.tw



## History of Version

Date (mm / dd / yyyy)	Ver.	Edi.	Description	Page	Design by
08/05/2016	01	001	New Drawing.	-	Howard

Total: 28 Pages

## Contents

### 1. SPECIFICATIONS

- 1.1 Features
- 1.2 Mechanical Specifications
- 1.3 Absolute Maximum Ratings
- 1.4 DC Electrical Characteristics
- 1.5 Optical Characteristics
- 1.6 Backlight Characteristics
- 1.7 Touch Panel Characteristics

### 2. MODULE STRUCTURE

- 2.1 Counter Drawing
- 2.2 Interface Pin Description
- 2.3 Timing Characteristics

### 3. QUALITY ASSURANCE SYSTEM

- 3.1 Quality Assurance Flow Chart
- 3.2 Inspection Specification

### 4. RELIABILITY TEST

- 4.1 Reliability Test Condition

### 5. PRECAUTION RELATING PRODUCT HANDLING

- 5.1 Safety
- 5.2 Handling
- 5.3 Storage
- 5.4 Terms of Warranty

Appendix : LCM Drawing

Note : For detailed information please refer to IC data sheet :

Primacy(TFT LCD): ILITEK: ILI6122M-9G / ILI5960-9G

## 1. SPECIFICATIONS

### 1.1 Features

Item	Standard Value
Display Resolution	800 * 3 (RGB) * 480 Dots
LCD Type	a-Si TFT , Normally white, Transmissive type
Screen size(inch)	5.0 inch
Viewing Direction	6 O'clock
Surface treatment	Anti-Glare
Color configuration	RGB Vertical Strip
Backlight Type	White LED B/L
Weight	-
Interface	24 Bits RGB interface
ROHS	THIS PRODUCT CONFORMS THE ROHS OF PTC Detail information please refer website : <a href="http://www.powertip.com.tw/news.php?area_id_view=1085560481/">http://www.powertip.com.tw/news.php?area_id_view=1085560481/</a>

### 1.2 Mechanical Specifications

Item	Standard Value	Unit
Outline Dimension	131.0(W) x 90.5 (L) x 4.5(H)	mm

#### LCD panel

Item	Standard Value	Unit
Active Area	108.0 (W) * 64.8 (L)	mm
Pixel Size	0.135 (W) * 0.135 (H)	mm

#### Touch panel

Item	Standard Value	Unit
Viewing Area	110.0 (W) * 66.8 (L)	mm

Note : For detailed information please refer to LCM drawing

### 1.3 Absolute Maximum Ratings

#### Module

Item	Symbol	Condition	Min.	Max.	Unit	Remark
Power Supply Voltage	DVDD	GND=0	-0.3	4.5	V	-
Power Supply Voltage	VCC	GND=0	-0.3	+12.0	V	
Operating Temperature	T <sub>OP</sub>	-	-20	70	°C	
Storage Temperature	T <sub>ST</sub>	-	-30	80	°C	

### 1.4 DC Electrical Characteristics

#### Module

GND = 0V, Ta = 25 °C

Item	Symbol	Min.	Typ.	Max.	Unit	Remark
Supply Voltage	DV <sub>DD</sub>	3.0	3.3	3.6	V	-
	V <sub>GH</sub>	15.3	16.0	16.7		
	V <sub>GL</sub>	-6.7	-6.0	-5.3		
	AV <sub>DD</sub>	10.3	10.4	10.5		
VCOM	V <sub>COM</sub>	3.3	3.7	4.1	V	
Input signal Voltage	V <sub>IH</sub>	0.7DV <sub>DD</sub>	-	DV <sub>DD</sub>	V	
	V <sub>IL</sub>	0	-	0.3DV <sub>DD</sub>		
Supply Current	I (DV <sub>DD</sub> )	-	(5)	-	mA	Pattern= - *1
	I (AV <sub>DD</sub> )	-	(25)	-		Pattern= -
	I <sub>GH</sub>	-	(0.55)	-		Pattern= -
	I <sub>GL</sub>	-	(0.60)	-		Pattern= -

Note1: Maximum current display.

## 1.5 Optical Characteristics

### TFT LCD Module

DVDD= 3.3 V, Ta=25°C

Item		Symbol	Condition	Min.	Typ.	Max.	unit	-
Response time	Tr+Tf	25°C	-	-	35	55	ms	-
Viewing angle	Top	$\theta Y+$	CR $\geq$ 10		60	-	Deg.	Note 4
	Bottom	$\theta Y-$			60	-		
	Left	$\theta X-$			60	-		
	Right	$\theta X+$			60	-		
Contrast ratio		CR		(500)	(600)	-	-	Note 3
Color of CIE Coordinate (With B/L & TP)	White	X	Ta = 25°C $\theta X, \theta Y = 0^\circ$	-	(0.30)	-	-	Note1
		Y		-	(0.32)	-		
	Red	X		-	(0.56)	-		
		Y		-	(0.33)	-		
	Green	X		-	(0.35)	-		
		Y		-	(0.60)	-		
	Blue	X		-	(0.15)	-		
		Y		-	(0.09)	-		
Average Brightness Pattern=white display (With LCD & TP)*1		IV	IF=(90)mA	(680)	(850)	-	cd/m2	Note1
Uniformity (With LCD & TP)*2		$\Delta B$	IF=(90)mA	(70)	-	-	%	Note1

Note 1:

\*1 :  $\Delta B = B(\text{min}) / B(\text{max}) * 100\%$

\*2 : Measurement Condition for Optical Characteristics:

- a : Environment:  $25^{\circ}\text{C} \pm 5^{\circ}\text{C}$  /  $60 \pm 20\% \text{R.H}$  , no wind , dark room below 10 Lux at typical lamp current and typical operating frequency.
- b : Measurement Distance:  $500 \pm 50$  mm , ( $\theta = 0^{\circ}$ )
- c : Equipment: TOPCON BM-7 fast , (field  $1^{\circ}$ ) , after 10 minutes operation.
- d : The uncertainty of the C.I.E coordinate measurement  $\pm 0.01$  , Average Brightness  $\pm 4\%$

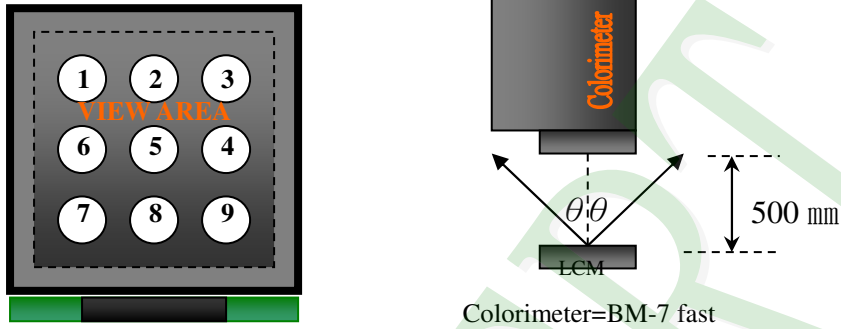

To be measured at the center area of panel with a viewing cone of  $1^{\circ}$  by Topcon luminance meter BM-7, after 10 minutes operation (module)

Note2: Definition of response time:

The output signals of photo detector are measured when the input signals are changed from "black" to "white"(falling time) and from "white" to "black"(rising time), respectively. The response time is defined as the time interval between the 10% and 90% of Amplitudes.

Refer to figure as below:

Normally White



### Normally Black

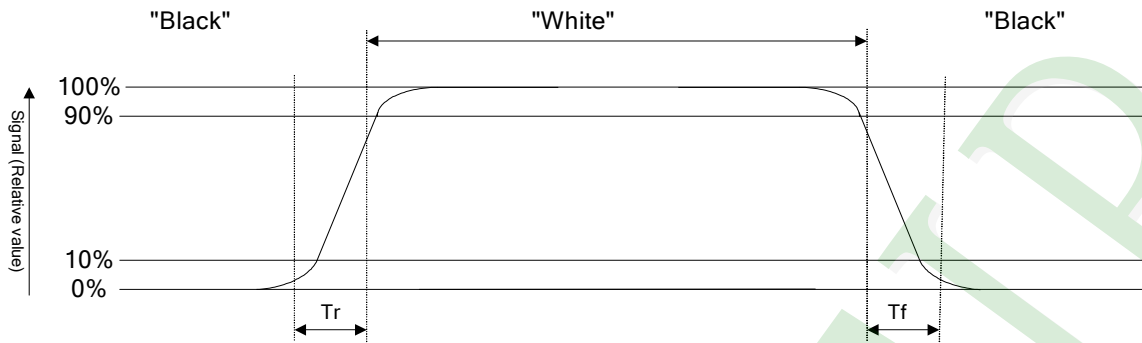

Note3: Definition of contrast ratio:

Contrast ratio is calculated with the following formula

$$\text{Contrast ratio (CR)} = \frac{\text{Photo detector output when LCD is at "White" state}}{\text{Photo detector output when LCD is at "Black" state}}$$

Note4: Definition of viewing angle:

Refer to figure as below:

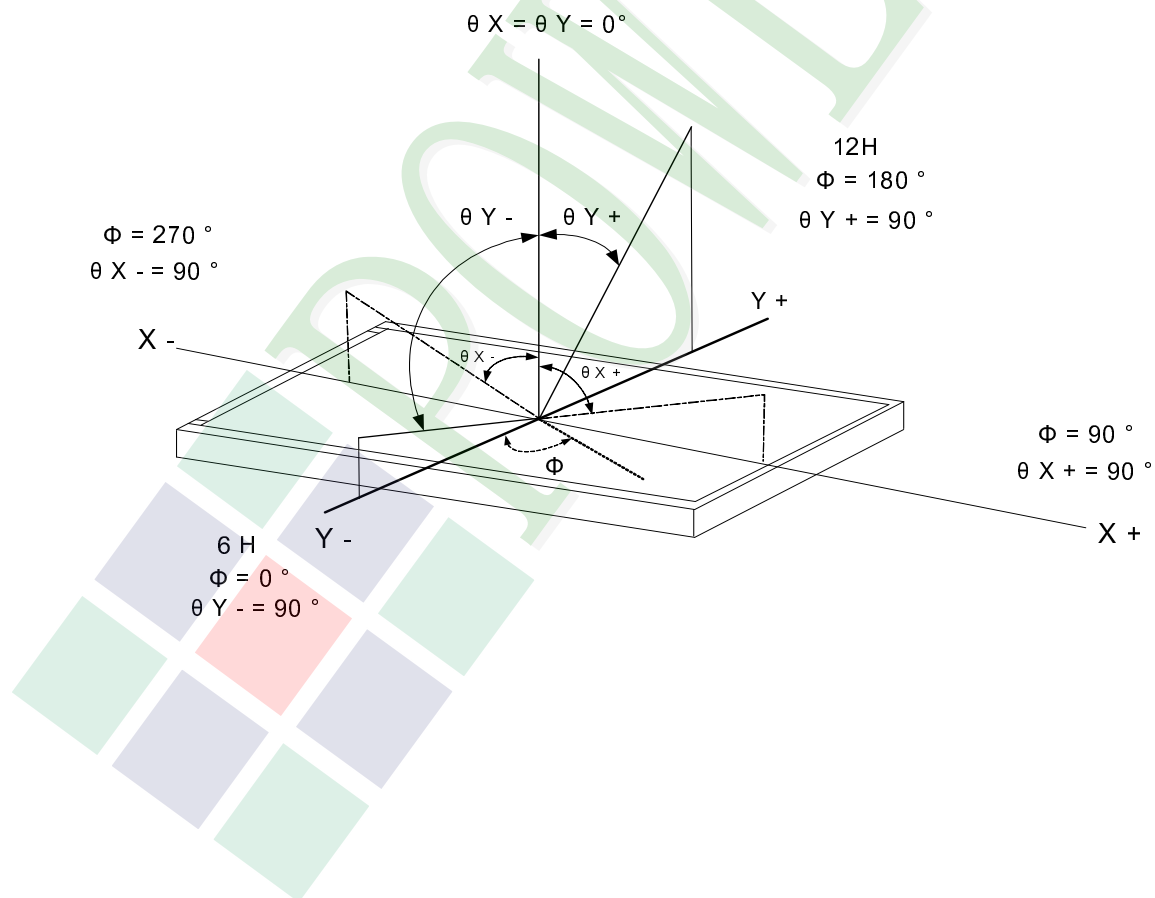



## 1.6 Backlight Characteristics

### Maximum Ratings

Item	Symbol	Min.	Max.	Unit	Remark
LED Forward Current	$I_F$	210		mA	One LED
LED Reverse Voltage	$V_R$	10		V	

### Electrical / Optical Characteristics

Item	Symbol	Conditions	Min.	Typ.	Max.	Unit
Forward Voltage	$V_F$	$I_F=(90)\text{mA}$	(16.2)	(18.0)	(19.2)	V
Average Brightness (Without LCD )	$I_V$		(20000)	(23000)	-	cd/m <sup>2</sup>
CIE Color Coordinate (Without LCD )	X		(0.25)	(0.28)	(0.31)	-
	Y		(0.25)	(0.28)	(0.31)	
Color	White					

Note 1: The LED Supply Voltage is defined by the number of LED at  $T_a=25^\circ\text{C}$  and  $I_L=90\text{ mA}$ .

Note 2: The "LED life time" is defined as the module brightness decrease to 50% original brightness at  $T_a=25^\circ\text{C}$  and  $I_L=90\text{ mA}$ . The LED life time could be decreased if operating  $I_L$  is larger than 90 mA.

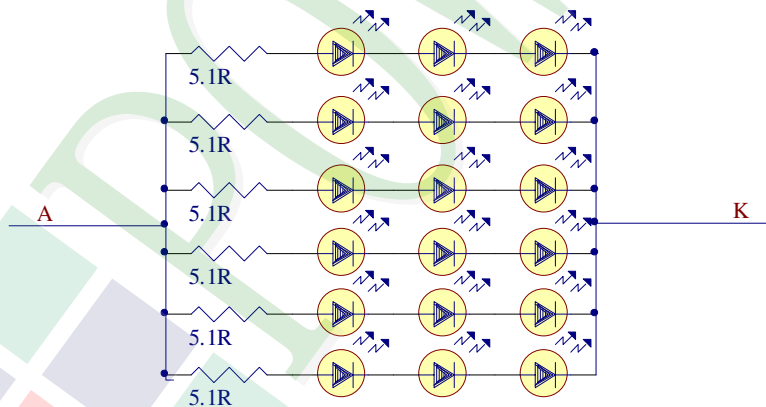

### Other Description

Item	Conditions	Description
Life Time	$T_a=25^\circ\text{C}$ $I_F=90\text{mA}$	50,000 hrs

## 1.7 Touch Panel Characteristics

### Features

Item	Standard Value
Touch Panel Size	5.0"
Touch type	Capacitive Touch Panel
Input Method	True Multi-Touch Capacitive Touch Panel True Multi-touch with up to 5 Points of Absolution
Output Interface	I <sup>2</sup> C
IC	ST1633

### Mechanical Specifications

Item	Standard Value	Unit
Viewing Area	110.0 (W) * 66.8 (L)	mm
Number of sensing channel	-	mm

### Absolute Maximum Ratings

Item	Symbol	Condition	Min.	Max.	Unit
Operating Temperature	T <sub>OP</sub>	-	-20	70	°C
Storage Temperature	T <sub>ST</sub>	-	-30	80	°C

### DC Electrical Characteristics

Item	Symbol	Condition	Min.	Typ.	Max.	Unit
LCM driving voltage	V <sub>DD</sub>	25°C	-	3.3	-	V
Input Signal Voltage	V <sub>IH</sub>		0.85 x V <sub>DD</sub>	-	-	V
	V <sub>IL</sub>		-	-	0.15 x V <sub>DD</sub>	V

### Optical Characteristics

Item	Standard Value	Unit
Response Time	≤25ms	
Total light transmittance	85% or more	-
Surface Hardness	≥6H	-

## 2. MODULE STRUCTURE

### 2.1 Counter Drawing

#### 2.1.1 LCM Mechanical Diagram

\* See Appendix

#### 2.1.2 Block Diagram

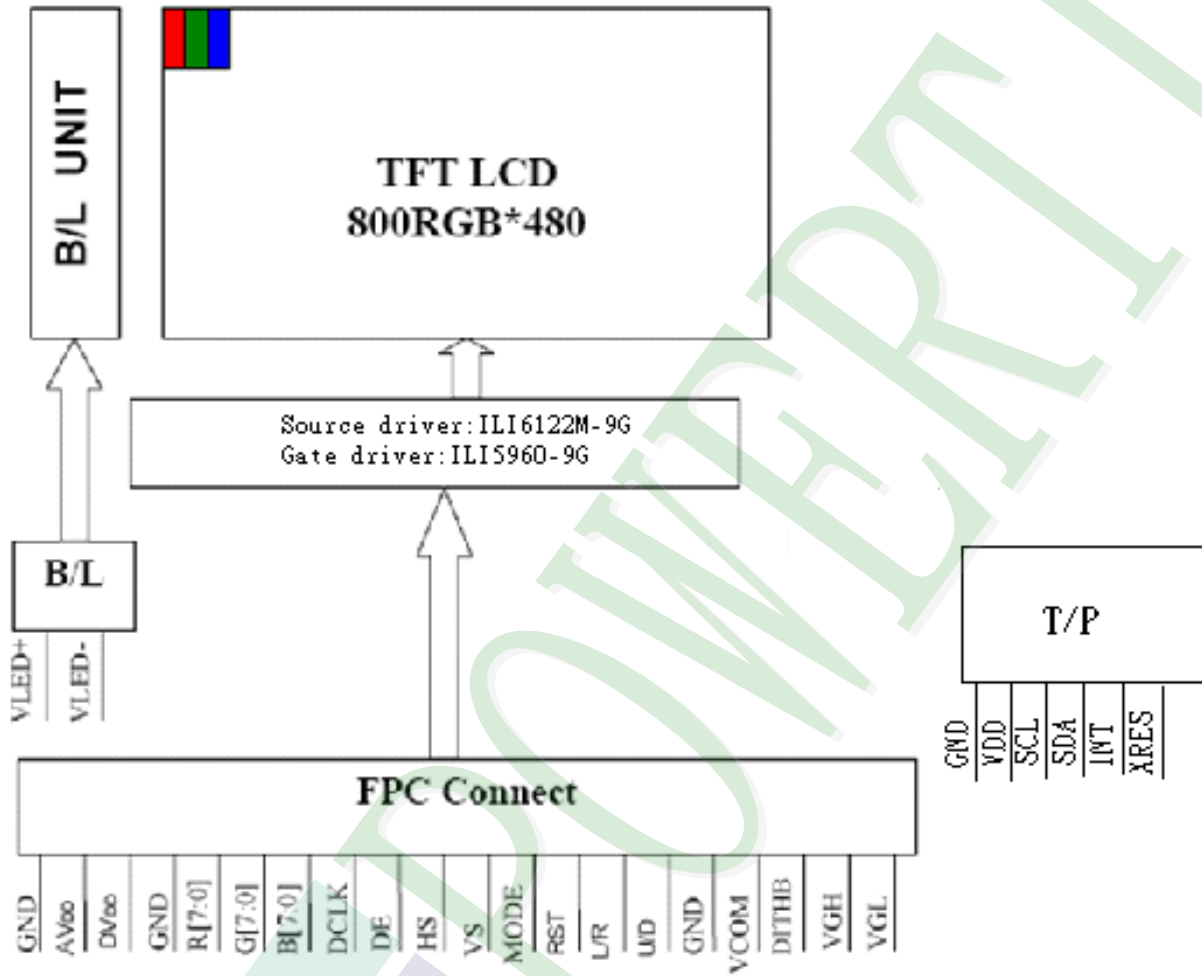

## 2.2 Interface Pin Description

Pin#	Name	DESCRIPTION
1	V <sub>LED+</sub>	Power For LED backlight (+).
2	V <sub>LED+</sub>	Power For LED backlight (+).
3	V <sub>LED-</sub>	Power For LED backlight (-).
4	V <sub>LED-</sub>	Power For LED backlight (-).
5	GND	Power ground.
6	V <sub>com</sub>	Common voltage.
7	DV <sub>DD</sub>	Power for Digital Circuit.
8	MODE	DE/SYNC mode select.
9	DE	Data Input Enable.
10	VS	Vertical Sync Input.
11	HS	Horizontal Sync Input.
12	B7	Blue Data(MSB).
13	B6	Blue Data.
14	B5	Blue Data.
15	B4	Blue Data.
16	B3	Blue Data.
17	B2	Blue Data.
18	B1	Blue Data.
19	B0	Blue Data(LSB).
20	G7	Green Data(MSB).
21	G6	Green Data.
22	G5	Green Data.
23	G4	Green Data.
24	G3	Green Data.
25	G2	Green Data.
26	G1	Green Data.
27	G0	Green Data(LSB).
28	R7	Red Data(MSB).
29	R6	Red Data.

Pin#	Name	DESCRIPTION
30	R5	Red Data.
31	R4	Red Data.
32	R3	Red Data.
33	R2	Red Data.
34	R1	Red Data.
35	R0	Red Data(LSB).
36	GND	Power Ground
37	DCLK	Sample clock, latch data at falling edge
38	GND	Power Ground.
39	L/R	Left / right selection.
40	U/D	Up / Down selection.
41	V <sub>GH</sub>	Gate On Voltage.
42	V <sub>GL</sub>	Gate OFF Voltage.
43	AV <sub>DD</sub>	Power for Analog Circuit.
44	RESET	Global reset pin.
45	NC	No connection.
46	V <sub>COM</sub>	Common Voltage.
47	DITHB	Dithering Function.
48	GND	Power Ground.
49	NC	No connection.
50	NC	No connection.

### Touch Panel Driving

Pin No.	Symbol	Function
1	GND	Touch Panel Ground.
2	VDD	Power Supply Voltage (3.3V)
3	SCL	I2C Clock
4	SDA	I2C Data
5	INT	Active Low
6	XRES	Active low global reset signal input.

## 2.3 Timing Characteristics

### 2.3.1 Input Clock and Data Timing

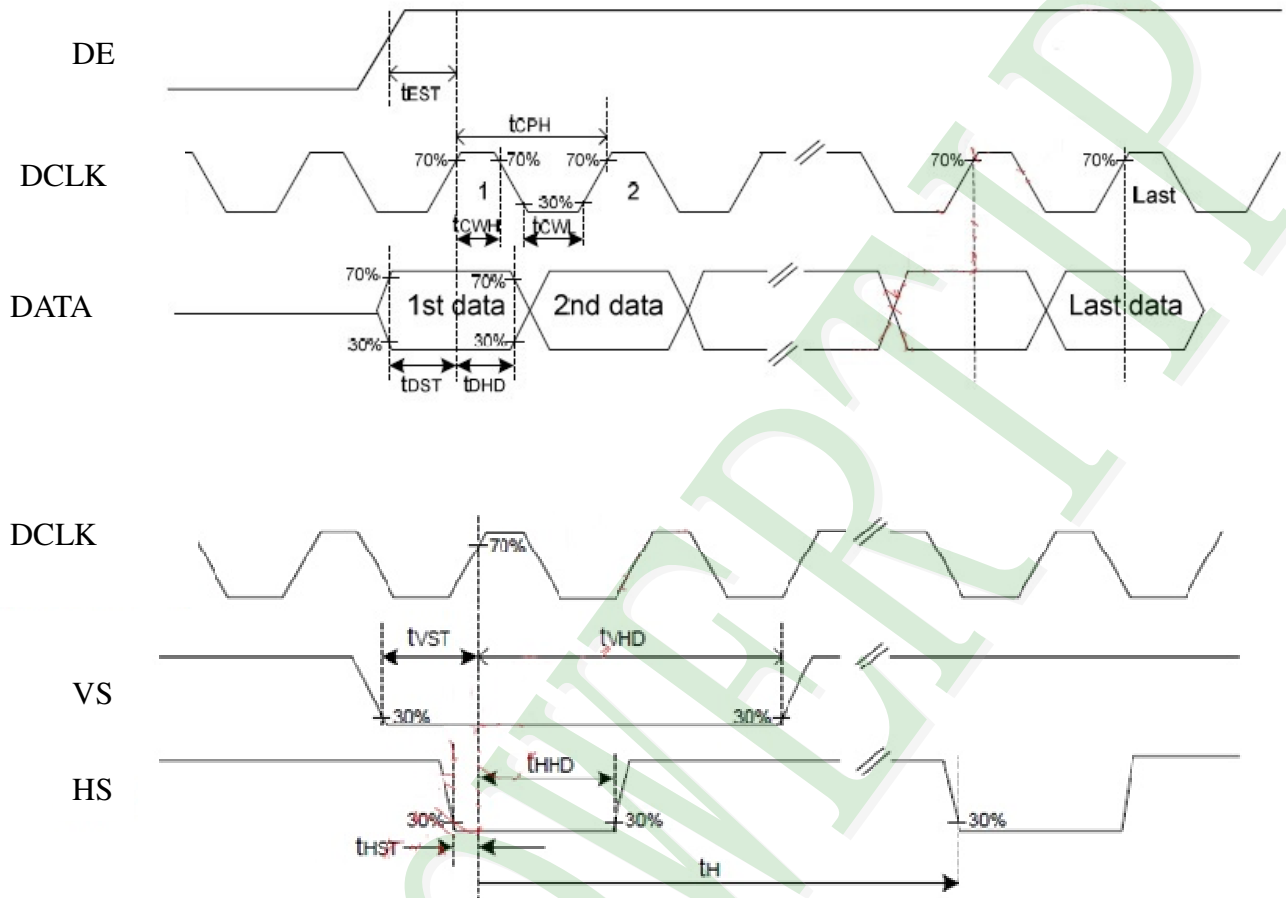

Parameter	Symbol	Spec			Unit	Conditions
		Min.	Typ.	Max.		
VDD Power ON slew rate	$t_{POR}$	--	--	20	ms	0V ~ 0.9VDD
RSTB pulse width	$t_{RST}$	10	--	--	us	CLKIN=50MHz
CLKIN cycle time	$t_{CPH}$	20	--	--	ns	
CLKIN pulse duty	$t_{CWH}$	40	50	60	%	
VSD setup time	$t_{VST}$	8	--	--	ns	
VSD hold time	$t_{VHD}$	8	--	--	ns	
HSD setup time	$t_{HST}$	8	--	--	ns	
HSD hold time	$t_{HHD}$	8	--	--	ns	
Data setup time	$t_{DST}$	8	--	--	ns	D0[7:0], D1[7:0], D2[7:0] to CLKIN
Data hold time	$t_{DHD}$	8	--	--	ns	D0[7:0], D1[7:0], D2[7:0] to CLKIN
DE setup time	$t_{EST}$	8	--	--	ns	
DE hold time	$t_{EHD}$	8	--	--	ns	
Output stable time	$t_{SST}$	--	--	6	us	10% to 90% target voltage. CL=120pF, R=10K $\Omega$
CLKIN frequency	$f_{CLK}$	--	40	50	MHz	VDD=3.0 ~ 3.6V
CLKIN cycle time	$t_{CLK}$	20	25	--	ns	
CLKIN pulse duty	$t_{CWH}$	40	50	60	%	$T_{CLK}$
Time from HSD to Source output	$t_{HSO}$	--	20	--	CLKIN	
Time from HSD to LD	$t_{HLD}$	--	20	--	CLKIN	Note (2)
Time from HSD to STV	$t_{HSTV}$	--	2	--	CLKIN	
Time from HSD to CKV	$t_{HCKV}$	--	20	--	CLKIN	
Time from HSD to OEV	$t_{HOEV}$	--	4	--	CLKIN	
LD pulse width	$t_{WLD}$	--	10	--	CLKIN	Note (2)
CKV pulse width	$t_{WCKV}$	--	66	--	CLKIN	
OEV pulse width	$t_{WOEV}$	--	74	--	CLKIN	

Note: (1) VDD=3.0 ~ 3.6V, VDDA=6.5~13.5V, DGND=AGND=0V, Ta=-20~+85°C

(2) The contents of the data register are transferred to the latch circuit at the rising edge of LD. Then the gray scale voltage is output from the device at the falling edge of LD.

### 2.3.2 Vertical input timing

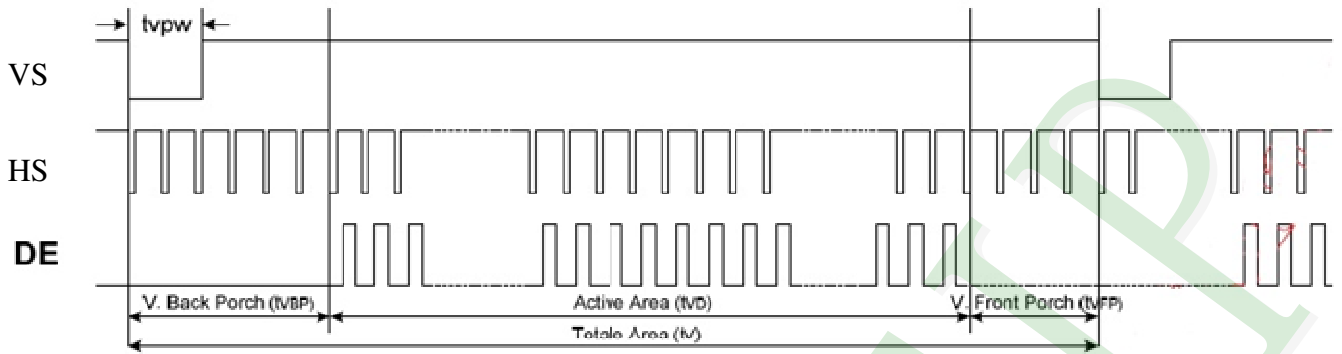

Parameter	Symbol	Value			Unit
		Min	Typ	Max	
Vertical display area	tvd		480		H
VSYNC period time	tv	510	525	650	H
VSYNC pulse width	tpw	1	-	20	H
VSYNC ack Porch(Blanking)	tvb	23	23	23	H
VSYNC Front Proch	tvfb	7	22	147	H



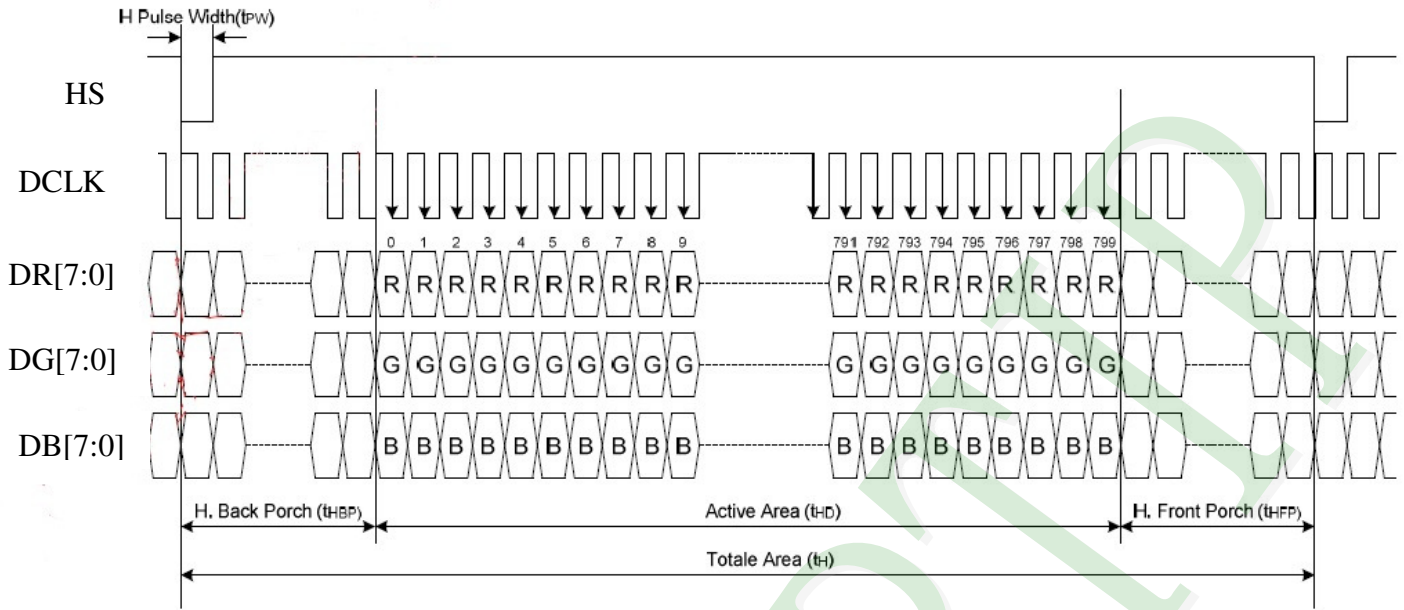

Parameter	Symbol	Value			Unit
		Min	Typ	Max	
Horizontal display area	thd		800		DCLK
DCLK frequency	fclk	-	33.3	50	MHz
1 Horizontal Line	th	862	1056	1200	DCLK
HSD pulse width	Min	-	1		
	Typ	-	-		
	Max	-	40		
HSD Back Porch (Blacking)	thp	46	46	46	
HSD Front Proch	thfb	16	210	354	

### 3. QUALITY ASSURANCE SYSTEM

#### 3.1 Quality Assurance Flow Chart

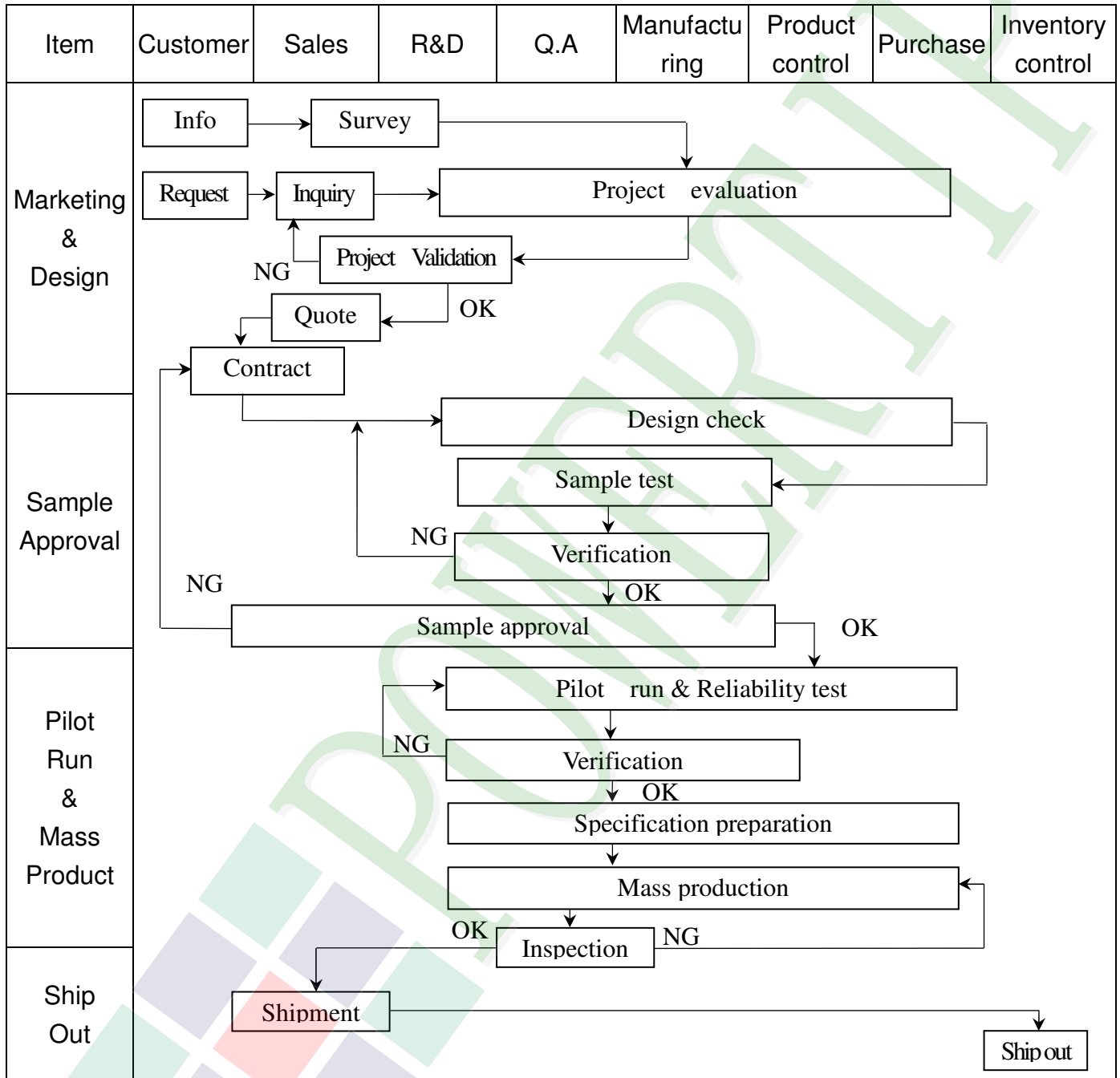

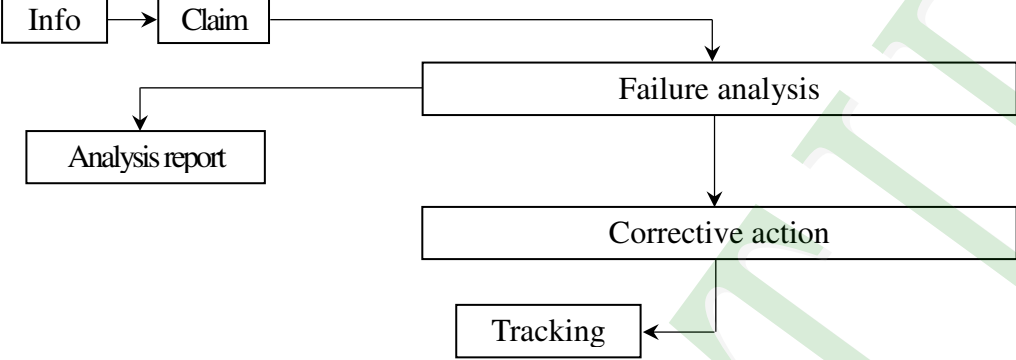
Item	Customer	Sales	R&D	Q.A	Manufacturing	Product control	Purchase	Inventory control
Sales Service	 <pre> graph TD     Info[Info] --&gt; Claim[Claim]     Claim --&gt; FA[Failure analysis]     Claim --&gt; AR[Analysis report]     FA --&gt; CA[Corrective action]     CA --&gt; Tracking[Tracking]           </pre>							
Q.A Activity	1. ISO 9001 Maintenance Activities 3. Equipment calibration 5. Standardization Management				2. Process improvement proposal 4. Education And Training Activities			

### 3.2 Inspection Specification

- ◆Scope : The document shall be applied to TFT-LCD Module for 3.5" ~10" (Ver.B01).
- ◆Inspection Standard : MIL-STD-105E Table Normal Inspection Single Sampling Level II.
- ◆Equipment : Gauge 、 MIL-STD 、 Powertip Tester 、 Sample
- ◆Defect Level : Major Defect AQL : 0.4 ; Minor Defect AQL : 1.5
- ◆OUT Going Defect Level : Sampling.
- ◆Standard of the product appearance test :

a. Manner of appearance test :

- (1). The test best be under 20W×2 fluorescent light , and distance of view must be at 30 cm.
- (2). The test direction is base on about around 45° of vertical line.

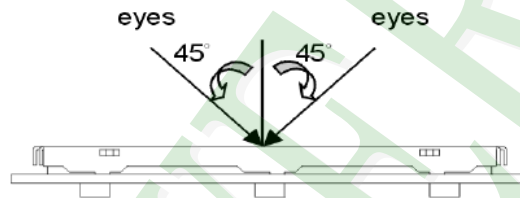

(3). Definition of area.

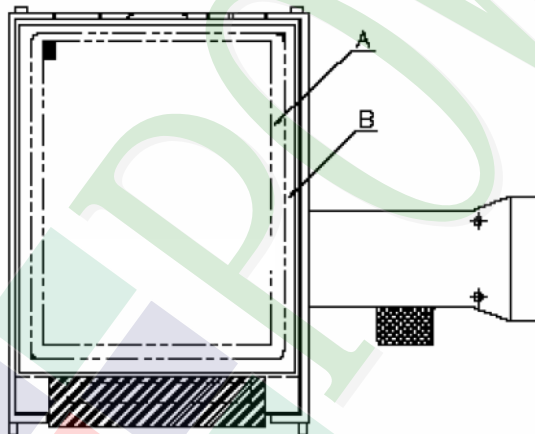

**A area : viewing area**

**B area : Outside of viewing area**

(4). Standard of inspection : (Unit : mm)



## ◆ Specification For TFT-LCD Module 3.5" ~10" :

(Ver.B01)

NO	Item	Criterion	Level										
01	Product condition	1. 1 The part number is inconsistent with work order of production.	Major										
		1. 2 Mixed product types.	Major										
		1. 3 Assembled in inverse direction.	Major										
02	Quantity	2. 1 The quantity is inconsistent with work order of production.	Major										
03	Outline dimension	3. 1 Product dimension and structure must conform to structure diagram.	Major										
04	Electrical Testing	4. 1 Missing line character and icon.	Major										
		4. 2 No function or no display.	Major										
		4. 3 Display malfunction.	Major										
		4. 4 LCD viewing angle defect.	Major										
		4. 5 Current consumption exceeds product specifications.	Major										
05	Dot defect (Bright dot 、 Dark dot)  On -display	<table border="1"> <thead> <tr> <th>Item</th> <th>Acceptance (Q'ty)</th> </tr> </thead> <tbody> <tr> <td>Bright Dot</td> <td><math>\leq 4</math></td> </tr> <tr> <td>Dark Dot</td> <td><math>\leq 5</math></td> </tr> <tr> <td>Joint Dot</td> <td><math>\leq 3</math></td> </tr> <tr> <td>Total</td> <td><math>\leq 7</math></td> </tr> </tbody> </table>	Item	Acceptance (Q'ty)	Bright Dot	$\leq 4$	Dark Dot	$\leq 5$	Joint Dot	$\leq 3$	Total	$\leq 7$	Minor
		Item	Acceptance (Q'ty)										
		Bright Dot	$\leq 4$										
		Dark Dot	$\leq 5$										
		Joint Dot	$\leq 3$										
Total	$\leq 7$												
5. 1 Inspection pattern : full white , full black , Red , Green and blue screens.													
5. 2 It is defined as dot defect if defect area $> 1/2$ dot.													
5. 3 The distance between two dot defect $\geq 5$ mm.													



◆ Specification For TFT-LCD Module 3.5" ~10" :

(Ver.B01)

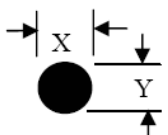
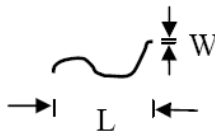
NO	Item	Criterion	Level																																						
06	<p>Black or white dot、scratch、contamination</p> <p>Round type</p>  <p><math>\Phi = (x+y) / 2</math></p> <p>Line type</p> 	<p>6.1 Round type ( Non-display or display ) :</p> <table border="1"> <thead> <tr> <th rowspan="2">Dimension (diameter : <math>\Phi</math>)</th> <th colspan="2">Acceptance (Q'ty)</th> </tr> <tr> <th>A area</th> <th>B area</th> </tr> </thead> <tbody> <tr> <td><math>\Phi \leq 0.25</math></td> <td colspan="2">Ignore</td> </tr> <tr> <td><math>0.25 &lt; \Phi \leq 0.50</math></td> <td>5</td> <td rowspan="3">Ignore</td> </tr> <tr> <td><math>\Phi &gt; 0.50</math></td> <td>0</td> </tr> <tr> <td><b>Total</b></td> <td>5</td> </tr> </tbody> </table> <p>6.2 Line type( Non-display or display ) :</p> <table border="1"> <thead> <tr> <th rowspan="2">Length (L)</th> <th rowspan="2">Width (W)</th> <th colspan="2">Acceptance (Q'ty)</th> </tr> <tr> <th>A area</th> <th>B area</th> </tr> </thead> <tbody> <tr> <td>--</td> <td><math>W \leq 0.03</math></td> <td>Ignore</td> <td rowspan="4">Ignore</td> </tr> <tr> <td><math>L \leq 10.0</math></td> <td><math>0.03 &lt; W \leq 0.05</math></td> <td>4</td> </tr> <tr> <td><math>L \leq 5.0</math></td> <td><math>0.05 &lt; W \leq 0.10</math></td> <td>2</td> </tr> <tr> <td>--</td> <td><math>W &gt; 0.10</math></td> <td>As round type</td> </tr> <tr> <td colspan="2"><b>Total</b></td> <td>5</td> <td></td> </tr> </tbody> </table>	Dimension (diameter : $\Phi$ )	Acceptance (Q'ty)		A area	B area	$\Phi \leq 0.25$	Ignore		$0.25 < \Phi \leq 0.50$	5	Ignore	$\Phi > 0.50$	0	<b>Total</b>	5	Length (L)	Width (W)	Acceptance (Q'ty)		A area	B area	--	$W \leq 0.03$	Ignore	Ignore	$L \leq 10.0$	$0.03 < W \leq 0.05$	4	$L \leq 5.0$	$0.05 < W \leq 0.10$	2	--	$W > 0.10$	As round type	<b>Total</b>		5		Minor
Dimension (diameter : $\Phi$ )	Acceptance (Q'ty)																																								
	A area	B area																																							
$\Phi \leq 0.25$	Ignore																																								
$0.25 < \Phi \leq 0.50$	5	Ignore																																							
$\Phi > 0.50$	0																																								
<b>Total</b>	5																																								
Length (L)	Width (W)	Acceptance (Q'ty)																																							
		A area	B area																																						
--	$W \leq 0.03$	Ignore	Ignore																																						
$L \leq 10.0$	$0.03 < W \leq 0.05$	4																																							
$L \leq 5.0$	$0.05 < W \leq 0.10$	2																																							
--	$W > 0.10$	As round type																																							
<b>Total</b>		5																																							
07	<p>Polarizer Bubble</p>	<table border="1"> <thead> <tr> <th rowspan="2">Dimension (diameter : <math>\Phi</math>)</th> <th colspan="2">Acceptance (Q'ty)</th> </tr> <tr> <th>A area</th> <th>B area</th> </tr> </thead> <tbody> <tr> <td><math>\Phi \leq 0.25</math></td> <td colspan="2">Ignore</td> </tr> <tr> <td><math>0.25 &lt; \Phi \leq 0.50</math></td> <td>4</td> <td rowspan="3">Ignore</td> </tr> <tr> <td><math>0.50 &lt; \Phi \leq 0.80</math></td> <td>1</td> </tr> <tr> <td><math>\Phi &gt; 0.80</math></td> <td>0</td> </tr> <tr> <td><b>Total</b></td> <td>5</td> <td></td> </tr> </tbody> </table>	Dimension (diameter : $\Phi$ )	Acceptance (Q'ty)		A area	B area	$\Phi \leq 0.25$	Ignore		$0.25 < \Phi \leq 0.50$	4	Ignore	$0.50 < \Phi \leq 0.80$	1	$\Phi > 0.80$	0	<b>Total</b>	5		Minor																				
Dimension (diameter : $\Phi$ )	Acceptance (Q'ty)																																								
	A area	B area																																							
$\Phi \leq 0.25$	Ignore																																								
$0.25 < \Phi \leq 0.50$	4	Ignore																																							
$0.50 < \Phi \leq 0.80$	1																																								
$\Phi > 0.80$	0																																								
<b>Total</b>	5																																								

**◆Specification For TFT-LCD Module 3.5" ~10" :**

(Ver.B01)

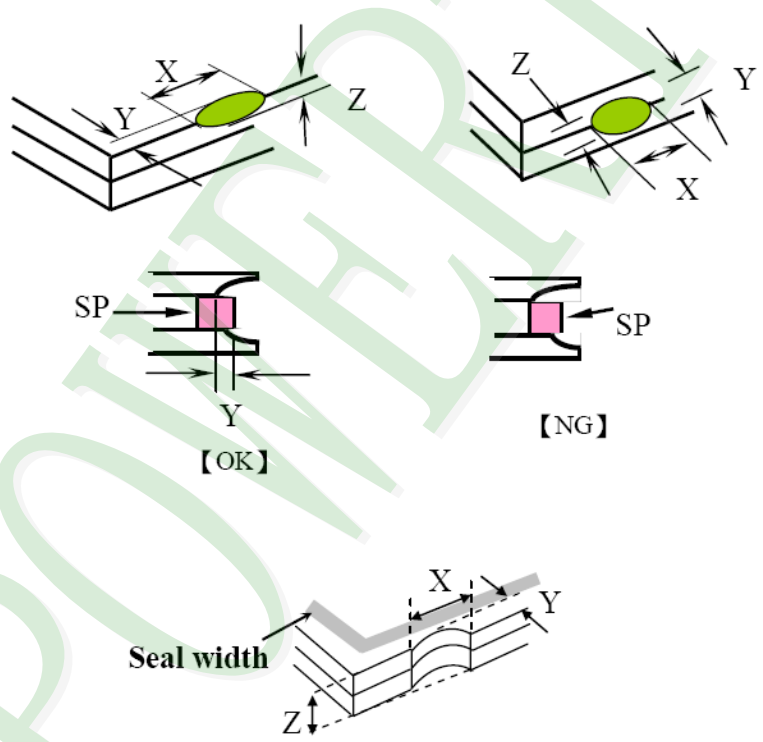
NO	Item	Criterion	Level						
08	The crack of glass	<p><b>Symbols :</b></p> <p><b>X : The length of crack</b>  <b>Z : The thickness of crack</b>  <b>t : The thickness of glass</b></p> <p><b>Y : The width of crack.</b>  <b>W : terminal length</b>  <b>a : LCD side length</b></p>	Minor						
		<p>8.1 General glass chip :</p> <p>8.1.1 Chip on panel surface and crack between panels:</p>  <table border="1" data-bbox="542 1545 1340 1836"> <thead> <tr> <th>X</th> <th>Y</th> <th>Z</th> </tr> </thead> <tbody> <tr> <td><math>\leq a</math></td> <td>Crack can't enter viewing area</td> <td><math>\leq 1/2 t</math></td> </tr> <tr> <td><math>\leq a</math></td> <td>Crack can't exceed the half of SP width.</td> <td><math>1/2 t &lt; Z \leq 2 t</math></td> </tr> </tbody> </table>		X	Y	Z	$\leq a$	Crack can't enter viewing area	$\leq 1/2 t$
X	Y	Z							
$\leq a$	Crack can't enter viewing area	$\leq 1/2 t$							
$\leq a$	Crack can't exceed the half of SP width.	$1/2 t < Z \leq 2 t$							

**◆ Specification For TFT-LCD Module 3.5" ~10" :**

(Ver.B01)

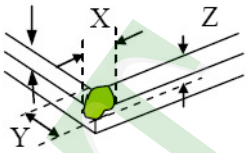
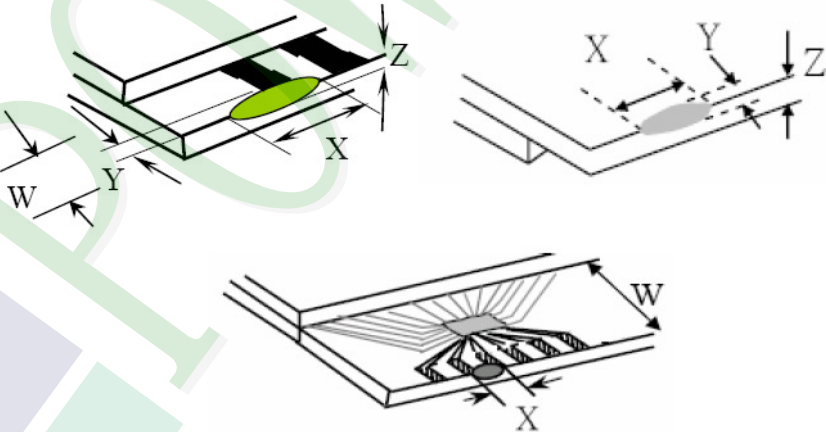
NO	Item	Criterion	Level												
08	The crack of glass	<p><b>Symbols :</b></p> <p><b>X :</b> The length of crack  <b>Z :</b> The thickness of crack  <b>t :</b> The thickness of glass</p> <p><b>Y :</b> The width of crack.  <b>W :</b> terminal length  <b>a :</b> LCD side length</p> <hr/> <p>8.1.2 Corner crack :</p>  <table border="1" data-bbox="525 757 1332 1048"> <thead> <tr> <th>X</th> <th>Y</th> <th>Z</th> </tr> </thead> <tbody> <tr> <td><math>\leq 1/5 a</math></td> <td>Crack can't enter viewing area</td> <td><math>Z \leq 1/2 t</math></td> </tr> <tr> <td><math>\leq 1/5 a</math></td> <td>Crack can't exceed the half of SP width.</td> <td><math>1/2 t &lt; Z \leq 2 t</math></td> </tr> </tbody> </table>	X	Y	Z	$\leq 1/5 a$	Crack can't enter viewing area	$Z \leq 1/2 t$	$\leq 1/5 a$	Crack can't exceed the half of SP width.	$1/2 t < Z \leq 2 t$				
		X	Y	Z											
$\leq 1/5 a$	Crack can't enter viewing area	$Z \leq 1/2 t$													
$\leq 1/5 a$	Crack can't exceed the half of SP width.	$1/2 t < Z \leq 2 t$													
		<p>8.2 Protrusion over terminal :</p> <p>8.2.1 Chip on electrode pad :</p>  <table border="1" data-bbox="563 1680 1343 1848"> <thead> <tr> <th></th> <th>X</th> <th>Y</th> <th>Z</th> </tr> </thead> <tbody> <tr> <td><b>Front</b></td> <td><math>\leq a</math></td> <td><math>\leq 1/2 W</math></td> <td><math>\leq t</math></td> </tr> <tr> <td><b>Back</b></td> <td><math>\leq a</math></td> <td><math>\leq W</math></td> <td><math>\leq 1/2 t</math></td> </tr> </tbody> </table>		X	Y	Z	<b>Front</b>	$\leq a$	$\leq 1/2 W$	$\leq t$	<b>Back</b>	$\leq a$	$\leq W$	$\leq 1/2 t$	Minor
	X	Y	Z												
<b>Front</b>	$\leq a$	$\leq 1/2 W$	$\leq t$												
<b>Back</b>	$\leq a$	$\leq W$	$\leq 1/2 t$												



**◆ Specification For TFT-LCD Module 3.5" ~10" :**

(Ver.B01)

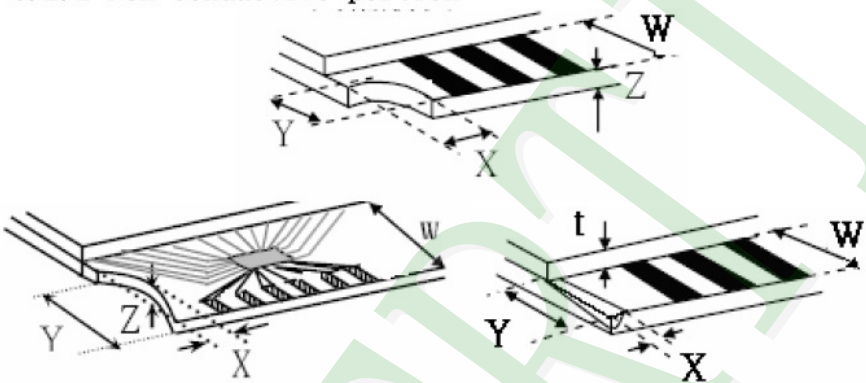
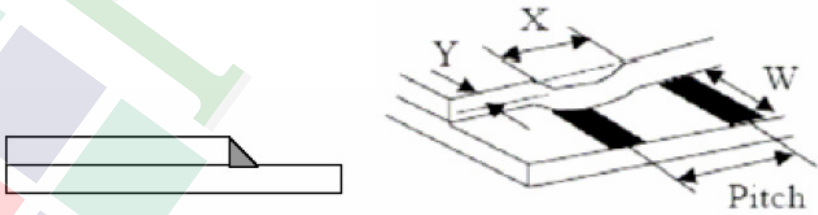
NO	Item	Criterion	Level												
08	The crack of glass	<p><b>Symbols :</b></p> <p><b>X : The length of crack</b>                      <b>Y : The width of crack.</b>  <b>Z : The thickness of crack</b>                <b>W : terminal length</b>  <b>t : The thickness of glass</b>                 <b>a : LCD side length</b></p> <hr/> <p>8.2.2 Non-conductive portion :</p>  <table border="1" data-bbox="630 963 1260 1120"> <thead> <tr> <th>X</th> <th>Y</th> <th>Z</th> </tr> </thead> <tbody> <tr> <td><math>\leq 1/3 a</math></td> <td><math>\leq W</math></td> <td><math>\leq t</math></td> </tr> </tbody> </table> <p>⊙ If the chipped area touches the ITO terminal, over 2/3 of the ITO must remain and be inspected according to electrode terminal specifications.</p> <p>8.2.3 Glass remain :</p>  <table border="1" data-bbox="550 1736 1244 1881"> <thead> <tr> <th>X</th> <th>Y</th> <th>Z</th> </tr> </thead> <tbody> <tr> <td><math>\leq a</math></td> <td><math>\leq 1/3 W</math></td> <td><math>\leq t</math></td> </tr> </tbody> </table>	X	Y	Z	$\leq 1/3 a$	$\leq W$	$\leq t$	X	Y	Z	$\leq a$	$\leq 1/3 W$	$\leq t$	Minor
		X	Y	Z											
$\leq 1/3 a$	$\leq W$	$\leq t$													
X	Y	Z													
$\leq a$	$\leq 1/3 W$	$\leq t$													

**◆Specification For TFT-LCD Module 3.5" ~10" :**

(Ver.B01)

NO	Item	Criterion	Level
09	Backlight elements	9. 1 Backlight can't work normally.	Major
		9. 2 Backlight doesn't light or color is wrong.	Major
		9. 3 Illumination source flickers when lit.	Major
10	General appearance	10. 1 Pin type 、 quantity 、 dimension must match type in structure diagram.	Major
		10. 2 No short circuits in components on PCB or FPC .	Major
		10. 3 Parts on PCB or FPC must be the same as on the production characteristic chart .There should be no wrong parts , missing parts or excess parts.	Major
		10. 4 Product packaging must the same as specified on packaging specification sheet.	Minor
		10. 5 The folding and peeled off in polarizer are not acceptable.	Minor
		10. 6 The PCB or FPC between B/L assembled distance(PCB or FPC ) is $\leq 1.5$ mm.	Minor

## 4. RELIABILITY TEST

### 4.1 Reliability Test Condition

(Ver.B01)

NO.	TEST ITEM	TEST CONDITION										
1	High Temperature Storage Test	Keep in <b>+80 ±2°C</b> 96 hrs Surrounding temperature, then storage at normal condition 4hrs.										
2	Low Temperature Storage Test	Keep in <b>-30 ±2°C</b> 96 hrs Surrounding temperature, then storage at normal condition 4hrs.										
3	High Temperature / High Humidity Storage Test	Keep in <b>+60 °C / 90% R.H</b> duration for 96 hrs Surrounding temperature, then storage at normal condition 4hrs. (Excluding the polarizer)										
4	Temperature Cycling Storage Test	<p style="text-align: center;"> <math>-30^{\circ}\text{C} \rightarrow +25^{\circ}\text{C} \rightarrow +80^{\circ}\text{C} \rightarrow +25^{\circ}\text{C}</math>            (30mins) (5mins) (30mins) (5mins)  <math>\leftarrow \hspace{15em} \rightarrow</math>  <b>10 Cycle</b> </p> Surrounding temperature, then storage at normal condition 4hrs.										
5	ESD Test	Air Discharge: Apply <b>2 KV</b> with 5 times Discharge for each polarity +/-										
		Contact Discharge: Apply <b>250 V</b> with 5 times discharge for each polarity +/-										
		1. Temperature ambience : <b>15°C ~ 35°C</b> 2. Humidity relative : <b>30% ~ 60%</b> 3. Energy Storage Capacitance(Cs+Cd) : <b>150pF±10%</b> 4. Discharge Resistance(Rd) : <b>330Ω±10%</b> 5. Discharge, mode of operation : Single Discharge (time between successive discharges at least 1 sec) (Tolerance if the output voltage indication : <b>±5%</b> )										
6	Vibration Test (Packaged)	1. Sine wave <b>10~55 Hz</b> frequency (1 min/sweep) 2. The amplitude of vibration : <b>1.5 mm</b> 3. Each direction (X、Y、Z) duration for <b>2 Hrs</b>										
7	Drop Test (Packaged)	<table border="1" style="width: 100%; text-align: center;"> <thead> <tr> <th>Packing Weight (Kg)</th> <th>Drop Height (cm)</th> </tr> </thead> <tbody> <tr> <td>0 ~ 45.4</td> <td>122</td> </tr> <tr> <td>45.4 ~ 90.8</td> <td>76</td> </tr> <tr> <td>90.8 ~ 454</td> <td>61</td> </tr> <tr> <td>Over 454</td> <td>46</td> </tr> </tbody> </table>	Packing Weight (Kg)	Drop Height (cm)	0 ~ 45.4	122	45.4 ~ 90.8	76	90.8 ~ 454	61	Over 454	46
		Packing Weight (Kg)	Drop Height (cm)									
0 ~ 45.4	122											
45.4 ~ 90.8	76											
90.8 ~ 454	61											
Over 454	46											
	Drop Direction : ※1 corner / 3 edges / 6 sides each 1time											

## 5. PRECAUTION RELATING PRODUCT HANDLING

### 5.1 SAFETY

- 5.1.1 If the LCD panel breaks , be careful not to get the liquid crystal to touch your skin.
- 5.1.2 If the liquid crystal touches your skin or clothes , please wash it off immediately by using soap and water.

### 5.2 HANDLING

- 5.2.1 Avoid any strong mechanical shock which can break the glass.
- 5.2.2 Avoid static electricity which can damage the CMOS LSI—When working with the module , be sure to ground your body and any electrical equipment you may be using.
- 5.2.3 Do not remove the panel or frame from the module.
- 5.2.4 The polarizing plate of the display is very fragile. So , please handle it very carefully ,do not touch , push or rub the exposed polarizing with anything harder than an HB pencil lead (glass , tweezers , etc.)
- 5.2.5 Do not wipe the polarizing plate with a dry cloth , as it may easily scratch the surface of plate.
- 5.2.6 Do not touch the display area with bare hands , this will stain the display area.
- 5.2.7 Do not use ketonics solvent & aromatic solvent. Use with a soft cloth soaked with a cleaning naphtha solvent.
- 5.2.8 To control temperature and time of soldering is  $320\pm 10^{\circ}\text{C}$  and 3-5 sec.
- 5.2.9 To avoid liquid (include organic solvent) stained on LCM .

### 5.3 STORAGE

- 5.3.1 Store the panel or module in a dark place where the temperature is  $25^{\circ}\text{C} \pm 5^{\circ}\text{C}$  and the humidity is below 65% RH.
- 5.3.2 Do not place the module near organics solvents or corrosive gases.
- 5.3.3 Do not crush , shake , or jolt the module.

### 5.4 TERMS OF WARRANTY

- 5.4.1 Applicable warrant period  
The period is within thirteen months since the date of shipping out under normal using and storage conditions.
- 5.4.2 Unaccepted responsibility  
This product has been manufactured to your company's specification as a part for use in your company's general electronic products. It is guaranteed to perform according to delivery specifications. For any other use apart from general electronic equipment , we cannot take responsibility if the product is used in nuclear power control equipment , aerospace equipment , fire and security systems or any other applications in which there is a direct risk to human life and where extremely high levels of reliability are required.

久正光電股份有限公司  
POWER TIP TECHNOLOGY CORPORATION

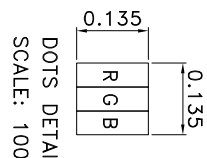
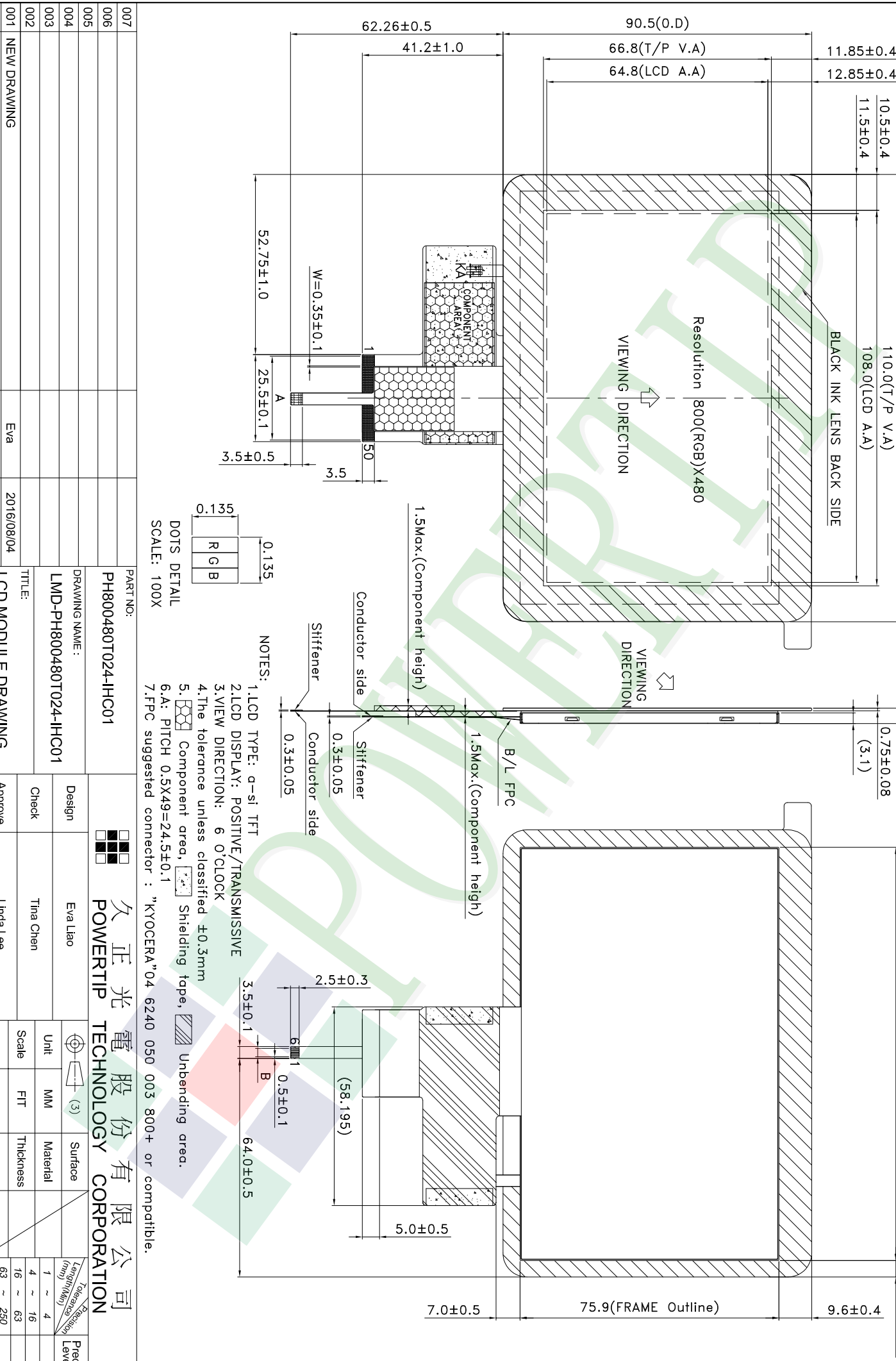

- NOTES:**
- LCD TYPE: a-si TFT
  - LCD DISPLAY: POSITIVE/TRANSMISSIVE
  - VIEW DIRECTION: 6 O'CLOCK
  - The tolerance unless classified ±0.3mm
  - Component area, Shielding tape, Unbending area.
  - PITCH 0.5X49=24.5±0.1
  - FPC suggested connector: "KYOCERA" 04 6240 050 003 800+ or compatible.

REV	REV BY	REVISER	DATE	TITLE	DESIGN	CHECK	APPROVE	UNIT	SCALE	PAGE	THICKNESS	PRECISION LEVEL
007												
006												
005												
004												
003												
002												
001	NEW DRAWING	Eva	2016/08/04	LCD MODULE DRAWING	Design	Check	Approve	MM	FIT	1/1		

PT-A-054-01