

LP38853 3A Fast-Response High-Accuracy Adjustable LDO Linear Regulator with Enable and Soft-Start

Check for Samples: [LP38853](#)

FEATURES

- Adjustable V_{OUT} Range of 0.80V to 1.8V
- Wide V_{BIAS} Supply Operating Range of 3.0V to 5.5V
- Stable with 10 μ F Ceramic Capacitors
- Dropout Voltage of 240 mV (typical) at 3A Load Current
- Precision V_{ADJ} Across All Line and Load Conditions:
 - $\pm 1.5\%$ V_{ADJ} for $T_J = 25^\circ\text{C}$
 - $\pm 2.0\%$ V_{ADJ} for $0^\circ\text{C} \leq T_J \leq +125^\circ\text{C}$
 - $\pm 3.0\%$ V_{ADJ} for $-40^\circ\text{C} \leq T_J \leq +125^\circ\text{C}$
- Over-Temperature and Over-Current Protection
- Available in 8 Lead SO PowerPAD, 7 Lead PFM and 7 Lead DDPACK Packages
- -40°C to $+125^\circ\text{C}$ Operating Junction Temperature Range

APPLICATIONS

- ASIC Power Supplies in:
 - Desktops, Notebooks, and Graphics Cards, Servers
 - Gaming Set Top Boxes, Printers and Copiers
- Server Core and I/O Supplies
- DSP and FPGA Power Supplies
- SMPS Post-Regulator

DESCRIPTION

The LP38853-ADJ is a high current, fast response regulator which can maintain output voltage regulation with extremely low input to output voltage drop. Fabricated on a CMOS process, the device operates from two input voltages: V_{BIAS} provides voltage to drive the gate of the N-MOS power transistor, while V_{IN} is the input voltage which supplies power to the load. The use of an external bias rail allows the part to operate from ultra low V_{IN} voltages. Unlike bipolar regulators, the CMOS architecture consumes extremely low quiescent current at any output load current. The use of an N-MOS power transistor results in wide bandwidth, yet minimum external capacitance is required to maintain loop stability.

The fast transient response of this device makes it suitable for use in powering DSP, Microcontroller Core voltages and Switch Mode Power Supply post regulators. The part is available in SO PowerPAD 8-pin, PFM 7-pin, and DDPACK 7-pin packages.

Dropout Voltage: 240 mV (typical) at 3A load current.

Low Ground Pin Current: 10 mA (typical) at 3A load current.

Soft-Start: Programmable Soft-Start time.

Precision ADJ Voltage: $\pm 1.5\%$ for $T_J = 25^\circ\text{C}$, and $\pm 2.0\%$ for $0^\circ\text{C} \leq T_J \leq +125^\circ\text{C}$, across all line and load conditions



Please be aware that an important notice concerning availability, standard warranty, and use in critical applications of Texas Instruments semiconductor products and disclaimers thereto appears at the end of this data sheet.

All trademarks are the property of their respective owners.

Typical Application Circuit

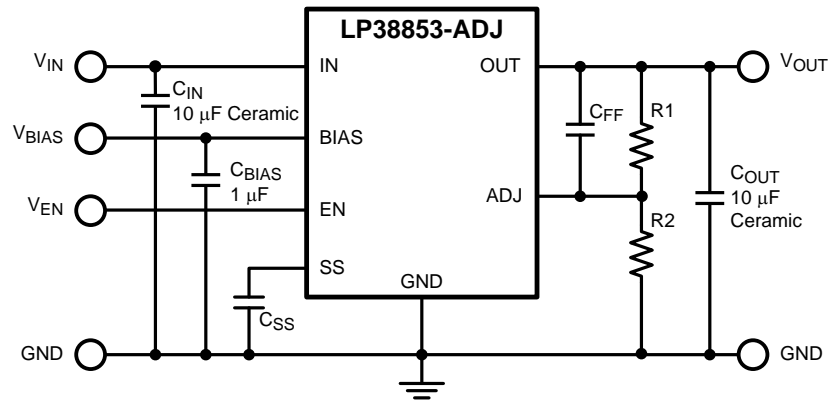

Connection Diagram

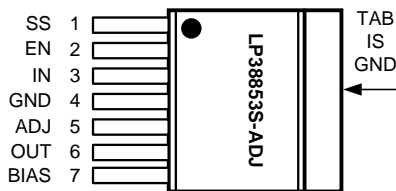

Figure 1. DPAK-7 – Top View
See Package Number KTW0007B

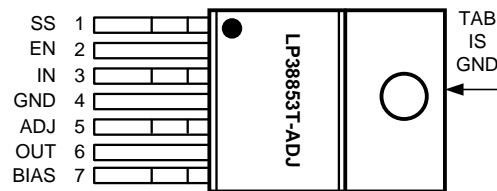

Figure 2. PFM – Top View
See Package Number NDZ0007B

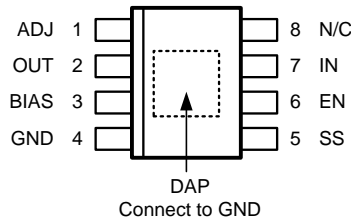

Figure 3. SO PowerPAD-8 – Top View
See Package Number DDA0008A

PIN DESCRIPTIONS

PFM-7 Pin #	DDPAK-7 Pin #	SO PowerPAD-8 Pin #	Pin Symbol	Pin Description
1	1	5	SS	Soft-Start capacitor connection. Used to control the rise time of V_{OUT} at turn-on.
2	2	6	EN	Device Enable, High = On, Low = Off.
3	3	7	IN	The unregulated voltage input
4	4	4	GND	Ground
5	5	1	ADJ	The feedback connection to set the output voltage
6	6	2	OUT	The regulated output voltage
7	7	3	BIAS	The supply for the internal control and reference circuitry.
-	-	8	N/C	No internal connection
TAB	TAB	-	TAB	The PFM and DPAK TAB is a thermal and electrical connection that is physically attached to the backside of the die, and used as a thermal heat-sink connection. See the Application Information section for details.

PIN DESCRIPTIONS (continued)

PFM-7 Pin #	DDPAK-7 Pin #	SO PowerPAD- 8 Pin #	Pin Symbol	Pin Description
-	-	DAP	DAP	The SO PowerPAD DAP is a thermal connection only that is physically attached to the backside of the die, and used as a thermal heat-sink connection. See the Application Information section for details.



These devices have limited built-in ESD protection. The leads should be shorted together or the device placed in conductive foam during storage or handling to prevent electrostatic damage to the MOS gates.

Absolute Maximum Ratings⁽¹⁾⁽²⁾

Storage Temperature Range	-65°C to +150°C
Lead Temperature Soldering, 5 seconds	260°C
ESD Rating	Human Body Model ⁽³⁾ ±2 kV
Power Dissipation ⁽⁴⁾	Internally Limited
V _{IN} Supply Voltage (Survival)	-0.3V to +6.0V
V _{BIAS} Supply Voltage (Survival)	-0.3V to +6.0V
V _{SS} SoftStart Voltage (Survival)	-0.3V to +6.0V
V _{OUT} Voltage (Survival)	-0.3V to +6.0V
I _{OUT} Current (Survival)	Internally Limited
Junction Temperature	-40°C to +150°C

- (1) Absolute Maximum Ratings indicate limits beyond which damage to the device may occur. Operating Ratings indicate conditions for which the device is intended to be functional, but does not ensure specific performance limits. For ensured specifications and conditions, see the Electrical Characteristics.
- (2) If Military/Aerospace specified devices are required, please contact the TI Sales Office/ Distributors for availability and specifications.
- (3) The human body model is a 100 pF capacitor discharged through a 1.5k resistor into each pin. Test method is per JESD22-A114.
- (4) Device power dissipation must be de-rated based on device power dissipation (P_D), ambient temperature (T_A), and package junction to ambient thermal resistance (θ_{JA}). Additional heat-sinking may be required to ensure that the device junction temperature (T_J) does not exceed the maximum operating rating. See the [Application Information](#) section for details.

Operating Ratings⁽¹⁾

V _{IN} Supply Voltage	(V _{OUT} + V _{DO}) to V _{BIAS}	
V _{BIAS} Supply Voltage	0.8V ≤ V _{OUT} ≤ 1.2V	3.0V to 5.5V
	1.2V < V _{OUT} ≤ 1.8V	4.5V to 5.5V
V _{EN} Voltage	0.0V to V _{BIAS}	
I _{OUT}	0 mA to 3.0A	
Junction Temperature Range ⁽²⁾	-40°C to +125°C	

- (1) Absolute Maximum Ratings indicate limits beyond which damage to the device may occur. Operating Ratings indicate conditions for which the device is intended to be functional, but does not ensure specific performance limits. For ensured specifications and conditions, see the Electrical Characteristics.
- (2) Device power dissipation must be de-rated based on device power dissipation (P_D), ambient temperature (T_A), and package junction to ambient thermal resistance (θ_{JA}). Additional heat-sinking may be required to ensure that the device junction temperature (T_J) does not exceed the maximum operating rating. See the [Application Information](#) section for details.

Electrical Characteristics

Unless otherwise specified: $V_{OUT} = 0.80V$, $V_{IN} = V_{OUT(NOM)} + 1V$, $V_{BIAS} = 3.0V$, $V_{EN} = V_{BIAS}$, $I_{OUT} = 10\text{ mA}$, $C_{IN} = C_{OUT} = 10\text{ }\mu\text{F}$, $C_{BIAS} = 1\text{ }\mu\text{F}$, $C_{SS} = \text{open}$. Limits in standard type are for $T_J = 25^\circ\text{C}$ only; limits in **boldface type** apply over the junction temperature (T_J) range of -40°C to $+125^\circ\text{C}$. Minimum and Maximum limits are specified through test, design, or statistical correlation. Typical values represent the most likely parametric norm at $T_J = 25^\circ\text{C}$, and are provided for reference purposes only.

Symbol	Parameter	Conditions	Min	Typ	Max	Units
V_{ADJ}	V_{ADJ} Accuracy	$V_{OUT(NOM)}+1V \leq V_{IN} \leq V_{BIAS} \leq 4.5V$, ⁽¹⁾ $3.0V \leq V_{BIAS} \leq 5.5V$, $10\text{ mA} \leq I_{OUT} \leq 3A$	492.5 485.0	500.	507.5 515.0	mV
		$V_{OUT(NOM)}+1V \leq V_{IN} \leq V_{BIAS} \leq 4.5V$, ⁽¹⁾ $3.0V \leq V_{BIAS} \leq 5.5V$, $10\text{ mA} \leq I_{OUT} \leq 3.0A$, $0^\circ\text{C} \leq T_J \leq +125^\circ\text{C}$	490.0	500.	510.0	
V_{OUT}	V_{OUT} Range	$3.0V \leq V_{BIAS} \leq 5.5V$	0.80		1.20	V
		$4.5V \leq V_{BIAS} \leq 5.5V$	0.80		1.80	
$\Delta V_{OUT}/\Delta V_{IN}$	Line Regulation, V_{IN} ⁽²⁾	$V_{OUT(NOM)}+1V \leq V_{IN} \leq V_{BIAS}$	-	0.04	-	%/V
$\Delta V_{OUT}/\Delta V_{BIAS}$	Line Regulation, V_{BIAS} ⁽²⁾	$3.0V \leq V_{BIAS} \leq 5.5V$	-	0.10	-	%/V
$\Delta V_{OUT}/\Delta I_{OUT}$	Output Voltage Load Regulation ⁽³⁾	$10\text{ mA} \leq I_{OUT} \leq 3.0A$	-	0.2	-	%/A
V_{DO}	Dropout Voltage ⁽⁴⁾	$I_{OUT} = 3.0A$	-	240	300 450	mV
$I_{GND(IN)}$	Quiescent Current Drawn from V_{IN} Supply	$V_{OUT} = 0.80V$ $V_{BIAS} = 3.0V$ $10\text{ mA} \leq I_{OUT} \leq 3.0A$	-	7.0	8.5 9.0	mA
		$V_{EN} \leq 0.5V$		1	10 300	μA
$I_{GND(BIAS)}$	Quiescent Current Drawn from V_{BIAS} Supply	$10\text{ mA} \leq I_{OUT} \leq 3.0A$	-	3.0	3.8 4.5	mA
		$V_{EN} \leq 0.5V$		100	170 200	μA
UVLO	Under-Voltage Lock-Out Threshold	V_{BIAS} rising until device is functional	2.20 2.00	2.45	2.70 2.90	V
UVLO(HYS)	Under-Voltage Lock-Out Hysteresis	V_{BIAS} falling from UVLO threshold until device is non-functional	60 50	150	300 350	mV
I_{SC}	Output Short-Circuit Current	$V_{IN} = V_{OUT(NOM)} + 1V$, $V_{BIAS} = 3.0V$, $V_{OUT} = 0.0V$	-	5.8	-	A
Soft-Start						
r_{SS}	Soft-Start internal resistance		11.0	13.5	16.0	k Ω
t_{SS}	Soft-Start time $t_{SS} = C_{SS} \times r_{SS} \times 5$	$C_{SS} = 10\text{ nF}$	-	675	-	μs
Enable						
I_{EN}	ENABLE pin Current	$V_{EN} = V_{BIAS}$	-	0.01	-	μA
		$V_{EN} = 0.0V$, $V_{BIAS} = 5.5V$	-19 -13	-30	-40 -51	
$V_{EN(ON)}$	Enable Voltage Threshold	V_{EN} rising until Output = ON	1.00 0.90	1.25	1.50 1.55	V
$V_{EN(HYS)}$	Enable Voltage Hysteresis	V_{EN} falling from $V_{EN(ON)}$ until Output = OFF	50 30	100	150 200	mV
t_{OFF}	Turn-OFF Delay Time	$R_{LOAD} \times C_{OUT} \ll t_{OFF}$	-	20	-	μs
t_{ON}	Turn-ON Delay Time	$R_{LOAD} \times C_{OUT} \ll t_{ON}$	-	15	-	

- V_{IN} cannot exceed either V_{BIAS} or 4.5V, whichever value is lower.
- Output voltage line regulation is defined as the change in output voltage from nominal value resulting from a change in input voltage.
- Output voltage load regulation is defined as the change in output voltage from nominal value as the load current increases from no load to full load.
- Dropout voltage is defined as the input to output voltage differential ($V_{IN} - V_{OUT}$) where the input voltage is low enough to cause the output voltage to drop 2% from the nominal value.

Electrical Characteristics (continued)

Unless otherwise specified: $V_{OUT} = 0.80V$, $V_{IN} = V_{OUT(NOM)} + 1V$, $V_{BIAS} = 3.0V$, $V_{EN} = V_{BIAS}$, $I_{OUT} = 10\text{ mA}$, $C_{IN} = C_{OUT} = 10\text{ }\mu\text{F}$, $C_{BIAS} = 1\text{ }\mu\text{F}$, $C_{SS} = \text{open}$. Limits in standard type are for $T_J = 25^\circ\text{C}$ only; limits in **boldface type** apply over the junction temperature (T_J) range of -40°C to $+125^\circ\text{C}$. Minimum and Maximum limits are specified through test, design, or statistical correlation. Typical values represent the most likely parametric norm at $T_J = 25^\circ\text{C}$, and are provided for reference purposes only.

Symbol	Parameter	Conditions	Min	Typ	Max	Units
AC Parameters						
PSRR (V_{IN})	Ripple Rejection for V_{IN} Input Voltage	$V_{IN} = V_{OUT(NOM)} + 1V$, $f = 120\text{ Hz}$	-	80	-	dB
		$V_{IN} = V_{OUT(NOM)} + 1V$, $f = 1\text{ kHz}$	-	70	-	
PSRR (V_{BIAS})	Ripple Rejection for V_{BIAS} Voltage	$V_{BIAS} = V_{OUT(NOM)} + 3V$, $f = 120\text{ Hz}$	-	58	-	
		$V_{BIAS} = V_{OUT(NOM)} + 3V$, $f = 1\text{ kHz}$	-	58	-	
e_n	Output Noise Density	$f = 120\text{ Hz}$	-	1	-	$\mu\text{V}/\sqrt{\text{Hz}}$
	Output Noise Voltage	$\text{BW} = 10\text{ Hz} - 100\text{ kHz}$	-	150	-	μV_{RMS}
		$\text{BW} = 300\text{ Hz} - 300\text{ kHz}$	-	90	-	
Thermal Parameters						
T_{SD}	Thermal Shutdown Junction Temperature		-	160	-	$^\circ\text{C}$
$T_{SD(HYS)}$	Thermal Shutdown Hysteresis		-	10	-	
θ_{J-A}	Thermal Resistance, Junction to Ambient ⁽⁵⁾	PFM	-	60	-	$^\circ\text{C}/\text{W}$
		DDPAK-7	-	60	-	
		SO PowerPAD-8	-	168	-	
θ_{J-C}	Thermal Resistance, Junction to Case ⁽⁵⁾ ⁽⁶⁾	PFM-7	-	3	-	
		DDPAK-7	-	3	-	
		SO PowerPAD-8	-	11	-	

- (5) Device power dissipation must be de-rated based on device power dissipation (P_D), ambient temperature (T_A), and package junction to ambient thermal resistance (θ_{J-A}). Additional heat-sinking may be required to ensure that the device junction temperature (T_J) does not exceed the maximum operating rating. See the [Application Information](#) section for details.
- (6) For PFM and DDPAK: θ_{J-C} refers to the BOTTOM surface of the package, under the epoxy body, as the 'CASE'. For SO PowerPAD-8: θ_{J-C} refers to the DAP (aka: Exposed Pad) on BOTTOM surface of the package as the 'CASE'.

Typical Performance Characteristics

Refer to the [Typical Application Circuit](#). Unless otherwise specified: $T_J = 25^\circ\text{C}$, $R_1 = 1.40\text{ k}\Omega$, $R_2 = 1.00\text{ k}\Omega$, $C_{FF} = 0.01\text{ }\mu\text{F}$, $V_{IN} = V_{OUT(NOM)} + 1\text{V}$, $V_{BIAS} = 3.0\text{V}$, $I_{OUT} = 10\text{ mA}$, $C_{IN} = 10\text{ }\mu\text{F}$ Ceramic, $C_{OUT} = 10\text{ }\mu\text{F}$ Ceramic, $C_{BIAS} = 1\text{ }\mu\text{F}$ Ceramic, $C_{SS} = \text{Open}$.

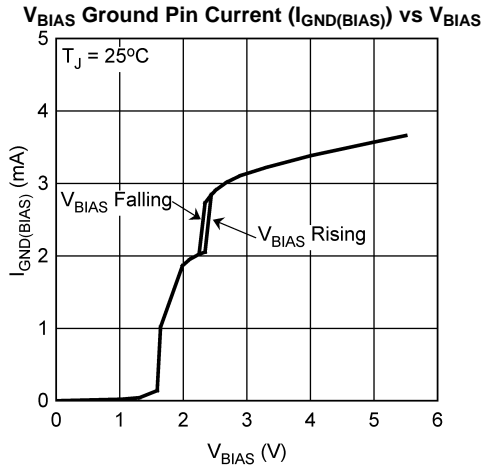

Figure 4.

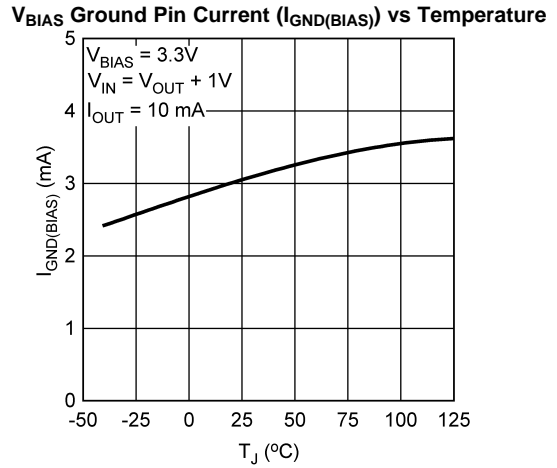

Figure 5.

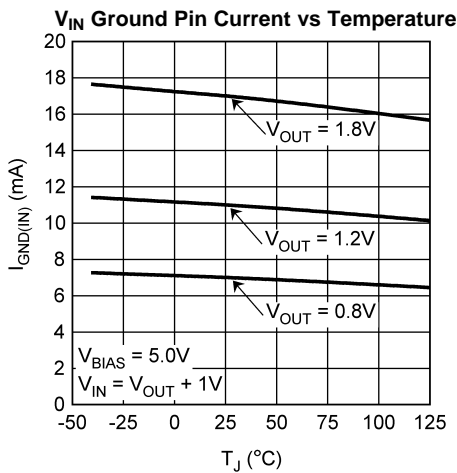

Figure 6.

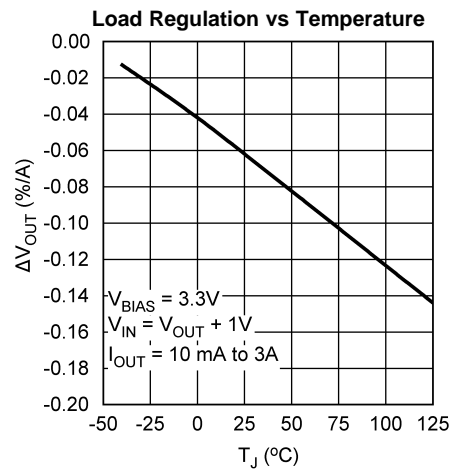

Figure 7.

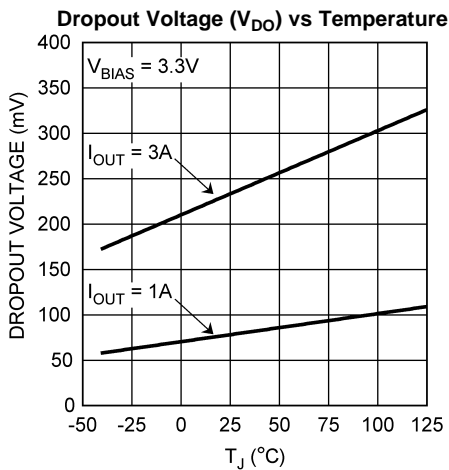

Figure 8.

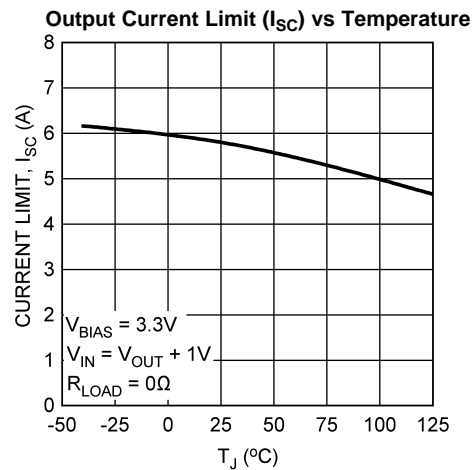

Figure 9.

Typical Performance Characteristics (continued)

Refer to the [Typical Application Circuit](#). Unless otherwise specified: $T_J = 25^\circ\text{C}$, $R_1 = 1.40\text{ k}\Omega$, $R_2 = 1.00\text{ k}\Omega$, $C_{FF} = 0.01\text{ }\mu\text{F}$, $V_{IN} = V_{OUT(NOM)} + 1\text{V}$, $V_{BIAS} = 3.0\text{V}$, $I_{OUT} = 10\text{ mA}$, $C_{IN} = 10\text{ }\mu\text{F Ceramic}$, $C_{OUT} = 10\text{ }\mu\text{F Ceramic}$, $C_{BIAS} = 1\text{ }\mu\text{F Ceramic}$, $C_{SS} = \text{Open}$.

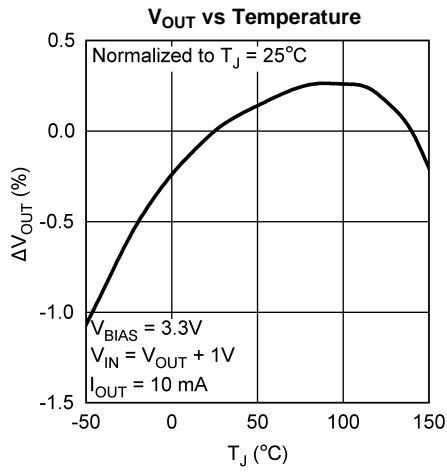

Figure 10.

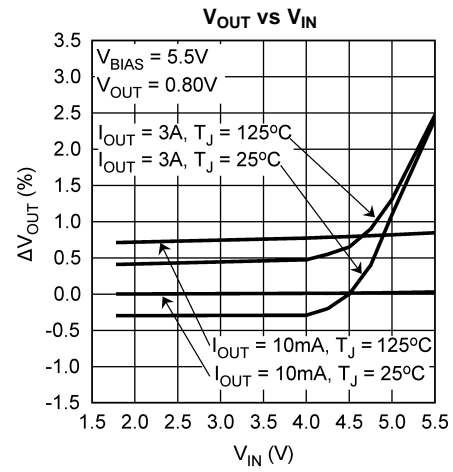

Figure 11.

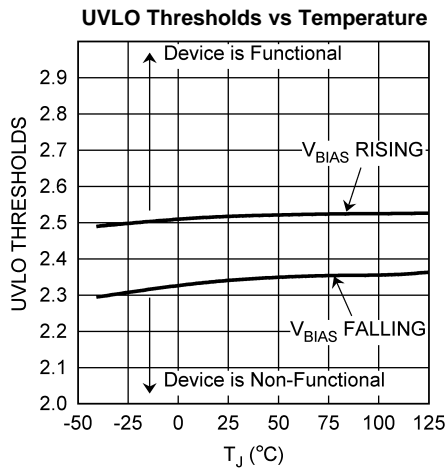

Figure 12.

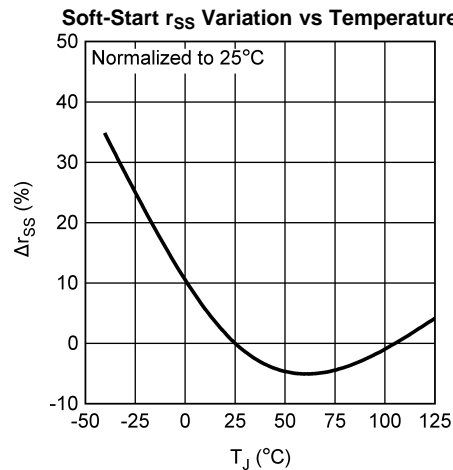

Figure 13.

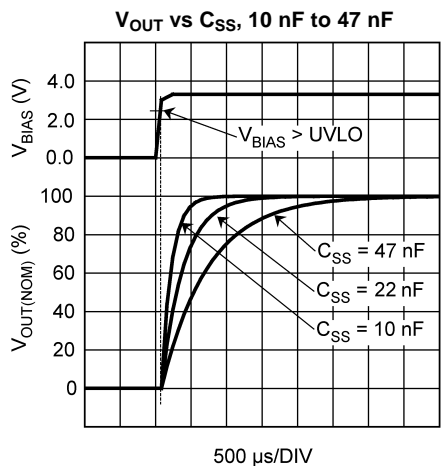

Figure 14.

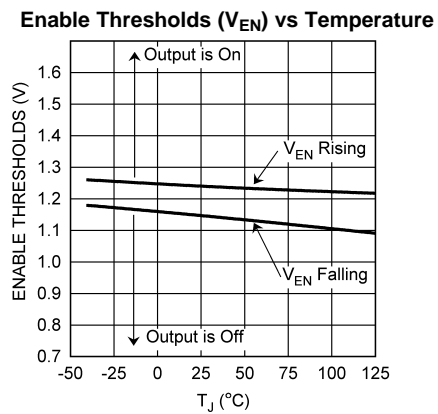

Figure 15.

Typical Performance Characteristics (continued)

Refer to the [Typical Application Circuit](#). Unless otherwise specified: $T_J = 25^\circ\text{C}$, $R_1 = 1.40\text{ k}\Omega$, $R_2 = 1.00\text{ k}\Omega$, $C_{FF} = 0.01\text{ }\mu\text{F}$, $V_{IN} = V_{OUT(NOM)} + 1\text{V}$, $V_{BIAS} = 3.0\text{V}$, $I_{OUT} = 10\text{ mA}$, $C_{IN} = 10\text{ }\mu\text{F}$ Ceramic, $C_{OUT} = 10\text{ }\mu\text{F}$ Ceramic, $C_{BIAS} = 1\text{ }\mu\text{F}$ Ceramic, $C_{SS} = \text{Open}$.

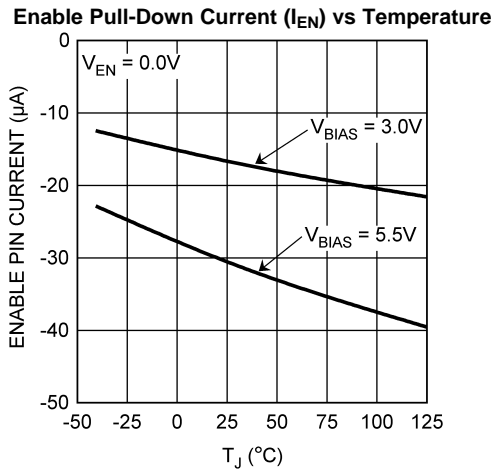

Figure 16.

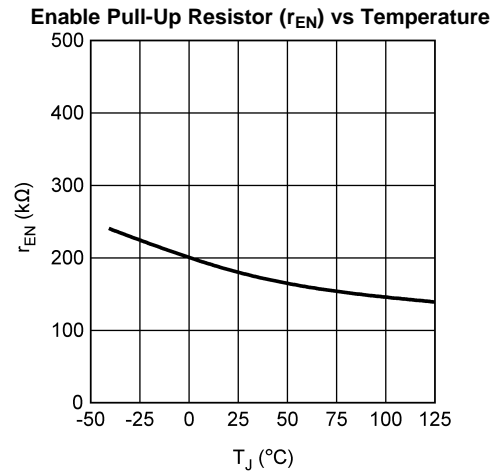

Figure 17.

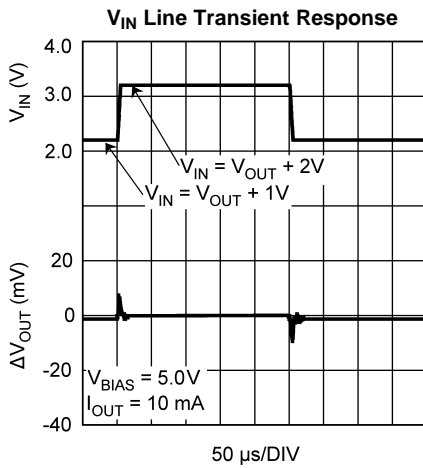

Figure 18.

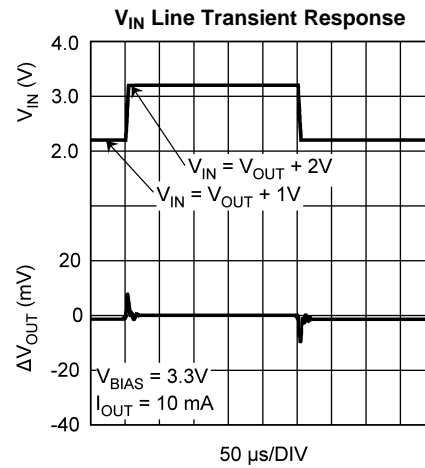

Figure 19.

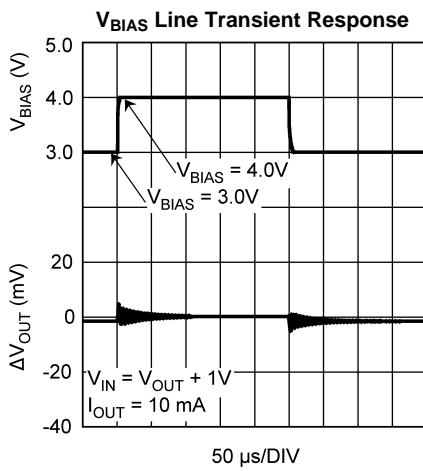

Figure 20.

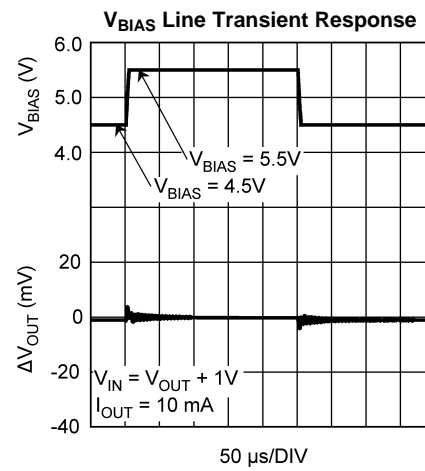
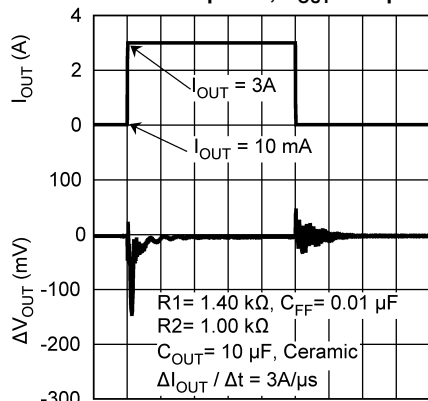

Figure 21.

Typical Performance Characteristics (continued)

Refer to the [Typical Application Circuit](#). Unless otherwise specified: $T_J = 25^\circ\text{C}$, $R_1 = 1.40\text{ k}\Omega$, $R_2 = 1.00\text{ k}\Omega$, $C_{FF} = 0.01\text{ }\mu\text{F}$, $V_{IN} = V_{OUT(NOM)} + 1\text{V}$, $V_{BIAS} = 3.0\text{V}$, $I_{OUT} = 10\text{ mA}$, $C_{IN} = 10\text{ }\mu\text{F}$ Ceramic, $C_{OUT} = 10\text{ }\mu\text{F}$ Ceramic, $C_{BIAS} = 1\text{ }\mu\text{F}$ Ceramic, $C_{SS} = \text{Open}$.

Load Transient Response, $C_{OUT} = 10\text{ }\mu\text{F}$ Ceramic



50 $\mu\text{s}/\text{DIV}$
Figure 22.

Load Transient Response, $C_{OUT} = 10\text{ }\mu\text{F}$ Ceramic

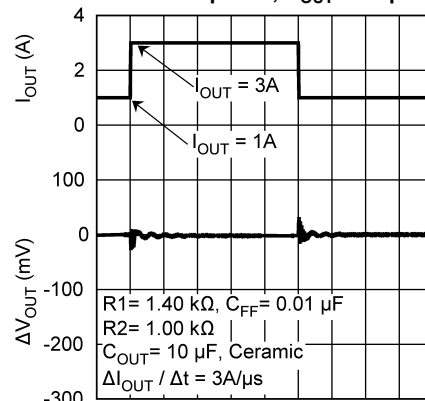

50 $\mu\text{s}/\text{DIV}$
Figure 23.

Load Transient Response, $C_{OUT} = 100\text{ }\mu\text{F}$ Ceramic

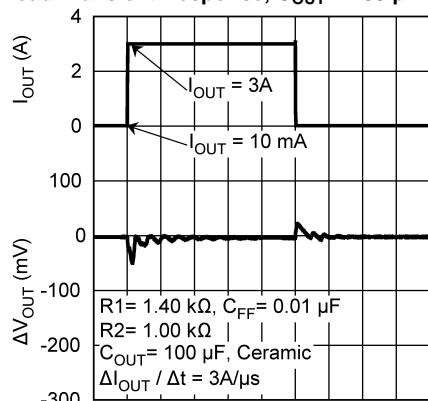

50 $\mu\text{s}/\text{DIV}$
Figure 24.

Load Transient Response, $C_{OUT} = 100\text{ }\mu\text{F}$ Ceramic

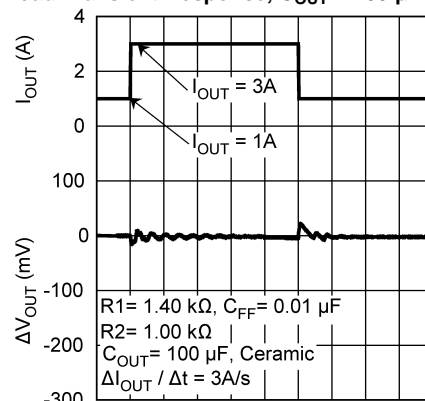

50 $\mu\text{s}/\text{DIV}$
Figure 25.

Load Transient Response, $C_{OUT} = 100\text{ }\mu\text{F}$ Tantalum

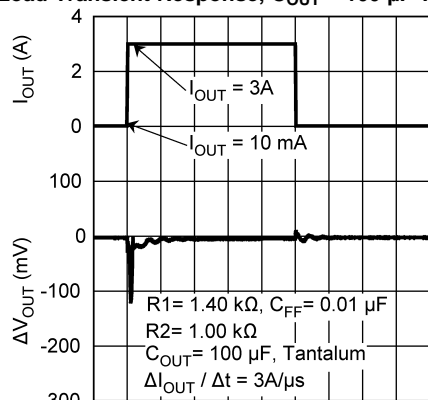

50 $\mu\text{s}/\text{DIV}$
Figure 26.

Load Transient Response, $C_{OUT} = 100\text{ }\mu\text{F}$ Tantalum

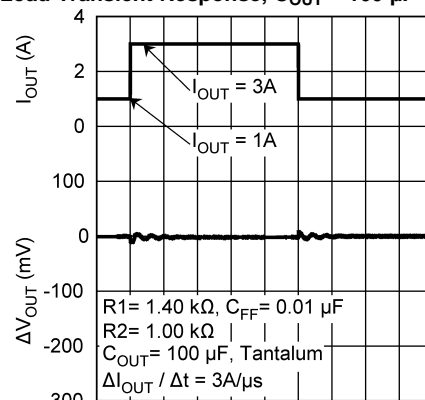

50 $\mu\text{s}/\text{DIV}$
Figure 27.

Typical Performance Characteristics (continued)

Refer to the [Typical Application Circuit](#). Unless otherwise specified: $T_J = 25^\circ\text{C}$, $R_1 = 1.40\text{ k}\Omega$, $R_2 = 1.00\text{ k}\Omega$, $C_{FF} = 0.01\text{ }\mu\text{F}$, $V_{IN} = V_{OUT(NOM)} + 1\text{V}$, $V_{BIAS} = 3.0\text{V}$, $I_{OUT} = 10\text{ mA}$, $C_{IN} = 10\text{ }\mu\text{F Ceramic}$, $C_{OUT} = 10\text{ }\mu\text{F Ceramic}$, $C_{BIAS} = 1\text{ }\mu\text{F Ceramic}$, $C_{SS} = \text{Open}$.

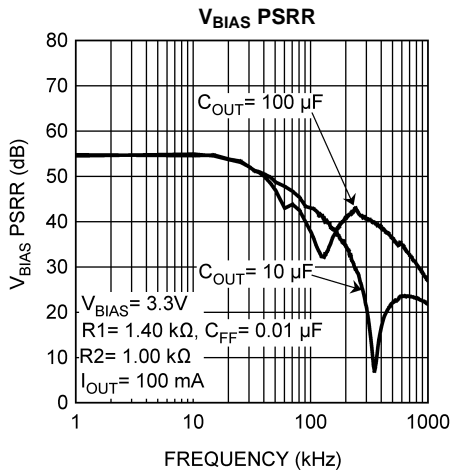

Figure 28.

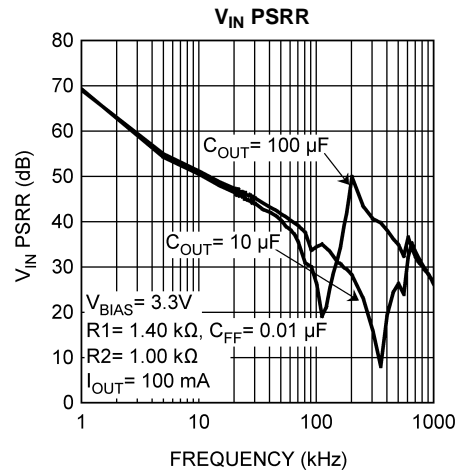

Figure 29.

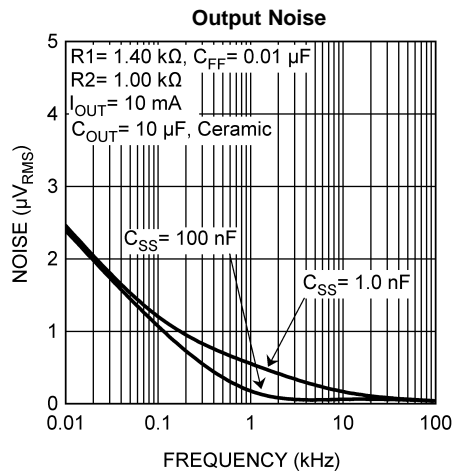
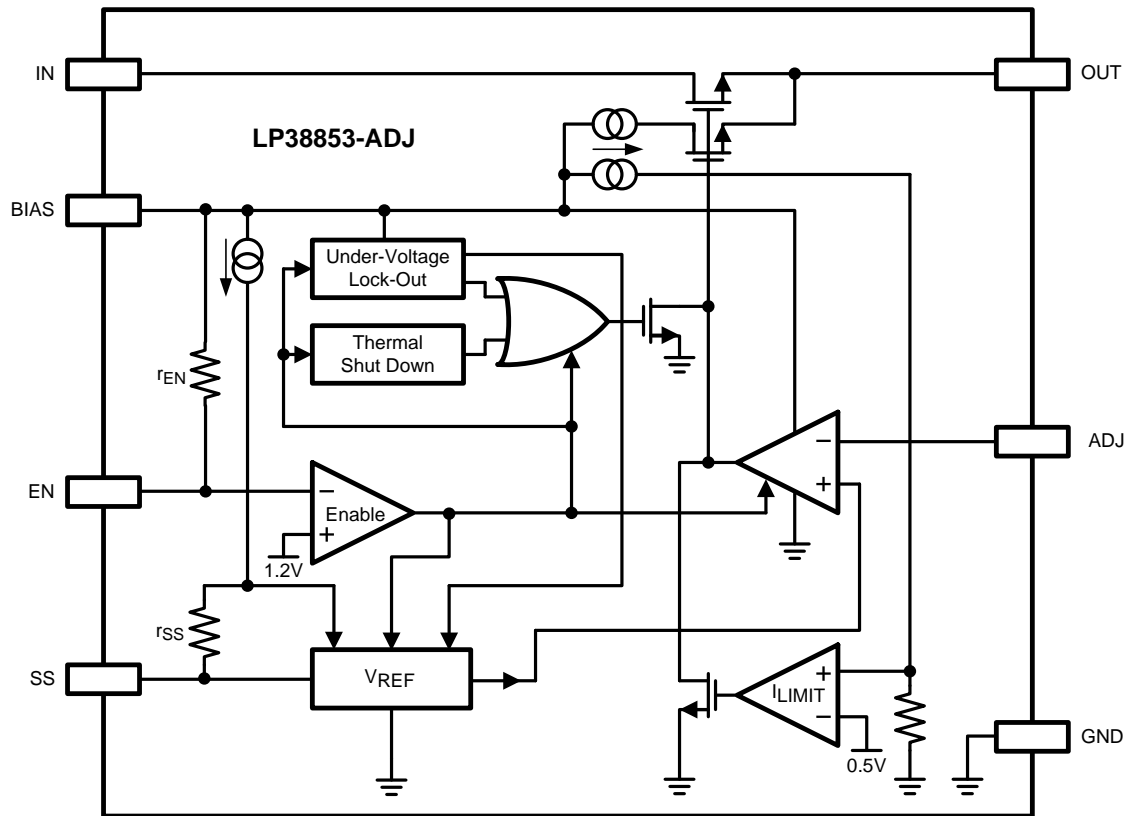

Figure 30.

Block Diagram



APPLICATION INFORMATION

EXTERNAL CAPACITORS

To assure regulator stability, input and output capacitors are required as shown in the [Typical Application Circuit](#).

Output Capacitor

A minimum output capacitance of 10 μF , ceramic, is required for stability. The amount of output capacitance can be increased without limit. The output capacitor must be located less than 1 cm from the output pin of the IC and returned to the device ground pin with a clean analog ground.

Only high quality ceramic types such as X5R or X7R should be used, as the Z5U and Y5F types do not provide sufficient capacitance over temperature.

Tantalum capacitors will also provide stable operation across the entire operating temperature range. However, the effects of ESR may provide variations in the output voltage during fast load transients. Using the minimum recommended 10 μF ceramic capacitor at the output will allow unlimited capacitance, Tantalum and/or Aluminum, to be added in parallel.

Input Capacitor

The input capacitor must be at least 10 μF , but can be increased without limit. Its purpose is to provide a low source impedance for the regulator input. A ceramic capacitor, X5R or X7R, is recommended.

Tantalum capacitors may also be used at the input pin. There is no specific ESR limitation on the input capacitor (the lower, the better).

Aluminum electrolytic capacitors can be used, but are not recommended as their ESR increases very quickly at cold temperatures. They are not recommended for any application where the ambient temperature falls below 0°C.

Bias Capacitor

The capacitor on the bias pin must be at least 1 μF , and can be any good quality capacitor (ceramic is recommended).

Feed Forward Capacitor, C_{FF}

(Refer to the [Typical Application Circuit](#))

When using a ceramic capacitor for C_{OUT} , the typical ESR value will be too small to provide any meaningful positive phase compensation, F_Z , to offset the internal negative phase shifts in the gain loop.

$$F_Z = (1 / (2 \times \pi \times C_{\text{OUT}} \times \text{ESR})) \quad (1)$$

A capacitor placed across the gain resistor R_1 will provide additional phase margin to improve load transient response of the device. This capacitor, C_{FF} , in parallel with R_1 , will form a zero in the loop response given by the formula:

$$F_Z = (1 / (2 \times \pi \times C_{\text{FF}} \times R_1)) \quad (2)$$

For optimum load transient response select C_{FF} so the zero frequency, F_Z , falls between 10 kHz and 15 kHz.

$$(C_{\text{FF}} = (1 / (2 \times \pi \times R_1 \times F_Z))) \quad (3)$$

The phase lead provided by C_{FF} diminishes as the DC gain approaches unity, or V_{OUT} approaches V_{ADJ} . This is because C_{FF} also forms a pole with a frequency of:

$$F_P = (1 / (2 \times \pi \times C_{\text{FF}} \times (R_1 \parallel R_2))) \quad (4)$$

It's important to note that at higher output voltages, where R_1 is much larger than R_2 , the pole and zero are far apart in frequency. At lower output voltages the frequency of the pole and the zero move closer together. The phase lead provided from C_{FF} diminishes quickly as the output voltage is reduced, and has no effect when $V_{\text{OUT}} = V_{\text{ADJ}}$. For this reason, relying on this compensation technique alone is adequate only for higher output voltages. For the LP38853, the practical minimum V_{OUT} is 0.8V when a ceramic capacitor is used for C_{OUT} .

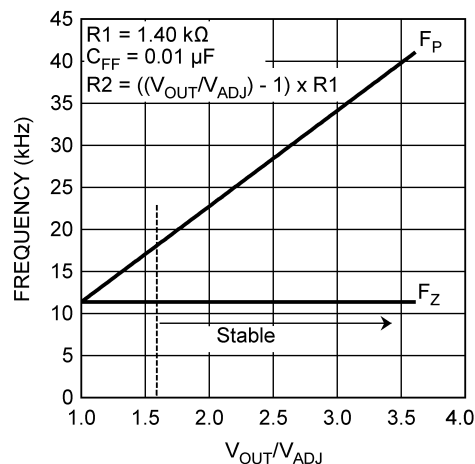

Figure 31. F_{ZERO} and F_{POLE} vs Gain

SETTING THE OUTPUT VOLTAGE

(Refer to the [Typical Application Circuit](#))

The output voltage is set using the external resistive divider R_1 and R_2 . The output voltage is given by the formula:

$$V_{\text{OUT}} = V_{\text{ADJ}} \times \left(1 + \left(\frac{R_1}{R_2} \right) \right) \quad (5)$$

The resistors used for R_1 and R_2 should be high quality, tight tolerance, and with matching temperature coefficients. It is important to remember that, although the value of V_{ADJ} is specified, the use of low quality resistors for R_1 and R_2 can easily produce a V_{OUT} value that is unacceptable.

It is recommended that the values selected for R1 and R2 are such that the parallel value is less than 10 kΩ. This is to prevent internal parasitic capacitances on the ADJ pin from interfering with the F_Z pole set by R1 and C_{FF}.

$$(R1 \times R2) / (R1 + R2) \leq 10 \text{ k}\Omega \quad (6)$$

Table 1 lists some suggested, best fit, standard ±1% resistor values for R1 and R2, and a standard ±10% capacitor values for C_{FF}, for a range of V_{OUT} values. Other values of R1, R2, and C_{FF} are available that will give similar results.

Table 1.

V _{OUT}	R1	R2	C _{FF}	F _Z
0.8V	1.07 kΩ	1.78 kΩ	12 nF	12.4 kHz
0.9V	1.50 kΩ	1.87 kΩ	8.2 nF	12.9 kHz
1.0V	1.00 kΩ	1.00 kΩ	12 nF	13.3 kHz
1.1V	1.65 kΩ	1.37 kΩ	8.2 nF	11.8 kHz
1.2V	1.40 kΩ	1.00 kΩ	10 nF	11.4 kHz
1.3V	1.15 kΩ	715 Ω	12 nF	11.5 kHz
1.4V	1.07 kΩ	590 Ω	12 nF	12.4 kHz
1.5V	2.00 kΩ	1.00 kΩ	6.8 nF	11.7 kHz
1.6V	1.65 kΩ	750 Ω	8.2 nF	11.8 kHz
1.7V	2.55 kΩ	1.07 kΩ	5.6 nF	11.1 kHz
1.8V	2.94 kΩ	1.13 kΩ	4.7 nF	11.5 kHz

Please refer to the TI [AN-1378 Application Report](#) for additional information on how resistor tolerances affect the calculated V_{OUT} value.

INPUT VOLTAGE

The input voltage (V_{IN}) is the high current external voltage rail that will be regulated down to a lower voltage, which is applied to the load. The input voltage must be at least V_{OUT} + V_{DO}, and no higher than whatever value is used for V_{BIAS}.

For applications where V_{BIAS} is higher than 4.5V, V_{IN} must be no greater than 4.5V, otherwise output voltage accuracy may be affected.

BIAS VOLTAGE

The bias voltage (V_{BIAS}) is a low current external voltage rail required to bias the control circuitry and provide gate drive for the N-FET pass transistor. When V_{OUT} is set to 1.20V, or less, V_{BIAS} may be anywhere in the operating range of 3.0V to 5.5V. If V_{OUT} is set higher than 1.20V, V_{BIAS} must be between 4.5V and 5.5V to ensure proper operation of the device.

UNDER VOLTAGE LOCKOUT

The bias voltage is monitored by a circuit which prevents the device from functioning when the bias voltage is below the Under-Voltage Lock-Out (UVLO) threshold of approximately 2.45V.

As the bias voltage rises above the UVLO threshold the device control circuitry becomes active. There is approximately 150 mV of hysteresis built into the UVLO threshold to provide noise immunity.

When the bias voltage is between the UVLO threshold and the Minimum Operating Rating value of 3.0V the device will be functional, but the operating parameters will not be within the specified limits.

SUPPLY SEQUENCING

There is no requirement for the order that V_{IN} or V_{BIAS} are applied or removed.

One practical limitation is that the Soft-Start circuit starts charging C_{SS} when both V_{BIAS} rises above the UVLO threshold and the Enable pin is above the V_{EN(ON)} threshold. If the application of V_{IN} is delayed beyond this point the benefits of Soft-Start will be compromised.

In any case, the output voltage cannot be ensured until both V_{IN} and V_{BIAS} are within the range of specified operating values.

If used in a dual-supply system where the regulator output load is returned to a negative supply, the output pin must be diode clamped to ground. A Schottky diode is recommended for this diode clamp.

REVERSE VOLTAGE

A reverse voltage condition will exist when the voltage at the output pin is higher than the voltage at the input pin. Typically this will happen when V_{IN} is abruptly taken low and C_{OUT} continues to hold a sufficient charge such that the input to output voltage becomes reversed.

The NMOS pass element, by design, contains no body diode. This means that, as long as the gate of the pass element is not driven, there will not be any reverse current flow through the pass element during a reverse voltage event. The gate of the pass element is not driven when V_{BIAS} is below the UVLO threshold, or when the Enable pin is held low.

When V_{BIAS} is above the UVLO threshold, and the Enable pin is above the $V_{EN(ON)}$ threshold, the control circuitry is active and will attempt to regulate the output voltage. Since the input voltage is less than the output voltage the control circuit will drive the gate of the pass element to the full V_{BIAS} potential when the output voltage begins to fall. In this condition, reverse current will flow from the output pin to the input pin, limited only by the $R_{DS(ON)}$ of the pass element and the output to input voltage differential. Discharging an output capacitor up to 1000 μF in this manner will not damage the device as the current will rapidly decay. However, continuous reverse current should be avoided.

SOFT-START

The LP38853 incorporates a Soft-Start function that reduces the start-up current surge into the output capacitor (C_{OUT}) by allowing V_{OUT} to rise slowly to the final value. This is accomplished by controlling V_{REF} at the SS pin. The soft-start timing capacitor (C_{SS}) is internally held to ground until both V_{BIAS} rises above the Under-Voltage Lock-Out threshold (ULVO) and the Enable pin is higher than the $V_{EN(ON)}$ threshold.

V_{REF} will rise at an RC rate defined by the internal resistance of the SS pin (r_{SS}), and the external capacitor connected to the SS pin. This allows the output voltage to rise in a controlled manner until steady-state regulation is achieved. Typically, five time constants are recommended to assure that the output voltage is sufficiently close to the final steady-state value. During the soft-start time the output current can rise to the built-in current limit.

$$\text{Soft-Start Time} = C_{SS} \times r_{SS} \times 5 \quad (7)$$

Since the V_{OUT} rise will be exponential, not linear, the in-rush current will peak during the first time constant (τ), and V_{OUT} will require four additional time constants (4τ) to reach the final value (5τ).

After achieving normal operation, should either V_{BIAS} fall below the ULVO threshold, or the Enable pin fall below the $V_{EN(OFF)}$ threshold, the device output will be disabled and the Soft-Start capacitor (C_{SS}) discharge circuit will become active. The C_{SS} discharge circuit will remain active until V_{BIAS} falls to 500 mV (typical). When V_{BIAS} falls below 500 mV (typical), the C_{SS} discharge circuit will cease to function due to a lack of sufficient biasing to the control circuitry.

Since V_{REF} appears on the SS pin, any leakage through C_{SS} will cause V_{REF} to fall, and thus affect V_{OUT} . A leakage of 50 nA (about 10 M Ω) through C_{SS} will cause V_{OUT} to be approximately 0.1% lower than nominal, while a leakage of 500 nA (about 1 M Ω) will cause V_{OUT} to be approximately 1% lower than nominal. Typical ceramic capacitors will have a factor of 10X difference in leakage between 25°C and 85°C, so the maximum ambient temperature must be included in the capacitor selection process.

Typical C_{SS} values will be in the range of 1 nF to 100 nF, providing typical Soft-Start times in the range of 70 μs to 7 ms (5τ). Values less than 1 nF can be used, but the Soft-Start effect will be minimal. Values larger than 100 nF will provide soft-start, but may not be fully discharged if V_{BIAS} falls from the UVLVO threshold to less than 500 mV in less than 100 μs .

Figure 32 shows the relationship between the C_{OUT} value and a typical C_{SS} value.

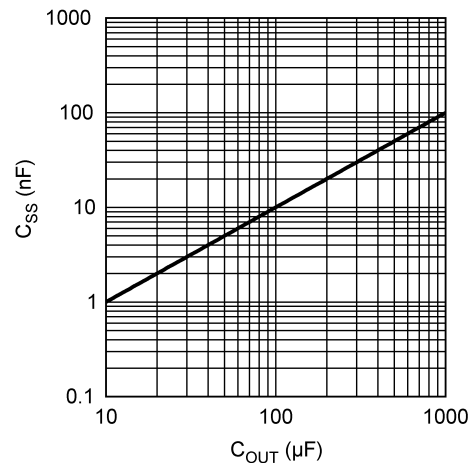

Figure 32. Typical C_{SS} vs C_{OUT} Values

The C_{SS} capacitor must be connected to a clean ground path back to the device ground pin. No components, other than C_{SS}, should be connected to the SS pin, as there could be adverse effects to V_{OUT}.

If the Soft-Start function is not needed the SS pin should be left open, although some minimal capacitance value is always recommended.

ENABLE OPERATION

The Enable pin (EN) provides a mechanism to enable, or disable, the regulator output stage. The Enable pin has an internal pull-up, through a typical 180 kΩ resistor, to V_{BIAS}.

If the Enable pin is actively driven, pulling the Enable pin above the V_{EN} threshold of 1.25V (typical) will turn the regulator output on, while pulling the Enable pin below the V_{EN} threshold will turn the regulator output off. There is approximately 100 mV of hysteresis built into the Enable threshold provide noise immunity.

If the Enable function is not needed this pin should be left open, or connected directly to V_{BIAS}. If the Enable pin is left open, stray capacitance on this pin must be minimized, otherwise the output turn-on will be delayed while the stray capacitance is charged through the internal resistance (r_{EN}).

POWER DISSIPATION AND HEAT-SINKING

Additional copper area for heat-sinking may be required depending on the maximum device dissipation (P_D) and the maximum anticipated ambient temperature (T_A) for the device. Under all possible conditions, the junction temperature must be within the range specified under operating conditions.

The total power dissipation of the device is the sum of three different points of dissipation in the device.

The first part is the power that is dissipated in the NMOS pass element, and can be determined with the formula:

$$P_{D(PASS)} = (V_{IN} - V_{OUT}) \times I_{OUT} \quad (8)$$

The second part is the power that is dissipated in the bias and control circuitry, and can be determined with the formula:

$$P_{D(BIAS)} = V_{BIAS} \times I_{GND(BIAS)}$$

where

- I_{GND(BIAS)} is the portion of the operating ground current of the device that is related to V_{BIAS}. (9)

The third part is the power that is dissipated in portions of the output stage circuitry, and can be determined with the formula:

$$P_{D(IN)} = V_{IN} \times I_{GND(IN)}$$

where

- I_{GND(IN)} is the portion of the operating ground current of the device that is related to V_{IN}. (10)

The total power dissipation is then:

$$P_D = P_{D(PASS)} + P_{D(BIAS)} + P_{D(IN)} \quad (11)$$

The maximum allowable junction temperature rise (ΔT_J) depends on the maximum anticipated ambient temperature (T_A) for the application, and the maximum allowable operating junction temperature ($T_{J(MAX)}$).

$$\Delta T_J = T_{J(MAX)} - T_{A(MAX)} \quad (12)$$

The maximum allowable value for junction to ambient Thermal Resistance, θ_{JA} , can be calculated using the formula:

$$\theta_{JA} \leq \frac{\Delta T_J}{P_D} \quad (13)$$

Heat-Sinking The PFM Package

The PFM package has a θ_{JA} rating of 60°C/W and a θ_{JC} rating of 3°C/W. These ratings are for the package only, no additional heat-sinking, and with no airflow. If the needed θ_{JA} , as calculated above, is greater than or equal to 60°C/W then no additional heat-sinking is required since the package can safely dissipate the heat and not exceed the operating $T_{J(MAX)}$. If the needed θ_{JA} is less than 60°C/W then additional heat-sinking is needed.

The thermal resistance of a PFM package can be reduced by attaching it to a heat sink or a copper plane on a PC board. If a copper plane is to be used, the values of θ_{JA} will be same as shown in next section for DDPAK package.

The heat-sink to be used in the application should have a heat-sink to ambient thermal resistance, θ_{HA} :

$$\theta_{HA} \leq \theta_{JA} - (\theta_{CH} + \theta_{JC})$$

where

- θ_{JA} is the required total thermal resistance from the junction to the ambient air
- θ_{CH} is the thermal resistance from the case to the surface of the heat-sink
- θ_{JC} is the thermal resistance from the junction to the surface of the case. (14)

For this equation, θ_{JC} is about 3°C/W for a PFM package. The value for θ_{CH} depends on method of attachment, insulator, etc. θ_{CH} varies between 1.5°C/W to 2.5°C/W. Consult the heat-sink manufacturer datasheet for details and recommendations.

Heat-Sinking The DDPAK Package

The DDPAK package has a θ_{JA} rating of 60°C/W, and a θ_{JC} rating of 3°C/W. These ratings are for the package only, no additional heat-sinking, and with no airflow.

The DDPAK package uses the copper plane on the PCB as a heat-sink. The tab of this package is soldered to the copper plane for heat sinking. [Figure 33](#) shows a curve for the θ_{JA} of DDPAK package for different copper area sizes, using a typical PCB with 1 ounce copper and no solder mask over the copper area for heat-sinking.

[Figure 33](#) shows that increasing the copper area beyond 1 square inch produces very little improvement. The minimum value for θ_{JA} for the DDPAK package mounted to a PCB is 32°C/W.

[Figure 34](#) shows the maximum allowable power dissipation for DDPAK packages for different ambient temperatures, assuming θ_{JA} is 35°C/W and the maximum junction temperature is 125°C.

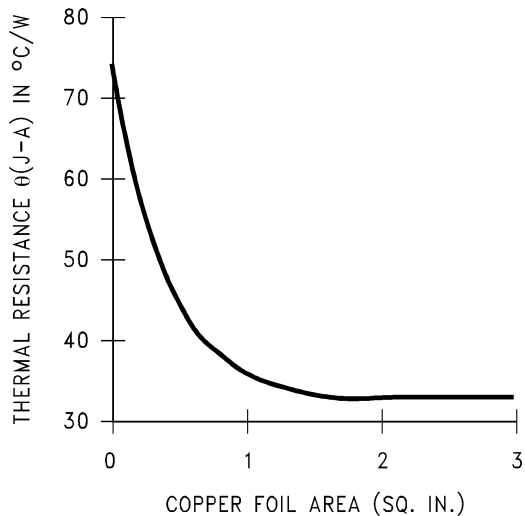

Figure 33. θ_{JA} vs Copper (1 Ounce) Area for the DDPAK package

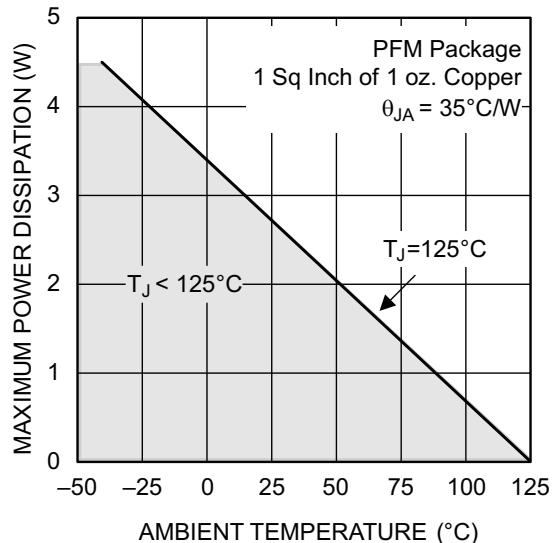

Figure 34. 101Maximum Power Dissipation vs Ambient Temperature for the DDPAK Package

Heat-Sinking The SO PowerPAD-8 Package

The LP38853MR package has a θ_{JA} rating of 168°C/W, and a θ_{JC} rating of 11°C/W. The θ_{JA} rating of 168°C/W includes the device DAP soldered to an area of 0.008 square inches (0.09 in x 0.09 in) of 1 ounce copper, with no airflow.

Increasing the copper area soldered to the DAP to 1 square inch of 1 ounce copper, using a dog-bone type layout, will improve the θ_{JA} rating to 98°C/W. Figure 35 shows that increasing the copper area beyond 1 square inch produces very little improvement.

Figure 36 shows the maximum allowable power dissipation for the SO PowerPAD-8 package for a range of ambient temperatures, assuming θ_{JA} is 98°C/W and the maximum junction temperature is 125°C.

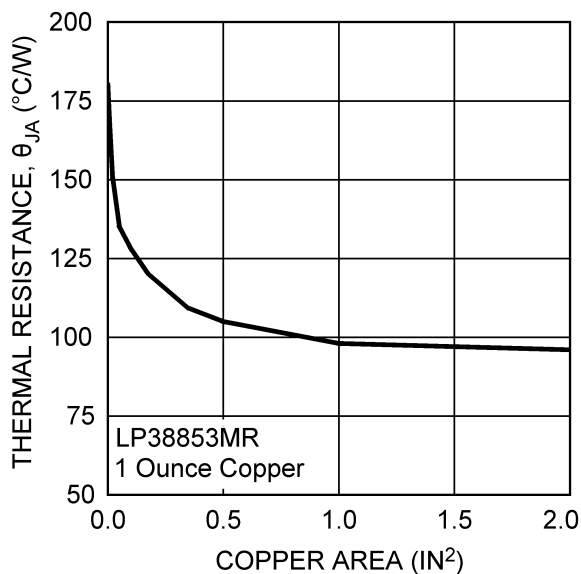

Figure 35. θ_{JA} vs Copper (1 Ounce) Area for the SO PowerPAD-8 Package

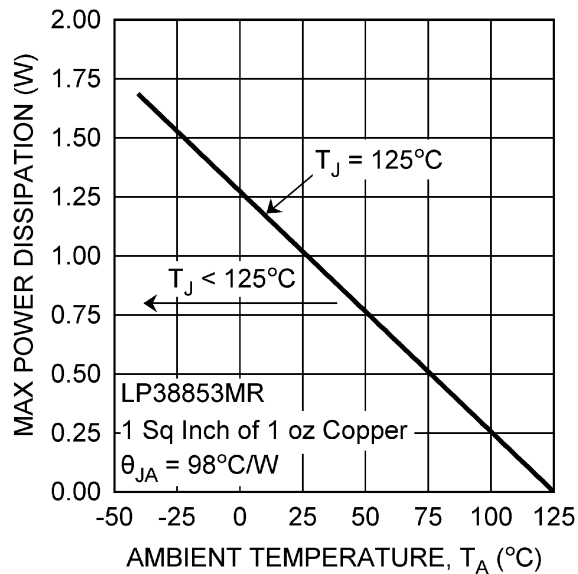

Figure 36. Maximum Power Dissipation vs Ambient Temperature for the SO PowerPAD-8 Package

REVISION HISTORY

Changes from Revision C (April 2013) to Revision D	Page
• Changed layout of National Data Sheet to TI format	17

PACKAGING INFORMATION

Orderable Device	Status (1)	Package Type	Package Drawing	Pins	Package Qty	Eco Plan (2)	Lead/Ball Finish (6)	MSL Peak Temp (3)	Op Temp (°C)	Device Marking (4/5)	Samples
LP38853MR-ADJ	NRND	SO PowerPAD	DDA	8	95	TBD	Call TI	Call TI	-40 to 125	L38853 MRADJ	
LP38853MR-ADJ/NOPB	ACTIVE	SO PowerPAD	DDA	8	95	Green (RoHS & no Sb/Br)	CU SN	Level-3-260C-168 HR	-40 to 125	L38853 MRADJ	Samples
LP38853MRX-ADJ/NOPB	ACTIVE	SO PowerPAD	DDA	8	2500	Green (RoHS & no Sb/Br)	CU SN	Level-3-260C-168 HR	-40 to 125	L38853 MRADJ	Samples
LP38853S-ADJ	NRND	DDPAK/ TO-263	KTW	7	45	TBD	Call TI	Call TI	-40 to 125	LP38853S ADJ	
LP38853S-ADJ/NOPB	ACTIVE	DDPAK/ TO-263	KTW	7	45	Pb-Free (RoHS Exempt)	CU SN	Level-3-245C-168 HR	-40 to 125	LP38853S ADJ	Samples
LP38853SX-ADJ/NOPB	ACTIVE	DDPAK/ TO-263	KTW	7	500	Pb-Free (RoHS Exempt)	CU SN	Level-3-245C-168 HR	-40 to 125	LP38853S ADJ	Samples
LP38853T-ADJ/NOPB	ACTIVE	TO-220	NDZ	7	45	Green (RoHS & no Sb/Br)	CU SN	Level-1-NA-UNLIM	-40 to 125	LP38853T ADJ	Samples

(1) The marketing status values are defined as follows:

ACTIVE: Product device recommended for new designs.

LIFEBUY: TI has announced that the device will be discontinued, and a lifetime-buy period is in effect.

NRND: Not recommended for new designs. Device is in production to support existing customers, but TI does not recommend using this part in a new design.

PREVIEW: Device has been announced but is not in production. Samples may or may not be available.

OBSOLETE: TI has discontinued the production of the device.

(2) Eco Plan - The planned eco-friendly classification: Pb-Free (RoHS), Pb-Free (RoHS Exempt), or Green (RoHS & no Sb/Br) - please check <http://www.ti.com/productcontent> for the latest availability information and additional product content details.

TBD: The Pb-Free/Green conversion plan has not been defined.

Pb-Free (RoHS): TI's terms "Lead-Free" or "Pb-Free" mean semiconductor products that are compatible with the current RoHS requirements for all 6 substances, including the requirement that lead not exceed 0.1% by weight in homogeneous materials. Where designed to be soldered at high temperatures, TI Pb-Free products are suitable for use in specified lead-free processes.

Pb-Free (RoHS Exempt): This component has a RoHS exemption for either 1) lead-based flip-chip solder bumps used between the die and package, or 2) lead-based die adhesive used between the die and leadframe. The component is otherwise considered Pb-Free (RoHS compatible) as defined above.

Green (RoHS & no Sb/Br): TI defines "Green" to mean Pb-Free (RoHS compatible), and free of Bromine (Br) and Antimony (Sb) based flame retardants (Br or Sb do not exceed 0.1% by weight in homogeneous material)

(3) MSL, Peak Temp. - The Moisture Sensitivity Level rating according to the JEDEC industry standard classifications, and peak solder temperature.

(4) There may be additional marking, which relates to the logo, the lot trace code information, or the environmental category on the device.

⁽⁵⁾ Multiple Device Markings will be inside parentheses. Only one Device Marking contained in parentheses and separated by a "-" will appear on a device. If a line is indented then it is a continuation of the previous line and the two combined represent the entire Device Marking for that device.

⁽⁶⁾ Lead/Ball Finish - Orderable Devices may have multiple material finish options. Finish options are separated by a vertical ruled line. Lead/Ball Finish values may wrap to two lines if the finish value exceeds the maximum column width.

Important Information and Disclaimer:The information provided on this page represents TI's knowledge and belief as of the date that it is provided. TI bases its knowledge and belief on information provided by third parties, and makes no representation or warranty as to the accuracy of such information. Efforts are underway to better integrate information from third parties. TI has taken and continues to take reasonable steps to provide representative and accurate information but may not have conducted destructive testing or chemical analysis on incoming materials and chemicals. TI and TI suppliers consider certain information to be proprietary, and thus CAS numbers and other limited information may not be available for release.

In no event shall TI's liability arising out of such information exceed the total purchase price of the TI part(s) at issue in this document sold by TI to Customer on an annual basis.

TAPE AND REEL INFORMATION



QUADRANT ASSIGNMENTS FOR PIN 1 ORIENTATION IN TAPE



*All dimensions are nominal

Device	Package Type	Package Drawing	Pins	SPQ	Reel Diameter (mm)	Reel Width W1 (mm)	A0 (mm)	B0 (mm)	K0 (mm)	P1 (mm)	W (mm)	Pin1 Quadrant
LP38853MRX-ADJ/NOPB	SO Power PAD	DDA	8	2500	330.0	12.4	6.5	5.4	2.0	8.0	12.0	Q1
LP38853SX-ADJ/NOPB	DDPAK/TO-263	KTW	7	500	330.0	24.4	10.75	14.85	5.0	16.0	24.0	Q2

TAPE AND REEL BOX DIMENSIONS

*All dimensions are nominal

Device	Package Type	Package Drawing	Pins	SPQ	Length (mm)	Width (mm)	Height (mm)
LP38853MRX-ADJ/NOPB	SO PowerPAD	DDA	8	2500	367.0	367.0	35.0
LP38853SX-ADJ/NOPB	DDPAK/TO-263	KTW	7	500	367.0	367.0	45.0

NDZ0007B

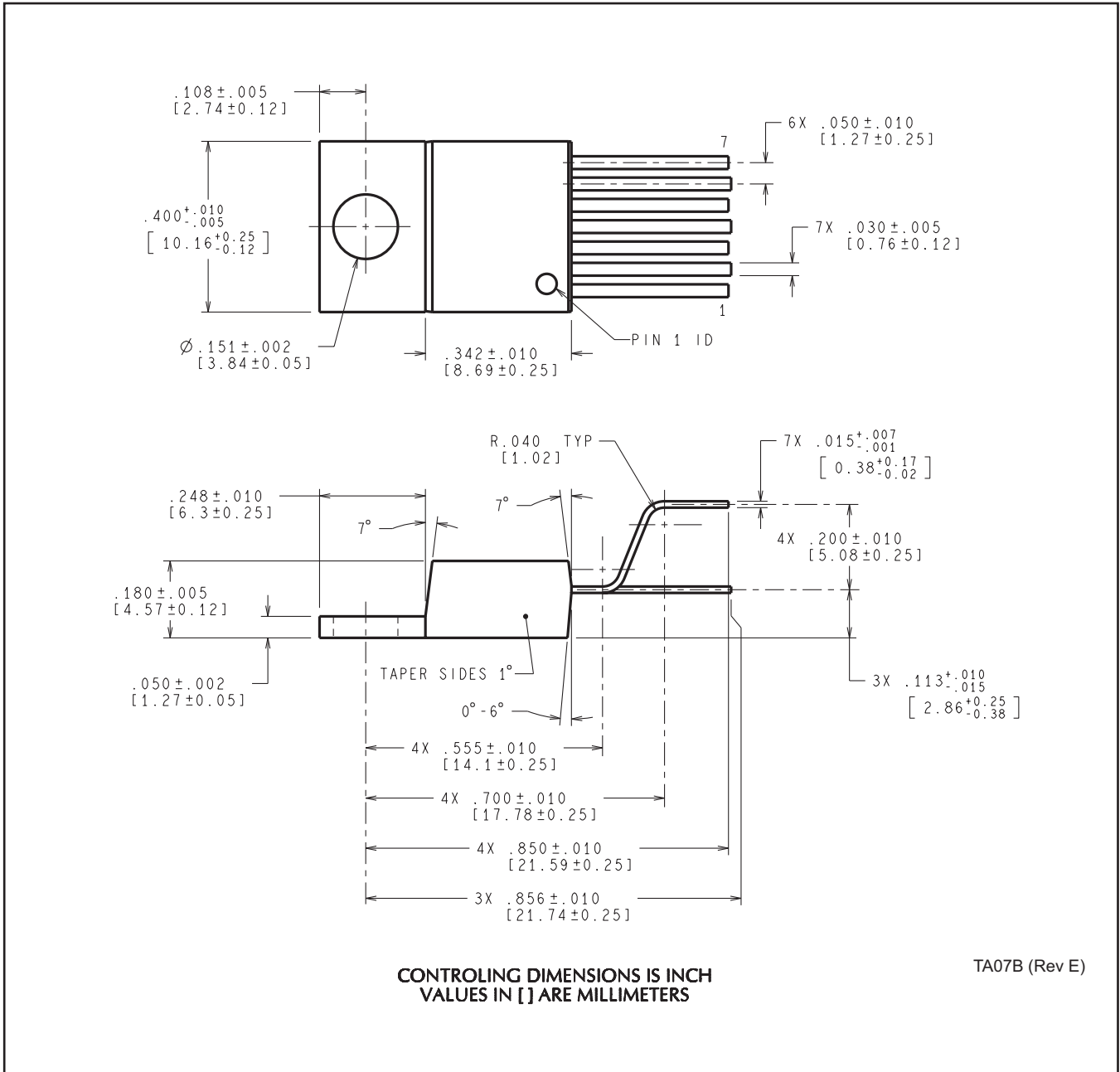

DDA (R-PDSO-G8)

PowerPAD™ PLASTIC SMALL OUTLINE

THERMAL INFORMATION

This PowerPAD™ package incorporates an exposed thermal pad that is designed to be attached to a printed circuit board (PCB). The thermal pad must be soldered directly to the PCB. After soldering, the PCB can be used as a heatsink. In addition, through the use of thermal vias, the thermal pad can be attached directly to the appropriate copper plane shown in the electrical schematic for the device, or alternatively, can be attached to a special heatsink structure designed into the PCB. This design optimizes the heat transfer from the integrated circuit (IC).

For additional information on the PowerPAD package and how to take advantage of its heat dissipating abilities, refer to Technical Brief, PowerPAD Thermally Enhanced Package, Texas Instruments Literature No. SLMA002 and Application Brief, PowerPAD Made Easy, Texas Instruments Literature No. SLMA004. Both documents are available at www.ti.com.

The exposed thermal pad dimensions for this package are shown in the following illustration.

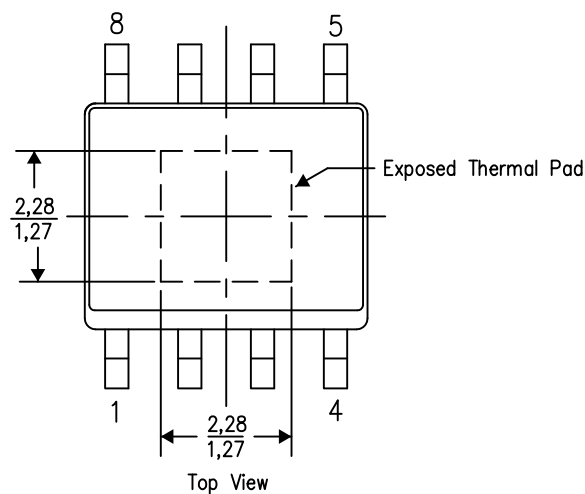

Exposed Thermal Pad Dimensions

4206322-2/L 05/12

NOTE: A. All linear dimensions are in millimeters

PowerPAD is a trademark of Texas Instruments

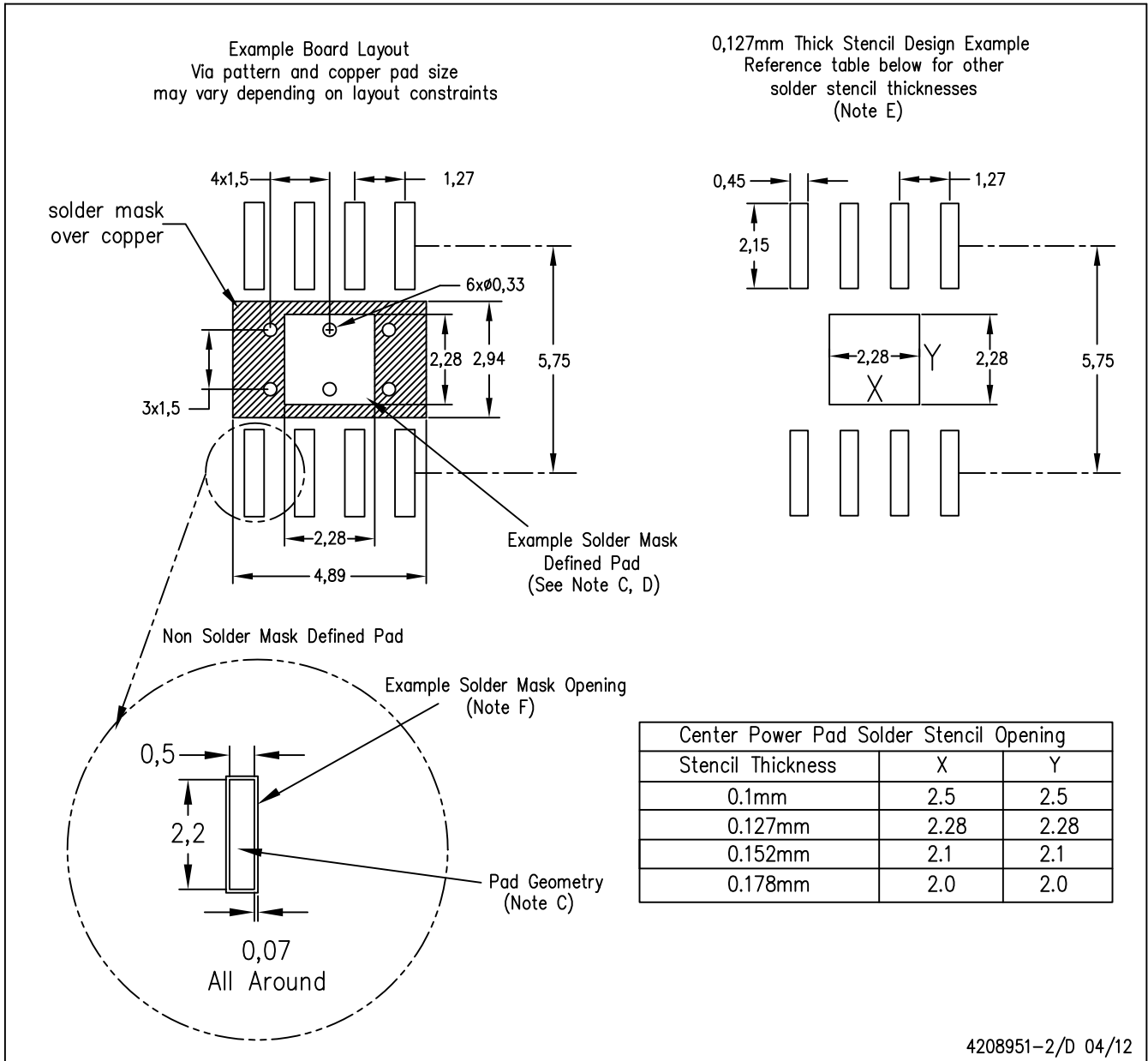

4208951-2/D 04/12

- NOTES:
- A. All linear dimensions are in millimeters.
 - B. This drawing is subject to change without notice.
 - C. Publication IPC-7351 is recommended for alternate designs.
 - D. This package is designed to be soldered to a thermal pad on the board. Refer to Technical Brief, PowerPAD Thermally Enhanced Package, Texas Instruments Literature No. SLMA002, SLMA004, and also the Product Data Sheets for specific thermal information, via requirements, and recommended board layout. These documents are available at www.ti.com <<http://www.ti.com>>. Publication IPC-7351 is recommended for alternate designs.
 - E. Laser cutting apertures with trapezoidal walls and also rounding corners will offer better paste release. Customers should contact their board assembly site for stencil design recommendations. Example stencil design based on a 50% volumetric metal load solder paste. Refer to IPC-7525 for other stencil recommendations.
 - F. Customers should contact their board fabrication site for solder mask tolerances between and around signal pads.

PowerPAD is a trademark of Texas Instruments.

DDA0008A

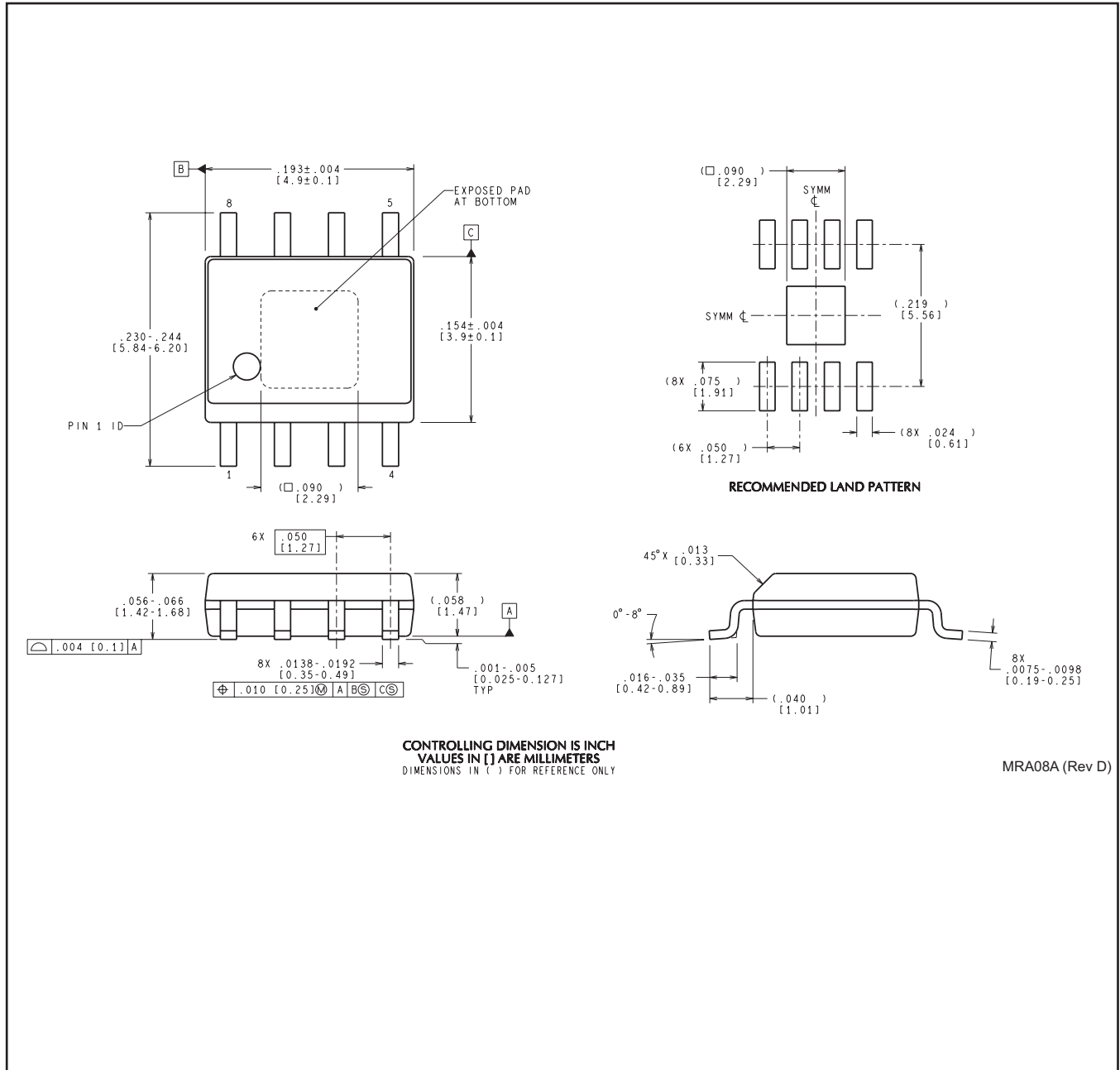

MRA08A (Rev D)

KTW0007B

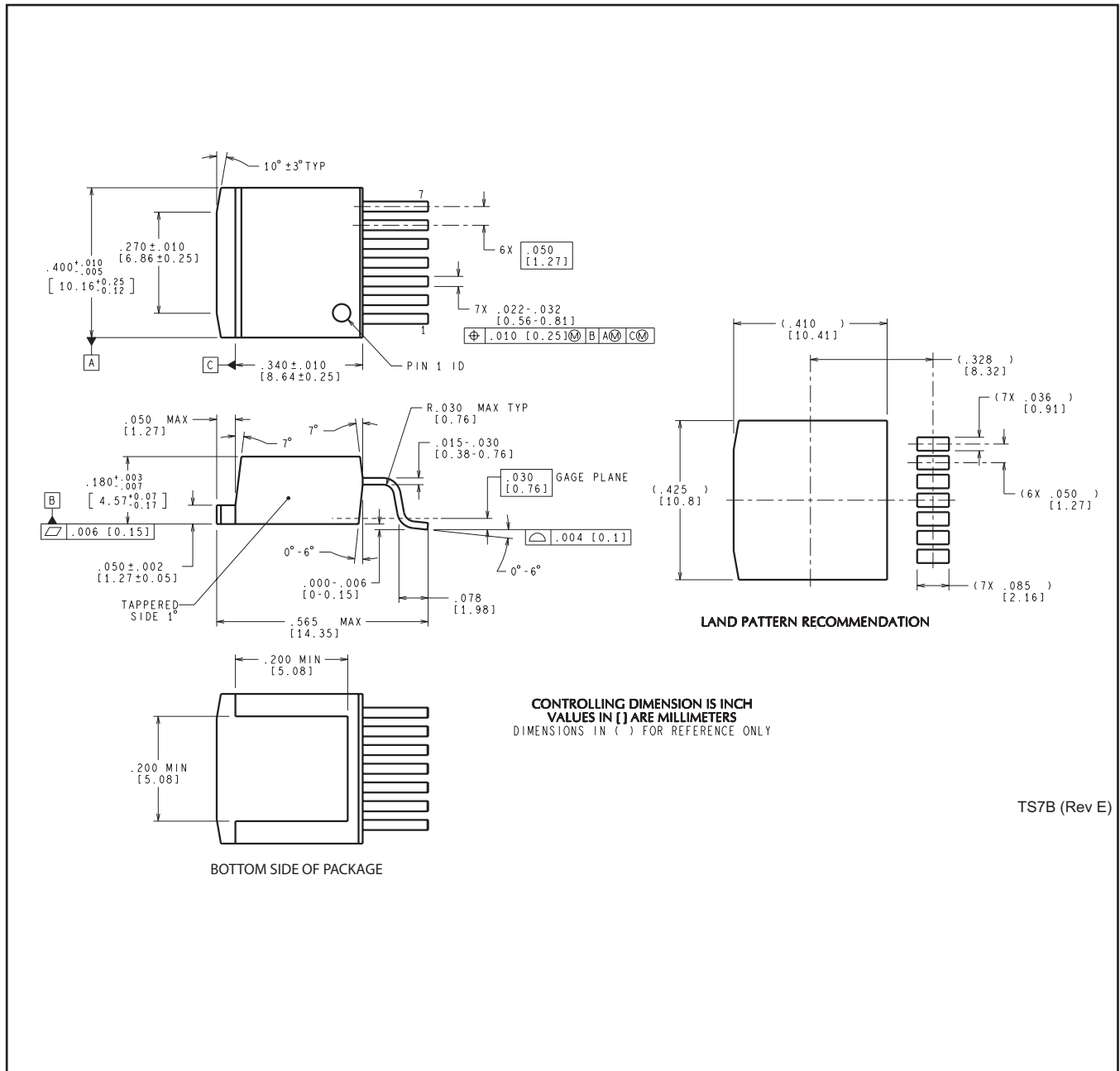

TS7B (Rev E)

IMPORTANT NOTICE

Texas Instruments Incorporated and its subsidiaries (TI) reserve the right to make corrections, enhancements, improvements and other changes to its semiconductor products and services per JESD46, latest issue, and to discontinue any product or service per JESD48, latest issue. Buyers should obtain the latest relevant information before placing orders and should verify that such information is current and complete. All semiconductor products (also referred to herein as "components") are sold subject to TI's terms and conditions of sale supplied at the time of order acknowledgment.

TI warrants performance of its components to the specifications applicable at the time of sale, in accordance with the warranty in TI's terms and conditions of sale of semiconductor products. Testing and other quality control techniques are used to the extent TI deems necessary to support this warranty. Except where mandated by applicable law, testing of all parameters of each component is not necessarily performed.

TI assumes no liability for applications assistance or the design of Buyers' products. Buyers are responsible for their products and applications using TI components. To minimize the risks associated with Buyers' products and applications, Buyers should provide adequate design and operating safeguards.

TI does not warrant or represent that any license, either express or implied, is granted under any patent right, copyright, mask work right, or other intellectual property right relating to any combination, machine, or process in which TI components or services are used. Information published by TI regarding third-party products or services does not constitute a license to use such products or services or a warranty or endorsement thereof. Use of such information may require a license from a third party under the patents or other intellectual property of the third party, or a license from TI under the patents or other intellectual property of TI.

Reproduction of significant portions of TI information in TI data books or data sheets is permissible only if reproduction is without alteration and is accompanied by all associated warranties, conditions, limitations, and notices. TI is not responsible or liable for such altered documentation. Information of third parties may be subject to additional restrictions.

Resale of TI components or services with statements different from or beyond the parameters stated by TI for that component or service voids all express and any implied warranties for the associated TI component or service and is an unfair and deceptive business practice. TI is not responsible or liable for any such statements.

Buyer acknowledges and agrees that it is solely responsible for compliance with all legal, regulatory and safety-related requirements concerning its products, and any use of TI components in its applications, notwithstanding any applications-related information or support that may be provided by TI. Buyer represents and agrees that it has all the necessary expertise to create and implement safeguards which anticipate dangerous consequences of failures, monitor failures and their consequences, lessen the likelihood of failures that might cause harm and take appropriate remedial actions. Buyer will fully indemnify TI and its representatives against any damages arising out of the use of any TI components in safety-critical applications.

In some cases, TI components may be promoted specifically to facilitate safety-related applications. With such components, TI's goal is to help enable customers to design and create their own end-product solutions that meet applicable functional safety standards and requirements. Nonetheless, such components are subject to these terms.

No TI components are authorized for use in FDA Class III (or similar life-critical medical equipment) unless authorized officers of the parties have executed a special agreement specifically governing such use.

Only those TI components which TI has specifically designated as military grade or "enhanced plastic" are designed and intended for use in military/aerospace applications or environments. Buyer acknowledges and agrees that any military or aerospace use of TI components which have **not** been so designated is solely at the Buyer's risk, and that Buyer is solely responsible for compliance with all legal and regulatory requirements in connection with such use.

TI has specifically designated certain components as meeting ISO/TS16949 requirements, mainly for automotive use. In any case of use of non-designated products, TI will not be responsible for any failure to meet ISO/TS16949.

Products

Audio	www.ti.com/audio
Amplifiers	amplifier.ti.com
Data Converters	dataconverter.ti.com
DLP® Products	www.dlp.com
DSP	dsp.ti.com
Clocks and Timers	www.ti.com/clocks
Interface	interface.ti.com
Logic	logic.ti.com
Power Mgmt	power.ti.com
Microcontrollers	microcontroller.ti.com
RFID	www.ti-rfid.com
OMAP Applications Processors	www.ti.com/omap
Wireless Connectivity	www.ti.com/wirelessconnectivity

Applications

Automotive and Transportation	www.ti.com/automotive
Communications and Telecom	www.ti.com/communications
Computers and Peripherals	www.ti.com/computers
Consumer Electronics	www.ti.com/consumer-apps
Energy and Lighting	www.ti.com/energy
Industrial	www.ti.com/industrial
Medical	www.ti.com/medical
Security	www.ti.com/security
Space, Avionics and Defense	www.ti.com/space-avionics-defense
Video and Imaging	www.ti.com/video

TI E2E Community

e2e.ti.com