

SS=2.8ms

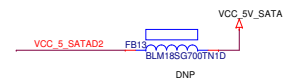
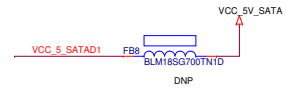
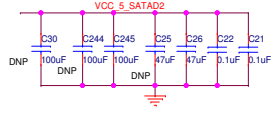
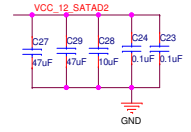
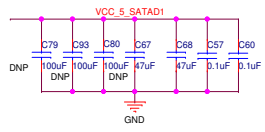
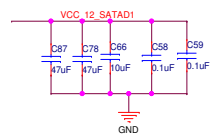
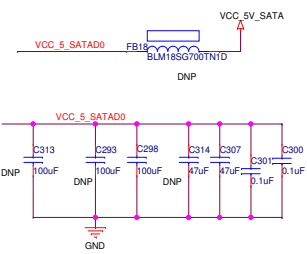
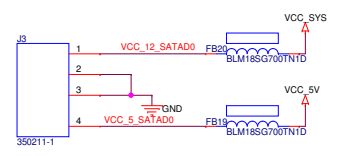
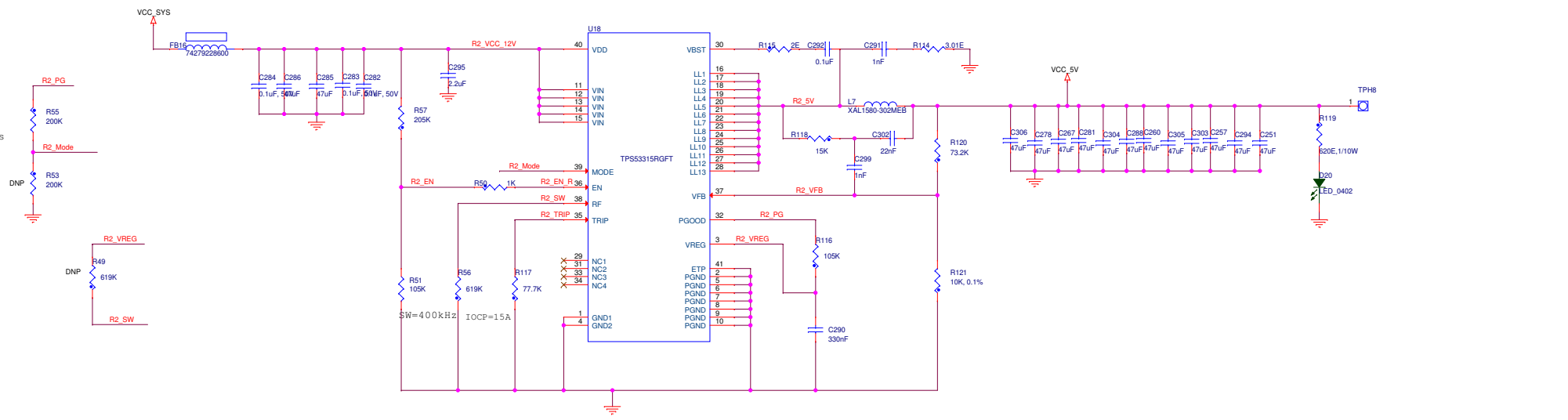

| | | | |
|-------|------------------------------|-------|--------|
| Title | <Title> | Rev | <Rev> |
| Size | Document Number | | |
| C | <Doc> | | |
| Date: | Wednesday, December 15, 2021 | Sheet | 1 of 1 |