

S N O K S C R E E R R M M W A R S I D E D E
TPL7407L/TPL7408L
DESIGNED BY SVTRONICS, INC.
(12-31-13)

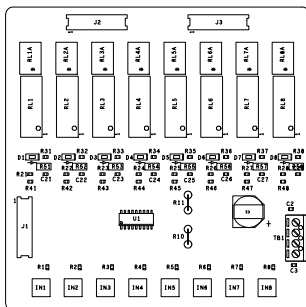

ASSEMBLY DRAWING - PRIMARY SIDE
TPL7407L/TPL7408L
DESIGNED BY SVTRONICS, INC.
(12-31-13)

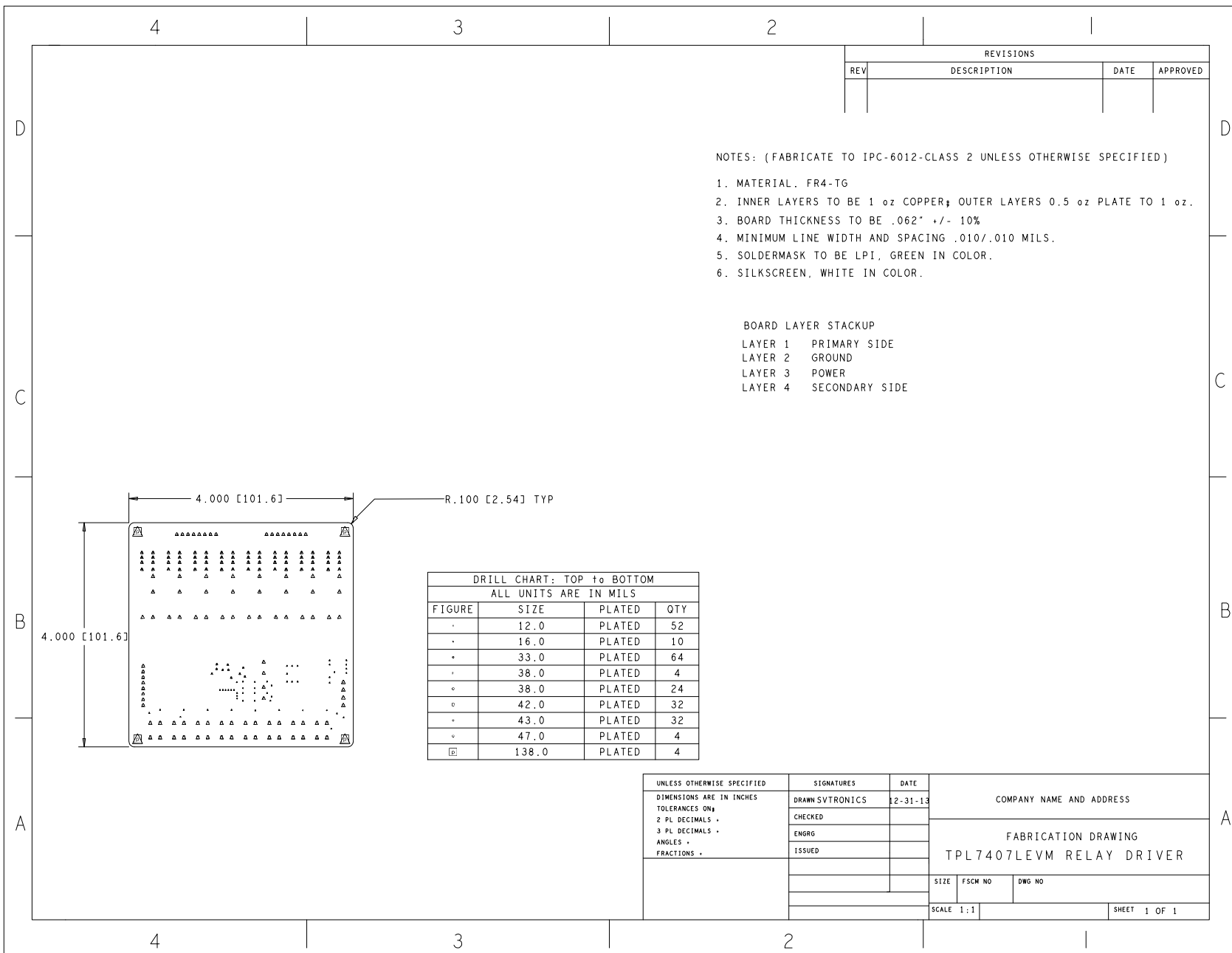

REVISIONS			
REV	DESCRIPTION	DATE	APPROVED

NOTES: (FABRICATE TO IPC-6012-CLASS 2 UNLESS OTHERWISE SPECIFIED)

1. MATERIAL . FR4-TG
2. INNER LAYERS TO BE 1 oz COPPER; OUTER LAYERS 0.5 oz PLATE TO 1 oz.
3. BOARD THICKNESS TO BE .062" +/- 10%
4. MINIMUM LINE WIDTH AND SPACING .010/.010 MILS.
5. SOLDERMASK TO BE LPI, GREEN IN COLOR.
6. SILKSCREEN, WHITE IN COLOR.

BOARD LAYER STACKUP
 LAYER 1 PRIMARY SIDE
 LAYER 2 GROUND
 LAYER 3 POWER
 LAYER 4 SECONDARY SIDE

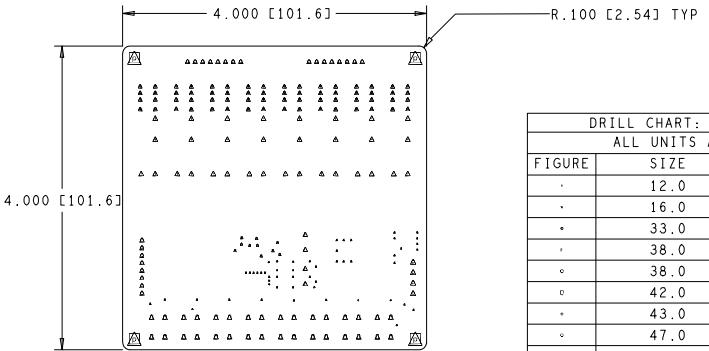

DRILL CHART: TOP to BOTTOM			
ALL UNITS ARE IN MILS			
FIGURE	SIZE	PLATED	QTY
•	12.0	PLATED	52
•	16.0	PLATED	10
•	33.0	PLATED	64
•	38.0	PLATED	4
◦	38.0	PLATED	24
◦	42.0	PLATED	32
•	43.0	PLATED	32
◦	47.0	PLATED	4
◻	138.0	PLATED	4

UNLESS OTHERWISE SPECIFIED	SIGNATURES	DATE	COMPANY NAME AND ADDRESS
DIMENSIONS ARE IN INCHES TOLERANCES ON: 2 PL DECIMALS - 3 PL DECIMALS - ANGLES - FRACTIONS -	DRAWN SVTRONICS	12-31-13	
	CHECKED		FABRICATION DRAWING TPL7407LEVM RELAY DRIVER
	ENGRG		
	ISSUED		
			SIZE FSCM NO DWG NO
			SCALE 1:1 SHEET 1 OF 1

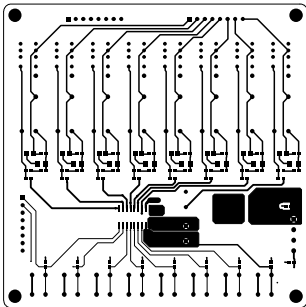

LAYER 1 (PRIMARY SIDE)
TPL7407L/TPL7408L
DESIGNED BY SVTRONICS, INC.
(12-31-13)

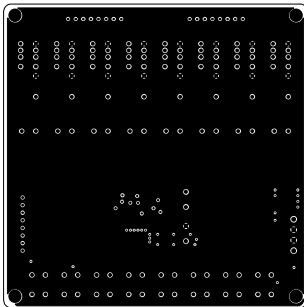

LAYER 2 (GROUND PLANE)
TPL7407L/TPL7408L
DESIGNED BY SVTRONICS, INC.
(12-31-13)

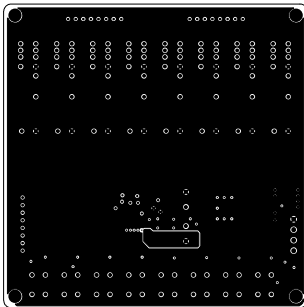

LAYER 3 (+28V PLANE)
TPL7407L/TPL7408L
DESIGNED BY SVTRONICS, INC.
(12-31-13)

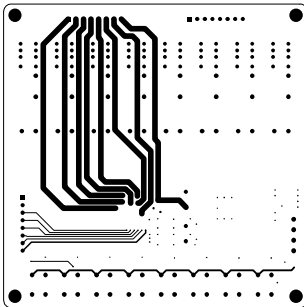

LAYER 4 (SECONDARY SIDE)
TPL7407L/TPL7408L
DESIGNED BY SVTRONICS, INC.
(12-31-13)

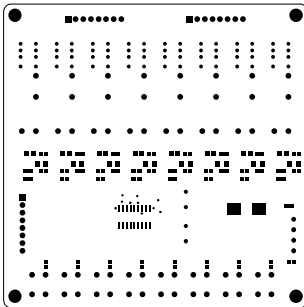

SOLDERMASK -PRIMARY SIDE
TPL7407L/TPL7408L
DESIGNED BY SVTRONICS, INC.
(12-31-13)

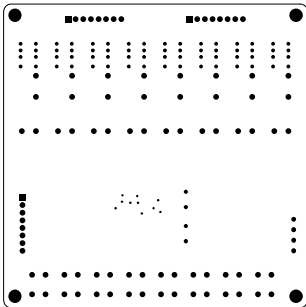

SOLDERMARK - SECONDARY SIDE
TPL7407L/TPL7408L
DESIGNED BY SVTRONICS, INC.
(12-31-13)

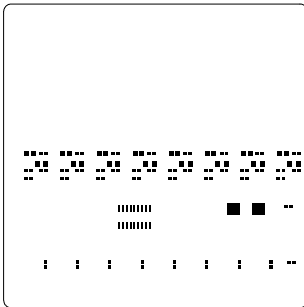

SOLDER PASTE (PRIMARY SIDE)
TPL7407L/TPL7408L
DESIGNED BY SVTRONICS, INC.
(12-31-13)

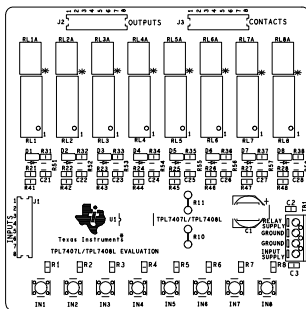

SILKSCREEN PRIMARY SIDE
TPL7407L/TPL7408L
DESIGNED BY SVTRONICS, INC.
(12-31-13)