

TPS61175 SEPIC Design

Jeff Falin

PMP - DC/DC Low-Power Converters

Design Example

When a dc/dc converter providing a regulated output voltage between the minimum and maximum input voltage is required, neither a single buck or a boost converter can provide the output voltage. However, a boost converter integrated circuit (IC) can be configured to drive a single-ended, primary-inductor converter (SEPIC) power stage and provide an output voltage that is between the input voltage extremes. The following design example helps a user design a 12-V power supply from a 9-V to 15-V input power source using the TPS61175 boost converter IC in the SEPIC configuration. The Texas Instruments application report [SLYT309](#) gives detailed explanations of how the SEPIC converter operates and provides more information on the equations used in this document. [Figure 1](#) shows the power supply circuit.

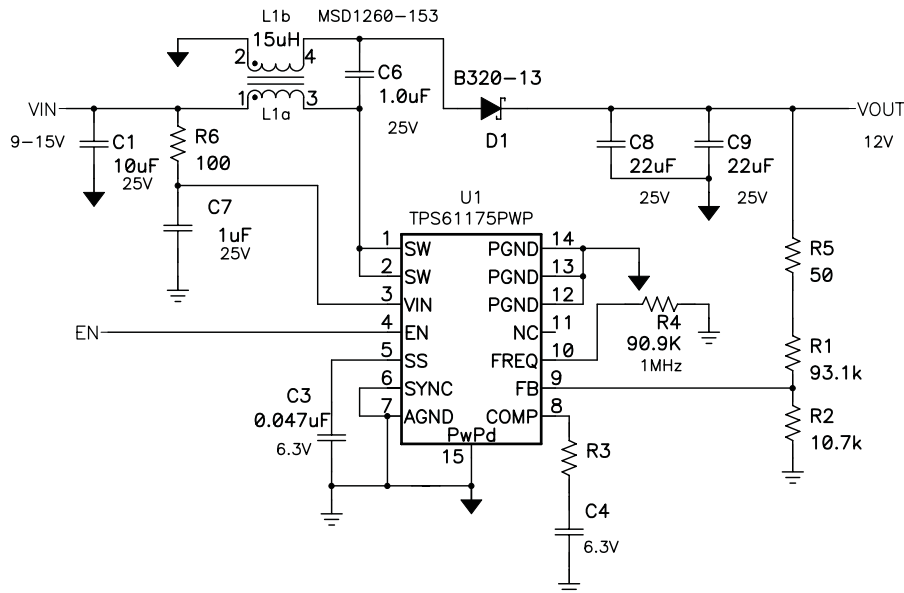

Note: This schematic excludes the reference designators of open components on the PR894E–1 PCB.

Figure 1. 12-V Power Supply From 9-V to 15-V Input Power Source

[Table 1](#) gives the performance specifications for the reference design.

Table 1. Performance Specifications for the Reference Design

| PARAMETER | | CONDITIONS | MIN | NOM | MAX | UNIT |
|--|-----------------------|---|------|-----|------|---------------------------|
| INPUT and AMBIENT CHARACTERISTICS | | | | | | |
| V_{IN} | Input voltage | | 9 | 12 | 15 | V |
| f_s | Switching frequency | | | 1 | | MHz |
| T_A | Ambient temperature | | | | 55 | °C |
| OUTPUT CHARACTERISTICS | | | | | | |
| V_{OUT} | Output voltage | | 11.5 | 12 | 12.5 | V |
| | Load regulation | $V_{IN} = 9\text{ V}, 10\text{ mA} < I_O < 800\text{ mA}$ | | | 1% | $\Delta V_O / \Delta I_O$ |
| V_{RIPPLE} | Output voltage ripple | $I_O = 800\text{ mA}$ | | | 100 | mVpp |

Table 1. Performance Specifications for the Reference Design (continued)

| PARAMETER | | CONDITIONS | MIN | NOM | MAX | UNIT |
|-----------------------------------|------------------|----------------|------|-----|-----|------------|
| I_O | Output current | | 1 | | 800 | mA |
| η | Efficiency | $I_O = 800$ mA | | 85% | | |
| TRANSIENT RESPONSE | | | | | | |
| ΔI_{TRAN} | Load step | | | 400 | | mA |
| $\Delta I_{\text{TRAN}}/\Delta t$ | Load slew rate | | 0.20 | | | A/ μ s |
| ΔV_{TRAN} | V_O undershoot | | | 400 | | mV |

1. DUTY CYCLE: Use Equation 1 to estimate the duty cycle.

$$D = \frac{V_{\text{OUT}} + V_D}{V_{\text{IN}} + V_{\text{OUT}} + V_D} \quad (1)$$

$D_{\text{MAX}} = 0.58$ occurs at $V_{\text{IN(MIN)}} = 9$ V and $D_{\text{MIN}} = 0.45$ occurs at $V_{\text{IN(MAX)}} = 15$ V.

2. $I_{\text{OUT(MAX)}}$ and $I_{\text{SW(DC)}}$: Use Equation 2 to estimate the maximum average input current.

$$I_{\text{IN(DC)}} = \frac{I_{\text{OUT}}}{\eta_{\text{EST}}} \times \frac{V_{\text{OUT}} + V_D}{V_{\text{IN}}} \quad (2)$$

At $V_{\text{IN(MIN)}} = 9$ V and $\eta_{\text{EST}} = 0.85$, $I_{\text{IN(DC)}} = 1.31$ A while at $V_{\text{IN(MAX)}} = 15$ V and $\eta_{\text{EST}} = 0.90$, $I_{\text{IN(DC)}} = 0.74$ A. Note that in a SEPIC, the switch must handle the current from the input source as well as the output current. So, the maximum average switch current, ignoring inductor current ripple, is 1.31 A + 0.8 A = 2.11 A. Equation 2 ignores the inductor ripple current. But, for stable power supply operation and to minimize EMI, the inductor ripple current, ΔI_L must be no more than a fraction, $K_{\text{IND}} = 20\%$ - 40% of the maximum input current. So, use Equation 3 to estimate the maximum output current for an IC with internal current limit, I_{LIM} , including the effects of ΔI_L . Assuming estimated efficiency $\eta_{\text{est}} = 85\%$ at $V_{\text{IN(MIN)}} = 9$ V and $K_{\text{IND}} = 0.2$,

$$I_{\text{OUT(MAX)}} = \frac{I_{\text{LIM}}}{\left(\frac{V_{\text{OUT}} + V_D}{V_{\text{IN(MIN)}}}\right) \times \left(\frac{1 + K_{\text{IND}}}{\eta_{\text{EST}}}\right) + 1} = \frac{3\text{A}}{\left(\frac{12\text{V} + 0.5\text{V}}{9\text{V}}\right) \times \left(\frac{1 + 30\%}{0.85}\right) + 1} = 0.960\text{A} \quad (3)$$

Equation 3 assumes that both inductors, L_{1a} and L_{1b} , are coupled on the same core. Computing the switch power dissipation was omitted since we are using the IC well below its maximum current and voltage capabilities.

3. INPUT CAPACITANCE (C1): Use the data sheet's recommendation of 10 μ F for the input capacitance. If nonceramic, higher ESR capacitors used, the designer must confirm that the capacitor's ripple current does not exceed that capacitor's ripple current rating as explained in [SLYT309](#).
4. INDUCTANCE (L1a and L1b): From the previous computations where $K_{\text{IND}} = 0.2$ and $I_{\text{IN(DC)}} = 1.31$ A at $V_{\text{IN(MIN)}} = 9$ V, $\Delta I_L = K_{\text{IND}} \times I_{\text{IN(DC)}} = 0.26$ A. After substituting $f_s = 1$ MHz, $V_{\text{IN(MAX)}} = 9$ V, use Equation 4 to get the minimum coupled inductance $L_{1a} = L_{1b}$ required to keep the inductor ripple current less than 20% of the input current.

$$L_{1a} = L_{1b} \geq \frac{1}{2} \times \frac{V_{\text{IN(max)}} \times D_{\text{(min)}}}{\Delta I_{L(15V_{\text{IN}})} \times f_s} = \frac{1}{2} \times \frac{15\text{V} \times 0.45}{0.220\text{A} \times 1\text{MHz}} = 15.3\mu\text{H} \rightarrow 15\mu\text{H} \quad (4)$$

Note if L1a and L1b are closely coupled, the ripple current is divided between them and the required inductance is halved. In account for inductor tolerance, the designer selected the next closest standard value, which is 15 μ H.

When selecting an inductor, the two additional specifications are its DC resistance (DCR) and its current rating, which is the lower of either its saturation current or its current for 40°C temperature rise. For the SEPIC converter with two inductors, choosing a coupled inductor with DCR less than 100 m Ω per winding minimizes these losses. The maximum inductor current per winding occurs at $V_{\text{IN(MIN)}}$ and is $I_{\text{IN(DC)}} + \Delta I_L/2 = 1.31$ A + $0.26/2 = 1.70$ A for L_{1a} and $I_{\text{OUT}} + \Delta I_L = 0.8$ A + 0.26 A/2 = 0.93 A for L_{1b} . Adding 20% for inductor current ripple spikes due to load transients, the designer selected MSD1260-153 from Coilcraft, capable of 2.06 A in each winding simultaneously, 2.92 A maximum in a single winding, and 85 -m Ω DCR per winding.

5. OUTPUT CAPACITANCE (C8 and C9): Use Equation 5 and the transient specification to size the output capacitance.

Assuming a ceramic output capacitor with negligible ESR and output ripple specification $V_{\text{RIPPLE}} = 50$ mVpp, Equation 5 recommends that the minimum output capacitance be

$$C_{\text{OUT}} \geq \frac{I_{\text{OUT}} \times D_{(\text{MAX})}}{\Delta V_{\text{RPL}} \times f_{\text{S}}} = \frac{0.8\text{A} \times 0.58}{50\text{mV}_{\text{PP}} \times 1\text{MHz}} = 9.3\mu\text{F} \quad (5)$$

To meet the load transient specification and assuming a control loop bandwidth $f_{\text{BW}} = 5$ kHz, Equation 6 gives

$$C_{\text{OUT}} \geq \frac{\Delta I_{\text{TRAN}}}{2\pi \times f_{\text{BW}} \times \Delta V_{\text{TRAN}}} = \frac{0.4\text{A}}{2\pi \times 5\text{KHz} \times 400\text{mV}} = 32\mu\text{F} \quad (6)$$

The loop bandwidth assumption of 5 kHz may have to be modified later. The designer selected C2 = 2 × 22 μF, 50-V output capacitors instead of one 47-μF capacitor because the resonance frequency of most 47-μF capacitors is above the 1-MHz switching frequency. If capacitors with higher ESRs than those of ceramic capacitors are used, the designer must include the effect of the ESR when sizing the output capacitor for the specified ripple but also confirm that the capacitor ripple current does not exceed that capacitor's ripple current rating as explained in [SLYT309](#).

6. SERIES CAPACITOR (C6): Knowing that $I_{\text{L1b}} = I_{\text{OUT}}$ flows into C_{p} during the on time, it is recommended to choose C_{p} so that its ripple ΔV_{Cp} is no more than 5% of $V_{\text{Cp(DC)}} = V_{\text{IN}}$. The worst case occurs at $V_{\text{IN(MAX)}}$. Use Equation 7 to compute the minimum capacitor assuming $\Delta V_{\text{Cp}} = 5\% \times V_{\text{IN(MAX)}} = 0.75$ V.

$$C_6 \geq \frac{I_{\text{OUT}} \times D_{(\text{MAX})}}{\Delta V_{\text{Cp-PKPK}} \times f_{\text{S}}} = \frac{0.8\text{A} \times 0.45}{0.75\text{V}_{\text{PKPK}} \times 1\text{MHz}} = 0.48\mu\text{F} \quad (7)$$

7. SOFT START CAPACITOR (C3): Use the data sheet's recommendation of 0.047 μF for the soft start capacitor. Increasing this value slows down the output voltage's rise time and also minimizes in-rush current.
8. SCHOTTKY DIODE (D1): Even with an ideal printed-circuit board layout containing short traces to minimize stray inductance and capacitance, the switching node of the boost converter may exhibit ringing up to 30% higher than the output voltage. Therefore, the designer selected a 20-V-rated diode to accommodate such ringing. The designer also selected a diode with a thermal rating that is high enough to accommodate its power dissipation, which is approximately $P_{\text{D(DIODE)}} = I_{\text{OUT}} \times V_{\text{f}} = 800$ mA × 0.5 V = 400 mW.
9. FEEDBACK RESISTORS (R1 and R2): The data sheet recommends 10 kΩ as an optimum value for R2. Larger or smaller values can be used at the risk of noise being injected into FB or higher current lost through the FB resistors, respectively. After first trying 10 kΩ, the designer selected R2 = 10.7 kΩ so that R1 computes closer to a standard resistor value per Equation 8:

$$R1 = R2 \times \left(\frac{V_{\text{OUT}}}{1.229\text{V}} - 1 \right) = 10.7\text{k}\Omega \times \left(\frac{12\text{V}}{1.229\text{V}} - 1 \right) = 93.7\text{k}\Omega \rightarrow 93.1\text{k}\Omega \quad (8)$$

10. SWITCHING FREQUENCY RESISTOR (R4): Use data sheet Figure 13 to properly size the resistor for $f_{\text{S}} = 1$ MHz. Higher switching frequencies allow for lower valued, and therefore potentially smaller packaged, inductors at the expense of higher switching losses and lower efficiency.
11. COMPENSATING THE CONTROL LOOP (R3 and C4): As summarized in Dr. Ray Ridley's article⁽¹⁾, the mathematical model for the SEPIC converter is extremely complicated. Therefore, when using a current-mode controlled converter with a transconductance amplifier like the TPS61175, it is easier and faster to compensate the loop by inspection of the duty cycle to output (i.e., power stage or plant) transfer function. This transfer function can be obtained from either simulated data using a Spice model as explained in Dr. Ridley's article or measured data. To obtain the measured data, a Venable or equivalent gain/phase analyzer is necessary. After designing the converter using the previous steps, use a large compensation capacitor (e.g., C4 = 1 μF) and nominal compensation resistor (e.g., R3 = 1 kΩ) to roll off the control loop at a very low frequency and then measure the power stage transfer function. Figure 2 shows measured results from the power stage transfer function's gain and phase at full load for $V_{\text{IN(MIN)}}$, in red and royal blue, and $V_{\text{IN(MAX)}}$, in maroon and dark blue, respectively.

⁽¹⁾ Ray Ridley, Designer's Series, Part V: Current-Mode Control Modeling. *Switching Power Magazine*, 2006, [Online]. <http://www.switchingpowermagazine.com/downloads/5%20Current%20Mode%20Control%20Modeling.pdf>

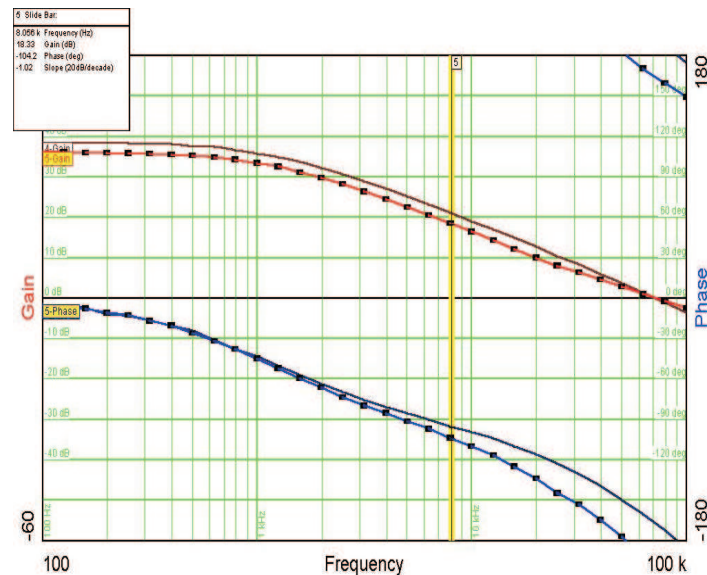

Figure 2. Measured Power Stage Gain and Phase With R3 = 1 kΩ and C4 = 1 μF

Dr. Ridley¹ writes that there are three RHP zeroes with two of those being complex. Equation 9 computes the lowest frequency RHP zero, which occurs at $V_{IN(MIN)}$.

$$f_{RHPZ} = \frac{1}{2\pi \times \frac{L_{1a}}{R_{OUT}} \times \left(\frac{D}{1-D}\right)^2} = \frac{1}{2\pi \times \frac{15\mu\text{H}}{15\Omega} \times \left(\frac{0.58}{1-0.58}\right)^2} = 83.5\text{kHz} \quad (9)$$

To prevent switching noise or gain fluctuations due to changes in nonmeasured parameters from causing small signal instability, conventional wisdom is for the crossover frequency, f_{BW} , to be kept below $f_{RHPZ}/10 \Rightarrow X$ 8 kHz in order to avoid the effects of the RHPZ on the control loop. Therefore, the compensation gain, K_{COMP} , and power stage gain at the 8-kHz crossover frequency must be 0 dB, or $K_{COMP}(f_{BW}) + 20\log(G_{PW}(f_{BW})) = 0$ dB, so $K_{COMP}(f_{BW}) = -20\log(G_{PW}(f_{BW})) = -18.33$ dB as illustrated by the yellow line in Figure 2. Using Type II compensation and finding $G_{EAMAX} = 440 \mu\text{mho}$ in the data sheet, Equation 10 computes the value of R3 to give $K_{COMP}(f_{BW}) = -18.33$ dB, rounded up to the closest standard value.

$$R3 \cong \frac{10^{\frac{K_{COMP}(f_c)}{20\text{dB}}}}{G_{EA(MAX)} \times \frac{R2}{R2 + R1}} = \frac{10^{\frac{-18.33\text{dB}}{20\text{dB}}}}{440\mu\text{mho} \times \frac{10.7\text{k}\Omega}{93.1\text{k}\Omega + 10.7\text{k}\Omega}} = 2.69\text{k}\Omega \quad (10)$$

The compensation zero, f_z , is typically set between 1/5 and 1/10 of f_{BW} in order to maximize its phase boost at the crossover frequency. The designer set the $f_z \sim f_{BW}/5 = 1.6$ kHz and solved for C4. The answer was rounded down to the closest standard value.

$$C4 \cong \frac{1}{2\pi \times R3 \times f_z} = \frac{1}{2\pi \times 2.67\text{k}\Omega \times 1600\text{Hz}} = 0.037\mu\text{F} \rightarrow 0.039\mu\text{F} \quad (11)$$

Figure 3 shows the measured loop gain and phase. As designed for $V_{IN(MIN)}$, the measured f_{BW} is slightly higher than 8 kHz and the phase margin is almost 60°.

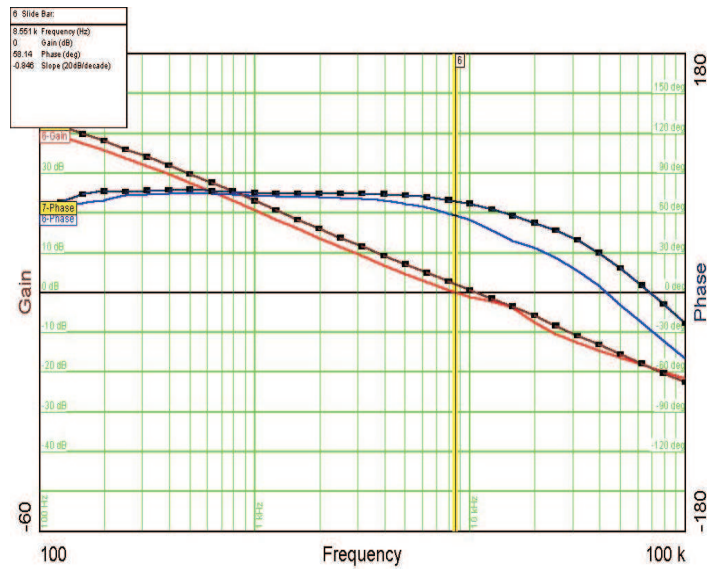

Figure 3. Measured Total Loop Gain and Phase With R3 = 2.67 kΩ and C4 = 0.039 μF

Figure 4 shows the transient response for a 400-mA load step. The ΔV_{TRAN} droop of 320 mV is below the 400-mV design specification.

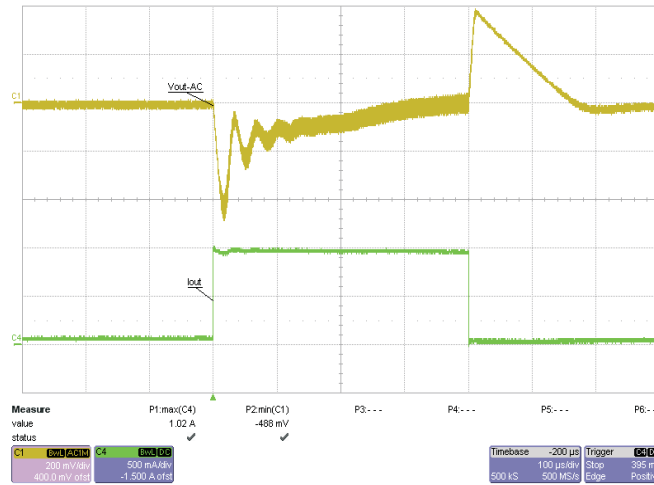

Figure 4. Load Transient Response With $V_{\text{IN}} = 9 \text{ V}$ and $I_{\text{OUT}} = 20 \text{ mA}$ to 400 mA

Figure 5 shows the efficiency.

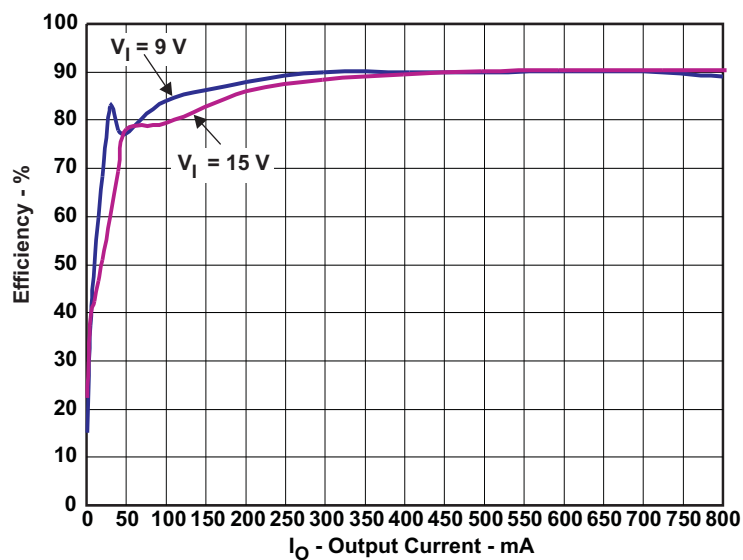

Figure 5. Efficiency

Figure 6 shows the load regulation, which is well within the 1% specification

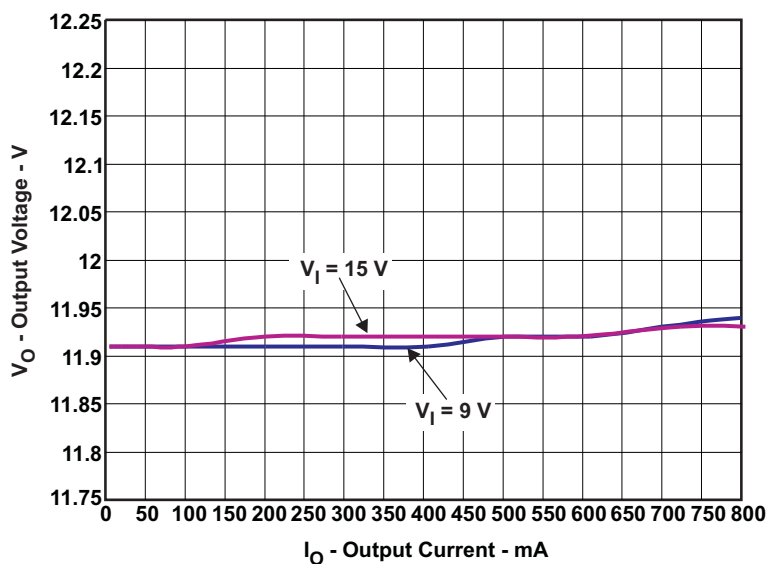

Figure 6. Load Regulation

Figure 7 and Figure 8 show typical operating waveforms.

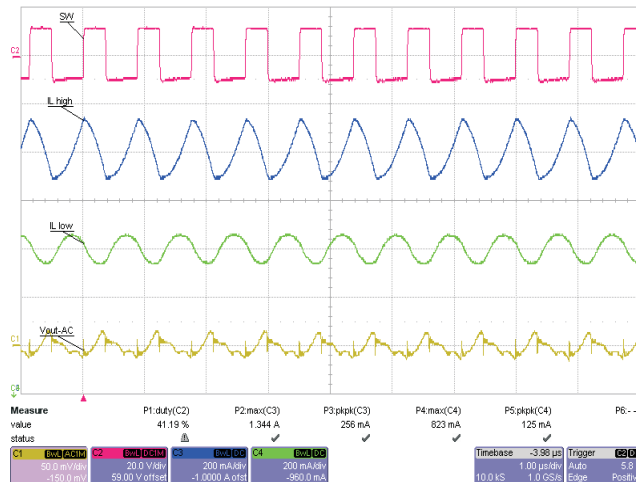

Figure 7. Operation Including V_{RIPPLE} at $V_{IN} = 9\text{ V}$ and $I_{OUT} = 800\text{ mA}$

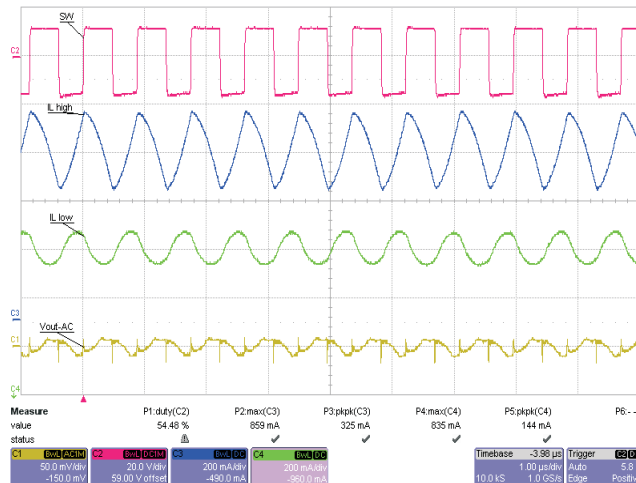

Figure 8. Operation Including V_{RIPPLE} at $V_{IN} = 15\text{ V}$ and $I_{OUT} = 800\text{ mA}$

Figure 9 shows the startup waveform.

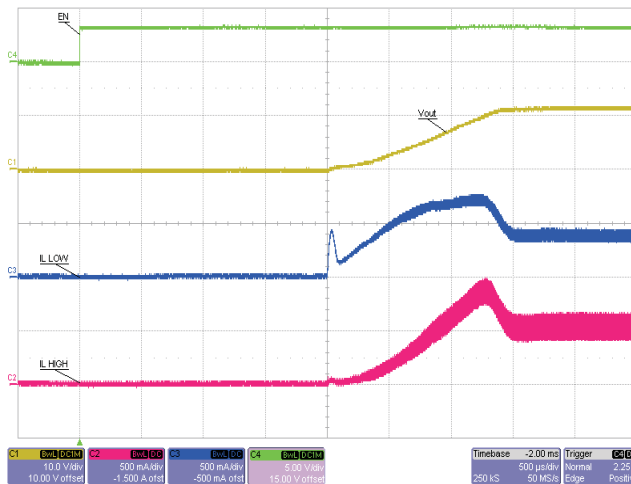

Figure 9. Startup at $V_{IN} = 9\text{ V}$ and $I_{OUT} = 400\text{ mA}$

The preceding design steps are applicable to any current-mode, control-based nonsynchronous boost converter used in a SEPIC configuration.

IMPORTANT NOTICE

Texas Instruments Incorporated and its subsidiaries (TI) reserve the right to make corrections, modifications, enhancements, improvements, and other changes to its products and services at any time and to discontinue any product or service without notice. Customers should obtain the latest relevant information before placing orders and should verify that such information is current and complete. All products are sold subject to TI's terms and conditions of sale supplied at the time of order acknowledgment.

TI warrants performance of its hardware products to the specifications applicable at the time of sale in accordance with TI's standard warranty. Testing and other quality control techniques are used to the extent TI deems necessary to support this warranty. Except where mandated by government requirements, testing of all parameters of each product is not necessarily performed.

TI assumes no liability for applications assistance or customer product design. Customers are responsible for their products and applications using TI components. To minimize the risks associated with customer products and applications, customers should provide adequate design and operating safeguards.

TI does not warrant or represent that any license, either express or implied, is granted under any TI patent right, copyright, mask work right, or other TI intellectual property right relating to any combination, machine, or process in which TI products or services are used. Information published by TI regarding third-party products or services does not constitute a license from TI to use such products or services or a warranty or endorsement thereof. Use of such information may require a license from a third party under the patents or other intellectual property of the third party, or a license from TI under the patents or other intellectual property of TI.

Reproduction of TI information in TI data books or data sheets is permissible only if reproduction is without alteration and is accompanied by all associated warranties, conditions, limitations, and notices. Reproduction of this information with alteration is an unfair and deceptive business practice. TI is not responsible or liable for such altered documentation. Information of third parties may be subject to additional restrictions.

Resale of TI products or services with statements different from or beyond the parameters stated by TI for that product or service voids all express and any implied warranties for the associated TI product or service and is an unfair and deceptive business practice. TI is not responsible or liable for any such statements.

TI products are not authorized for use in safety-critical applications (such as life support) where a failure of the TI product would reasonably be expected to cause severe personal injury or death, unless officers of the parties have executed an agreement specifically governing such use. Buyers represent that they have all necessary expertise in the safety and regulatory ramifications of their applications, and acknowledge and agree that they are solely responsible for all legal, regulatory and safety-related requirements concerning their products and any use of TI products in such safety-critical applications, notwithstanding any applications-related information or support that may be provided by TI. Further, Buyers must fully indemnify TI and its representatives against any damages arising out of the use of TI products in such safety-critical applications.

TI products are neither designed nor intended for use in military/aerospace applications or environments unless the TI products are specifically designated by TI as military-grade or "enhanced plastic." Only products designated by TI as military-grade meet military specifications. Buyers acknowledge and agree that any such use of TI products which TI has not designated as military-grade is solely at the Buyer's risk, and that they are solely responsible for compliance with all legal and regulatory requirements in connection with such use.

TI products are neither designed nor intended for use in automotive applications or environments unless the specific TI products are designated by TI as compliant with ISO/TS 16949 requirements. Buyers acknowledge and agree that, if they use any non-designated products in automotive applications, TI will not be responsible for any failure to meet such requirements.

Following are URLs where you can obtain information on other Texas Instruments products and application solutions:

| Products | | Applications | |
|-----------------------------|--|----------------------------|--|
| Amplifiers | amplifier.ti.com | Audio | www.ti.com/audio |
| Data Converters | dataconverter.ti.com | Automotive | www.ti.com/automotive |
| DLP® Products | www.dlp.com | Communications and Telecom | www.ti.com/communications |
| DSP | dsp.ti.com | Computers and Peripherals | www.ti.com/computers |
| Clocks and Timers | www.ti.com/clocks | Consumer Electronics | www.ti.com/consumer-apps |
| Interface | interface.ti.com | Energy | www.ti.com/energy |
| Logic | logic.ti.com | Industrial | www.ti.com/industrial |
| Power Mgmt | power.ti.com | Medical | www.ti.com/medical |
| Microcontrollers | microcontroller.ti.com | Security | www.ti.com/security |
| RFID | www.ti-rfid.com | Space, Avionics & Defense | www.ti.com/space-avionics-defense |
| RF/IF and ZigBee® Solutions | www.ti.com/lprf | Video and Imaging | www.ti.com/video |
| | | Wireless | www.ti.com/wireless-apps |