

USB Micro Connector

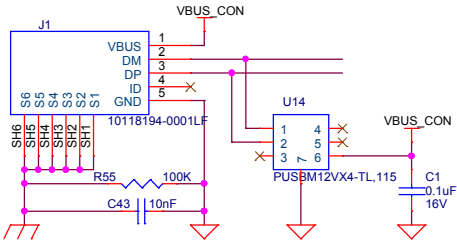

Variable (1.8V - 5V) Regulator

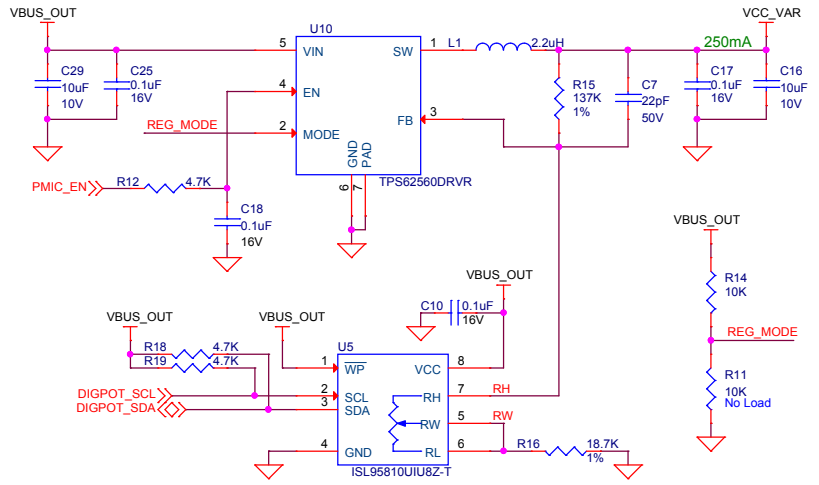

Protection for VBUS

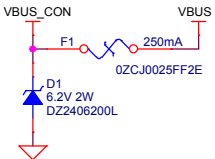

Reverse Protection for VBUS

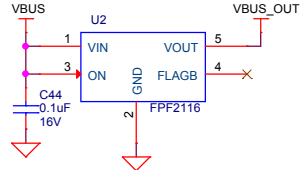

Target Power LED

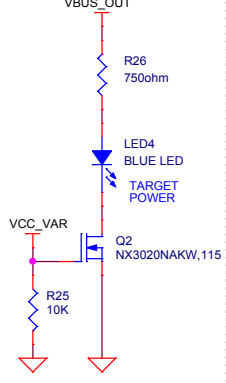

Current Monitoring

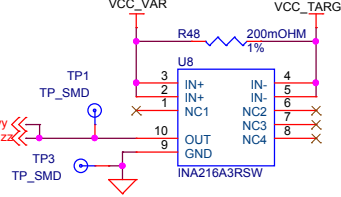

VTARG Enable & Over-Current Protection

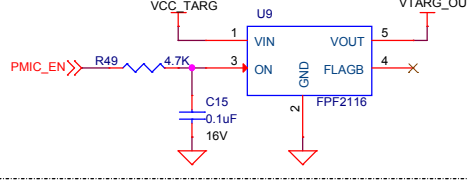

Reverse Protection for Regulator

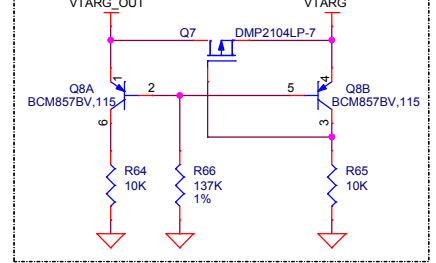

Protection Circuit

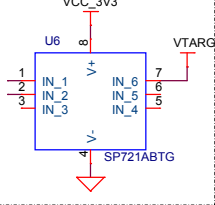

Protection Circuit for VTARG

