

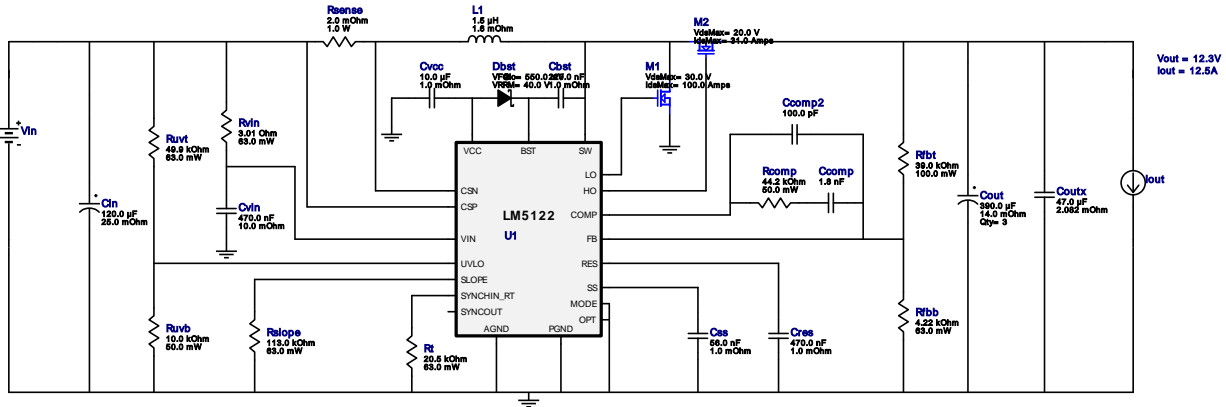





**WEBENCH<sup>®</sup> Design Report**

 Design : 1 LM5122MH/NOPB  
 LM5122MH/NOPB 8.1V-12.3V to 12.30V @ 12.5A

**Electrical BOM**

Name	Manufacturer	Part Number	Properties	Qty	Price	Footprint
Cbst	Kemet	C0603C224Z4VACTU Series= Y5V	Cap= 220.0 nF ESR= 1.0 mOhm VDC= 16.0 V IRMS= 0.0 A	1	\$0.01	0603 5 mm <sup>2</sup>
Ccomp	TDK	C2012C0G1H182K060AA Series= C0G/NP0	Cap= 1.8 nF VDC= 50.0 V IRMS= 0.0 A	1	\$0.04	0805 7 mm <sup>2</sup>
Ccomp2	Samsung Electro-Mechanics	CL21C101JBANNNC Series= C0G/NP0	Cap= 100.0 pF VDC= 50.0 V IRMS= 0.0 A	1	\$0.01	0805 7 mm <sup>2</sup>
Cin	Panasonic	20SPVF120M Series= SVPF	Cap= 120.0 uF ESR= 25.0 mOhm VDC= 20.0 V IRMS= 3.2 A	1	\$0.44	 CAPSMT_62_F61 74 mm <sup>2</sup>
Cout	Panasonic	20SPVF390M Series= SVPF	Cap= 390.0 uF ESR= 14.0 mOhm VDC= 20.0 V IRMS= 4.95 A	3	\$0.65	 CAPSMT_62_E12 106 mm <sup>2</sup>
Coutx	TDK	C3216X5R1E476M160AC Series= X5R	Cap= 47.0 uF ESR= 2.082 mOhm VDC= 25.0 V IRMS= 5.0279 A	1	\$0.39	 1206 11 mm <sup>2</sup>
Cres	Taiyo Yuden	TMK212BJ474KD-T Series= X5R	Cap= 470.0 nF ESR= 1.0 mOhm VDC= 20.0 V IRMS= 0.0 A	1	\$0.02	0805 7 mm <sup>2</sup>
Css	MuRata	GRM155R71A563KA01D Series= X7R	Cap= 56.0 nF ESR= 1.0 mOhm VDC= 10.0 V IRMS= 0.0 A	1	\$0.01	0402 3 mm <sup>2</sup>
Cvcc	Taiyo Yuden	EMK212BJ106KG-T Series= X5R	Cap= 10.0 uF ESR= 1.0 mOhm VDC= 16.0 V IRMS= 0.0 A	1	\$0.03	0805 7 mm <sup>2</sup>

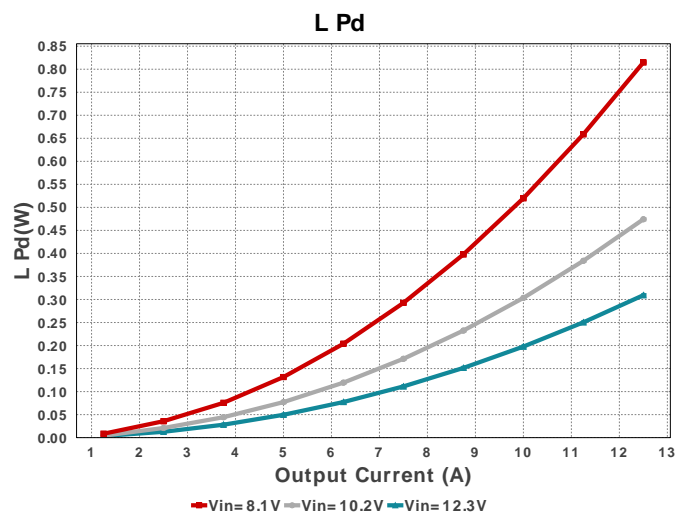
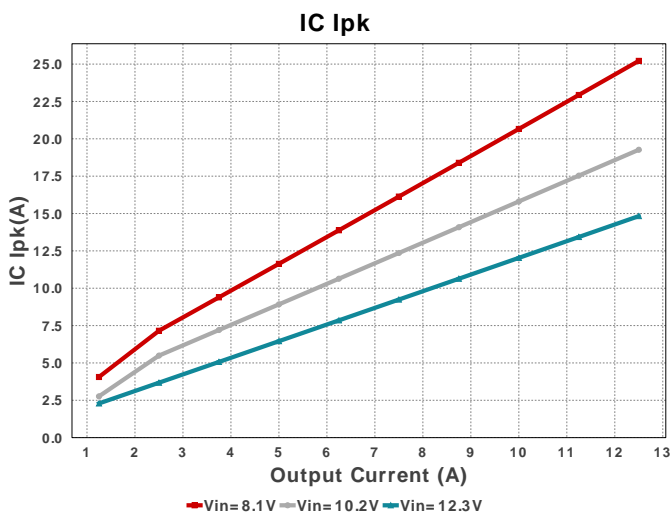
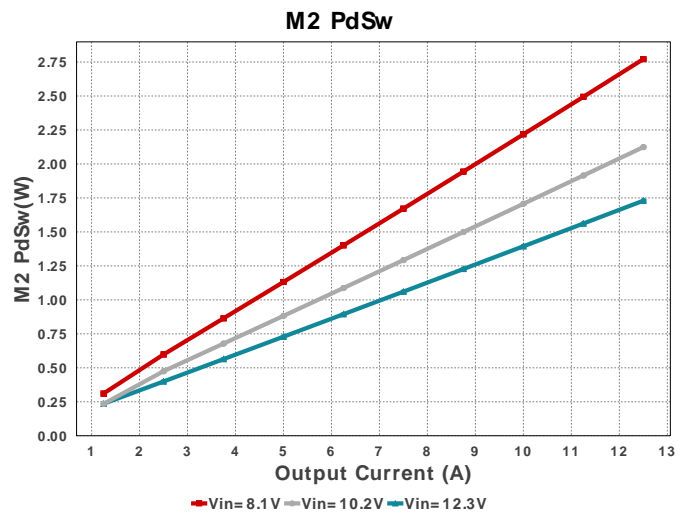
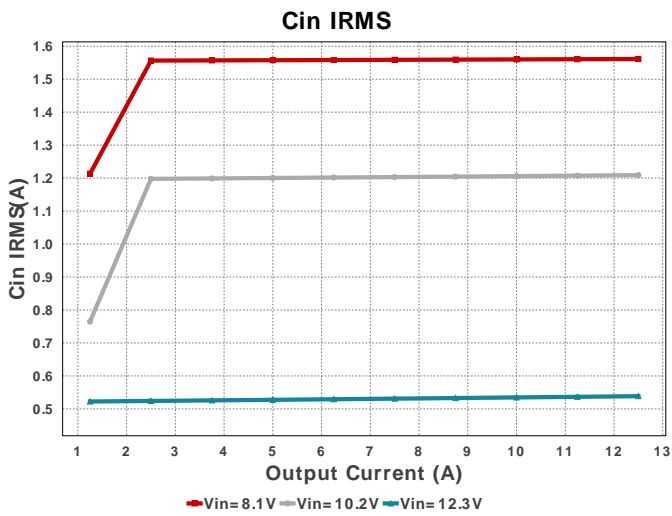
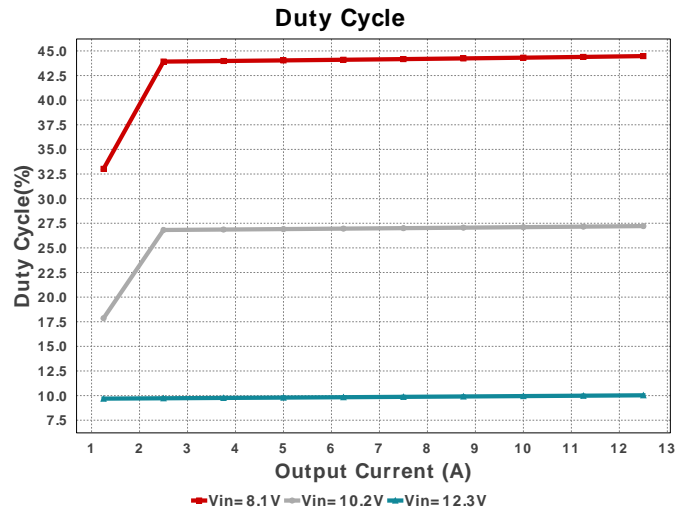
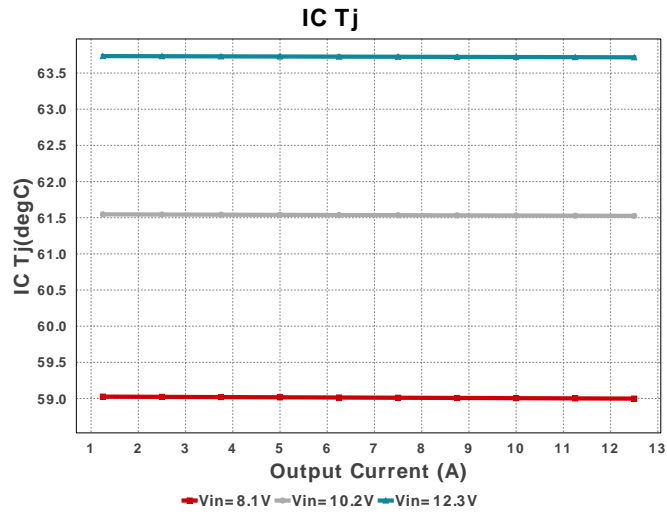
Name	Manufacturer	Part Number	Properties	Qty	Price	Footprint
Cvin	MuRata	GRM188R71C474KA88D Series= X7R	Cap= 470.0 nF ESR= 10.0 mOhm VDC= 16.0 V IRMS= 0.0 A	1	\$0.03	 0603 5 mm <sup>2</sup>
Dbst	Fairchild Semiconductor	SS24FL	VF@Io= 550.0 mV VRRM= 40.0 V	1	\$0.05	 SOD-123F 12 mm <sup>2</sup>
L1	Coilcraft	XAL1010-152MEB	L= 1.5 µH 1.6 mOhm	1	\$1.71	 XAL1010 160 mm <sup>2</sup>
M1	Texas Instruments	CSD17303Q5	VdsMax= 30.0 V IdsMax= 100.0 Amps	1	\$0.56	 TRANS_NexFET_Q5 55 mm <sup>2</sup>
M2	International Rectifier	IRF6609PBF	VdsMax= 20.0 V IdsMax= 31.0 Amps	1	NA	 DirectFET_MT 59 mm <sup>2</sup>
Rcomp	Vishay-Dale	CRCW020144K2FNED Series= ?	Res= 44.2 kOhm Power= 50.0 mW Tolerance= 1.0%	1	\$0.01	 0201 2 mm <sup>2</sup>
Rfbb	Vishay-Dale	CRCW04024K22FKED Series= CRCW..e3	Res= 4.22 kOhm Power= 63.0 mW Tolerance= 1.0%	1	\$0.01	 0402 3 mm <sup>2</sup>
Rfbt	Yageo	RC0603FR-0739KL Series= ?	Res= 39.0 kOhm Power= 100.0 mW Tolerance= 1.0%	1	\$0.01	 0603 5 mm <sup>2</sup>
Rsense	Stackpole Electronics Inc	CSNL1206FT2L00 Series= CSNL	Res= 2.0 mOhm Power= 1.0 W Tolerance= 1.0%	1	\$0.20	 1206 11 mm <sup>2</sup>
Rslope	Vishay-Dale	CRCW0402113KFKED Series= CRCW..e3	Res= 113.0 kOhm Power= 63.0 mW Tolerance= 1.0%	1	\$0.01	 0402 3 mm <sup>2</sup>
Rt	Vishay-Dale	CRCW040220K5FKED Series= CRCW..e3	Res= 20.5 kOhm Power= 63.0 mW Tolerance= 1.0%	1	\$0.01	 0402 3 mm <sup>2</sup>
Ruvb	Yageo	RC0201FR-0710KL Series= ?	Res= 10.0 kOhm Power= 50.0 mW Tolerance= 1.0%	1	\$0.01	 0201 2 mm <sup>2</sup>
Rvvt	Vishay-Dale	CRCW040249K9FKED Series= CRCW..e3	Res= 49.9 kOhm Power= 63.0 mW Tolerance= 1.0%	1	\$0.01	 0402 3 mm <sup>2</sup>
Rvin	Vishay-Dale	CRCW04023R01FKED Series= CRCW..e3	Res= 3.01 Ohm Power= 63.0 mW Tolerance= 1.0%	1	\$0.01	 0402 3 mm <sup>2</sup>
U1	Texas Instruments	LM5122MH/NOPB	Switcher	1	\$1.90	 MXA20A 71 mm <sup>2</sup>

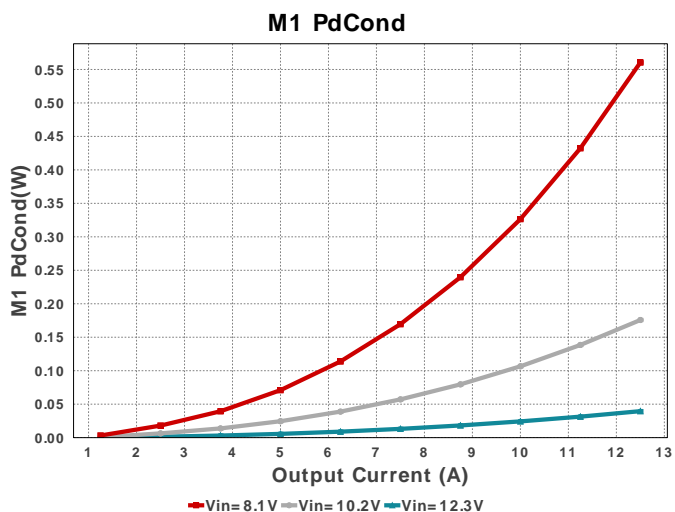
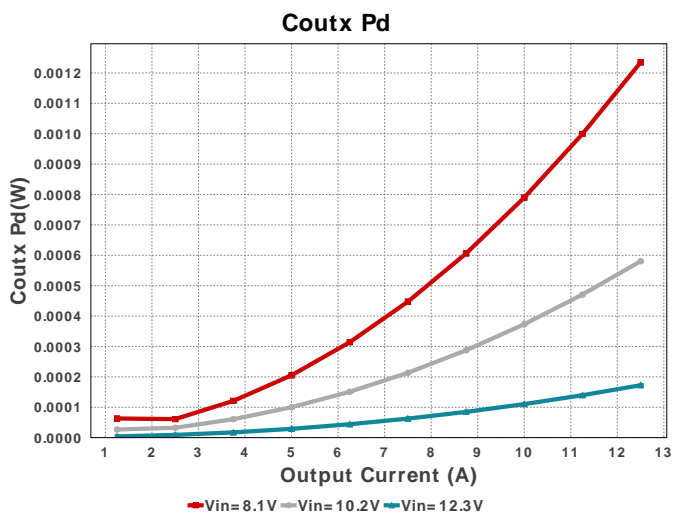
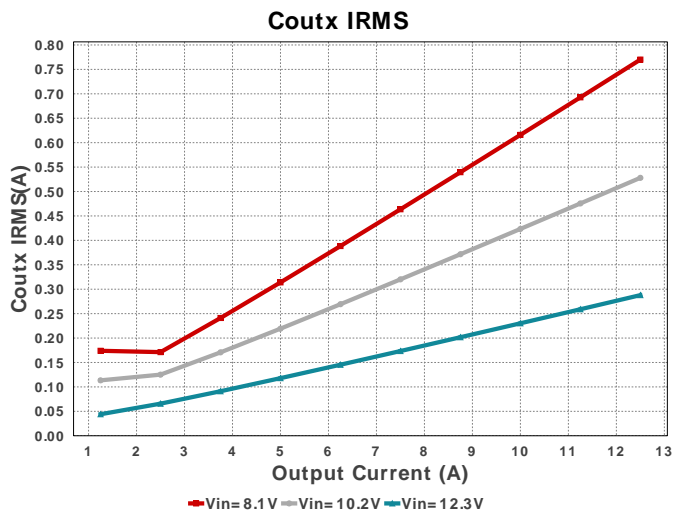
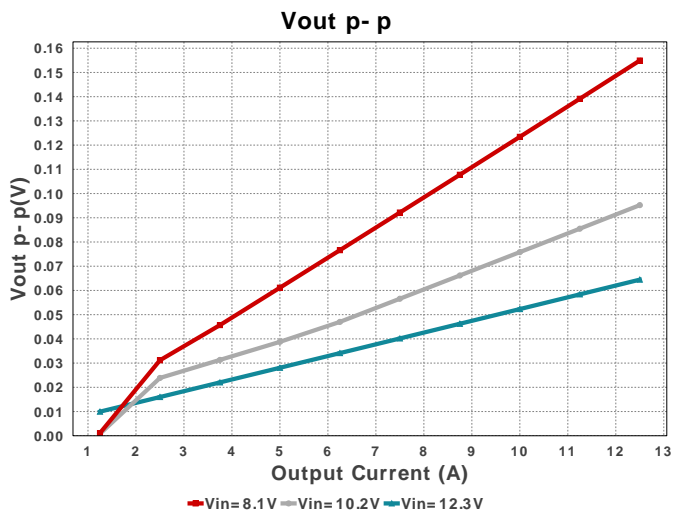
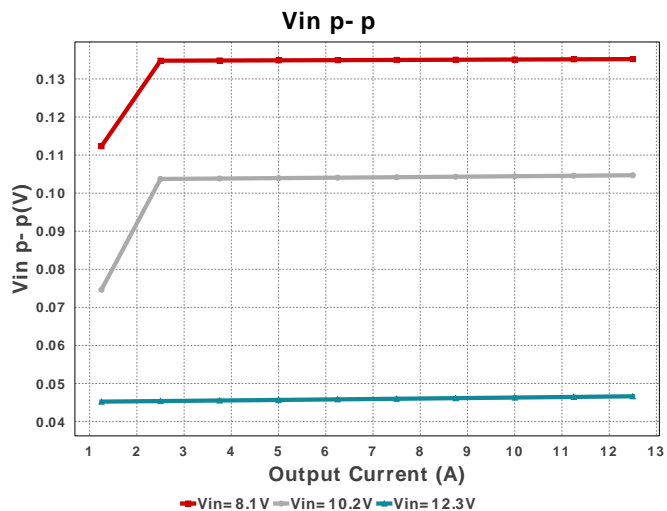
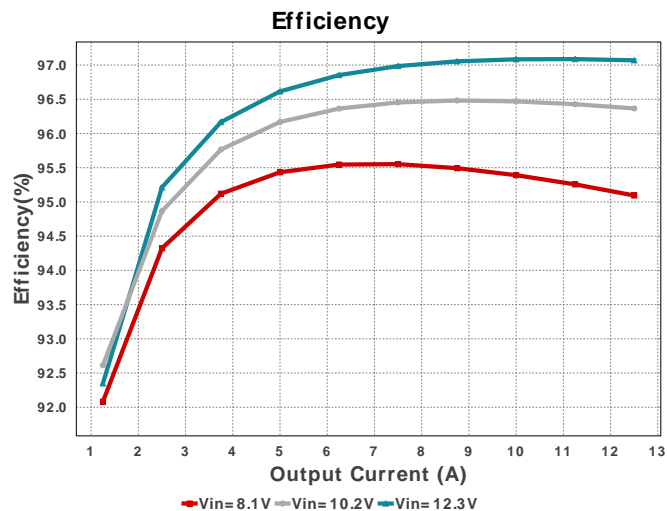

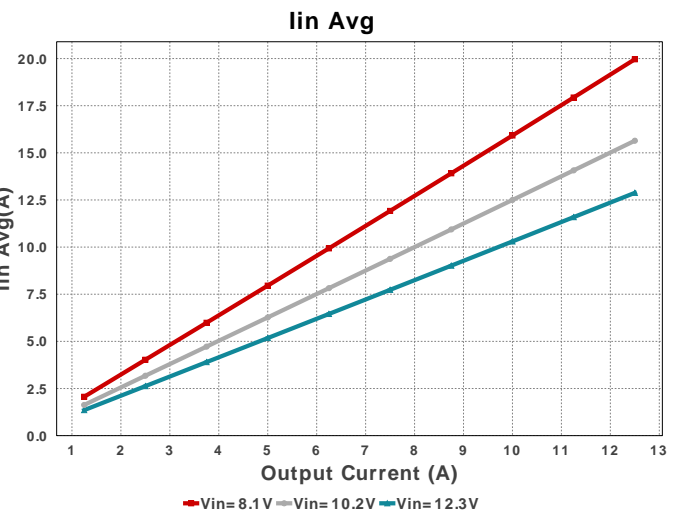
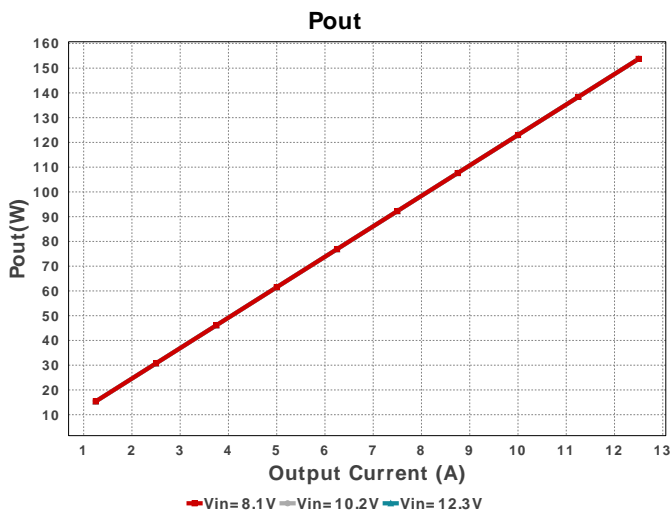
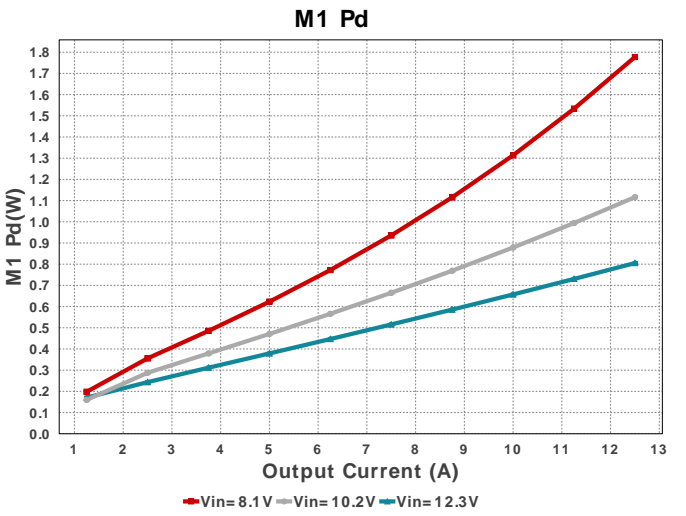
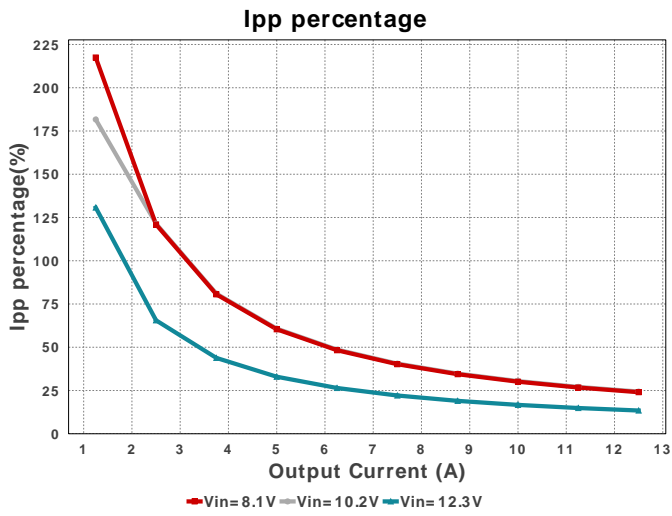
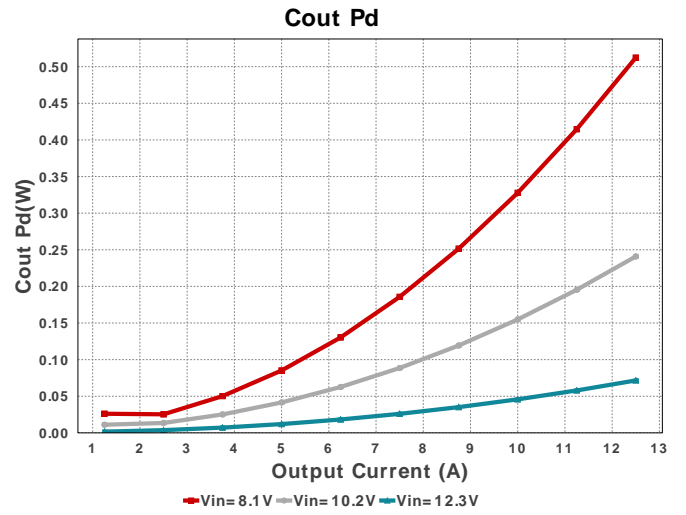
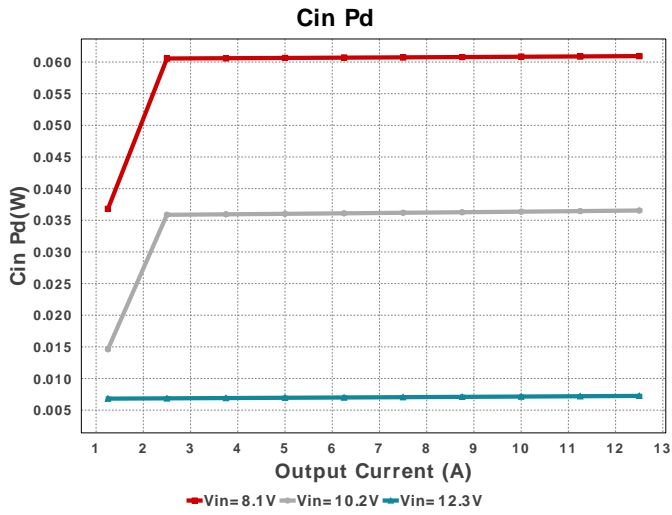



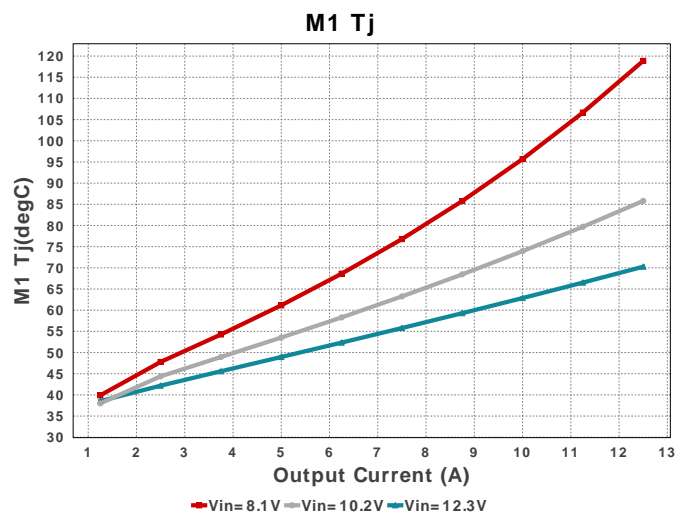
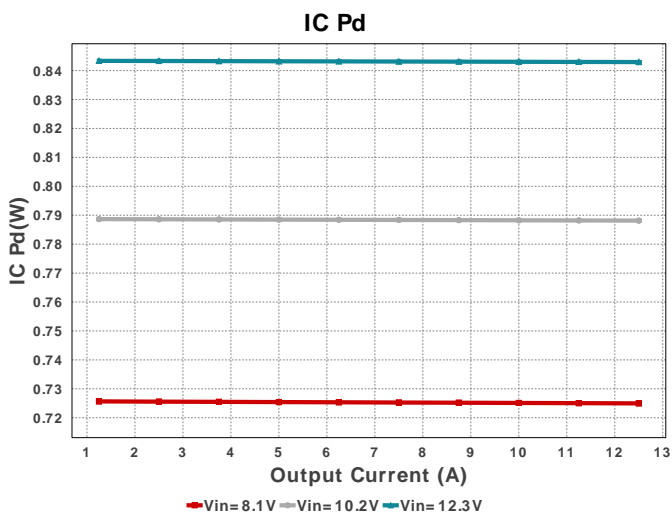
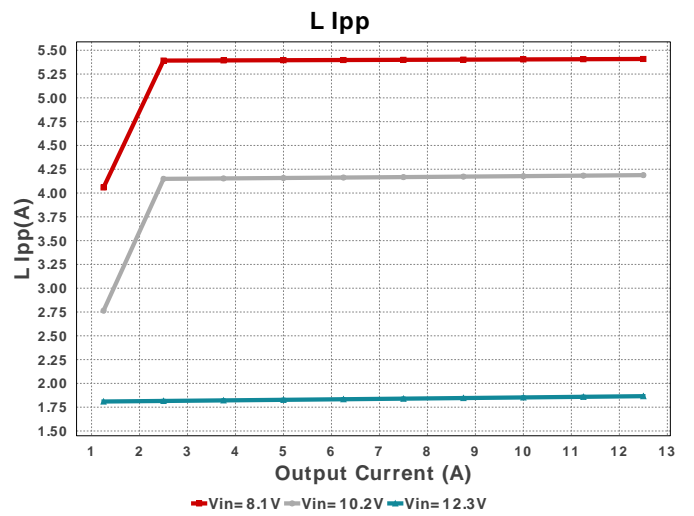
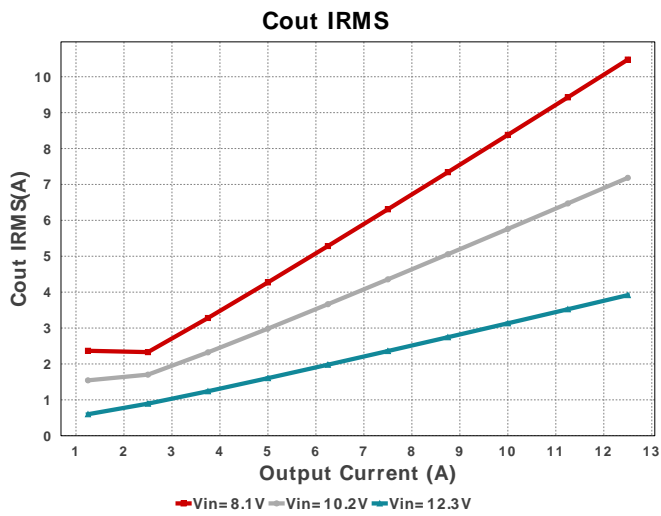
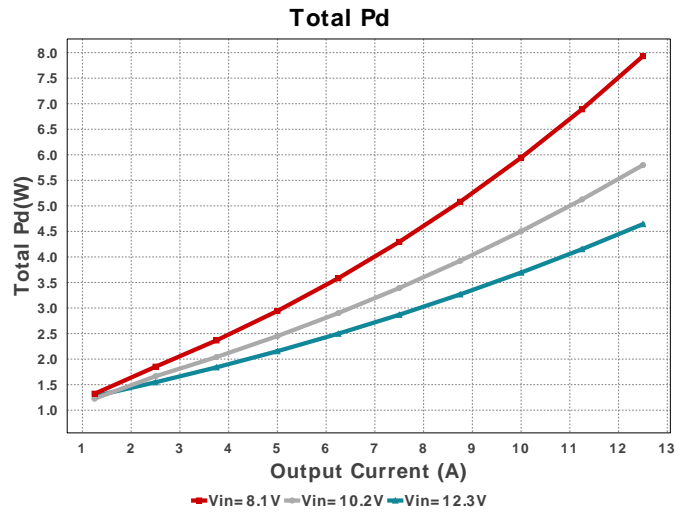
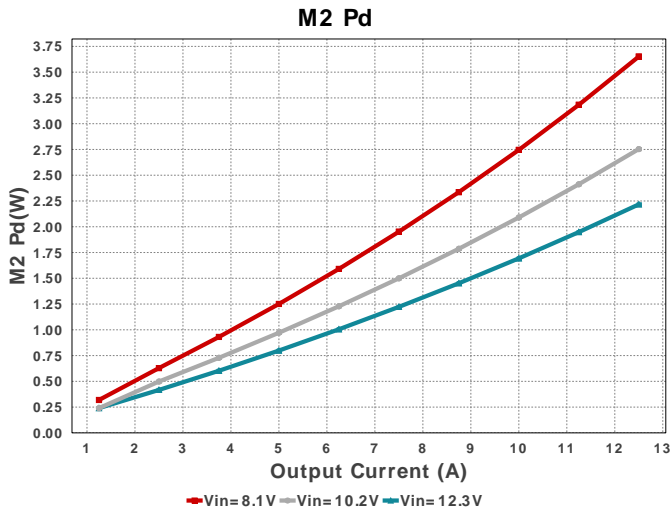

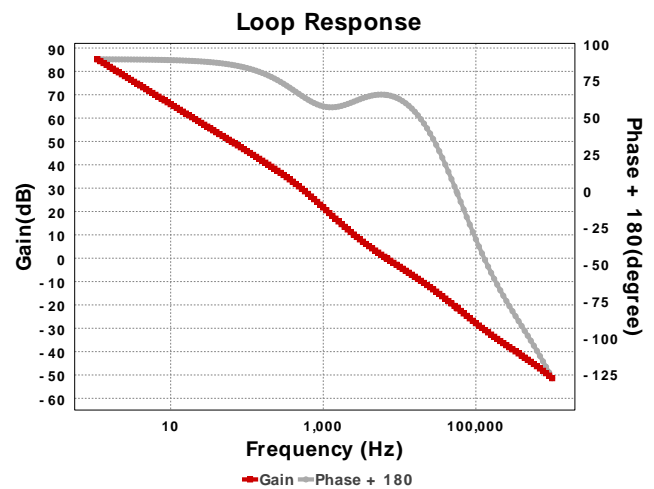
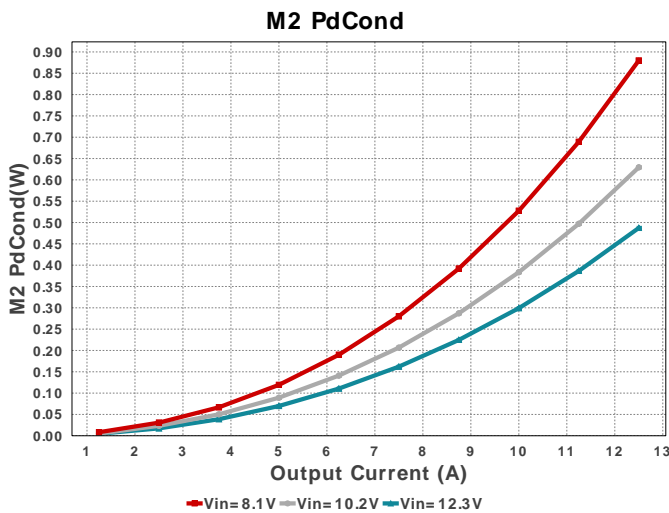
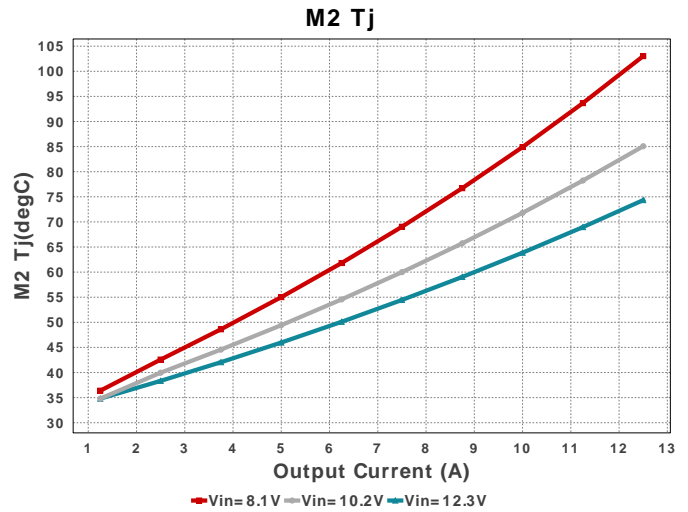
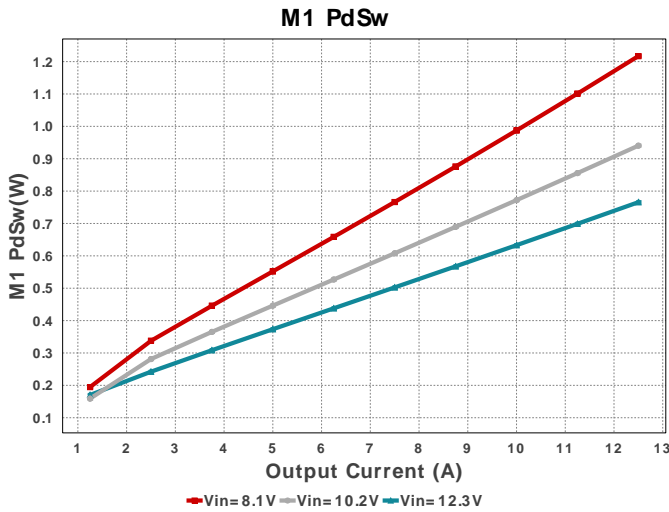

### Operating Values

#	Name	Value	Category	Description
1.	Cin IRMS	1.561 A	Capacitor	Input capacitor RMS ripple current
2.	Cin Pd	60.94 mW	Capacitor	Input capacitor power dissipation
3.	Cout IRMS	10.477 A	Capacitor	Output capacitor RMS ripple current
4.	Cout Pd	512.29 mW	Capacitor	Output capacitor power dissipation
5.	Coutx IRMS	770.058 mA	Capacitor	Output capacitor_x RMS ripple current
6.	Coutx Pd	1.235 mW	Capacitor	Output capacitor_x power loss
7.	IC Ipk	25.216 A	IC	Peak switch current in IC
8.	IC Pd	724.96 mW	IC	IC power dissipation
9.	IC Tj	58.998 degC	IC	IC junction temperature
10.	IC Tolerance	18.0 mV	IC	IC Feedback Tolerance
11.	ICThetaJA	40.0 degC/W	IC	IC junction-to-ambient thermal resistance
12.	Iin Avg	20.038 A	IC	Average input current
13.	Ipp percentage	24.024 %	Inductor	Inductor ripple current percentage (with respect to average inductor current)
14.	L Ipp	5.408 A	Inductor	Peak-to-peak inductor ripple current
15.	L Pd	814.78 mW	Inductor	Inductor power dissipation
16.	M1 Pd	1.777 W	Mosfet	M1 MOSFET total power dissipation
17.	M1 PdCond	560.44 mW	Mosfet	M1 MOSFET conduction losses
18.	M1 PdSw	1.217 W	Mosfet	M1 MOSFET switching losses
19.	M1 Tj	118.87 degC	Mosfet	M1 MOSFET junction temperature
20.	M2 Pd	3.651 W	Mosfet	M2 MOSFET total power dissipation
21.	M2 PdCond	879.86 mW	Mosfet	M2 MOSFET conduction losses
22.	M2 PdSw	2.772 W	Mosfet	M2 MOSFET switching losses
23.	M2 Tj	103.03 degC	Mosfet	M2 MOSFET junction temperature
24.	Cin Pd	60.94 mW	Power	Input capacitor power dissipation
25.	Cout Pd	512.29 mW	Power	Output capacitor power dissipation
26.	Coutx Pd	1.235 mW	Power	Output capacitor_x power loss
27.	IC Pd	724.96 mW	Power	IC power dissipation
28.	L Pd	814.78 mW	Power	Inductor power dissipation
29.	M1 Pd	1.777 W	Power	M1 MOSFET total power dissipation
30.	M1 PdCond	560.44 mW	Power	M1 MOSFET conduction losses
31.	M1 PdSw	1.217 W	Power	M1 MOSFET switching losses

#	Name	Value	Category	Description
32.	M2 Pd	3.651 W	Power	M2 MOSFET total power dissipation
33.	M2 PdCond	879.86 mW	Power	M2 MOSFET conduction losses
34.	M2 PdSw	2.772 W	Power	M2 MOSFET switching losses
35.	Total Pd	8.562 W	Power	Total Power Dissipation
36.	BOM Count	26	System	Total Design BOM count
37.	Cross Freq	4.458 kHz	System Information	Bode plot crossover frequency
38.	Duty Cycle	44.475 %	System Information	Duty cycle
39.	Efficiency	94.725 %	System Information	Steady state efficiency
40.	FootPrint	834.0 mm <sup>2</sup>	System Information	Total Foot Print Area of BOM components
41.	Frequency	439.024 kHz	System Information	Switching frequency
42.	Gain Marg	-16.714 dB	System Information	Bode Plot Gain Margin
43.	Iout	12.5 A	System Information	Iout operating point
44.	Low Freq Gain	86.218 dB	System Information	Gain at 1Hz
45.	Mode	CCM	System Information	Conduction Mode
46.	Phase Marg	60.03 deg	System Information	Bode Plot Phase Margin
47.	Pout	153.75 W	System Information	Total output power
48.	Total BOM	NA	System Information	Total BOM Cost
49.	Vin	8.1 V	System Information	Vin operating point
50.	Vin p-p	135.211 mV	System Information	Peak-to-peak input voltage
51.	Vout	12.3 V	System Information	Operational Output Voltage
52.	Vout Actual	12.29 V	System Information	Vout Actual calculated based on selected voltage divider resistors
53.	Vout Tolerance	3.35 %	System Information	Vout Tolerance based on IC Tolerance (no load) and voltage divider resistors if applicable
54.	Vout p-p	154.924 mV	System Information	Peak-to-peak output ripple voltage

## Design Inputs

Name	Value	Description
Iout	12.5	Maximum Output Current
VinMax	12.3	Maximum input voltage
VinMin	8.1	Minimum input voltage
Vout	12.3	Output Voltage
base_pn	LM5122	Base Product Number
source	DC	Input Source Type
Ta	30.0	Ambient temperature



## WEBENCH® Assembly

### Component Testing

Some published data on components in datasheets such as Capacitor ESR and Inductor DC resistance is based on conservative values that will guarantee that the components always exceed the specification. For design purposes it is usually better to work with typical values. Since this data is not always available it is a good practice to measure the Capacitance and ESR values of  $C_{in}$  and  $C_{out}$ , and the inductance and DC resistance of L1 before assembly of the board. Any large discrepancies in values should be electrically simulated in WEBENCH to check for instabilities and thermally simulated in WebTHERM to make sure critical temperatures are not exceeded.

### Soldering Component to Board

If board assembly is done in house it is best to tack down one terminal of a component on the board then solder the other terminal. For surface mount parts with large tabs, such as the DPAK, the tab on the back of the package should be pre-tinned with solder, then tacked into place by one of the pins. To solder the tab down to the board place the iron down on the board while resting against the tab, heating both surfaces simultaneously. Apply light pressure to the top of the plastic case until the solder flows around the part and the part is flush with the PCB. If the solder is not flowing around the board you may need a higher wattage iron (generally 25W to 30W is enough).

### Initial Startup of Circuit

It is best to initially power up the board by setting the input supply voltage to the lowest operating input voltage 8.1V and set the input supply's current limit to zero. With the input supply off connect up the input supply to  $V_{in}$  and GND. Connect a digital volt meter and a load if needed to set the minimum load of the design from  $V_{out}$  and GND. Turn on the input supply and slowly turn up the current limit on the input supply. If the voltage starts to rise on the input supply continue increasing the input supply current limit while watching the output voltage. If the current increases on the input supply, but the voltage remains near zero, then there may be a short or a component misplaced on the board. Power down the board and visually inspect for solder bridges and recheck the diode and capacitor polarities. Once the power supply circuit is operational then more extensive testing may include full load testing, transient load and line tests to compare with simulation results.

### Load Testing

The setup is the same as the initial startup, except that an additional digital voltmeter is connected between  $V_{in}$  and GND, a load is connected between  $V_{out}$  and GND and a current meter is connected in series between  $V_{out}$  and the load. The load must be able to handle at least rated output power + 50% ( 7.5 watts for this design). Ideally the load is supplied in the form of a variable load test unit. It can also be done in the form of suitably large power resistors. When using an oscilloscope to measure waveforms on the prototype board, the ground leads of the oscilloscope probes should be as short as possible and the area of the loop formed by the ground lead should be kept to a minimum. This will help reduce ground lead inductance and eliminate EMI noise that is not actually present in the circuit.



### Design Assistance

1. The LM5122 is a wide range boost controller which is operable in an ultra wide input range of 4.5 to 65V. A boost regulator can maintain regulation for input voltages lower than the output voltage.
2. Master key : 849EA2C1D0973E3F[v1]
3. **LM5122 Product Folder** : <http://www.ti.com/product/LM5122> : contains the data sheet and other resources.

**Important Notice and Disclaimer**

TI provides technical and reliability data (including datasheets), design resources (including reference designs), application or other design advice, web tools, safety information, and other resources AS IS and with all faults, and disclaims all warranties. These resources are intended for skilled developers designing with TI products. You are solely responsible for (1) selecting the appropriate TI products for your application, (2) designing, validating and testing your application, and (3) ensuring your application meets applicable standards, and any other safety, security, or other requirements.

These resources are subject to change without notice. TI grants you permission to use these resources only for development of an application that uses the TI products described in the resource. Other reproduction and display of these resources is prohibited. No license is granted to any other TI intellectual property right or to any third party intellectual property right. TI disclaims responsibility for, and you will fully indemnify TI and its representatives against, any claims, damages, costs, losses, and liabilities arising out of your use of these resources.

Providing these resources does not expand or otherwise alter TI's applicable Terms of Sale or other applicable terms available either on ti.com or provided in conjunction with TI products.