

WEBENCH® Design Report

Design : 16 TPS546D24RVFR
 TPS546D24RVFR 10.8V-13.2V to 4.00V @ 35A

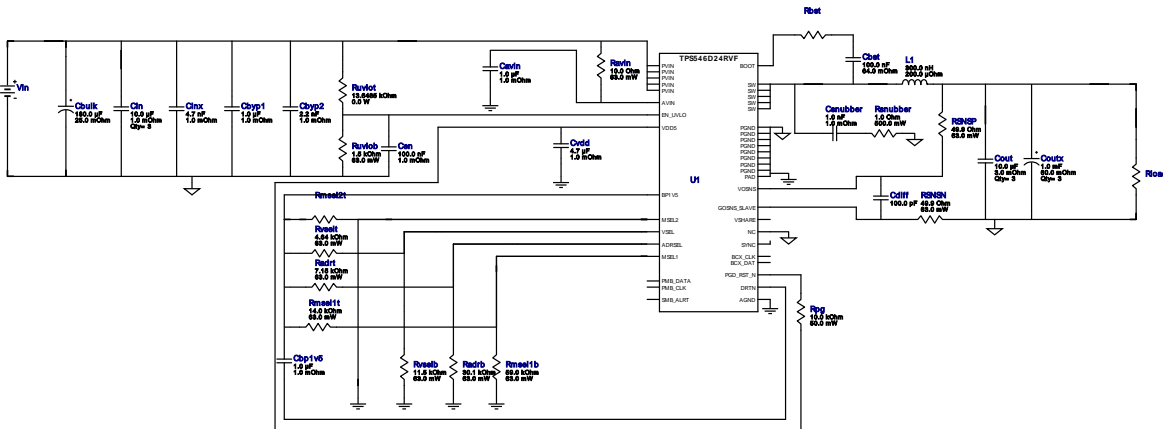

- Do not place Rmsel2t, resistors. Place 0 Ohm resistor for Rbst.

Design Alerts

Component Selection Information

The TPS546D24 is a PMBus(TM) device with key features listed below: PMBus(TM) features marked with * are included in WEBENCH(R) Power Designer. - Adaptive Voltage Scaling (AVS) through VOUT_COMMAND*, - Output voltage and current monitoring, - Thermal Shutdown, - Programmable over current protection, - OCP,OV, UV, OT Levels, - Selectable Internal Compensation*, - Selectable Switching Frequency*, - Turn-On and Turn-Off Delays, - UVLO*, Soft-Start*,OCP* and Soft-Stop. Switching Frequency higher than 1300kHz are disabled on Webench for this input condition, as the junction temperature of the device is exceeding the limit. Use the Advanced Options on the left side to set the PMBus(TM) commands. Please refer to the TPS546D24 datasheet and visit <http://www.ti.com/pmbus> for more information.

Electrical BOM

Name	Manufacturer	Part Number	Properties	Qty	Price	Footprint
Cavin	Taiyo Yuden	TMK212BJ105KG-T Series= X5R	Cap= 1.0 uF ESR= 1.0 mOhm VDC= 25.0 V IRMS= 0.0 A	1	\$0.03	0805 7 mm ²
Cbp1v5	Kemet	C0603C105K8PACTU Series= X5R	Cap= 1.0 uF ESR= 1.0 mOhm VDC= 10.0 V IRMS= 0.0 A	1	\$0.01	0603 5 mm ²
Cbst	Kemet	C0805C104M5RACTU Series= X7R	Cap= 100.0 nF ESR= 64.0 mOhm VDC= 50.0 V IRMS= 1.64 A	1	\$0.01	0805 7 mm ²

Name	Manufacturer	Part Number	Properties	Qty	Price	Footprint
Cbulk	Panasonic	20SVPF180M Series= SVPF	Cap= 180.0 uF ESR= 25.0 mOhm VDC= 20.0 V IRMS= 3.2 A	1	\$0.52	 CAPSMT_62_E7 106 mm ²
Cbyp1	Taiyo Yuden	TMK212BJ105KG-T Series= X5R	Cap= 1.0 uF ESR= 1.0 mOhm VDC= 25.0 V IRMS= 0.0 A	1	\$0.03	 0805 7 mm ²
Cbyp2	MuRata	GRM155R61E222KA01D Series= X5R	Cap= 2.2 nF ESR= 1.0 mOhm VDC= 25.0 V IRMS= 0.0 A	1	\$0.01	 0402 3 mm ²
Cdiff	Kemet	C0201C101K3GACTU Series= C0G/NP0	Cap= 100.0 pF VDC= 10.0 V IRMS= 0.0 A	1	\$0.01	 0201 2 mm ²
Cen	MuRata	GRM155R71A104KA01D Series= X7R	Cap= 100.0 nF ESR= 1.0 mOhm VDC= 10.0 V IRMS= 0.0 A	1	\$0.01	 0402 3 mm ²
Cin	MuRata	GRM32ER71J106KA12L Series= X7R	Cap= 10.0 uF ESR= 1.0 mOhm VDC= 63.0 V IRMS= 6.0 A	3	\$0.30	 1210_280 15 mm ²
Cinx	MuRata	GRM155R71E472KA01D Series= X7R	Cap= 4.7 nF ESR= 1.0 mOhm VDC= 25.0 V IRMS= 0.0 A	1	\$0.01	 0402 3 mm ²
Cout	Kemet	C0805C106K8PACTU Series= X5R	Cap= 10.0 uF ESR= 3.0 mOhm VDC= 10.0 V IRMS= 11.43 A	3	\$0.03	 0805 7 mm ²
Coutx	Panasonic	EEV-FK1E102Q Series= FK	Cap= 1.0 mF ESR= 60.0 mOhm VDC= 25.0 V IRMS= 1.1 A	3	\$0.43	 SM_RADIAL_H13 264 mm ²
Csubber	MuRata	GRM216R71E102KA01D Series= X7R	Cap= 1.0 nF ESR= 1.0 mOhm VDC= 25.0 V IRMS= 0.0 A	1	\$0.01	 0805 7 mm ²
Cvdd	MuRata	GRM155R60J475ME87D Series= X5R	Cap= 4.7 uF ESR= 1.0 mOhm VDC= 6.3 V IRMS= 0.0 A	1	\$0.02	 0402_065 3 mm ²
L1	Coilcraft	SLC1480-301MLB	L= 300.0 nH 200.0 uOhm	1	\$0.78	 SLC1480 231 mm ²
RSNSN	Vishay-Dale	CRCW040249R9FKED Series= CRCW..e3	Res= 49.9 Ohm Power= 63.0 mW Tolerance= 1.0%	1	\$0.01	 0402 3 mm ²
RSNSP	Vishay-Dale	CRCW040249R9FKED Series= CRCW..e3	Res= 49.9 Ohm Power= 63.0 mW Tolerance= 1.0%	1	\$0.01	 0402 3 mm ²
Radrb	Vishay-Dale	CRCW040230K1FKED Series= CRCW..e3	Res= 30.1 kOhm Power= 63.0 mW Tolerance= 1.0%	1	\$0.01	 0402 3 mm ²

Name	Manufacturer	Part Number	Properties	Qty	Price	Footprint
Radrt	Vishay-Dale	CRCW04027K15FKED Series= CRCW..e3	Res= 7.15 kOhm Power= 63.0 mW Tolerance= 1.0%	1	\$0.01	0402 3 mm ²
Ravin	Vishay-Dale	CRCW040210R0FKED Series= CRCW..e3	Res= 10.0 Ohm Power= 63.0 mW Tolerance= 1.0%	1	\$0.01	0402 3 mm ²
Rmsel1b	Vishay-Dale	CRCW040259K0FKED Series= CRCW..e3	Res= 59.0 kOhm Power= 63.0 mW Tolerance= 1.0%	1	\$0.01	0402 3 mm ²
Rmsel1t	Vishay-Dale	CRCW040214K0FKED Series= CRCW..e3	Res= 14.0 kOhm Power= 63.0 mW Tolerance= 1.0%	1	\$0.01	0402 3 mm ²
Rpg	Yageo	RC0201FR-0710KL Series= ?	Res= 10.0 kOhm Power= 50.0 mW Tolerance= 1.0%	1	\$0.01	0201 2 mm ²
Rsnubber	Stackpole Electronics Inc	CSR1206FT1R00 Series= ?	Res= 1.0 Ohm Power= 500.0 mW Tolerance= 1.0%	1	\$0.04	1206 11 mm ²
Ruvlob	Vishay-Dale	CRCW04021K50FKED Series= CRCW..e3	Res= 1.5 kOhm Power= 63.0 mW Tolerance= 1.0%	1	\$0.01	0402 3 mm ²
Ruvlot	CUSTOM	CUSTOM Series= ?	Res= 13.6485 kOhm Power= 0.0 W Tolerance= 0.0%	1	NA	CUSTOM 0 mm ²
Rvselb	Vishay-Dale	CRCW040211K5FKED Series= CRCW..e3	Res= 11.5 kOhm Power= 63.0 mW Tolerance= 1.0%	1	\$0.01	0402 3 mm ²
Rvselt	Vishay-Dale	CRCW04024K64FKED Series= CRCW..e3	Res= 4.64 kOhm Power= 63.0 mW Tolerance= 1.0%	1	\$0.01	0402 3 mm ²
U1	Texas Instruments	TPS546D24RVFR	Switcher	1	\$4.85	RVF0040A 63 mm ²

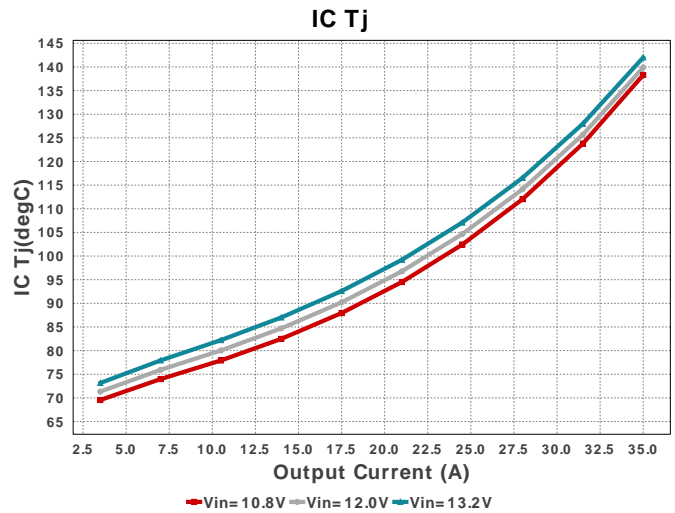
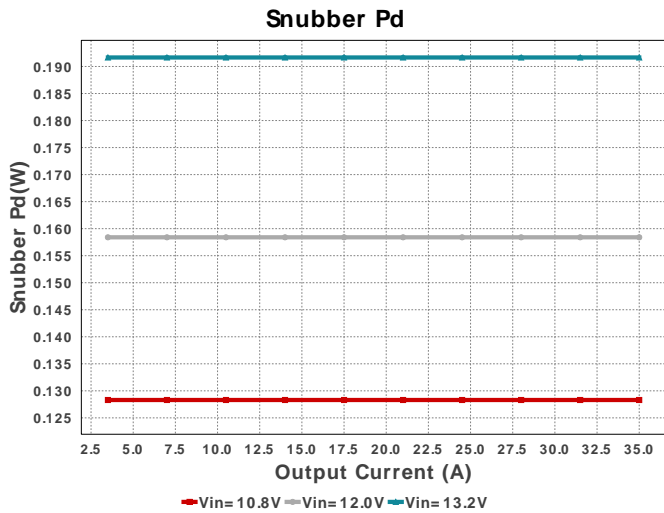

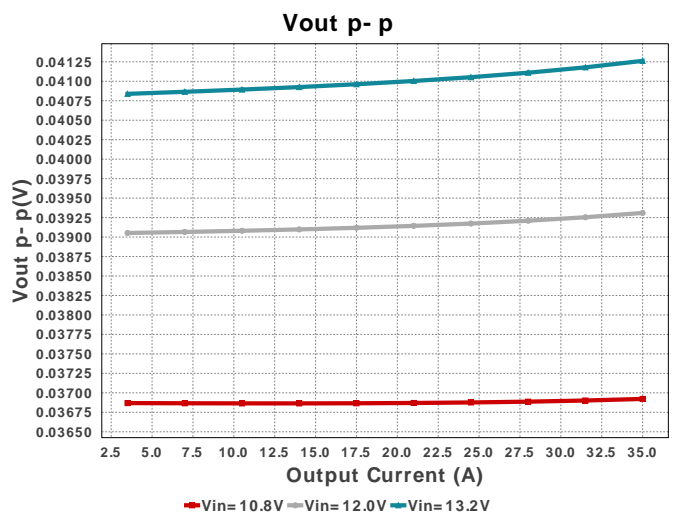
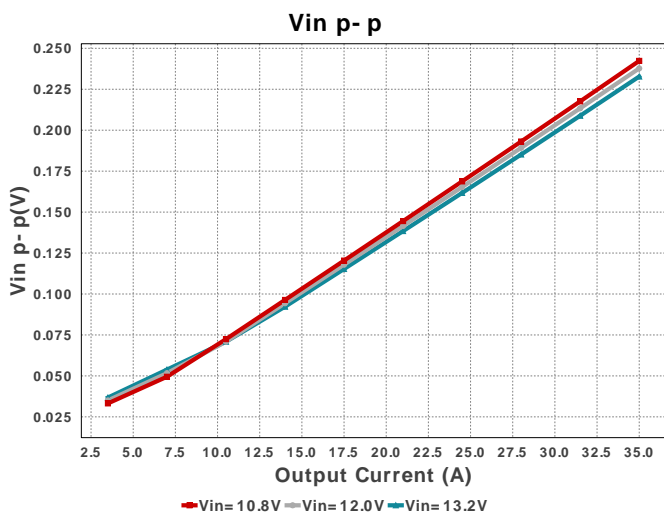
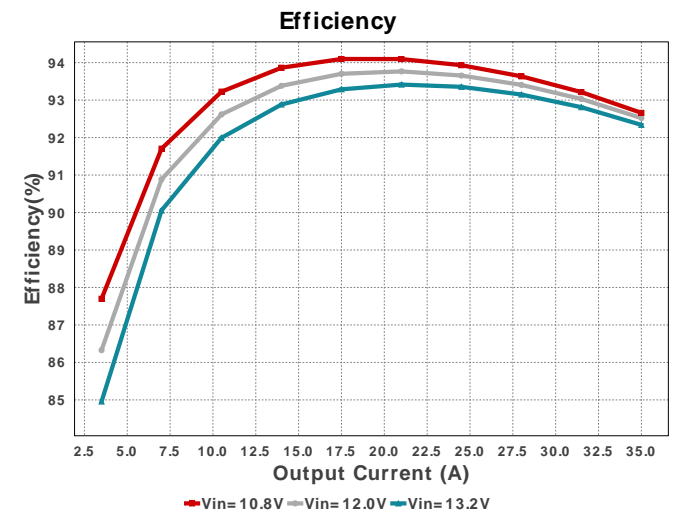
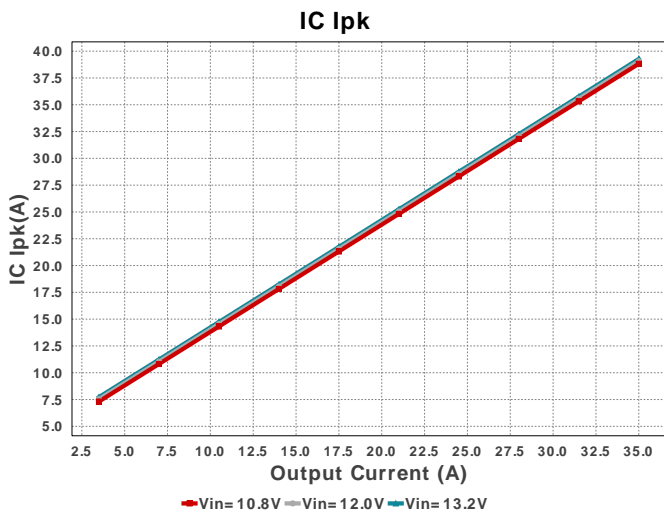
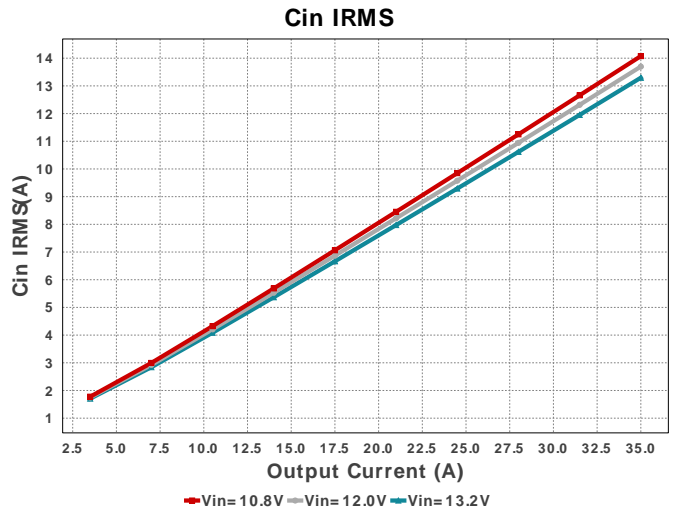
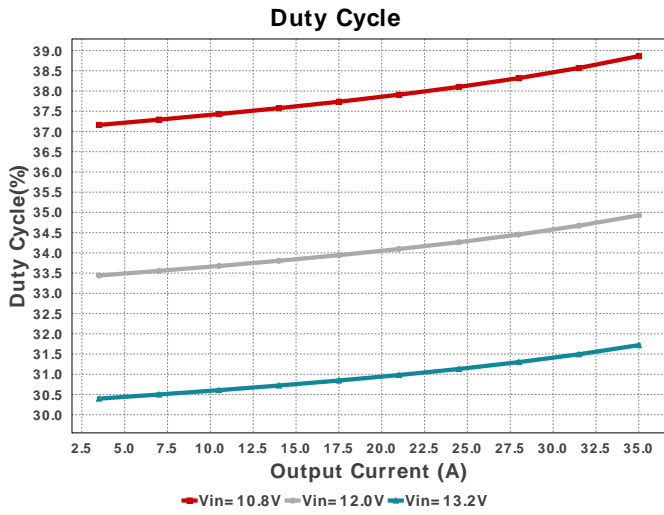

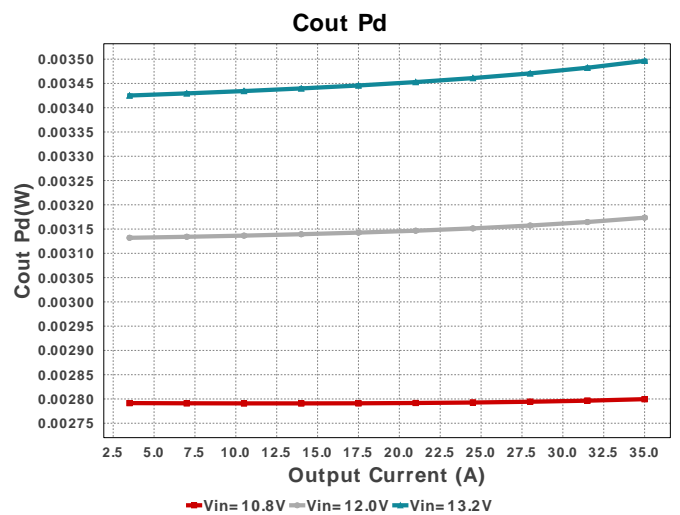
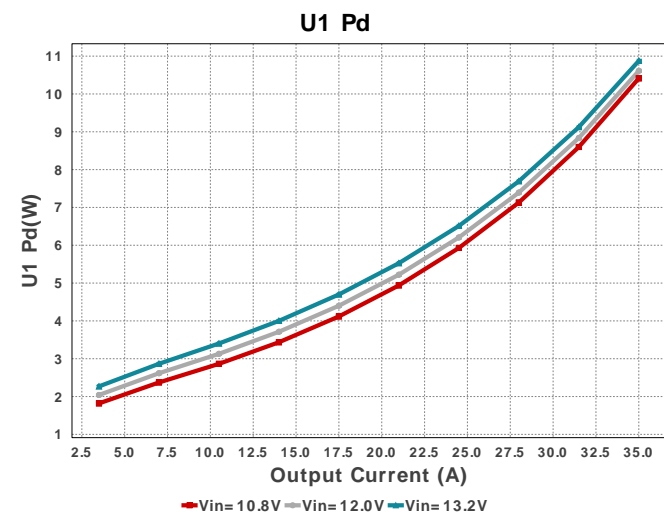
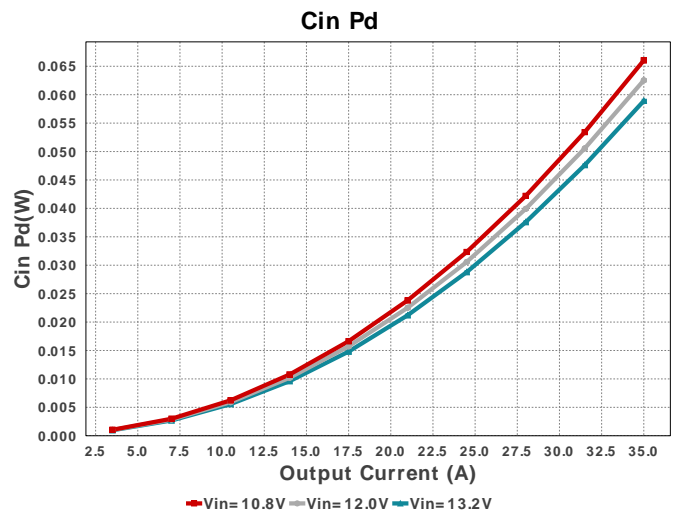
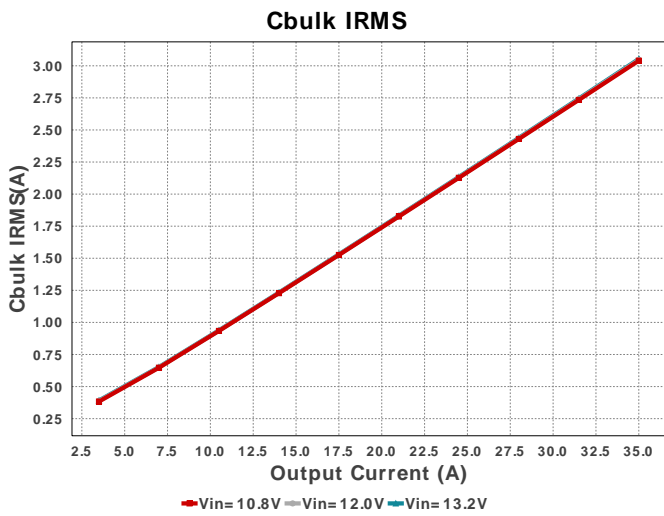
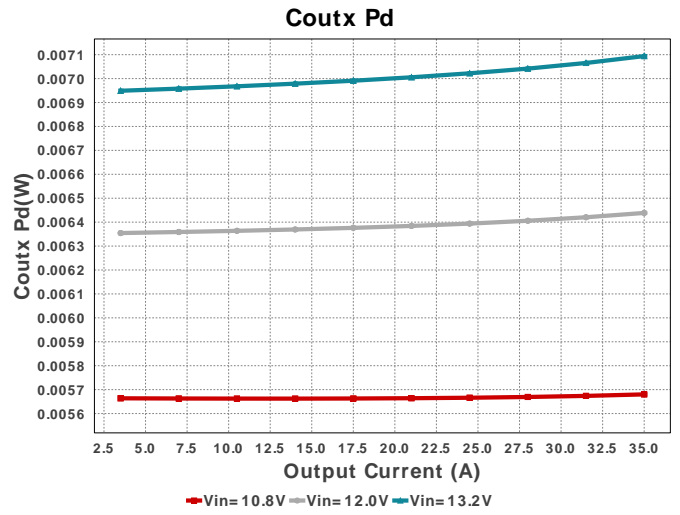
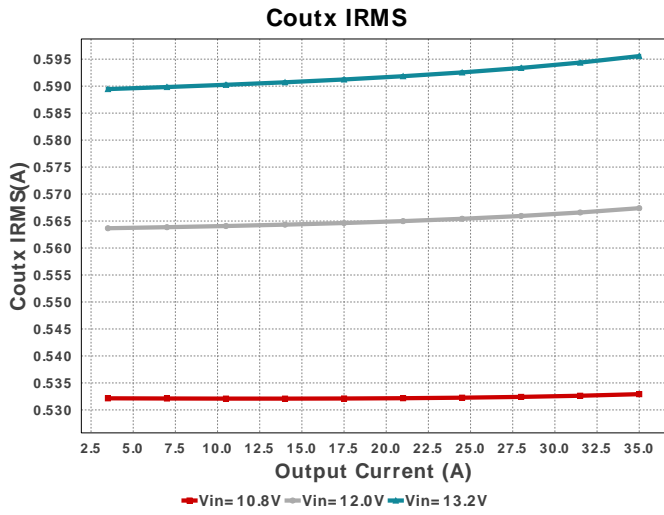

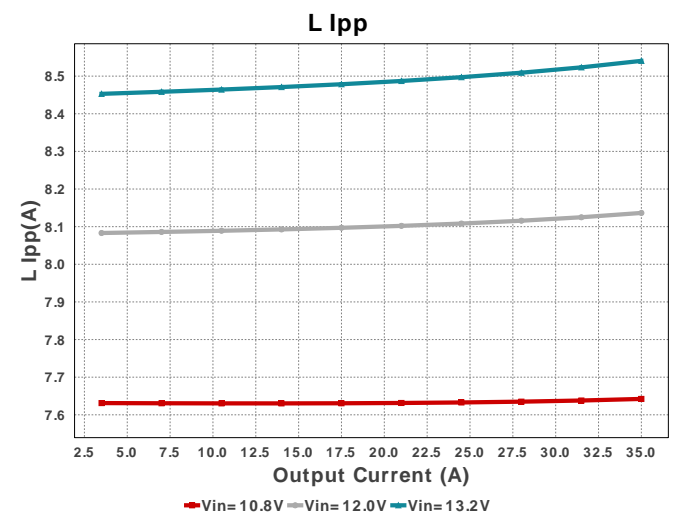
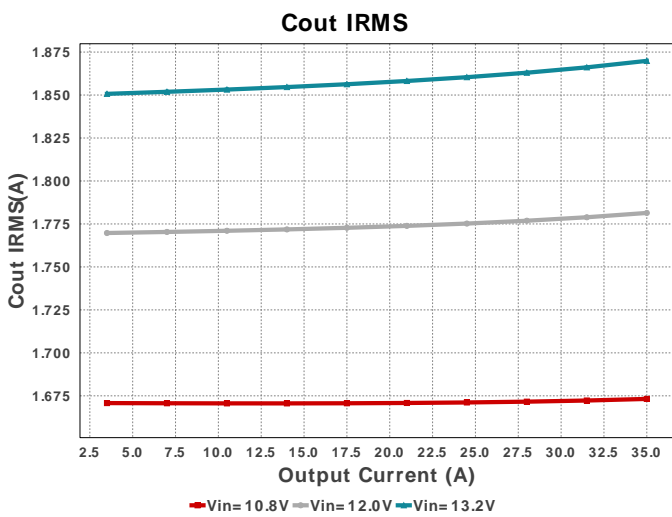
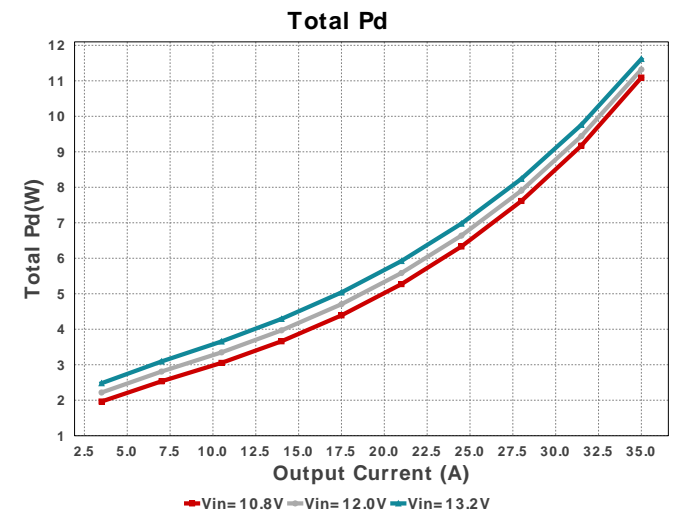
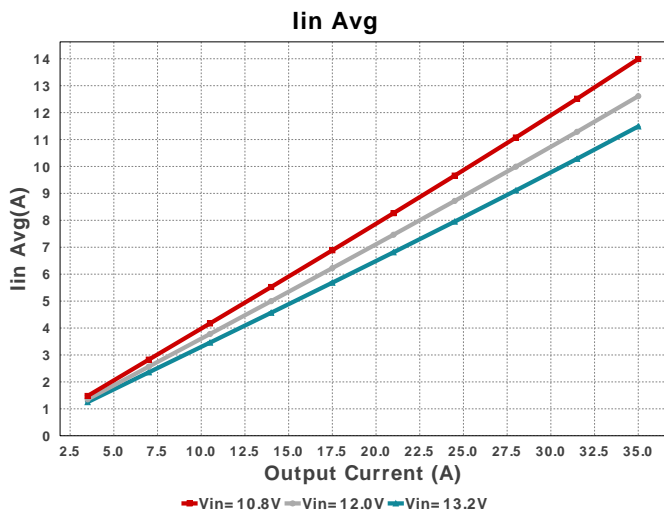
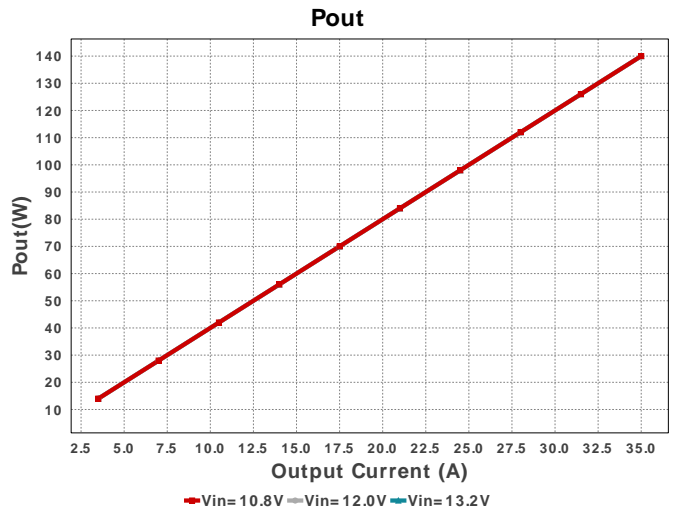
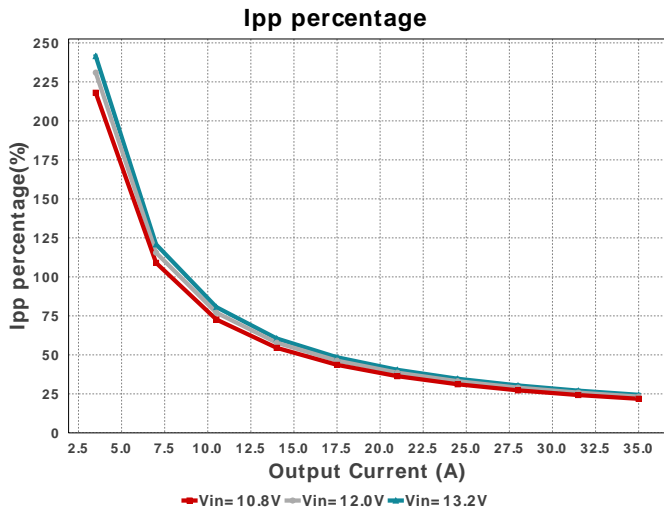

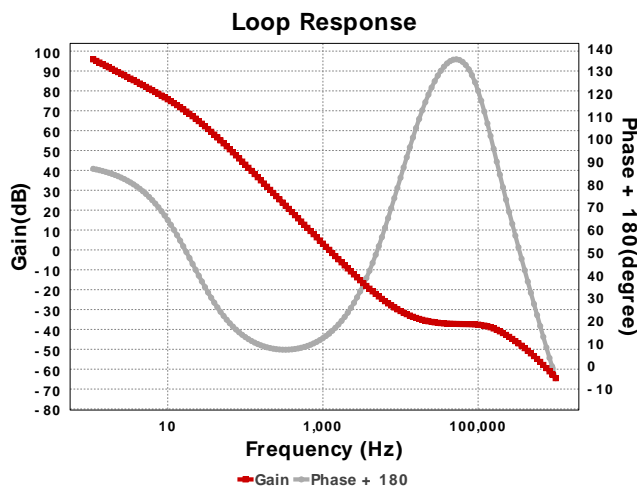
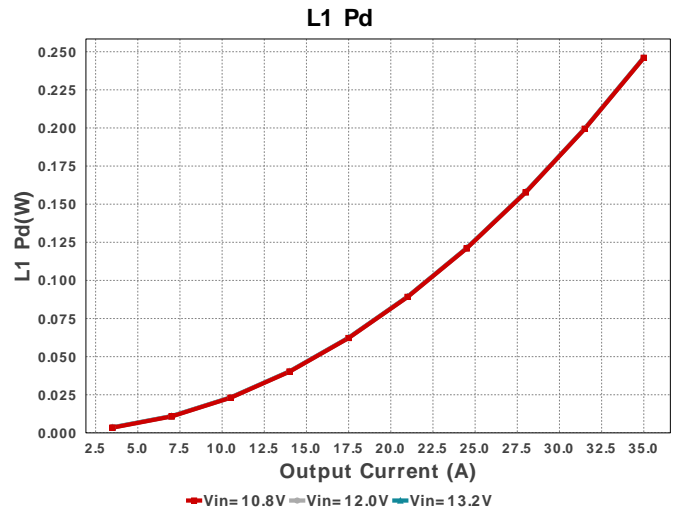
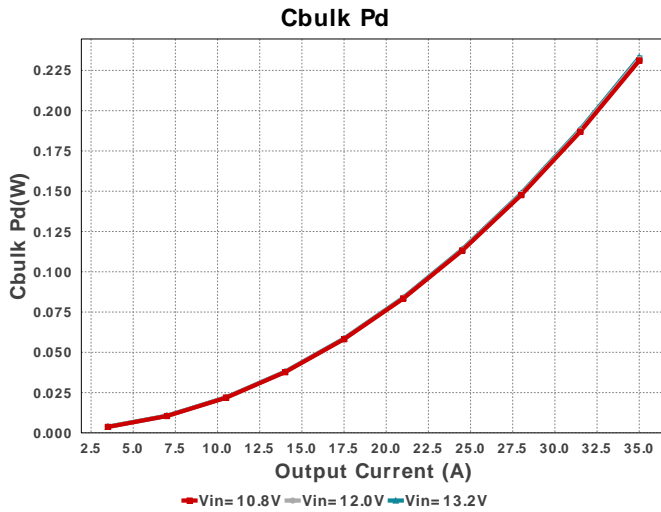

Operating Values

#	Name	Value	Category	Description
1.	BOM Count	35		Total Design BOM count
2.	Total BOM	NA		Total BOM Cost
3.	Cbulk IRMS	3.053 A	Capacitor	Bulk capacitor RMS ripple current
4.	Cbulk Pd	233.04 mW	Capacitor	Bulk capacitor power dissipation
5.	Cin IRMS	13.294 A	Capacitor	Input capacitor RMS ripple current
6.	Cin Pd	58.914 mW	Capacitor	Input capacitor power dissipation
7.	Cout IRMS	1.87 A	Capacitor	Output capacitor RMS ripple current
8.	Cout Pd	3.496 mW	Capacitor	Output capacitor power dissipation
9.	Coutx IRMS	595.565 mA	Capacitor	Output capacitor_x RMS ripple current
10.	Coutx Pd	7.094 mW	Capacitor	Output capacitor_x power loss
11.	Fpi	1.421 MHz	Compensation	Current Loop Pole Frequency
12.	Fpv	424.413 kHz	Compensation	Voltage Loop Pole Frequency
13.	Fzi	85.27 kHz	Compensation	Current Loop Zero Frequency
14.	Fzv	10.61 kHz	Compensation	Voltage Loop Zero Frequency
15.	ILOOP Gain	13.002	Compensation	Recommended Current Loop Mid-band Gain
16.	VLOOP Gain	1.746	Compensation	Recommended Voltage Loop Mid-band Gain
17.	Zout (Fco)	48.041 mOhm	Compensation	Output Impedance at Crossover Frequency
18.	Zout (Fsw)	4.831 mOhm	Compensation	Output Impedance at Switching Frequency
19.	IC Ipk	39.27 A	IC	Peak switch current in IC
20.	IC Tj	142.003 degC	IC	IC junction temperature
21.	ICThetaJA Effective	8.0 degC/W	IC	Effective IC Junction-to-Ambient Thermal Resistance
22.	Iin Avg	11.486 A	IC	Average input current
23.	U1 Pd	10.875 W	IC	IC power dissipation
24.	Ipp percentage	24.402 %	Inductor	Inductor ripple current percentage (with respect to average inductor current)
25.	L Ipp	8.541 A	Inductor	Peak-to-peak inductor ripple current
26.	L1 Pd	246.22 mW	Inductor	Inductor power dissipation
27.	CPI	3.2 pF	PMBus	Selectable compensation parameter through pinstrapping
28.	CPV	18.75 pF	PMBus	Selectable compensation parameter through pinstrapping
29.	CZI	53.328 pF	PMBus	Selectable compensation parameter through pinstrapping
30.	CZV	750.0 pF	PMBus	Selectable compensation parameter through pinstrapping
31.	GMI	200.0 μS	PMBus	Selectable compensation parameter through pinstrapping

#	Name	Value	Category	Description
32.	GMV	50.0 μ S	PMBus	Selectable compensation parameter through pinstrapping
33.	PMBus Vout Command	4.02	PMBus	PMBus Vout Command
34.	PMBus Vout Scale Loop	125.0 m	PMBus	PMBus Vout Scale Loop
35.	RV1	35.0 kOhm	PMBus	Selectable compensation parameter through pinstrapping
36.	RVV	20.0 kOhm	PMBus	Selectable compensation parameter through pinstrapping
37.	Cbulk Pd	233.04 mW	Power	Bulk capacitor power dissipation
38.	Cin Pd	58.914 mW	Power	Input capacitor power dissipation
39.	Cout Pd	3.496 mW	Power	Output capacitor power dissipation
40.	Coutx Pd	7.094 mW	Power	Output capacitor_x power loss
41.	L1 Pd	246.22 mW	Power	Inductor power dissipation
42.	Snubber Pd	191.664 mW	Power	Snubber Power Dissipation
43.	Total Pd	11.615 W	Power	Total Power Dissipation
44.	U1 Pd	10.875 W	Power	IC power dissipation
45.	Duty Cycle	31.72 %	System	Duty cycle
46.	Efficiency	92.339 %	System Information	Steady state efficiency
47.	FootPrint	1.349 k mm ²	System Information	Total Foot Print Area of BOM components
48.	Frequency	1.1 MHz	System Information	Switching frequency
49.	Gain Marg	-62.479 dB	System Information	Bode Plot Gain Margin
50.	Iout	35.0 A	System Information	Iout operating point
51.	Mode	CCM	System Information	Conduction Mode
52.	Pout	140.0 W	System Information	Total output power
53.	Vin	13.2 V	System Information	Vin operating point
54.	Vin p-p	232.772 mV	System Information	Peak-to-peak input voltage
55.	Vout	4.0 V	System Information	Operational Output Voltage
56.	Vout Tolerance	200.0 m%	System Information	Vout Tolerance based on IC Tolerance (no load) and voltage divider resistors if applicable
57.	Vout p-p	41.262 mV	System Information	Peak-to-peak output ripple voltage

Design Inputs

Name	Value	Description
Iout	35.0	Maximum Output Current
VinMax	13.2	Maximum input voltage
VinMin	10.8	Minimum input voltage
Vout	4.0	Output Voltage
base_pn	TPS546D24	Base Product Number
source	DC	Input Source Type
Ta	55.0	Ambient temperature
1. Vout Sch	4.0	Output voltage selected

WEBENCH® Assembly

Component Testing

Some published data on components in datasheets such as Capacitor ESR and Inductor DC resistance is based on conservative values that will guarantee that the components always exceed the specification. For design purposes it is usually better to work with typical values. Since this data is not always available it is a good practice to measure the Capacitance and ESR values of C_{in} and C_{out} , and the inductance and DC resistance of L1 before assembly of the board. Any large discrepancies in values should be electrically simulated in WEBENCH to check for instabilities and thermally simulated in WebTHERM to make sure critical temperatures are not exceeded.

Soldering Component to Board

If board assembly is done in house it is best to tack down one terminal of a component on the board then solder the other terminal. For surface mount parts with large tabs, such as the DPAK, the tab on the back of the package should be pre-tinned with solder, then tacked into place by one of the pins. To solder the tab down to the board place the iron down on the board while resting against the tab, heating both surfaces simultaneously. Apply light pressure to the top of the plastic case until the solder flows around the part and the part is flush with the PCB. If the solder is not flowing around the board you may need a higher wattage iron (generally 25W to 30W is enough).

Initial Startup of Circuit

It is best to initially power up the board by setting the input supply voltage to the lowest operating input voltage 10.8V and set the input supply's current limit to zero. With the input supply off connect up the input supply to V_{in} and GND. Connect a digital volt meter and a load if needed to set the minimum load of the design from V_{out} and GND. Turn on the input supply and slowly turn up the current limit on the input supply. If the voltage starts to rise on the input supply continue increasing the input supply current limit while watching the output voltage. If the current increases on the input supply, but the voltage remains near zero, then there may be a short or a component misplaced on the board. Power down the board and visually inspect for solder bridges and recheck the diode and capacitor polarities. Once the power supply circuit is operational then more extensive testing may include full load testing, transient load and line tests to compare with simulation results.

Load Testing

The setup is the same as the initial startup, except that an additional digital voltmeter is connected between V_{in} and GND, a load is connected between V_{out} and GND and a current meter is connected in series between V_{out} and the load. The load must be able to handle at least rated output power + 50% (7.5 watts for this design). Ideally the load is supplied in the form of a variable load test unit. It can also be done in the form of suitably large power resistors. When using an oscilloscope to measure waveforms on the prototype board, the ground leads of the oscilloscope probes should be as short as possible and the area of the loop formed by the ground lead should be kept to a minimum. This will help reduce ground lead inductance and eliminate EMI noise that is not actually present in the circuit.



WEBENCH® Electrical Simulation Report

Design Id = 16

sim_id = 2

Simulation Type = Load Transient

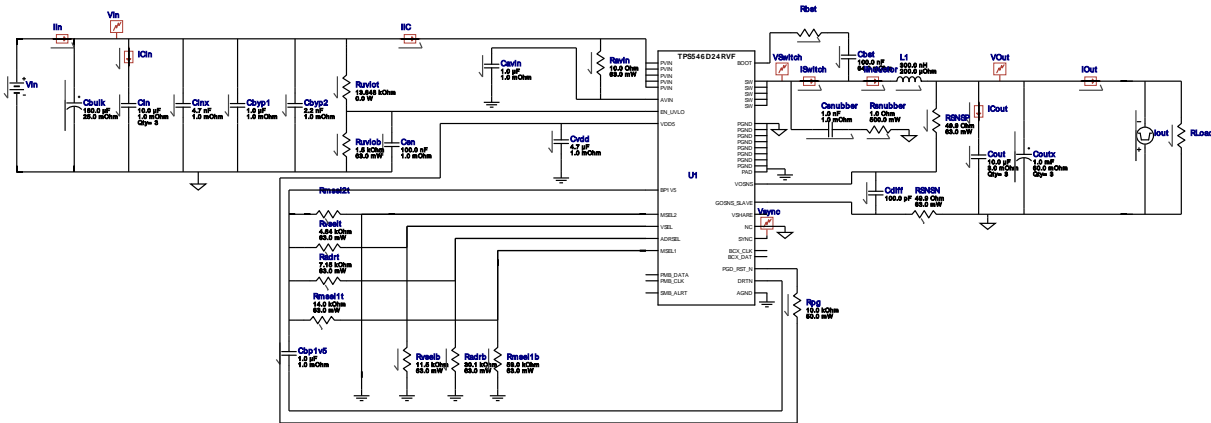

Simulation Parameters

#	Name	Parameter Name	Description	Values
1.	Cbp1v5	IC	no description	1.5 V
2.	Cen	IC	Initial Condition	2 V
3.	Cout	IC	Initial Voltage	4.0
4.	Rvselb	R	no description	Rvselb Ohm
5.	Radrb	R	no description	Radrb Ohm
6.	Rmsel1t	R	no description	Rmsel1t Ohm
7.	Rvselt	R	no description	Rvselt Ohm
8.	Cin	IC	Initial Voltage	12.0 V
9.	Rmsel2t	R	no description	1.0E9 Ohm
10.	RSNSP	R	no description	1e-6 ohm
11.	Coutx	IC	Initial Condition	4.0 V
12.	L1	IC	Initial Voltage	35.0 A
13.	RSNSN	R	no description	1e-6 ohm
14.	Cbst	IC	Initial voltage	12.0
15.	Rmsel1b	R	no description	Rmsel1b Ohm
16.	Cvdd	IC	Initial voltage	5 V
17.	Radrt	R	no description	Radrt Ohm
18.	Iout	signal_type I1	signal type Initial Load Current	PULSE 0 A

#	Name	Parameter Name	Description	Values
		I2	Minimum Load Current	31.5 A
		Td	Initial Time Delay	100u s
		Tf	Fall Time	25u s
		Tr	Rise Time	25u s
		Pw	Pulse Width	500u s
19.	RLoad	R	Load Resistance	0.11428571428571428 Ohm

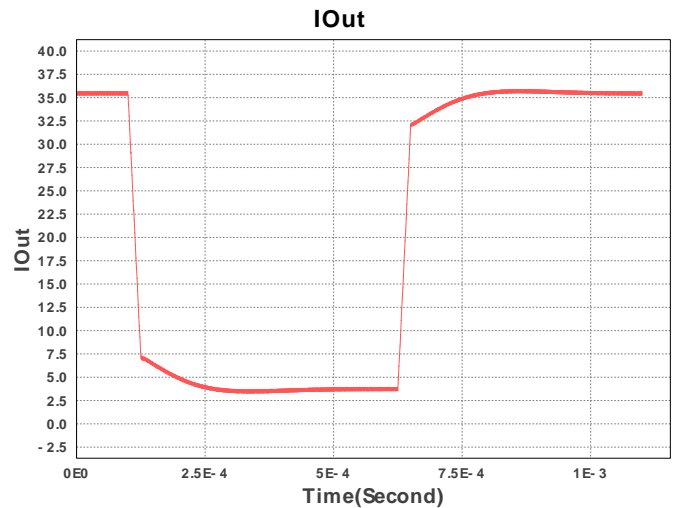
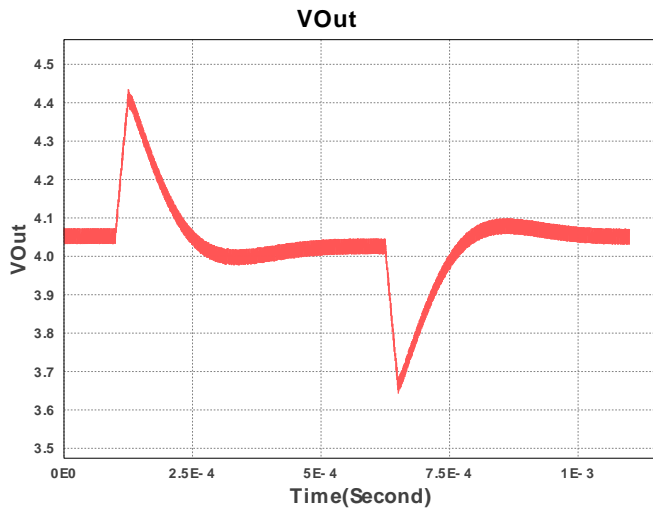

Design Assistance

1. Master key : FFCBE594482CC2C8[v1]
2. **TPS546D24** Product Folder : <http://www.ti.com/product/TPS546D24> : contains the data sheet and other resources.

Important Notice and Disclaimer

TI provides technical and reliability data (including datasheets), design resources (including reference designs), application or other design advice, web tools, safety information, and other resources AS IS and with all faults, and disclaims all warranties. These resources are intended for skilled developers designing with TI products. You are solely responsible for (1) selecting the appropriate TI products for your application, (2) designing, validating and testing your application, and (3) ensuring your application meets applicable standards, and any other safety, security, or other requirements.

These resources are subject to change without notice. TI grants you permission to use these resources only for development of an application that uses the TI products described in the resource. Other reproduction and display of these resources is prohibited. No license is granted to any other TI intellectual property right or to any third party intellectual property right. TI disclaims responsibility for, and you will fully indemnify TI and its representatives against, any claims, damages, costs, losses, and liabilities arising out of your use of these resources.

Providing these resources does not expand or otherwise alter TI's applicable Terms of Sale or other applicable terms available either on ti.com or provided in conjunction with TI products.