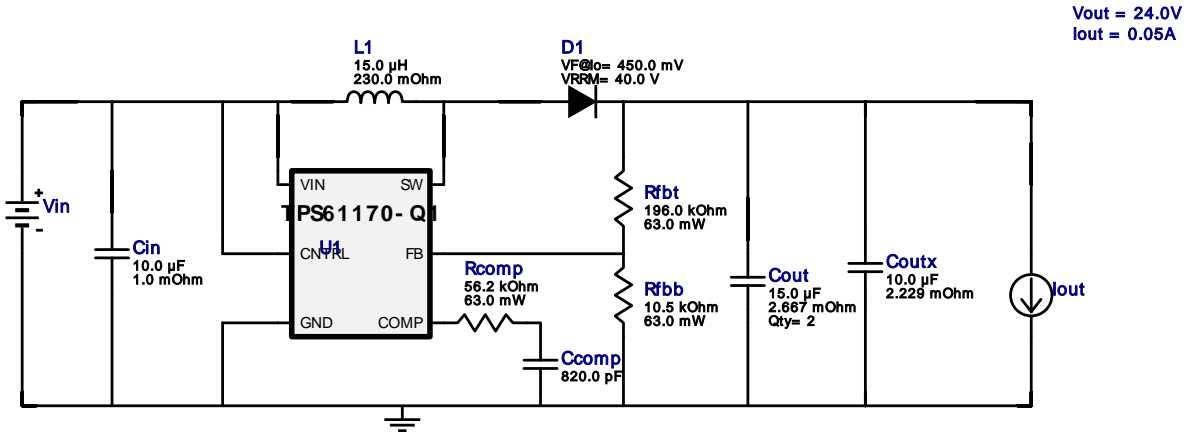

WEBENCH® Design Report

 Design : 22 TPS61170QDRVRQ1
 TPS61170QDRVRQ1 3V-3.7V to 24V @ 50mA Coutx3

Vout = 24.0V
Iout = 0.05A

1. This regulator device is qualified for Automotive applications. All passives and other components selected in this design may not be qualified for Automotive applications. The user is required to verify that all components in the design meet the qualification and safety requirements for their specific application. View WEBENCH(R) Disclaimer.

Design Alerts
Component Selection Information

The TPS61170-Q1 is qualified for Automotive applications. All passives and other components selected in this design may not be qualified for Automotive applications. The user is required to verify that all components in the design meet the qualification and safety requirements for their specific application. View WEBENCH(R) Disclaimer

Electrical BOM

Name	Manufacturer	Part Number	Properties	Qty	Price	Footprint
Ccomp	Samsung Electro-Mechanics	CL10C821JB8NFNC Series= C0G/NP0	Cap= 820.0 pF VDC= 50.0 V IRMS= 0.0 A	1	\$0.20	0603 5 mm ²
Cin	MuRata	GRM32ER71H106KA12L Series= X7R	Cap= 10.0 uF ESR= 1.0 mOhm VDC= 50.0 V IRMS= 6.0 A	1	\$0.43	1210_270 15 mm ²
Cout	TDK	C3216X5R1V156M160AC Series= X5R	Cap= 15.0 uF ESR= 2.667 mOhm VDC= 35.0 V IRMS= 4.4429 A	2	\$0.37	1206_180 11 mm ²
Coutx	TDK	CGA5L1X7R1V106K160AC Series= X7R	Cap= 10.0 uF ESR= 2.229 mOhm VDC= 35.0 V IRMS= 4.8593 A	1	\$0.24	1206_190 11 mm ²
D1	Diodes Inc.	1N5819HW-7-F	VF@Io= 450.0 mV VRRM= 40.0 V	1	\$0.08	SOD-123 13 mm ²
L1	Würth Elektronik	74438356150	L= 15.0 uH 230.0 mOhm	1	\$1.23	WE-MAPI_4020 26 mm ²
Rcomp	Vishay-Dale	CRCW040256K2FKED Series= CRCW..e3	Res= 56.2 kOhm Power= 63.0 mW Tolerance= 1.0%	1	\$0.01	0402 3 mm ²
Rfbb	Vishay-Dale	CRCW040210K5FKED Series= CRCW..e3	Res= 10.5 kOhm Power= 63.0 mW Tolerance= 1.0%	1	\$0.01	0402 3 mm ²

Name	Manufacturer	Part Number	Properties	Qty	Price	Footprint
Rfbt	Vishay-Dale	CRCW0402196KFKED Series= CRCW..e3	Res= 196.0 kOhm Power= 63.0 mW Tolerance= 1.0%	1	\$0.01	0402 3 mm ²
U1	Texas Instruments	TPS61170QDRVRQ1	Switcher	1	\$0.83	S-PWSON-N6 9 mm ²

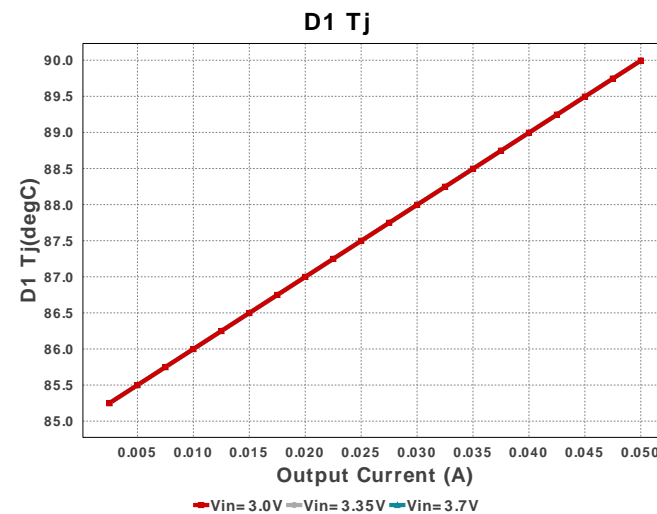
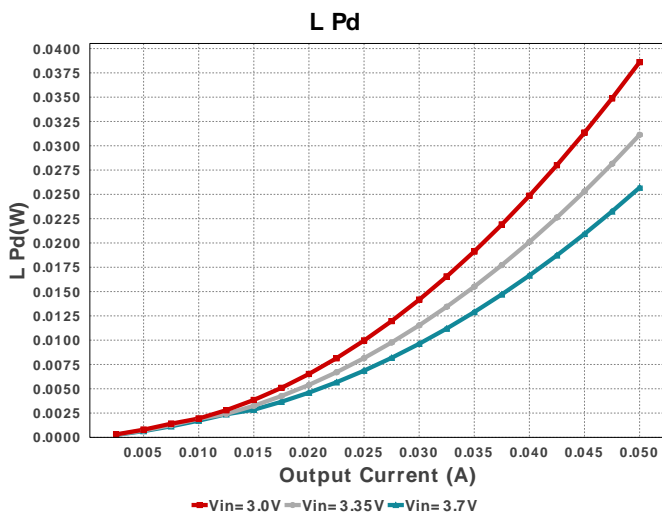
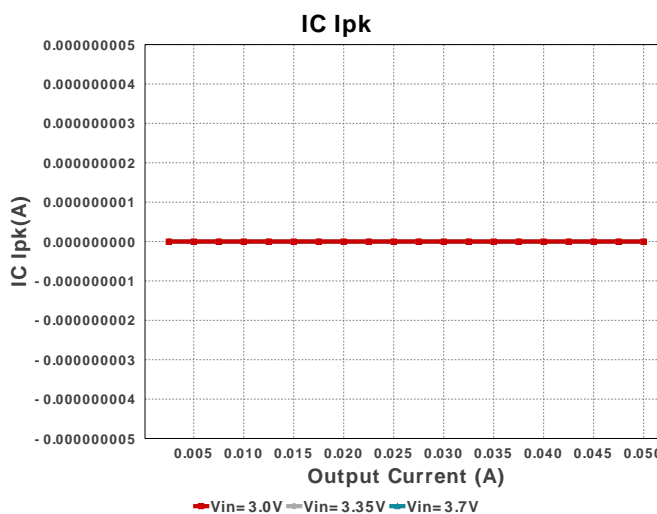
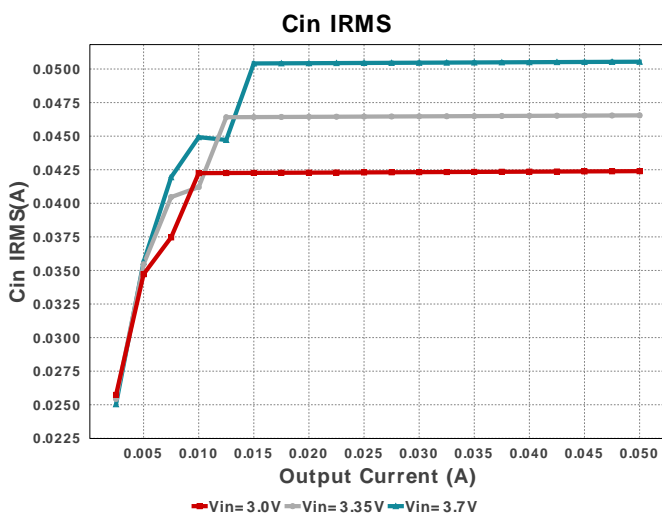
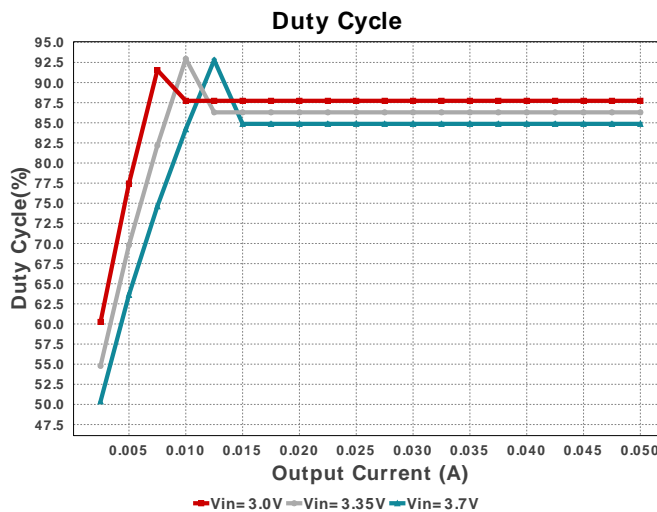
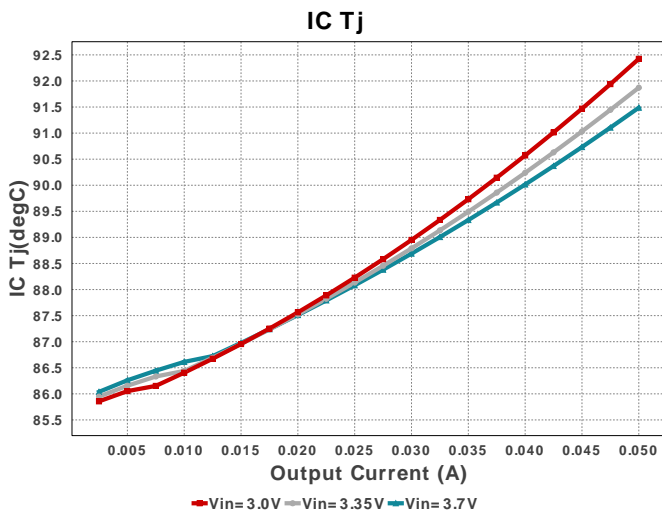

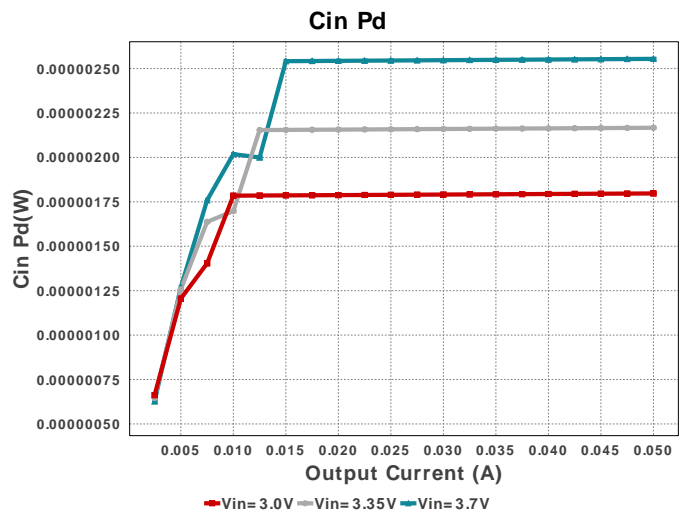
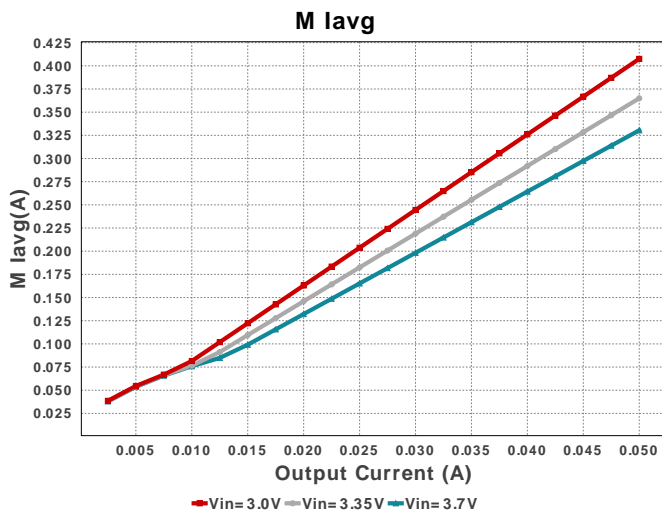
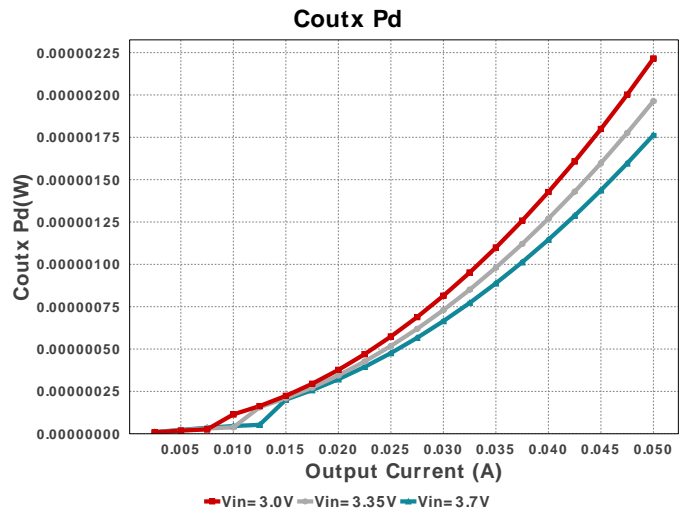
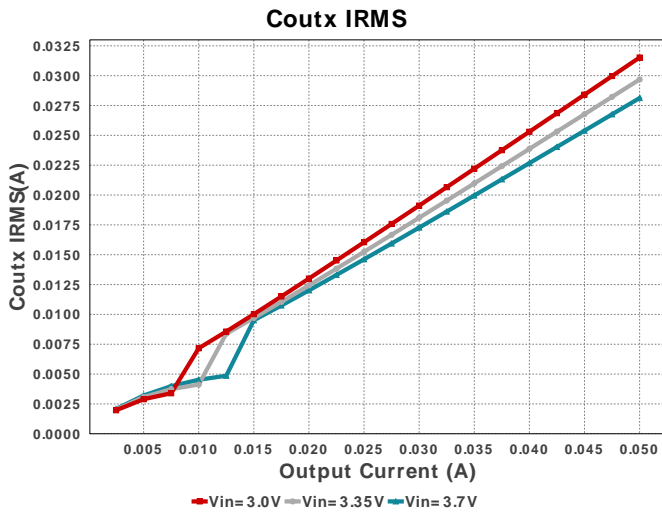
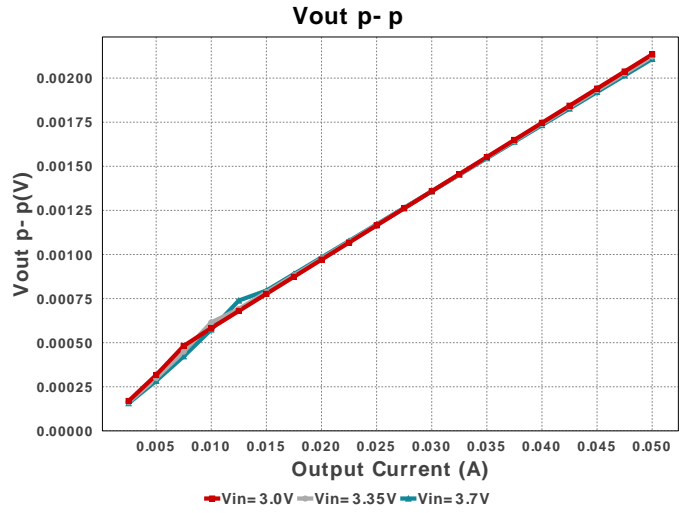
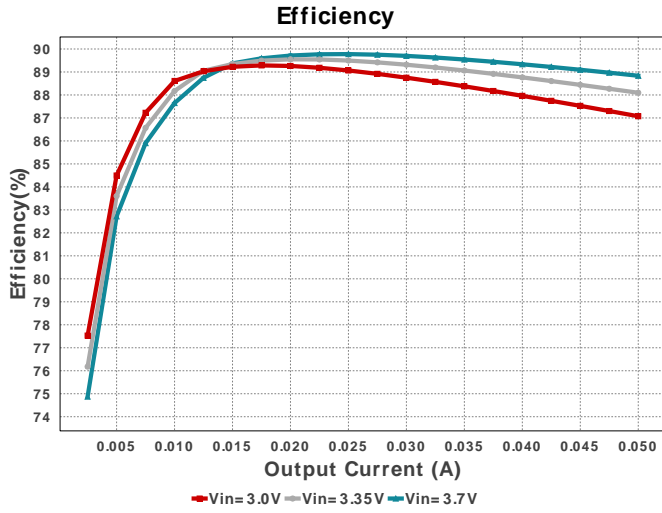

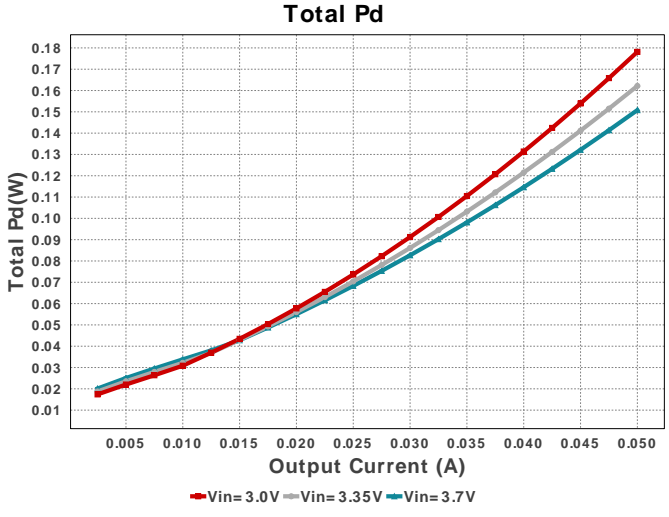
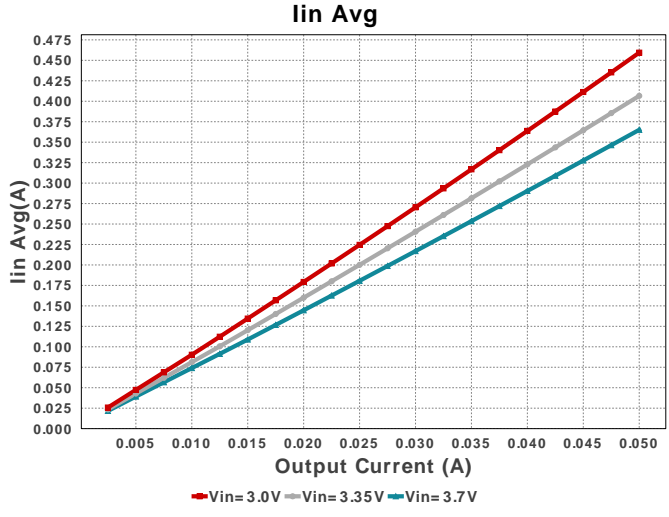
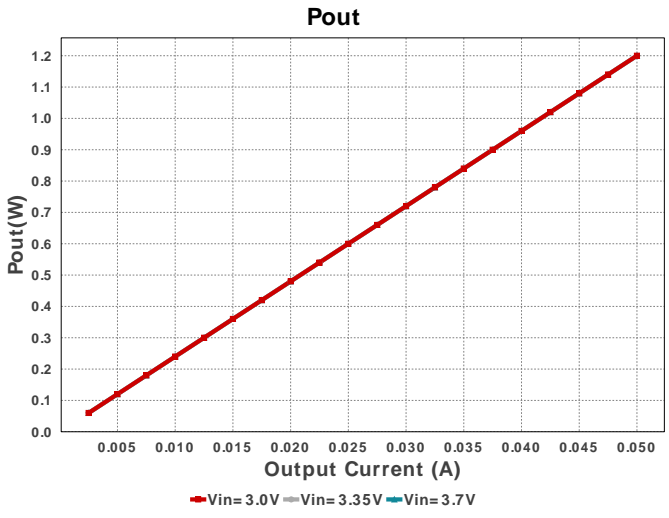
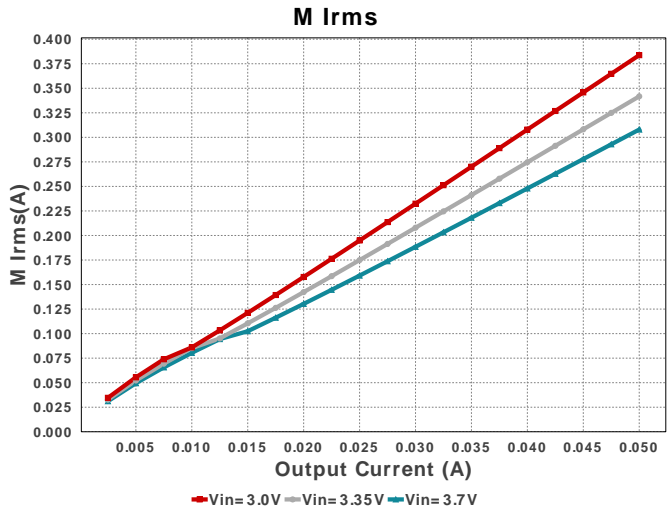
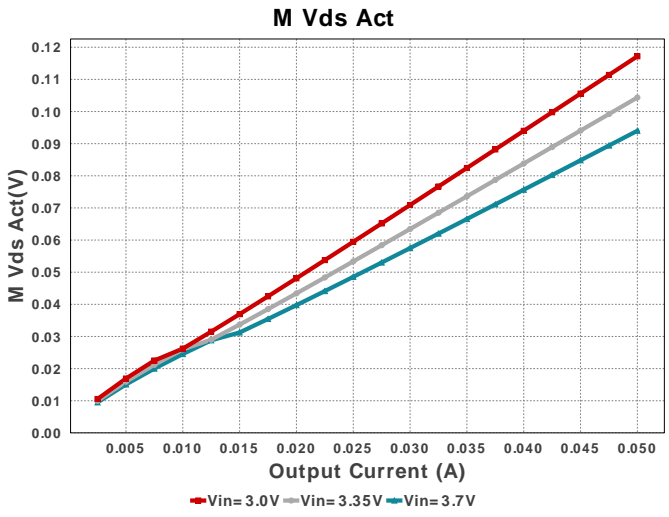
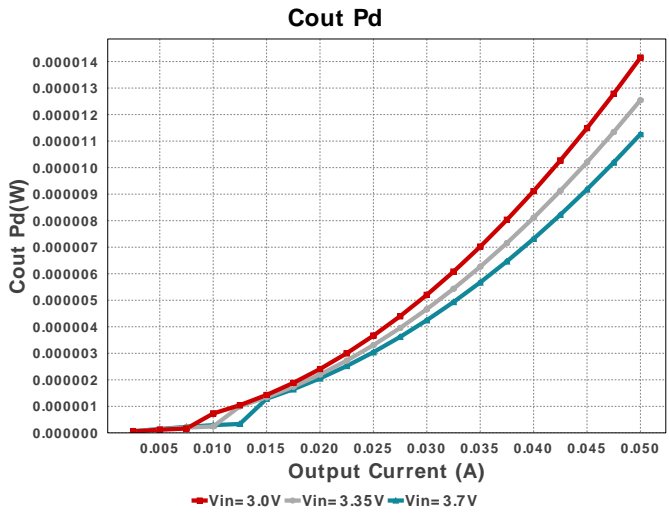

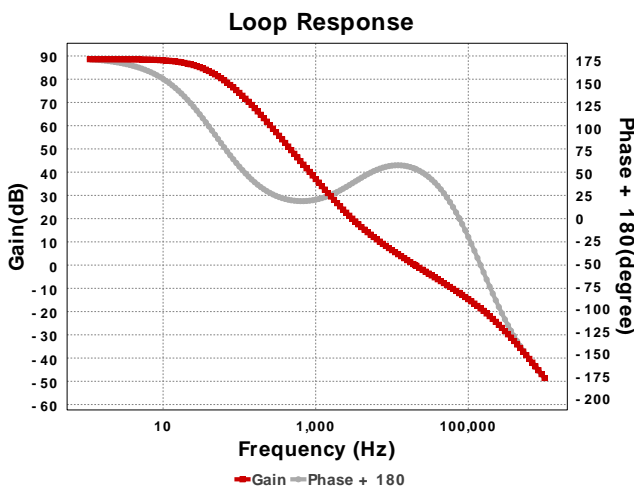
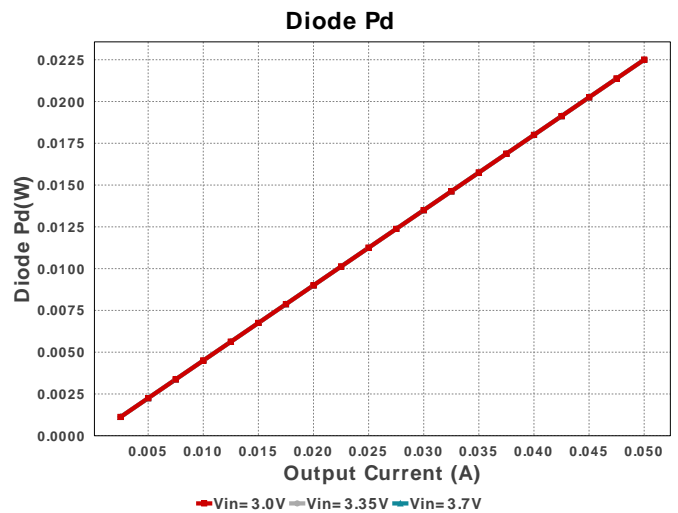
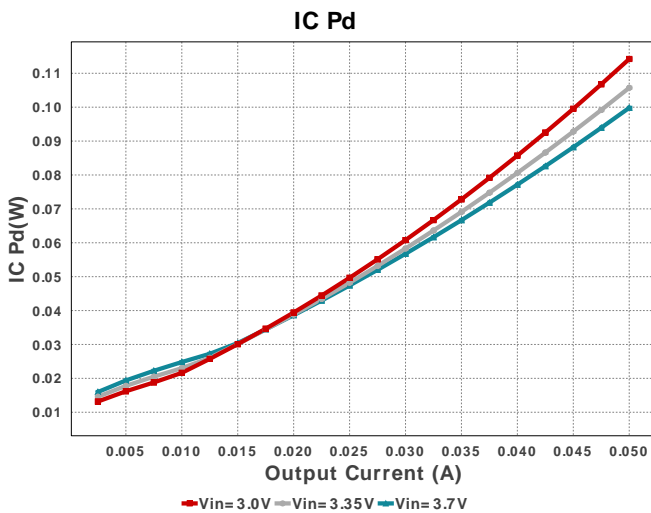
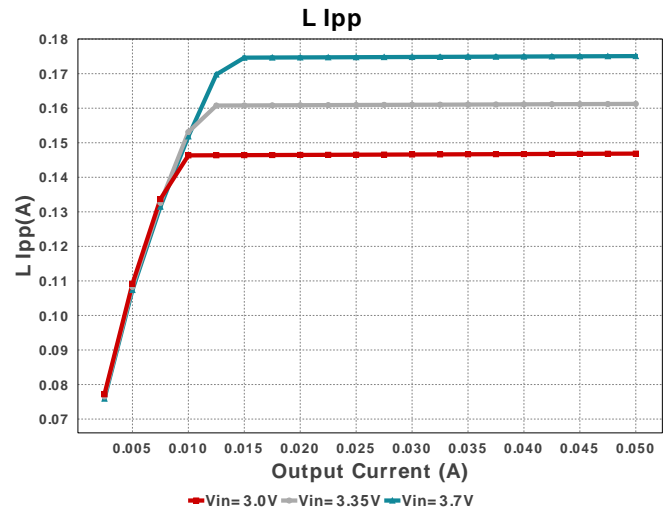
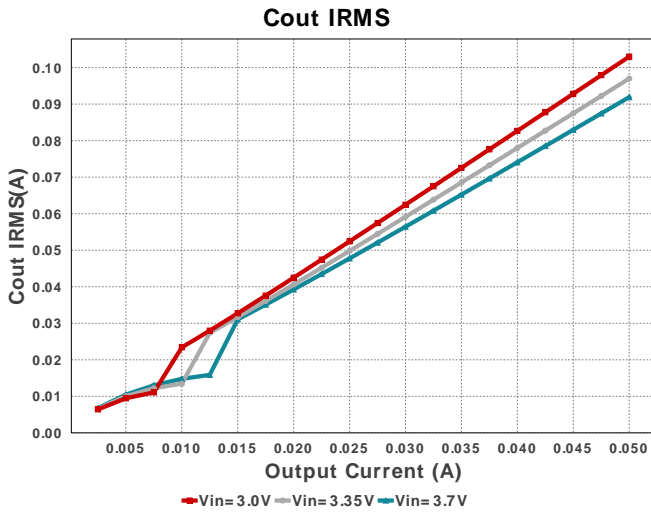

Operating Values

#	Name	Value	Category	Description
1.	BOM Count	11		Total Design BOM count
2.	Total BOM	\$3.78		Total BOM Cost
3.	Cin IRMS	42.394 mA	Capacitor	Input capacitor RMS ripple current
4.	Cin Pd	1.797 μ W	Capacitor	Input capacitor power dissipation
5.	Cout IRMS	102.997 mA	Capacitor	Output capacitor RMS ripple current
6.	Cout Pd	14.146 μ W	Capacitor	Output capacitor power dissipation
7.	Coutx IRMS	31.522 mA	Capacitor	Output capacitor_x RMS ripple current
8.	Coutx Pd	2.215 μ W	Capacitor	Output capacitor_x power loss
9.	D1 Tj	89.995 degC	Diode	D1 junction temperature
10.	Diode Pd	22.5 mW	Diode	Diode power dissipation
11.	IC Ipk	0.0 A	IC	Peak switch current in IC

#	Name	Value	Category	Description
12.	IC Pd	114.22 mW	IC	IC power dissipation
13.	IC Tj	92.424 degC	IC	IC junction temperature
14.	IC Tolerance	20.0 mV	IC	IC Feedback Tolerance
15.	ICThetaJA	65.0 degC/W	IC	IC junction-to-ambient thermal resistance
16.	Iin Avg	459.38 mA	IC	Average input current
17.	L Ipp	146.856 mA	Inductor	Peak-to-peak inductor ripple current
18.	L Pd	38.606 mW	Inductor	Inductor power dissipation
19.	M Iavg	407.5 mA	Mosfet	MOSFET Average current
20.	M Irms	383.742 mA	Mosfet	MOSFET RMS ripple current
21.	M Vds Act	117.192 mV	Mosfet	Voltage drop across the MosFET
22.	Cin Pd	1.797 µW	Power	Input capacitor power dissipation
23.	Cout Pd	14.146 µW	Power	Output capacitor power dissipation
24.	Coutx Pd	2.215 µW	Power	Output capacitor_x power loss
25.	Diode Pd	22.5 mW	Power	Diode power dissipation
26.	IC Pd	114.22 mW	Power	IC power dissipation
27.	L Pd	38.606 mW	Power	Inductor power dissipation
28.	Total Pd	178.138 mW	Power	Total Power Dissipation
29.	Cross Freq	16.583 kHz	System	Bode plot crossover frequency
30.	Duty Cycle	87.73 %	System Information	Duty cycle
31.	Efficiency	87.074 %	System Information	Steady state efficiency
32.	FootPrint	109.0 mm ²	System Information	Total Foot Print Area of BOM components
33.	Frequency	1.2 MHz	System Information	Switching frequency
34.	Gain Marg	-10.925 dB	System Information	Bode Plot Gain Margin
35.	Iout	50.0 mA	System Information	Iout operating point
36.	Low Freq Gain	87.406 dB	System Information	Gain at 1Hz
37.	Mode	CCM	System Information	Conduction Mode
38.	Phase Marg	52.223 deg	System Information	Bode Plot Phase Margin
39.	Pout	1.2 W	System Information	Total output power
40.	Vin	3.0 V	System Information	Vin operating point
41.	Vout	24.0 V	System Information	Operational Output Voltage
42.	Vout Actual	24.17 V	System Information	Vout Actual calculated based on selected voltage divider resistors
43.	Vout Tolerance	3.576 %	System Information	Vout Tolerance based on IC Tolerance (no load) and voltage divider resistors if applicable
44.	Vout p-p	2.134 mV	System Information	Peak-to-peak output ripple voltage

Design Inputs

Name	Value	Description
Iout	50.0 m	Maximum Output Current
VinMax	3.7	Maximum input voltage
VinMin	3.0	Minimum input voltage
Vout	24.0	Output Voltage
base_pn	TPS61170-Q1	Base Product Number
source	DC	Input Source Type
Ta	85.0	Ambient temperature

WEBENCH® Assembly

Component Testing

Some published data on components in datasheets such as Capacitor ESR and Inductor DC resistance is based on conservative values that will guarantee that the components always exceed the specification. For design purposes it is usually better to work with typical values. Since this data is not always available it is a good practice to measure the Capacitance and ESR values of C_{in} and C_{out} , and the inductance and DC resistance of L1 before assembly of the board. Any large discrepancies in values should be electrically simulated in WEBENCH to check for instabilities and thermally simulated in WebTHERM to make sure critical temperatures are not exceeded.

Soldering Component to Board

If board assembly is done in house it is best to tack down one terminal of a component on the board then solder the other terminal. For surface mount parts with large tabs, such as the DPAK, the tab on the back of the package should be pre-tinned with solder, then tacked into place by one of the pins. To solder the tab down to the board place the iron down on the board while resting against the tab, heating both surfaces simultaneously. Apply light pressure to the top of the plastic case until the solder flows around the part and the part is flush with the PCB. If the solder is not flowing around the board you may need a higher wattage iron (generally 25W to 30W is enough).

Initial Startup of Circuit

It is best to initially power up the board by setting the input supply voltage to the lowest operating input voltage 3.0V and set the input supply's current limit to zero. With the input supply off connect up the input supply to V_{in} and GND. Connect a digital volt meter and a load if needed to set the minimum load of the design from V_{out} and GND. Turn on the input supply and slowly turn up the current limit on the input supply. If the voltage starts to rise on the input supply continue increasing the input supply current limit while watching the output voltage. If the current increases on the input supply, but the voltage remains near zero, then there may be a short or a component misplaced on the board. Power down the board and visually inspect for solder bridges and recheck the diode and capacitor polarities. Once the power supply circuit is operational then more extensive testing may include full load testing, transient load and line tests to compare with simulation results.

Load Testing

The setup is the same as the initial startup, except that an additional digital voltmeter is connected between V_{in} and GND, a load is connected between V_{out} and GND and a current meter is connected in series between V_{out} and the load. The load must be able to handle at least rated output power + 50% (7.5 watts for this design). Ideally the load is supplied in the form of a variable load test unit. It can also be done in the form of suitably large power resistors. When using an oscilloscope to measure waveforms on the prototype board, the ground leads of the oscilloscope probes should be as short as possible and the area of the loop formed by the ground lead should be kept to a minimum. This will help reduce ground lead inductance and eliminate EMI noise that is not actually present in the circuit.



Design Assistance

1. The TPS61170-Q1 is qualified for Automotive applications. All passives and other components selected in this design may not be qualified for Automotive applications. The user is required to verify that all components in the design meet the qualification and safety requirements for their specific application
2. Master key : BB4FF38B303A806B[v1]
3. **TPS61170-Q1** Product Folder : <http://www.ti.com/product/TPS61170%2DQ1> : contains the data sheet and other resources.

WEBENCH® Electrical Simulation Report

Design Id = 22

sim_id = 7

Simulation Type = Input Transient

VinMax = 3.7V

Iout = 0.05A

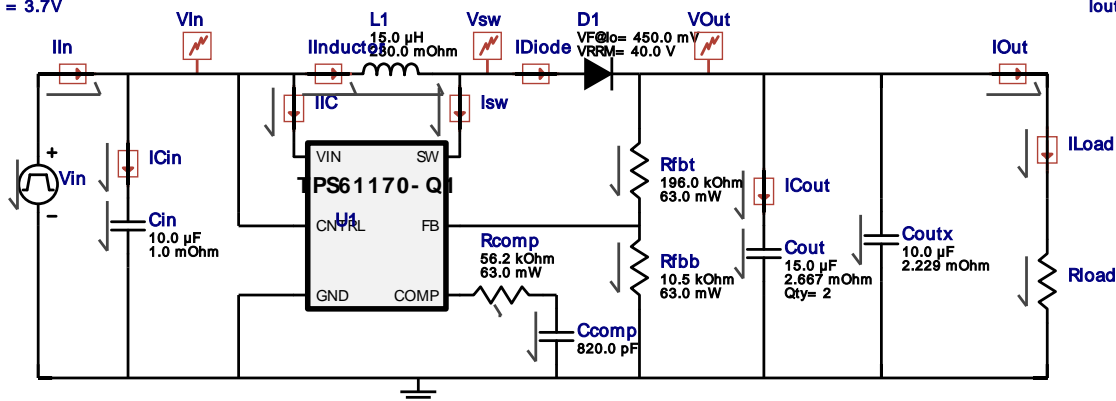

Simulation Parameters

#	Name	Parameter Name	Description	Values
1.	Rload	R	Load Resistance	480.0 Ohm

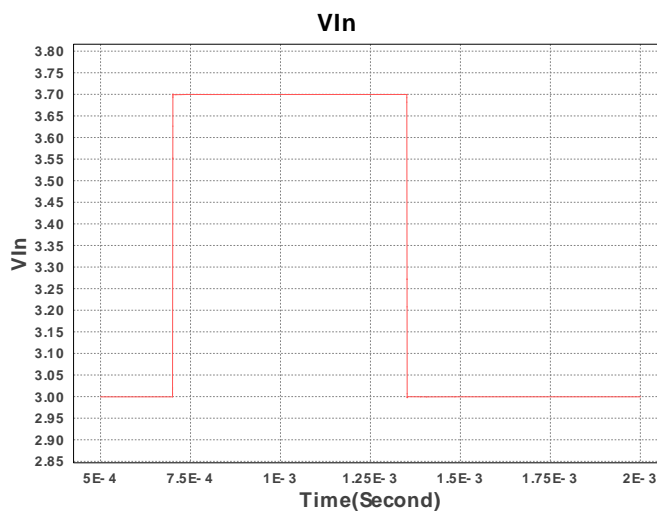
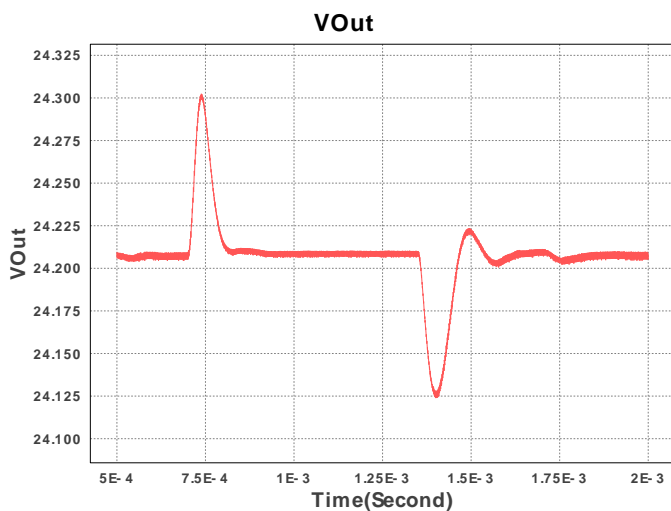

Design Assistance

1. The TPS61170-Q1 is qualified for Automotive applications. All passives and other components selected in this design may not be qualified for Automotive applications. The user is required to verify that all components in the design meet the qualification and safety requirements for their specific application

2. Master key : BB4FF38B303A806B[v1]

3. **TPS61170-Q1** Product Folder : <http://www.ti.com/product/TPS61170%2DQ1> : contains the data sheet and other resources.

WEBENCH® Electrical Simulation Report

Design Id = 22

sim_id = 6

Simulation Type = Load Transient

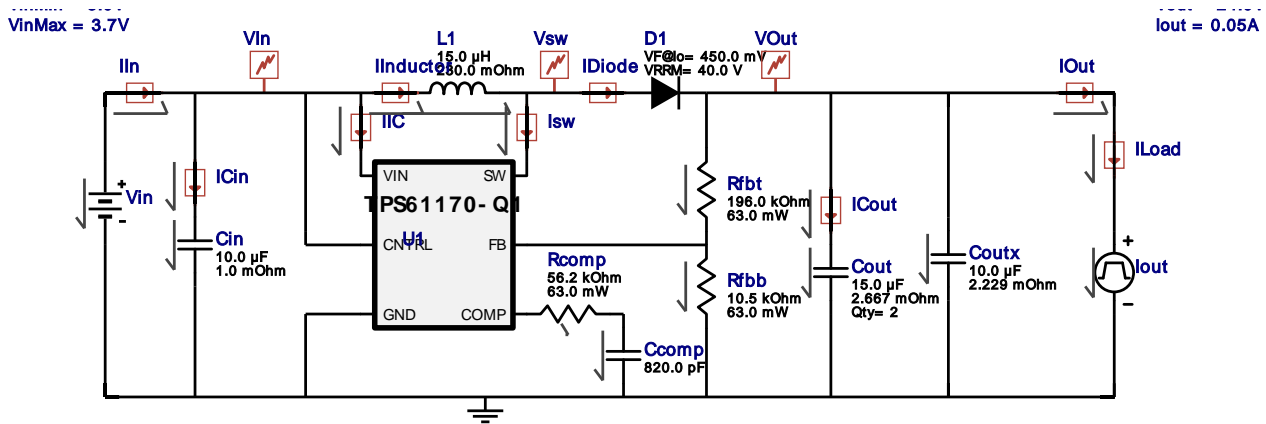

Simulation Parameters

#	Name	Parameter Name	Description	Values
1.	Iout	signal_type	Signal Type	PULSE
		I1	Initial Load Current	0.05 A
		I2	Minimum Load Current	0.005 A
		Td	Initial Time Delay	500u s
		Tf	Fall Time	1u s
		Tr	Rise Time	1u s
		Pw	Pulse Width	1.3m s

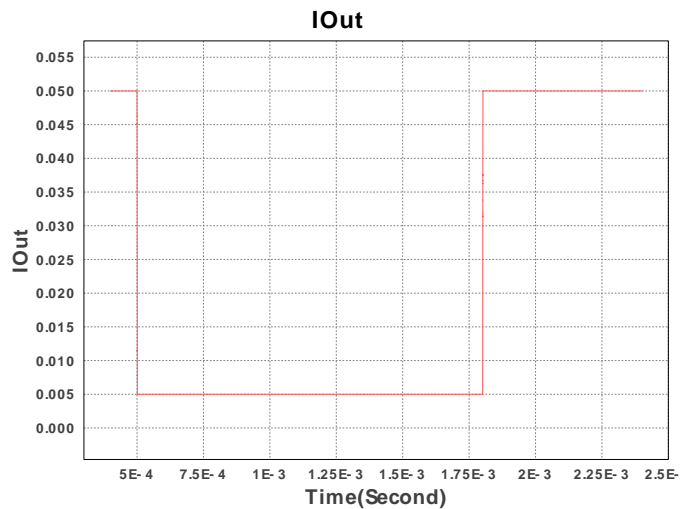
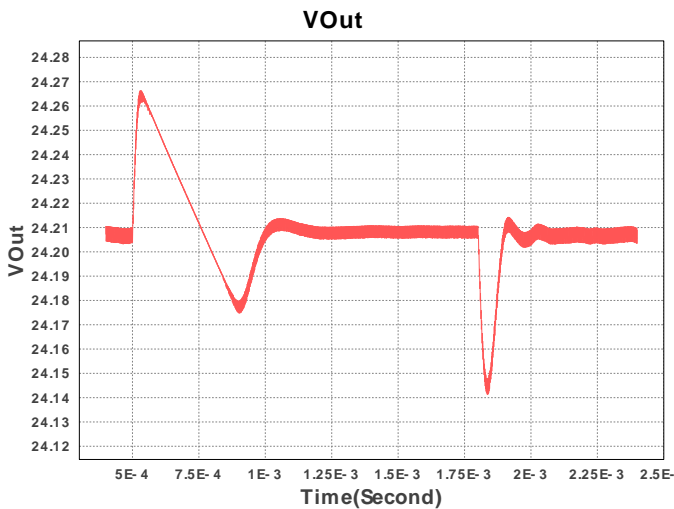

Design Assistance

- The TPS61170-Q1 is qualified for Automotive applications. All passives and other components selected in this design may not be qualified for Automotive applications. The user is required to verify that all components in the design meet the qualification and safety requirements for their specific application
- Master key : BB4FF38B303A806B[v1]
- TPS61170-Q1** Product Folder : <http://www.ti.com/product/TPS61170%2DQ1> : contains the data sheet and other resources.

WEBENCH® Electrical Simulation Report

Design Id = 22

sim_id = 5

Simulation Type = Startup

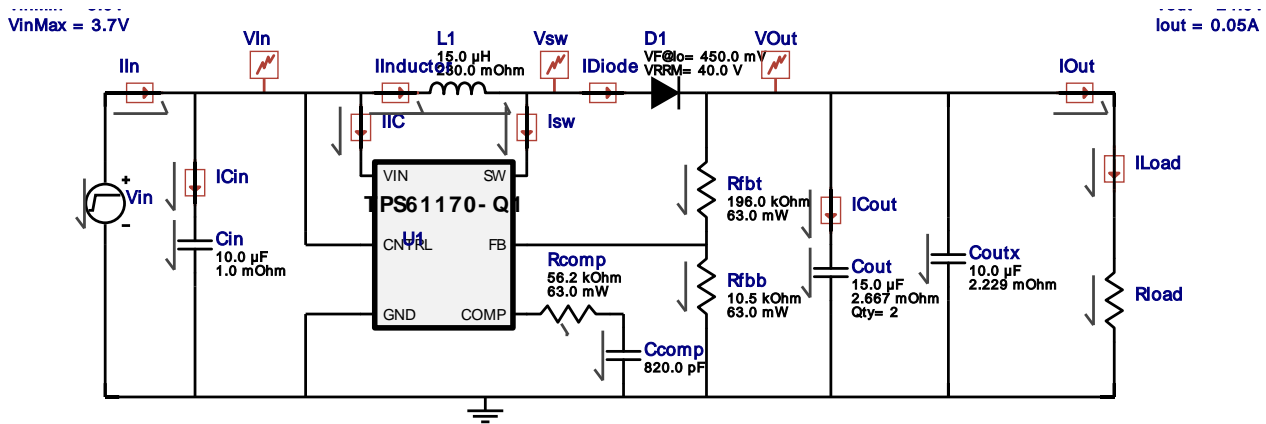

Simulation Parameters

#	Name	Parameter Name	Description	Values
1.	Rload	R	Load Resistance	480.0 Ohm

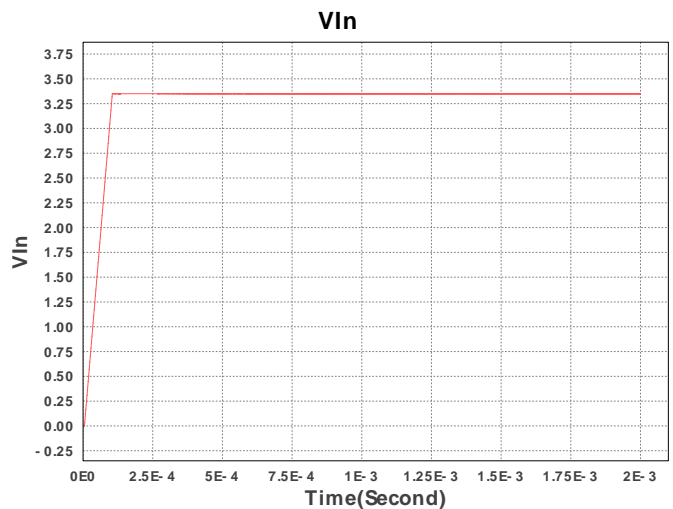
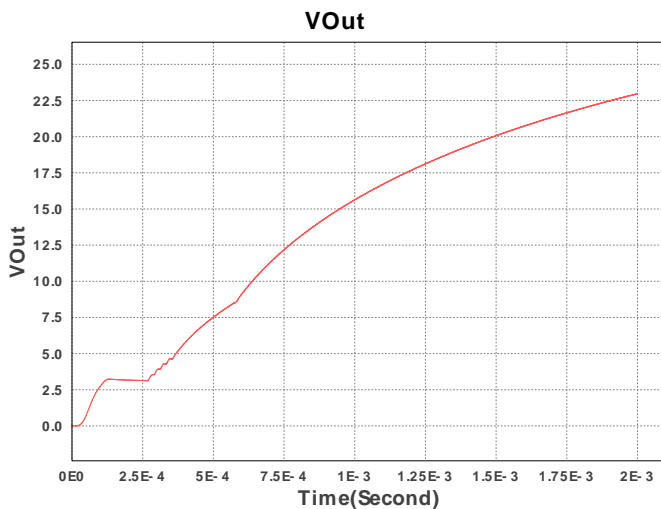

Design Assistance

1. The TPS61170-Q1 is qualified for Automotive applications. All passives and other components selected in this design may not be qualified for Automotive applications. The user is required to verify that all components in the design meet the qualification and safety requirements for their specific application

2. Master key : BB4FF38B303A806B[v1]

3. **TPS61170-Q1** Product Folder : <http://www.ti.com/product/TPS61170%2DQ1> : contains the data sheet and other resources.

WEBENCH® Electrical Simulation Report

Design Id = 22

sim_id = 8

Simulation Type = Steady State

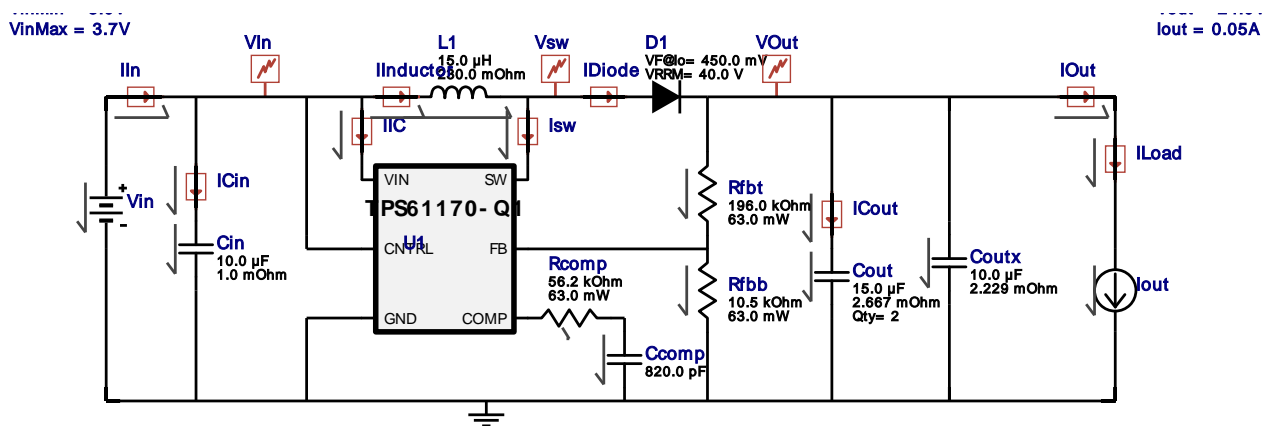

Simulation Parameters

#	Name	Parameter Name	Description	Values
1.	IInductorIC		Initial Condition	IOut A
2.	Iout	I	Load current	0.05

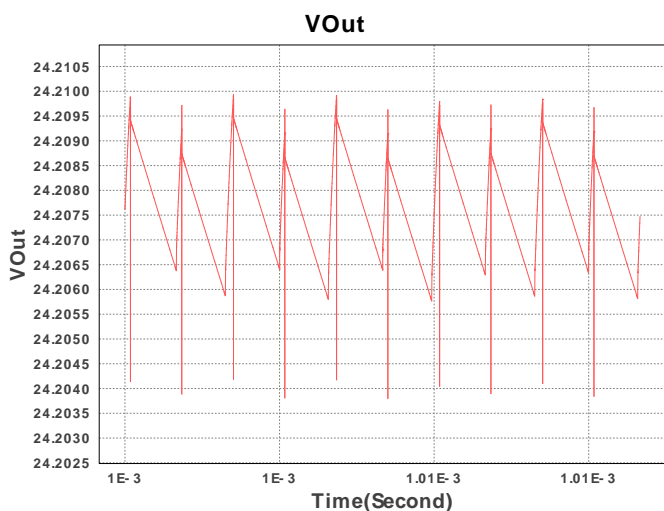

Design Assistance

- The TPS61170-Q1 is qualified for Automotive applications. All passives and other components selected in this design may not be qualified for Automotive applications. The user is required to verify that all components in the design meet the qualification and safety requirements for their specific application
- Master key : BB4FF38B303A806B[v1]
- TPS61170-Q1** Product Folder : <http://www.ti.com/product/TPS61170%2DQ1> : contains the data sheet and other resources.

Important Notice and Disclaimer

TI provides technical and reliability data (including datasheets), design resources (including reference designs), application or other design advice, web tools, safety information, and other resources AS IS and with all faults, and disclaims all warranties. These resources are intended for skilled developers designing with TI products. You are solely responsible for (1) selecting the appropriate TI products for your application, (2) designing, validating and testing your application, and (3) ensuring your application meets applicable standards, and any other safety, security, or other requirements.

These resources are subject to change without notice. TI grants you permission to use these resources only for development of an application that uses the TI products described in the resource. Other reproduction and display of these resources is prohibited. No license is granted to any other TI intellectual property right or to any third party intellectual property right. TI disclaims responsibility for, and you will fully indemnify TI and its representatives against, any claims, damages, costs, losses, and liabilities arising out of your use of these resources.

Providing these resources does not expand or otherwise alter TI's applicable Terms of Sale or other applicable terms available either on ti.com or provided in conjunction with TI products.