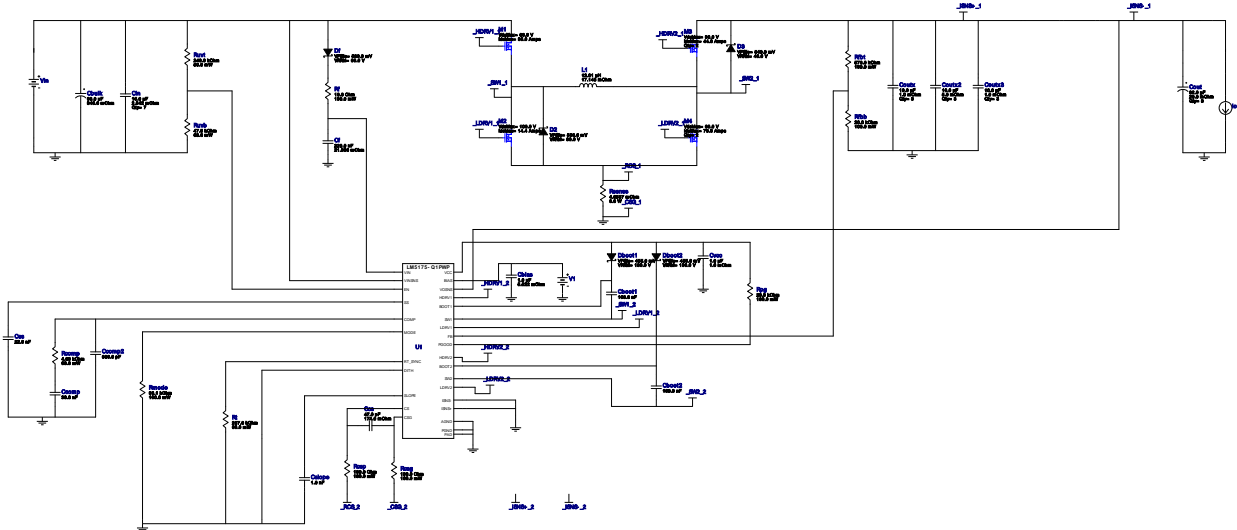

WEBENCH® Design Report

 Design : 22 LM5175QPWPRQ1
 LM5175QPWPRQ1 8V-38V to 24.00V @ 7A

1. This regulator device is qualified for Automotive applications. All passives and other components selected in this design may not be qualified for Automotive applications. The user is required to verify that all components in the design meet the qualification and safety requirements for their specific application. View WEBENCH(R) Disclaimer.

Design Alerts

Component Selection Information

The LM5175-Q1 is qualified for Automotive applications. All passives and other components selected in this design may not be qualified for Automotive applications. The user is required to verify that all components in the design meet the qualification and safety requirements for their specific application. Please note that since parallel FETs have been chosen in this design, schematic and PCB export features will not work

Electrical BOM

Name	Manufacturer	Part Number	Properties	Qty	Price	Footprint
Cbias	TDK	C1608X6S1H105K080AC Series= X6S	Cap= 1.0 uF ESR= 5.522 mOhm VDC= 50.0 V IRMS= 2.2162 A	1	\$0.05	0603 5 mm ²
Cboot1	AVX	08053C104JAZ2A Series= X7R	Cap= 100.0 nF VDC= 25.0 V IRMS= 0.0 A	1	\$0.06	0805 7 mm ²
Cboot2	AVX	08053C104JAZ2A Series= X7R	Cap= 100.0 nF VDC= 25.0 V IRMS= 0.0 A	1	\$0.06	0805 7 mm ²
Cbulk	Nichicon	UUD1H680MNL1GS Series= uD	Cap= 68.0 uF ESR= 340.0 mOhm VDC= 50.0 V IRMS= 300.0 mA	1	\$0.20	 SM_RADIAL_8MM 113 mm ²
Ccomp	TDK	CGA4J2C0G1H333J125AA Series= C0G/NP0	Cap= 33.0 nF VDC= 50.0 V IRMS= 0.0 A	1	\$0.09	0805 7 mm ²
Ccomp2	Samsung Electro-Mechanics	CL05C681JB5NNNC Series= C0G/NP0	Cap= 680.0 pF VDC= 50.0 V IRMS= 0.0 A	1	\$0.01	0402 3 mm ²
Ccs	AVX	06035A470JAT2A Series= C0G/NP0	Cap= 47.0 pF ESR= 174.0 mOhm VDC= 50.0 V IRMS= 0.0 A	1	\$0.01	0603 5 mm ²

Name	Manufacturer	Part Number	Properties	Qty	Price	Footprint
Cf	TDK	CGA3E3X7R1H224K080AB Series= X7R	Cap= 220.0 nF ESR= 21.699 mOhm VDC= 50.0 V IRMS= 1.125 A	1	\$0.03	 0603 5 mm ²
Cin	TDK	C5750X7S2A156M250KB Series= X7S	Cap= 15.0 uF ESR= 2.642 mOhm VDC= 100.0 V IRMS= 5.6162 A	7	\$1.23	 2220_280 54 mm ²
Cout	Panasonic	35SVPF82M Series= SVPF	Cap= 82.0 uF ESR= 20.0 mOhm VDC= 35.0 V IRMS= 4.0 A	3	\$0.63	 CAPSMT_62_E12 106 mm ²
Coutx	MuRata	GRM32ER71H106MA12 Series= X7R	Cap= 10.0 uF ESR= 1.0 mOhm VDC= 50.0 V IRMS= 0.0 A	3	\$0.33	 1210_270 15 mm ²
Coutx2	TDK	C5750X7S2A106M230KB Series= X7S	Cap= 10.0 uF ESR= 5.0 mOhm VDC= 100.0 V IRMS= 6.45 A	3	\$0.86	 2220 54 mm ²
Coutx3	MuRata	GRM32ER71H106MA12 Series= X7R	Cap= 10.0 uF ESR= 1.0 mOhm VDC= 50.0 V IRMS= 0.0 A	3	\$0.33	 1210_270 15 mm ²
Cslope	MuRata	GRM1885C1H102JA01J Series= C0G/NP0	Cap= 1.0 nF VDC= 50.0 V IRMS= 0.0 A	1	\$0.01	 0603 5 mm ²
Css	TDK	CGA4J2C0G1H223J125AA Series= C0G/NP0	Cap= 22.0 nF VDC= 50.0 V IRMS= 0.0 A	1	\$0.08	 0805 7 mm ²
Cvcc	Taiyo Yuden	EMK107B7105KA-T Series= X7R	Cap= 1.0 uF ESR= 1.0 mOhm VDC= 16.0 V IRMS= 0.0 A	1	\$0.02	 0603 5 mm ²
D2	International Rectifier	30BQ060TRPBF	VF@Io= 580.0 mV VRRM= 60.0 V	1	NA	 SMC 83 mm ²
D3	Torex USA Corporation	XBS104S14R-G	VF@Io= 540.0 mV VRRM= 40.0 V	1	\$0.12	 SOD-123 13 mm ²
Dboot1	STMicroelectronics	STPS20M100SG-TR	VF@Io= 455.0 mV VRRM= 100.0 V	1	\$1.33	 DDPAK 210 mm ²
Dboot2	STMicroelectronics	STPS20M100SG-TR	VF@Io= 455.0 mV VRRM= 100.0 V	1	\$1.33	 DDPAK 210 mm ²
Df	International Rectifier	30BQ060TRPBF	VF@Io= 580.0 mV VRRM= 60.0 V	1	NA	 SMC 83 mm ²
L1	CUSTOM	CUSTOM	L= 12.01 uH 17.143 mOhm	1	NA	CUSTOM 0 mm ²
M1	Texas Instruments	CSD18543Q3A	VdsMax= 60.0 V IdsMax= 35.0 Amps	1	\$0.25	 DNH0008A 18 mm ²
M2	Texas Instruments	CSD19538Q2	VdsMax= 100.0 V IdsMax= 14.4 Amps	1	\$0.15	DQK0006C 9 mm ²

Name	Manufacturer	Part Number	Properties	Qty	Price	Footprint
M3	Texas Instruments	CSD17571Q2	VdsMax= 30.0 V IdsMax= 44.0 Amps	2	\$0.10	DQK0006C 9 mm ²
M4	Texas Instruments	CSD18543Q3A	VdsMax= 60.0 V IdsMax= 70.0 Amps	2	\$0.25	DNH0008A 18 mm ²
Rcomp	Vishay-Dale	CRCW04024K99FKED Series= CRCW..e3	Res= 4.99 kOhm Power= 63.0 mW Tolerance= 1.0%	1	\$0.01	0402 3 mm ²
Rcsg	Vishay-Dale	CRCW0603100RFKEA Series= CRCW..e3	Res= 100.0 Ohm Power= 100.0 mW Tolerance= 1.0%	1	\$0.01	0603 5 mm ²
Rcsp	Vishay-Dale	CRCW0603100RFKEA Series= CRCW..e3	Res= 100.0 Ohm Power= 100.0 mW Tolerance= 1.0%	1	\$0.01	0603 5 mm ²
Rf	Vishay-Dale	CRCW060310R0FKEA Series= CRCW..e3	Res= 10.0 Ohm Power= 100.0 mW Tolerance= 1.0%	1	\$0.01	0603 5 mm ²
Rfbb	Vishay-Dale	CRCW060320K0FKEA Series= CRCW..e3	Res= 20.0 kOhm Power= 100.0 mW Tolerance= 1.0%	1	\$0.01	0603 5 mm ²
Rfbt	Yageo	RC0603FR-07576KL Series= ?	Res= 576.0 kOhm Power= 100.0 mW Tolerance= 1.0%	1	\$0.01	0603 5 mm ²
Rmode	Vishay-Dale	CRCW060393K1FKEA Series= CRCW..e3	Res= 93.1 kOhm Power= 100.0 mW Tolerance= 1.0%	1	\$0.01	0603 5 mm ²
Rpg	Vishay-Dale	CRCW060320K0FKEA Series= CRCW..e3	Res= 20.0 kOhm Power= 100.0 mW Tolerance= 1.0%	1	\$0.01	0603 5 mm ²
Rsense	CUSTOM	CUSTOM Series= ?	Res= 4.6537 mOhm Power= 0.0 W Tolerance= 0.0%	1	NA	CUSTOM 0 mm ²
Rt	Vishay-Dale	CRCW0402267KFKED Series= CRCW..e3	Res= 267.0 kOhm Power= 63.0 mW Tolerance= 1.0%	1	\$0.01	0402 3 mm ²
Ruvb	Vishay-Dale	CRCW040247K5FKED Series= CRCW..e3	Res= 47.5 kOhm Power= 63.0 mW Tolerance= 1.0%	1	\$0.01	0402 3 mm ²
Ruvt	Yageo	RC0201FR-07249KL Series= ?	Res= 249.0 kOhm Power= 50.0 mW Tolerance= 1.0%	1	\$0.01	0201 2 mm ²
U1	Texas Instruments	LM5175QPWPRQ1	Switcher	1	\$3.22	PWP0028C_N 98 mm ²

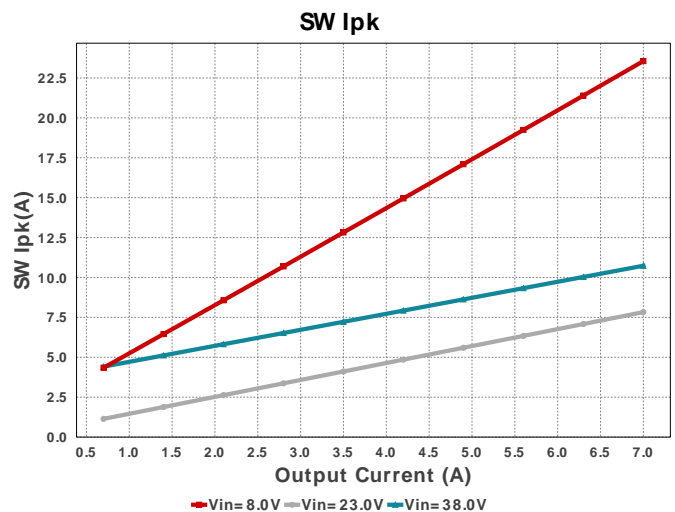
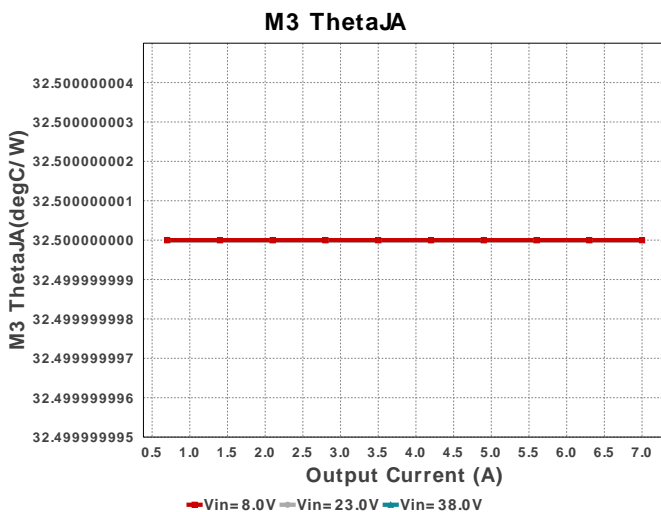

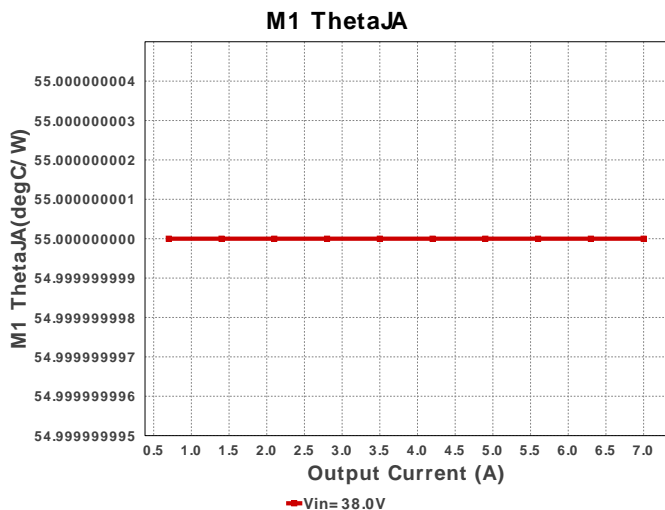
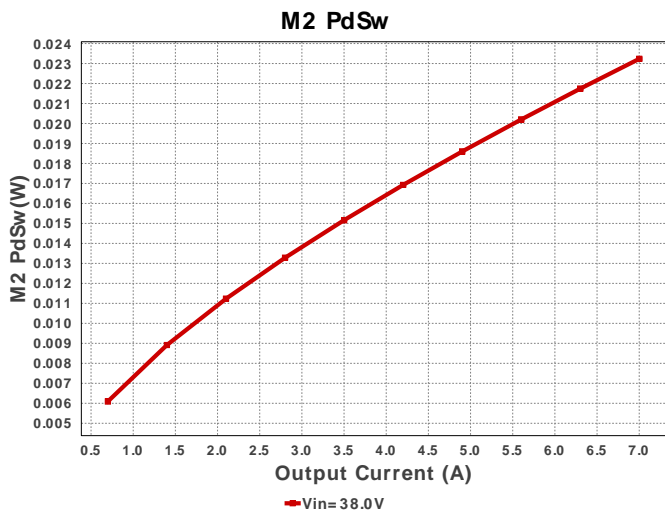
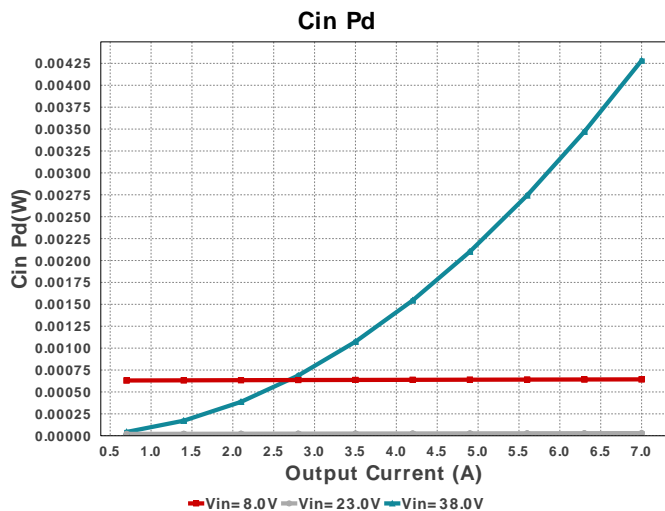
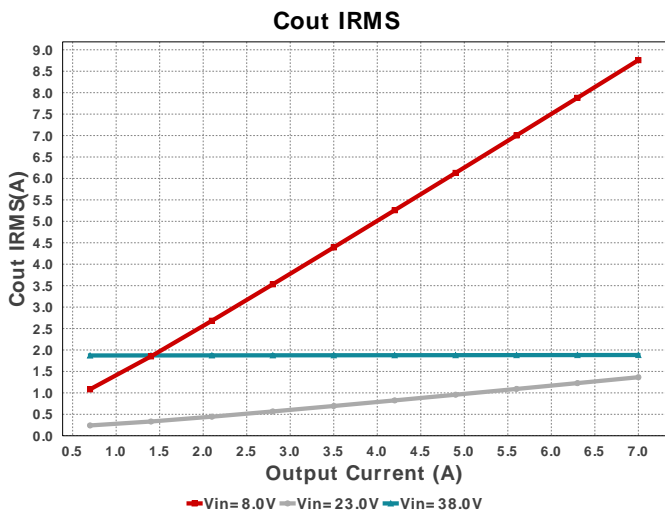
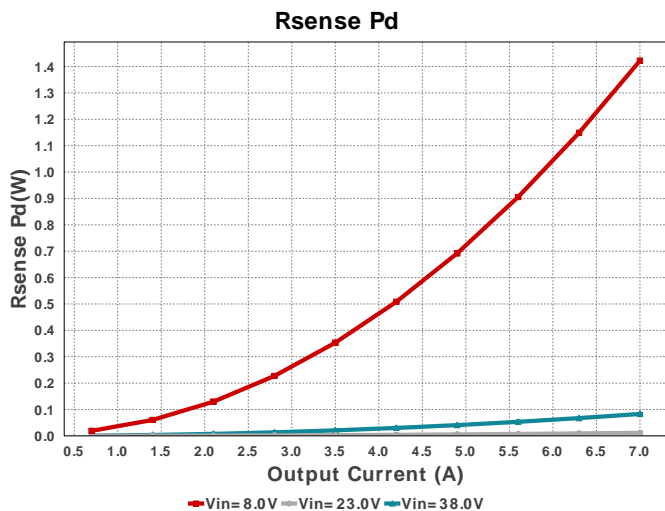
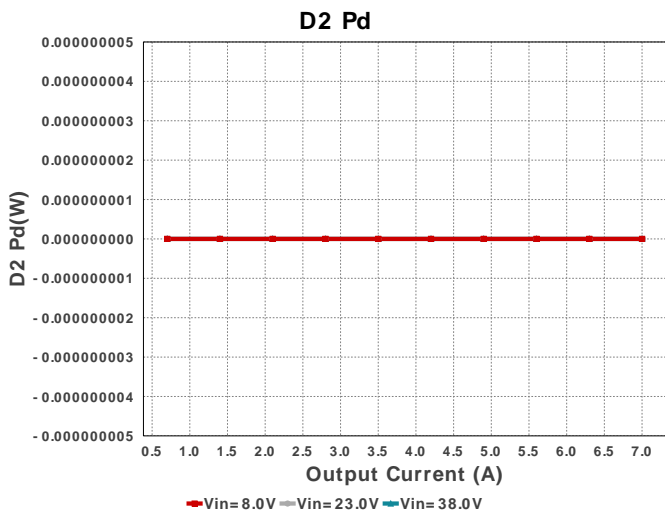

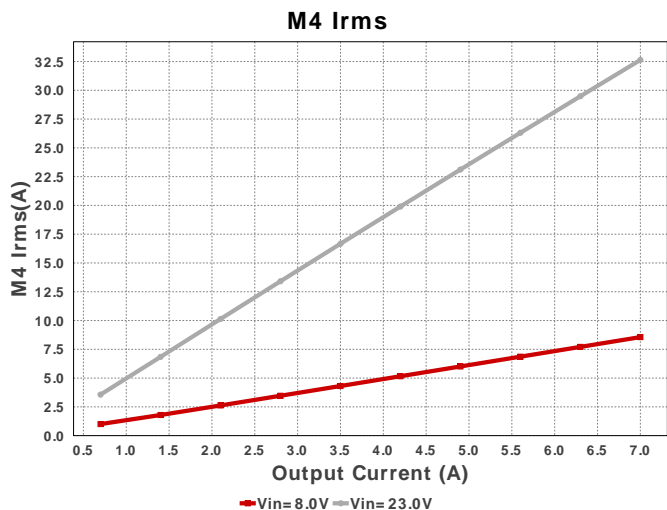
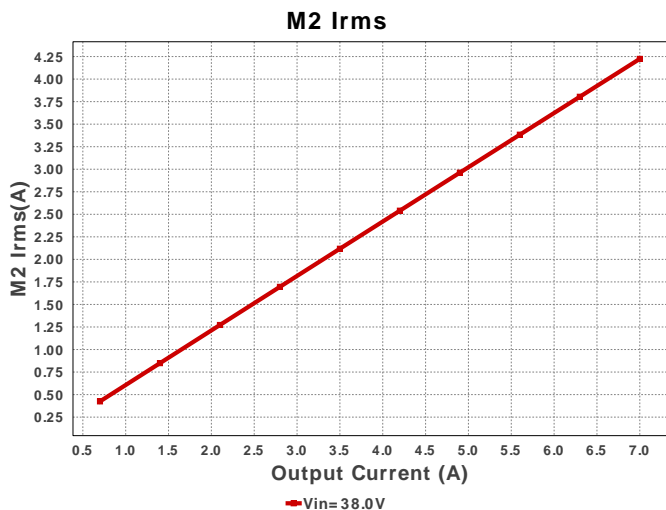
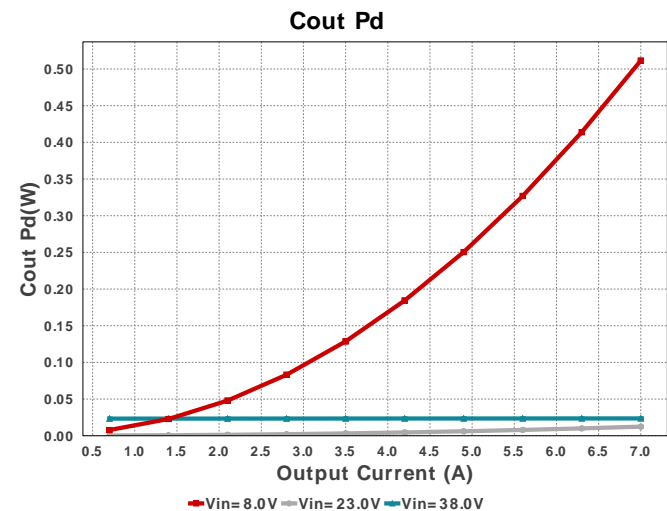
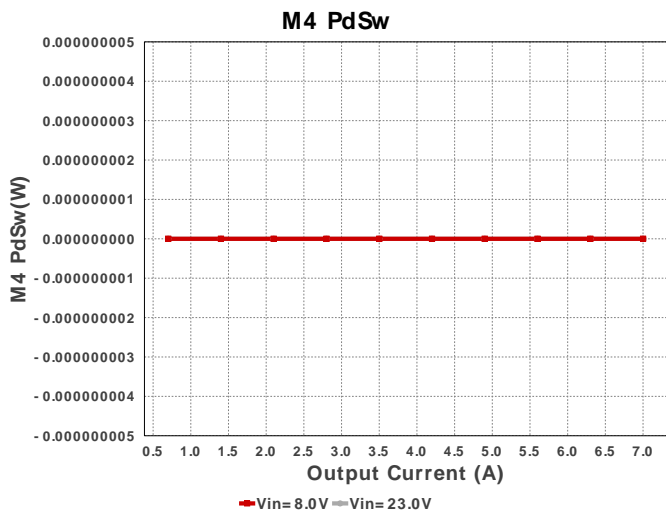
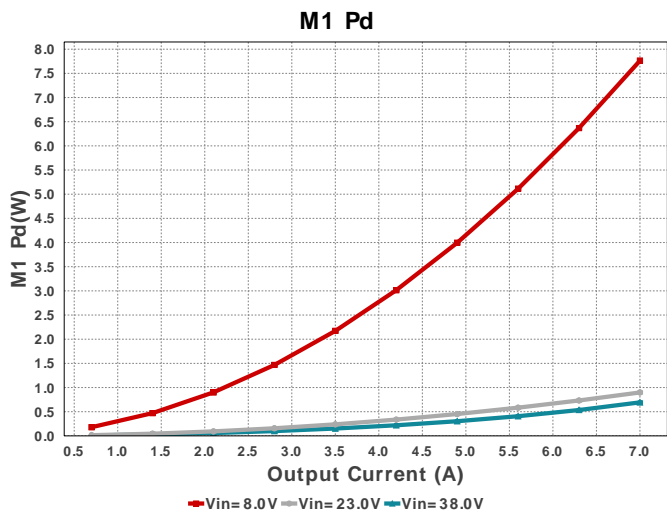
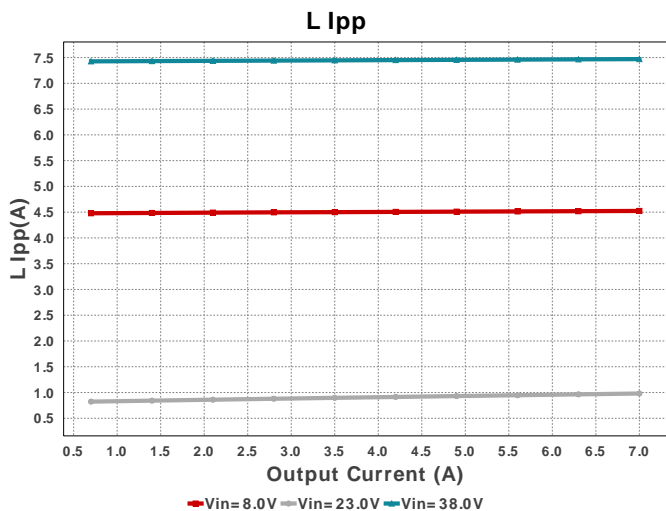

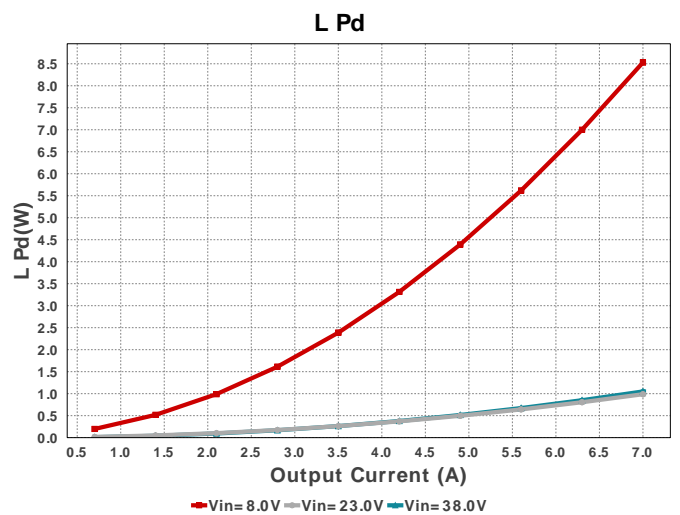
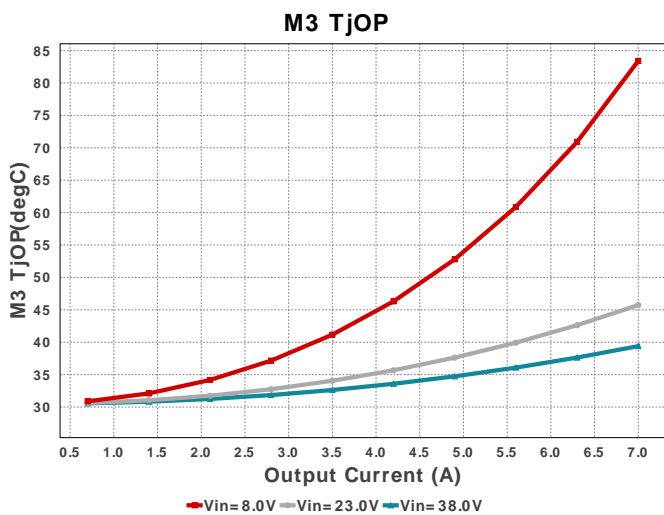
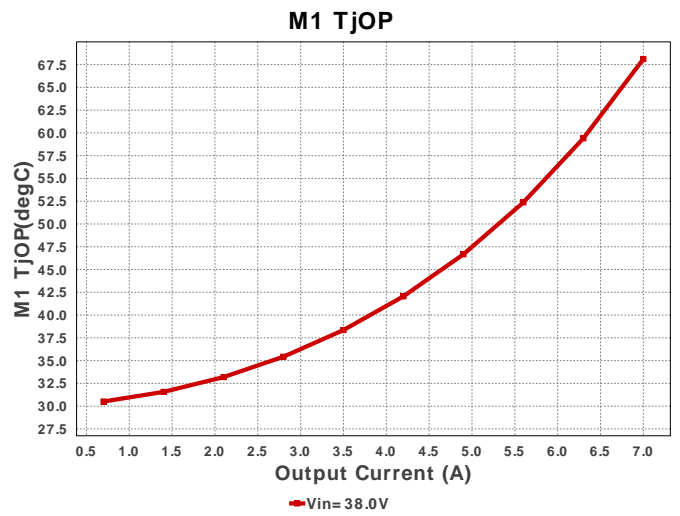
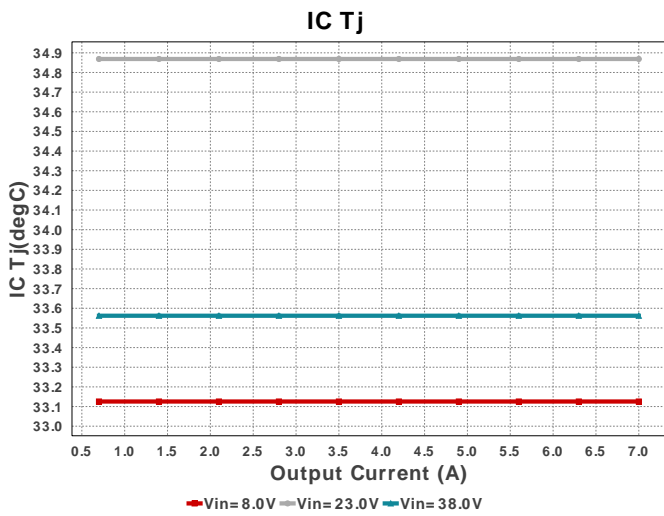
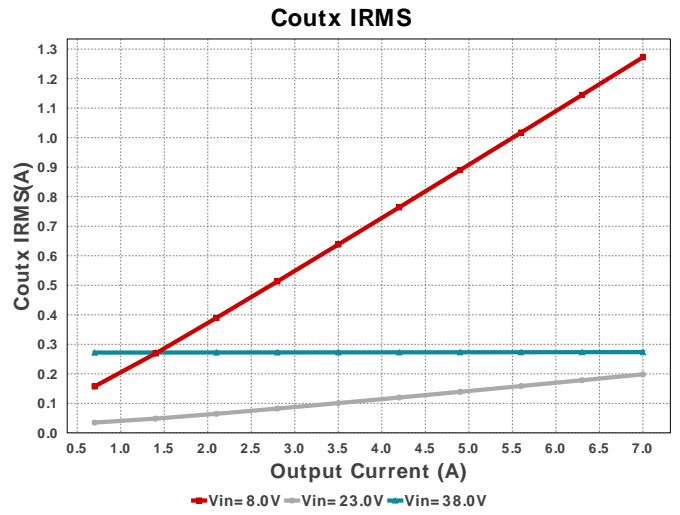
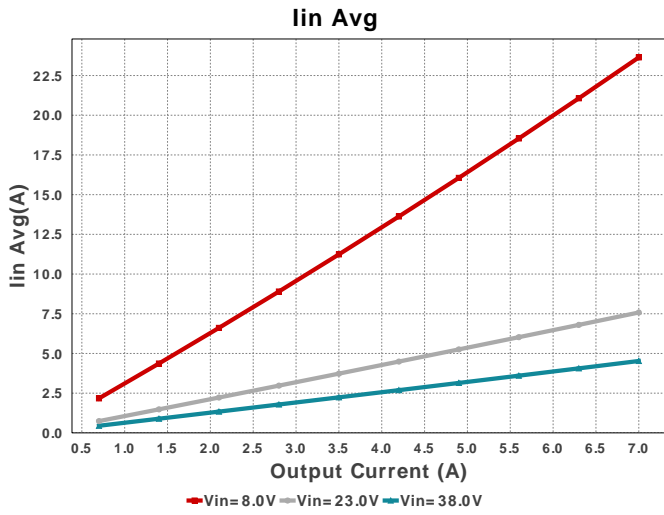

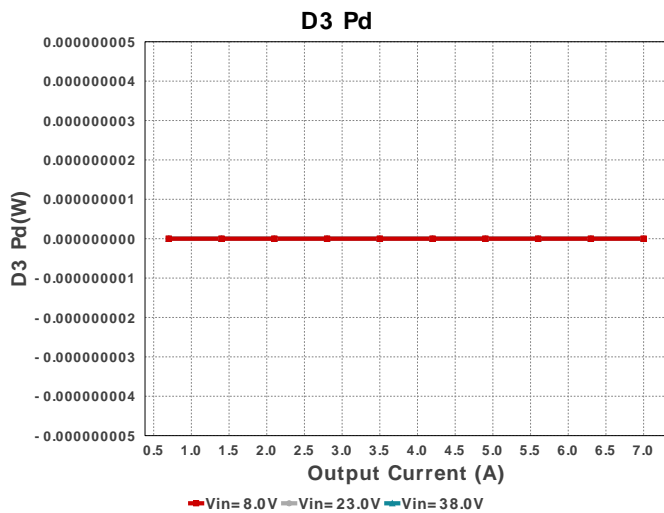
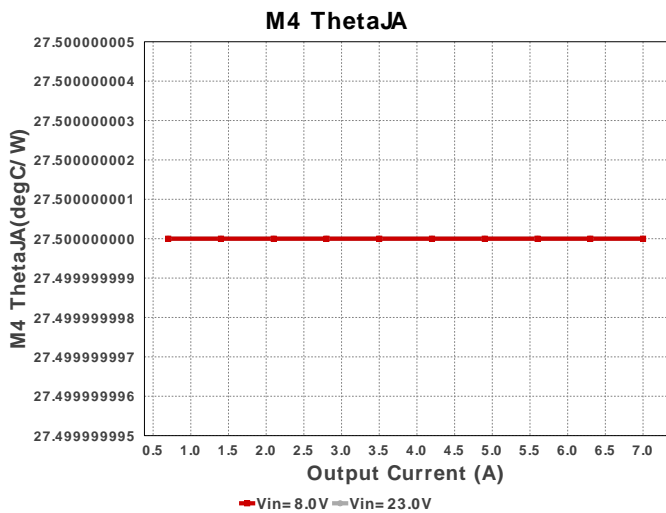
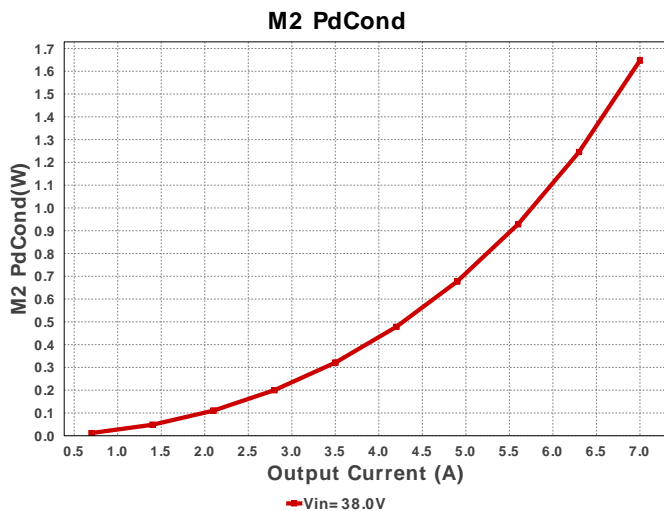
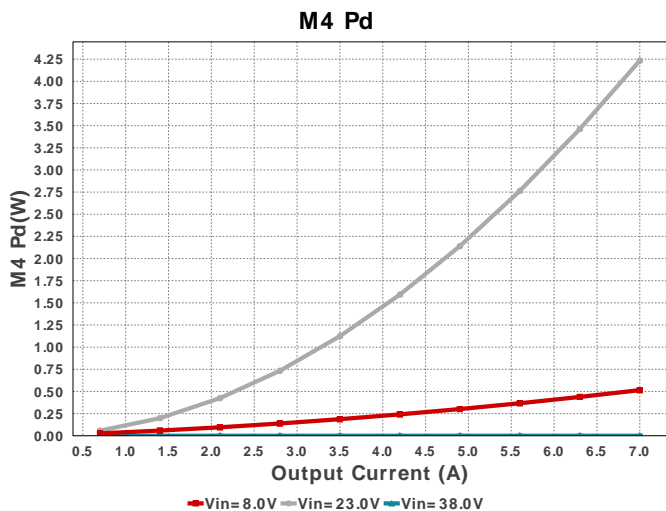
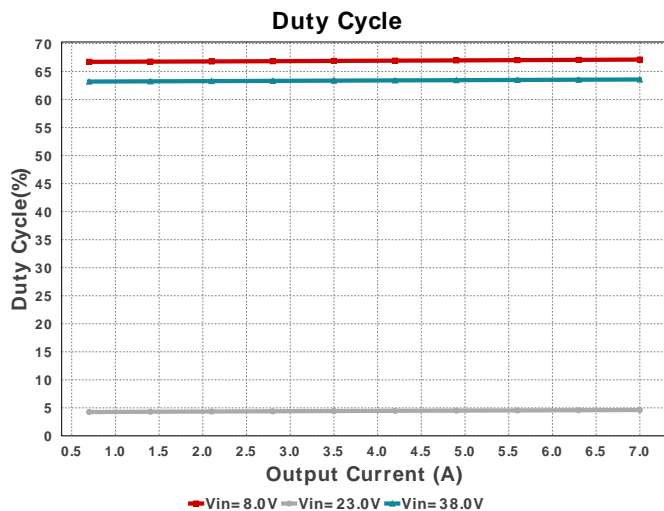
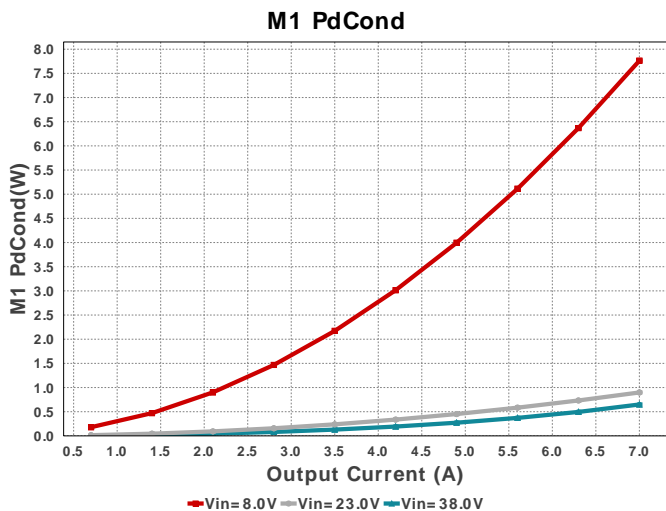

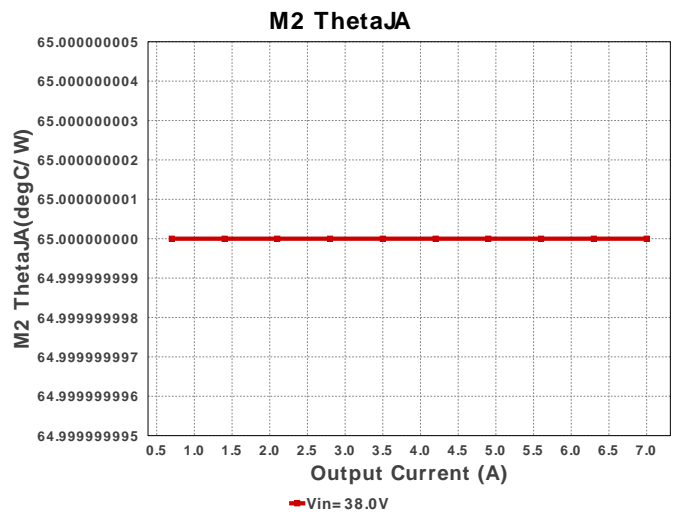
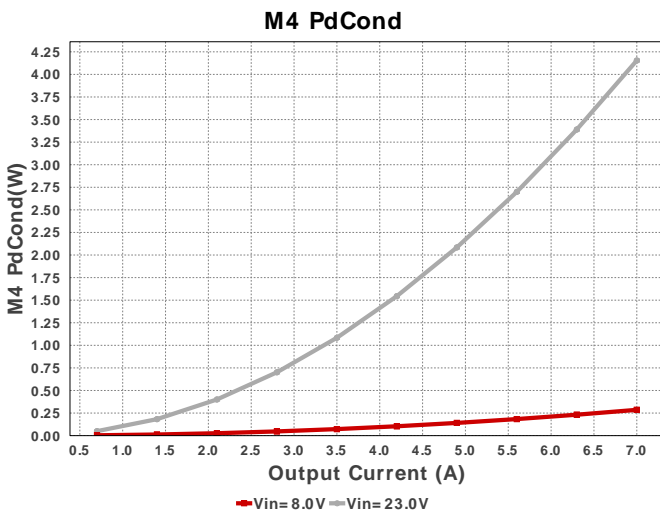
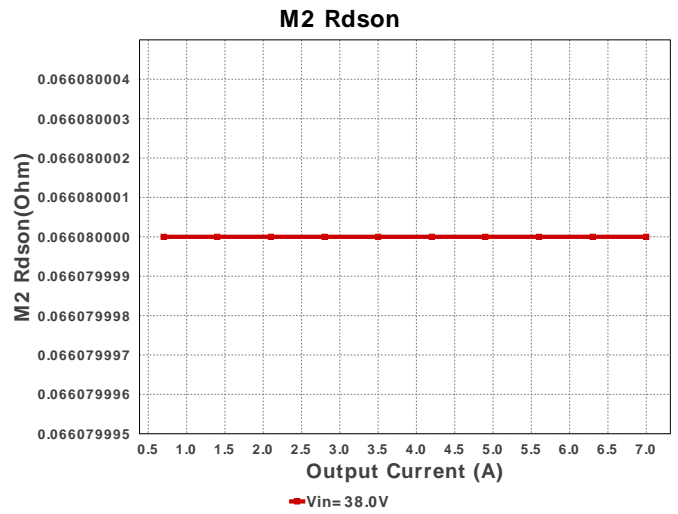
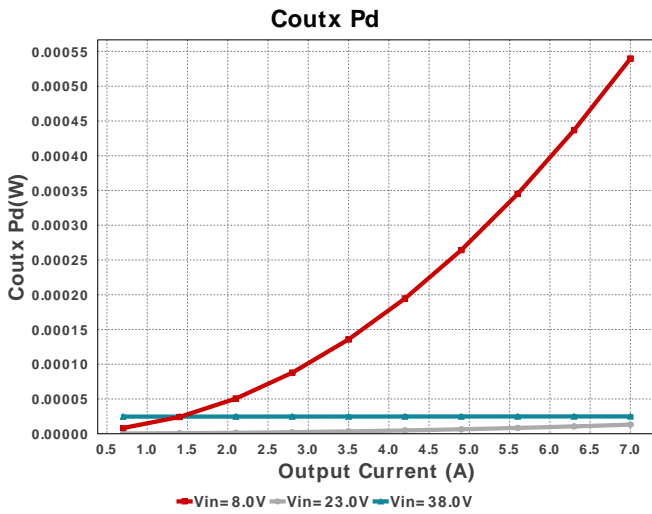
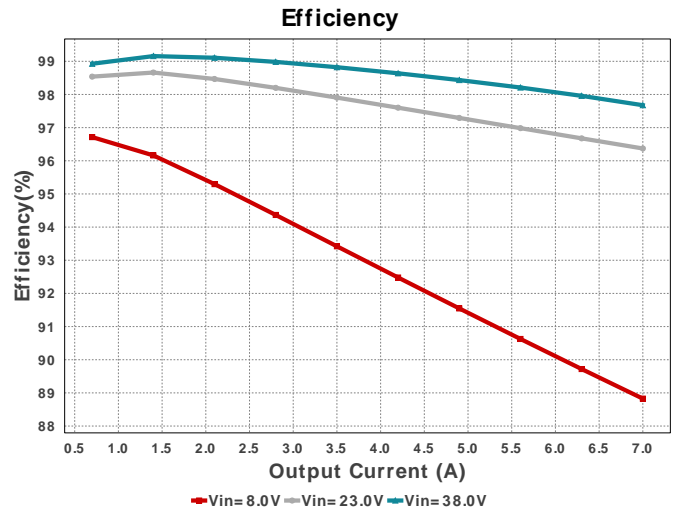
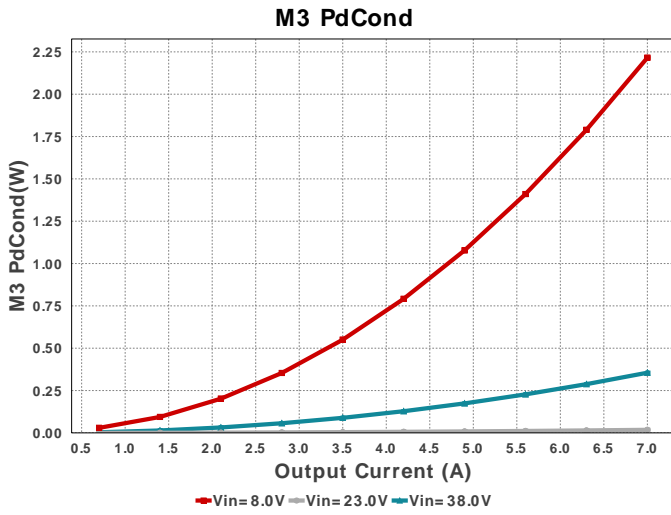

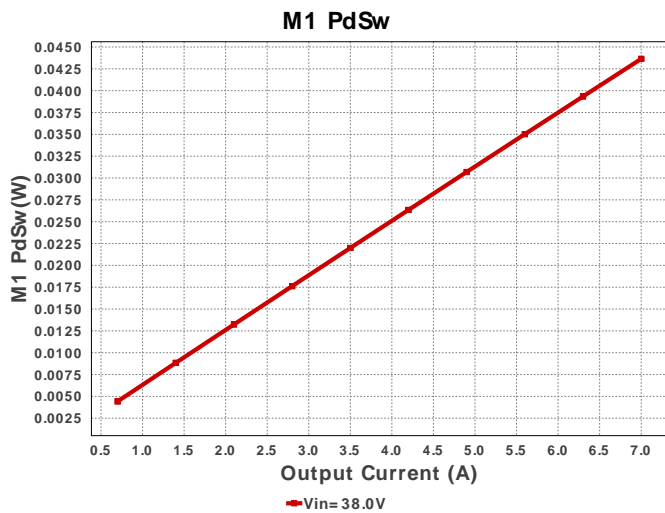
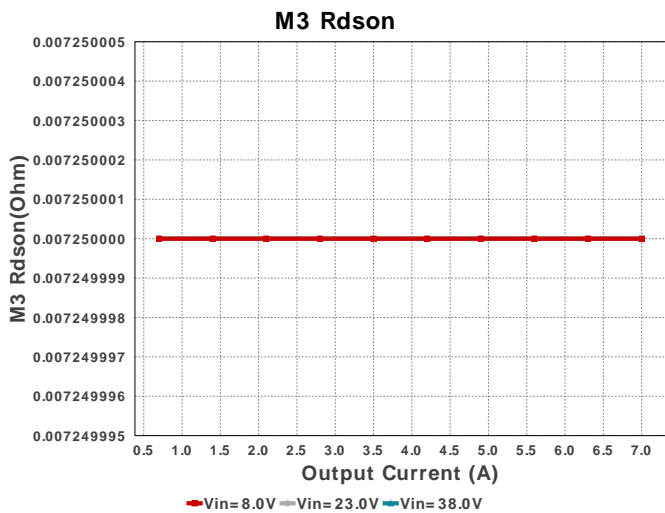
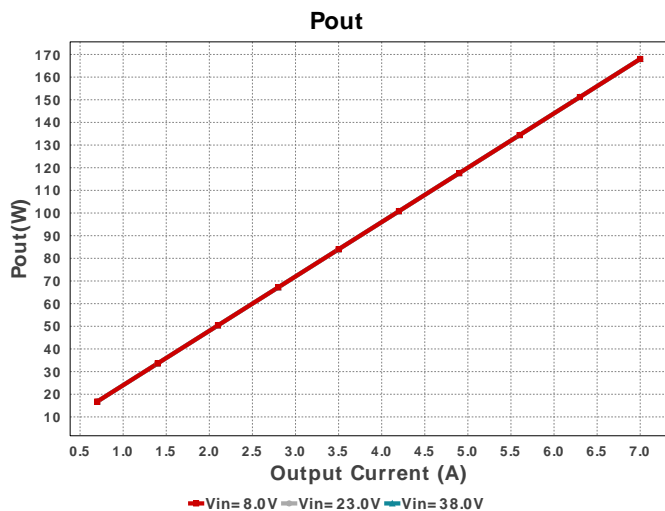
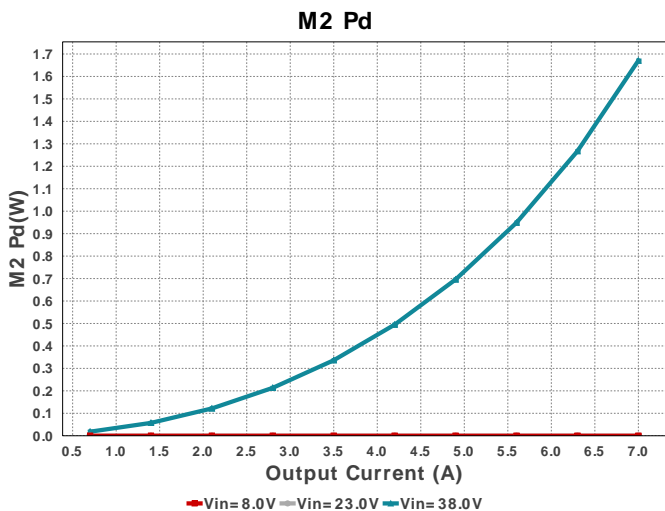
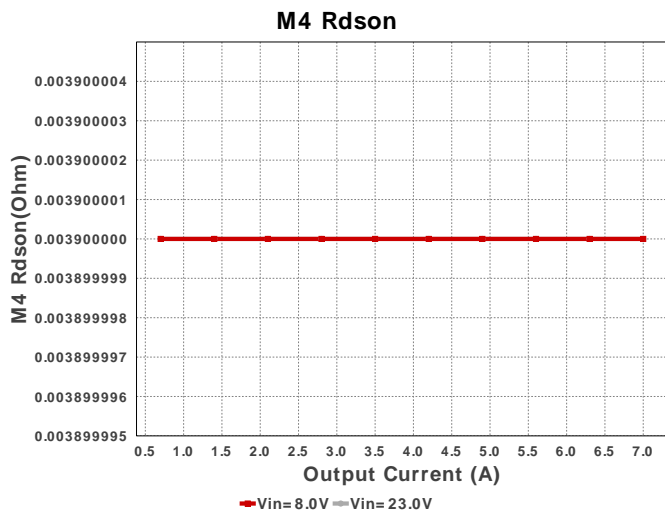
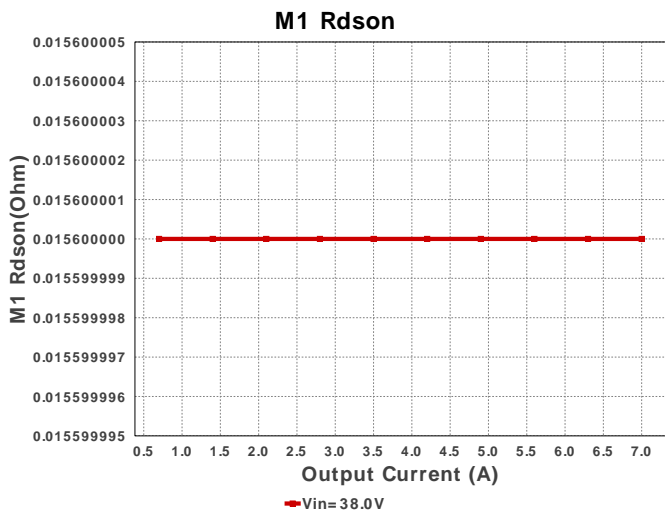

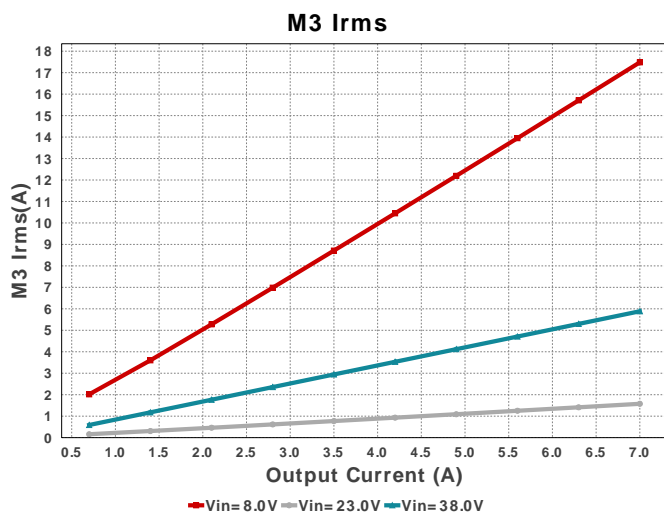
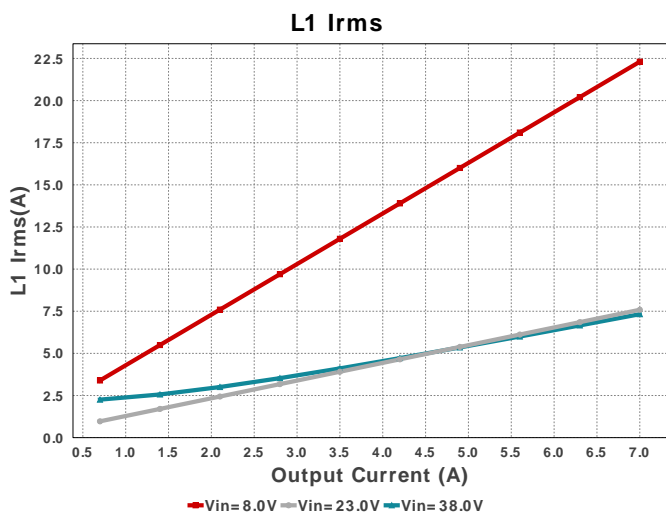
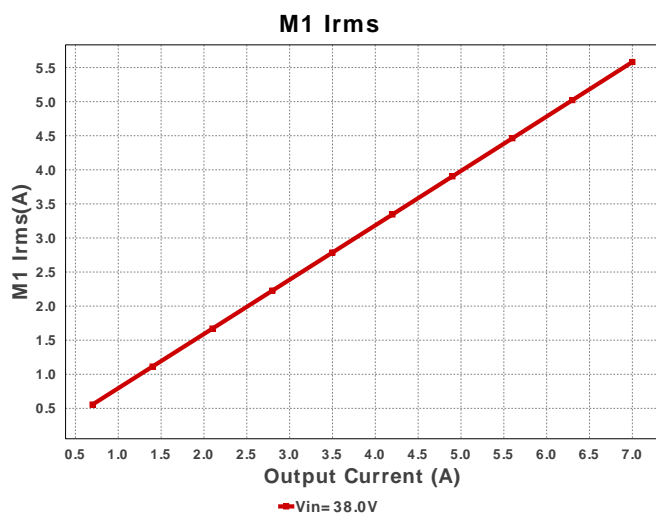
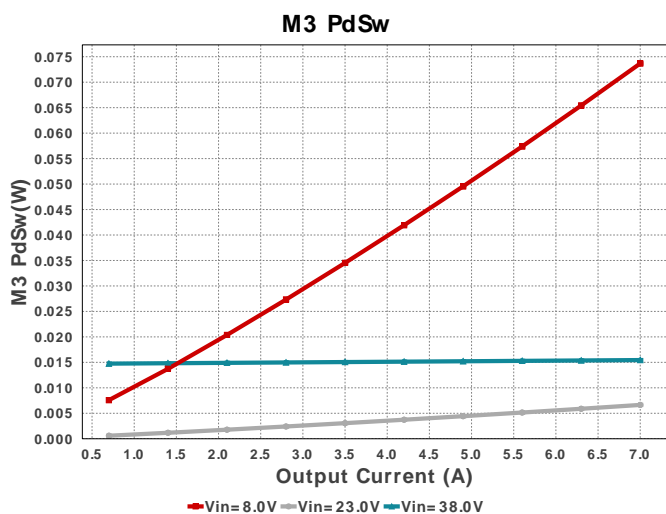
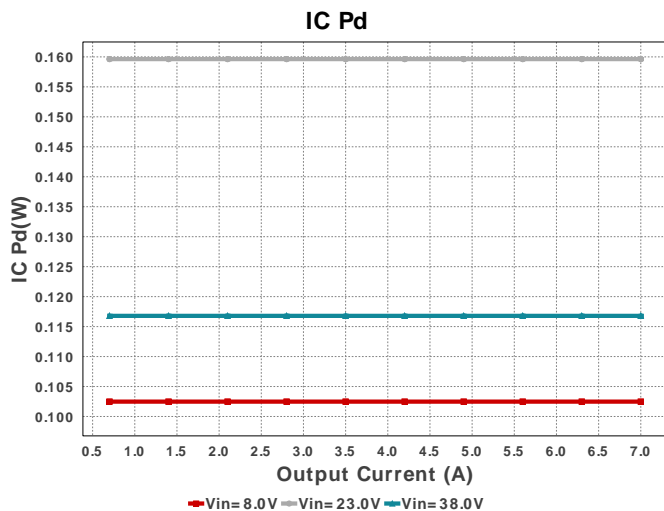
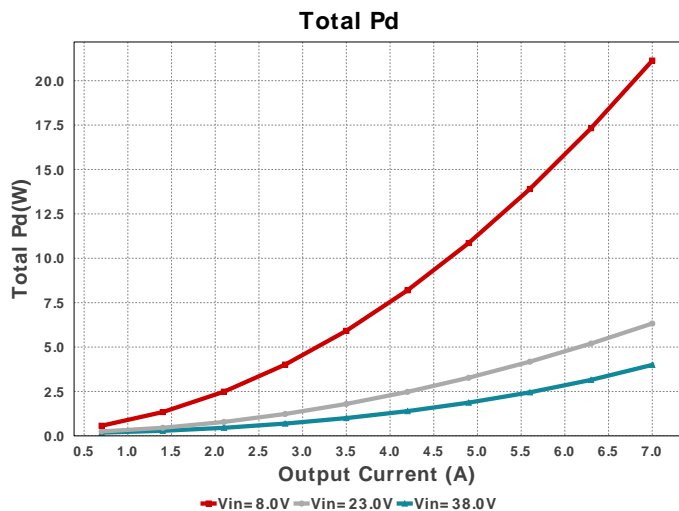

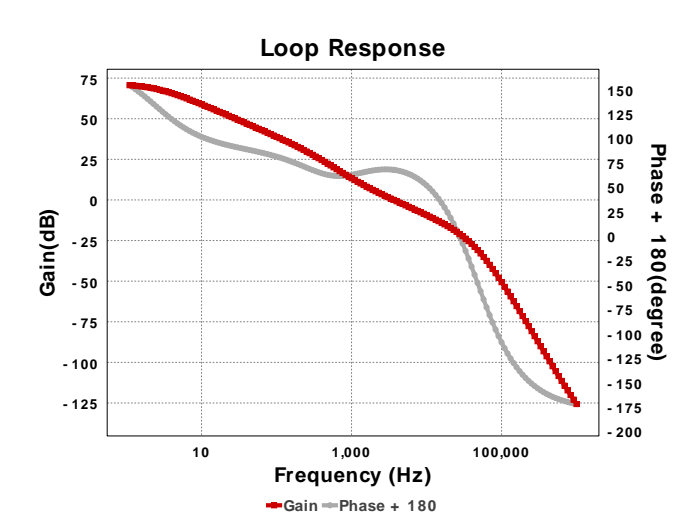
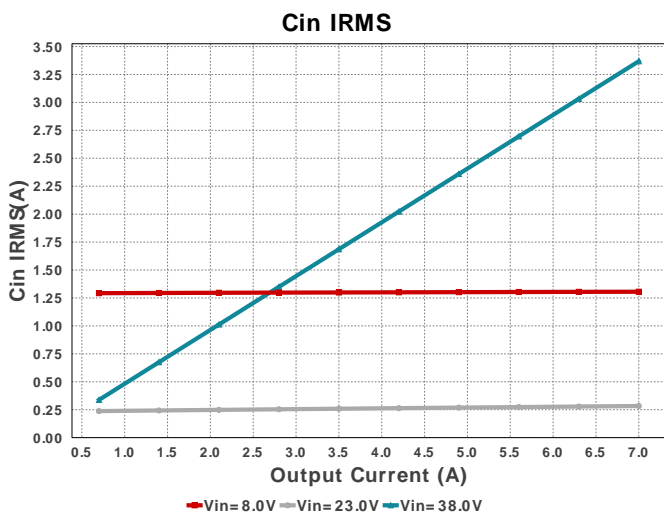
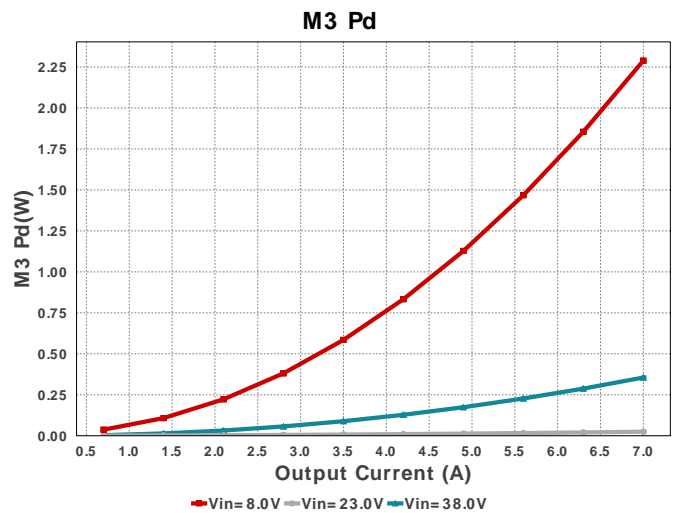
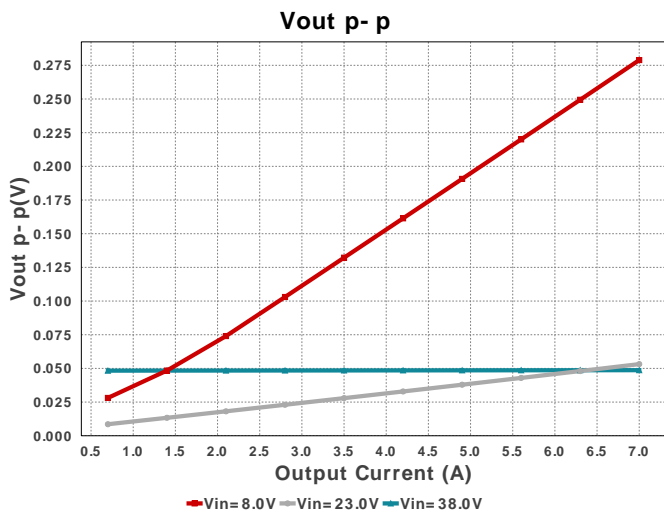
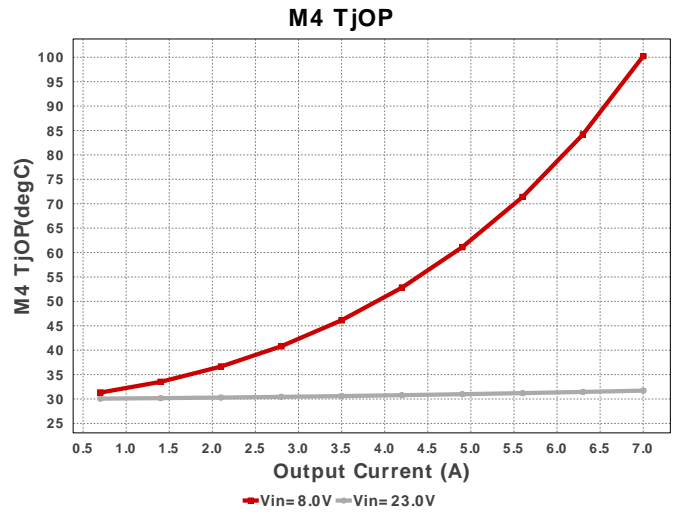
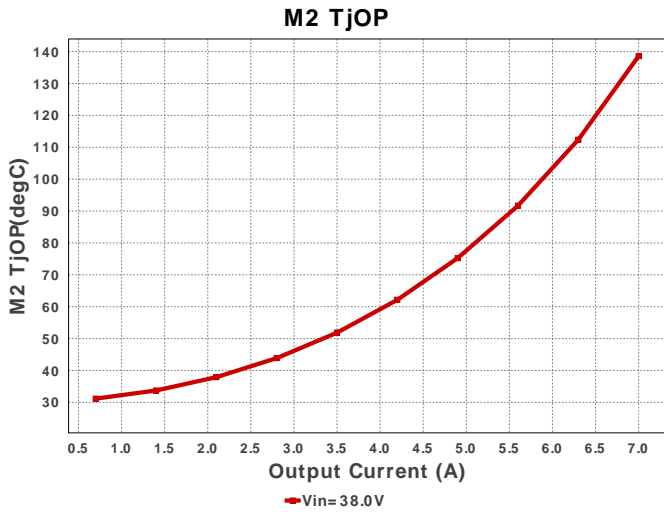

Operating Values

#	Name	Value	Category	Description
1.	Cin IRMS	1.306 A	Capacitor	Input capacitor RMS ripple current
2.	Cin Pd	643.54 μW	Capacitor	Input capacitor power dissipation
3.	Cout IRMS	8.759 A	Capacitor	Output capacitor RMS ripple current
4.	Cout Pd	511.47 mW	Capacitor	Output capacitor power dissipation
5.	Coutx IRMS	1.272 A	Capacitor	Output capacitor_x RMS ripple current
6.	Coutx Pd	539.73 μW	Capacitor	Output capacitor_x power loss
7.	D2 Pd	0.0 W	Diode	Diode power dissipation
8.	D3 Pd	0.0 W	Diode	Diode power dissipation
9.	IC Pd	216.78 mW	IC	IC power dissipation
10.	IC Tj	36.612 degC	IC	IC junction temperature
11.	IC Tolerance	12.0 mV	IC	IC Feedback Tolerance

#	Name	Value	Category	Description
12.	ICThetaJA	30.5 degC/W	IC	IC junction-to-ambient thermal resistance
13.	Iin Avg	23.656 A	IC	Average input current
14.	L Ipp	4.523 A	Inductor	Peak-to-peak inductor ripple current
15.	L Pd	8.529 W	Inductor	Inductor power dissipation
16.	L1 Irms	22.306 A	Inductor	Inductor ripple current
17.	M1 Pd	7.762 W	Mosfet	M1 MOSFET total power dissipation
18.	M1 PdCond	7.762 W	Mosfet	M1 MOSFET conduction losses
19.	M2 Pd	0.0 W	Mosfet	M2 MOSFET total power dissipation
20.	M3 Irms	17.481 A	Mosfet	MOSFET RMS ripple current
21.	M3 Pd	2.289 W	Mosfet	MOSFET power dissipation
22.	M3 PdCond	2.216 W	Mosfet	M1 MOSFET conduction losses
23.	M3 PdSw	73.676 mW	Mosfet	M1 MOSFET switching losses
24.	M3 ThetaJA	32.5 degC/W	Mosfet	MOSFET junction-to-ambient thermal resistance
25.	M3 TjOP	83.413 degC	Mosfet	MOSFET junction temperature
26.	M4 Irms	8.56 A	Mosfet	MOSFET RMS ripple current
27.	M4 Pd	514.93 mW	Mosfet	MOSFET power dissipation
28.	M4 PdCond	285.74 mW	Mosfet	M2 MOSFET conduction losses
29.	M4 PdSw	0.0 W	Mosfet	M2 MOSFET switching losses
30.	M4 ThetaJA	27.5 degC/W	Mosfet	MOSFET junction-to-ambient thermal resistance
31.	M4 TjOP	98.987 degC	Mosfet	MOSFET junction temperature
32.	M4 TjOP	98.987 degC	Mosfet	M4 MOSFET junction temperature
33.	Cin Pd	643.54 μW	Power	Input capacitor power dissipation
34.	Cout Pd	511.47 mW	Power	Output capacitor power dissipation
35.	Coutx Pd	539.73 μW	Power	Output capacitor_x power loss
36.	D2 Pd	0.0 W	Power	Diode power dissipation
37.	D3 Pd	0.0 W	Power	Diode power dissipation
38.	IC Pd	216.78 mW	Power	IC power dissipation
39.	L Pd	8.529 W	Power	Inductor power dissipation
40.	M1 Pd	7.762 W	Power	M1 MOSFET total power dissipation
41.	M1 PdCond	7.762 W	Power	M1 MOSFET conduction losses
42.	M2 Pd	0.0 W	Power	M2 MOSFET total power dissipation
43.	M3 Pd	2.289 W	Power	MOSFET power dissipation
44.	M3 PdCond	2.216 W	Power	M1 MOSFET conduction losses
45.	M3 PdSw	73.676 mW	Power	M1 MOSFET switching losses
46.	M3 Rdson	7.25 mOhm	Power	Drain-Source On-resistance
47.	M4 Pd	514.93 mW	Power	MOSFET power dissipation
48.	M4 PdCond	285.74 mW	Power	M2 MOSFET conduction losses
49.	M4 PdSw	0.0 W	Power	M2 MOSFET switching losses
50.	M4 Rdson	3.9 mOhm	Power	Drain-Source On-resistance
51.	Rsense Pd	1.422 W	Power	LED Current Rsns Power Dissipation
52.	Total Pd	21.247 W	Power	Total Power Dissipation
53.	Rsense Pd	1.422 W	Resistor	LED Current Rsns Power Dissipation
54.	BOM Count	55	System	Total Design BOM count
55.	Cross Freq	3.643 kHz	System Information	Bode plot crossover frequency
56.	Duty Cycle	67.13 %	System Information	Duty cycle
57.	Efficiency	88.773 %	System Information	Steady state efficiency
58.	FootPrint	2.741 k mm ²	System Information	Total Foot Print Area of BOM components
59.	Frequency	99.216 kHz	System Information	Switching frequency
60.	Gain Marg	-21.05 dB	System Information	Bode Plot Gain Margin
61.	Iout	7.0 A	System Information	Iout operating point
62.	Low Freq Gain	70.629 dB	System Information	Gain at 1Hz
63.	Mode	CCM	System Information	Conduction Mode
64.	Operating Topology	Boost	System Information	The current operating topology of the device
65.	Phase Marg	68.753 deg	System Information	Bode Plot Phase Margin
66.	Pout	168.0 W	System Information	Total output power
67.	SW Ipk	23.557 A	System Information	Peak switch current
68.	Total BOM	NA	System Information	Total BOM Cost
69.	Vin	8.0 V	System Information	Vin operating point
70.	Vout	24.0 V	System Information	Operational Output Voltage

#	Name	Value	Category	Description
71.	Vout Actual	23.84 V	System Information	Vout Actual calculated based on selected voltage divider resistors
72.	Vout Tolerance	3.482 %	System Information	Vout Tolerance based on IC Tolerance (no load) and voltage divider resistors if applicable
73.	Vout p-p	278.903 mV	System Information	Peak-to-peak output ripple voltage

Design Inputs

Name	Value	Description
Iout	7.0	Maximum Output Current
VinMax	38.0	Maximum input voltage
VinMin	8.0	Minimum input voltage
Vout	24.0	Output Voltage
base_pn	LM5175-Q1	Base Product Number
source	DC	Input Source Type
Ta	30.0	Ambient temperature

WEBENCH® Assembly

Component Testing

Some published data on components in datasheets such as Capacitor ESR and Inductor DC resistance is based on conservative values that will guarantee that the components always exceed the specification. For design purposes it is usually better to work with typical values. Since this data is not always available it is a good practice to measure the Capacitance and ESR values of C_{in} and C_{out} , and the inductance and DC resistance of L1 before assembly of the board. Any large discrepancies in values should be electrically simulated in WEBENCH to check for instabilities and thermally simulated in WebTHERM to make sure critical temperatures are not exceeded.

Soldering Component to Board

If board assembly is done in house it is best to tack down one terminal of a component on the board then solder the other terminal. For surface mount parts with large tabs, such as the DPAK, the tab on the back of the package should be pre-tinned with solder, then tacked into place by one of the pins. To solder the tab down to the board place the iron down on the board while resting against the tab, heating both surfaces simultaneously. Apply light pressure to the top of the plastic case until the solder flows around the part and the part is flush with the PCB. If the solder is not flowing around the board you may need a higher wattage iron (generally 25W to 30W is enough).

Initial Startup of Circuit

It is best to initially power up the board by setting the input supply voltage to the lowest operating input voltage 8.0V and set the input supply's current limit to zero. With the input supply off connect up the input supply to V_{in} and GND. Connect a digital volt meter and a load if needed to set the minimum load of the design from V_{out} and GND. Turn on the input supply and slowly turn up the current limit on the input supply. If the voltage starts to rise on the input supply continue increasing the input supply current limit while watching the output voltage. If the current increases on the input supply, but the voltage remains near zero, then there may be a short or a component misplaced on the board. Power down the board and visually inspect for solder bridges and recheck the diode and capacitor polarities. Once the power supply circuit is operational then more extensive testing may include full load testing, transient load and line tests to compare with simulation results.

Load Testing

The setup is the same as the initial startup, except that an additional digital voltmeter is connected between V_{in} and GND, a load is connected between V_{out} and GND and a current meter is connected in series between V_{out} and the load. The load must be able to handle at least rated output power + 50% (7.5 watts for this design). Ideally the load is supplied in the form of a variable load test unit. It can also be done in the form of suitably large power resistors. When using an oscilloscope to measure waveforms on the prototype board, the ground leads of the oscilloscope probes should be as short as possible and the area of the loop formed by the ground lead should be kept to a minimum. This will help reduce ground lead inductance and eliminate EMI noise that is not actually present in the circuit.



WEBENCH® Electrical Simulation Report

Design Id = 22

sim_id = 3

Simulation Type = Steady State

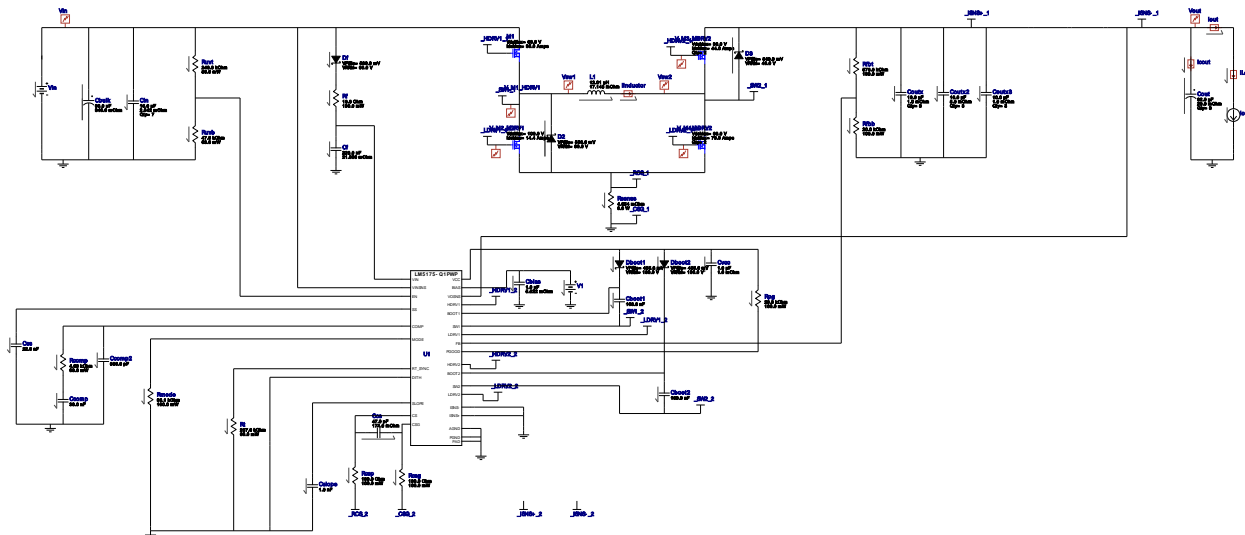

Simulation Parameters

#	Name	Parameter Name	Description	Values
1.	Css	IC	Initial Voltage	1.195 V
2.	Cout	IC	no description	24.0 V
3.	Coutx3	IC	no description	24.0 V
4.	L1	IC	Initial Current	-8.593350383631714 A
5.	V1	V	Bias Voltage	9 V
6.	Coutx2	IC	no description	24.0 V
7.	Coutx	IC	Initial Condition	24.0
8.	Iout	I	Load Current	7.0 A

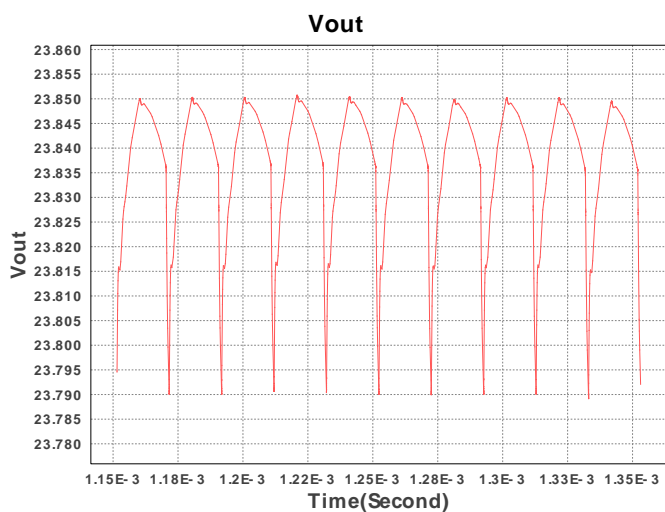

Design Assistance

1. The LM5175-Q1 is qualified for Automotive applications. All passives and other components selected in this design may not be qualified for Automotive applications. The user is required to verify that all components in the design meet the qualification and safety requirements for their specific application.

2. Tip: Snubbers and/or gate resistors may be required to limit the SW1,2 node switching spikes below the IC and FET abs max ratings.
3. Tip: Slope Capacitor: smaller slope capacitors provide better transition region behavior.
4. Master key : 1829CD4225D4E1D6[v1]
5. **LM5175-Q1** Product Folder : <http://www.ti.com/product/LM5175%2DQ1> : contains the data sheet and other resources.

Important Notice and Disclaimer

TI provides technical and reliability data (including datasheets), design resources (including reference designs), application or other design advice, web tools, safety information, and other resources AS IS and with all faults, and disclaims all warranties. These resources are intended for skilled developers designing with TI products. You are solely responsible for (1) selecting the appropriate TI products for your application, (2) designing, validating and testing your application, and (3) ensuring your application meets applicable standards, and any other safety, security, or other requirements.

These resources are subject to change without notice. TI grants you permission to use these resources only for development of an application that uses the TI products described in the resource. Other reproduction and display of these resources is prohibited. No license is granted to any other TI intellectual property right or to any third party intellectual property right. TI disclaims responsibility for, and you will fully indemnify TI and its representatives against, any claims, damages, costs, losses, and liabilities arising out of your use of these resources.

Providing these resources does not expand or otherwise alter TI's applicable Terms of Sale or other applicable terms available either on ti.com or provided in conjunction with TI products.